



AgEcon SEARCH
RESEARCH IN AGRICULTURAL & APPLIED ECONOMICS

The World's Largest Open Access Agricultural & Applied Economics Digital Library

This document is discoverable and free to researchers across the globe due to the work of AgEcon Search.

Help ensure our sustainability.

Give to AgEcon Search

AgEcon Search

<http://ageconsearch.umn.edu>

aesearch@umn.edu

*Papers downloaded from **AgEcon Search** may be used for non-commercial purposes and personal study only. No other use, including posting to another Internet site, is permitted without permission from the copyright owner (not AgEcon Search), or as allowed under the provisions of Fair Use, U.S. Copyright Act, Title 17 U.S.C.*

Evaluation of Current and Future Water Resources Development in the Lake Tana Basin, Ethiopia

Matthew McCartney, Tadesse Alemayehu, Abeyu Shiferaw and Seleshi Bekele Awulachew



Research Reports

The publications in this series cover a wide range of subjects—from computer modeling to experience with water user associations—and vary in content from directly applicable research to more basic studies, on which applied work ultimately depends. Some research reports are narrowly focused, analytical and detailed empirical studies; others are wide-ranging and synthetic overviews of generic problems.

Although most of the reports are published by IWMI staff and their collaborators, we welcome contributions from others. Each report is reviewed internally by IWMI staff, and by external reviewers. The reports are published and distributed both in hard copy and electronically (www.iwmi.org) and where possible all data and analyses will be available as separate downloadable files. Reports may be copied freely and cited with due acknowledgment.

About IWMI

IWMI's mission is to improve the management of land and water resources for food, livelihoods and the environment. In serving this mission, IWMI concentrates on the integration of policies, technologies and management systems to achieve workable solutions to real problems—practical, relevant results in the field of irrigation and water and land resources.

IWMI Research Report 134

Evaluation of Current and Future Water Resources Development in the Lake Tana Basin, Ethiopia

Matthew McCartney, Tadesse Alemayehu, Abeyu Shiferaw and Seleshi Bekele Awulachew

International Water Management Institute
P O Box 2075, Colombo, Sri Lanka

The authors: Matthew McCartney is a senior researcher specializing in hydrology and water resource management at the subregional office for East Africa and the Nile Basin of the International Water Management Institute (IWMI) in Addis Ababa, Ethiopia (email: m.mccartney@cgiar.org); Tadesse Alemayehu was an independent consultant in Addis Ababa when this report was prepared and is now a lecturer at the University of Bahir Dar, Ethiopia. Abeyu Shiferaw was an independent consultant in Addis Ababa, Ethiopia when this report was prepared and is now the coordinator of an international Nuffic project on integrated river basin management at Addis Ababa University; and Seleshi Bekele Awulachew is a senior researcher and the regional representative for the East Africa and Nile Basin office of the International Water Management Institute in Addis Ababa, Ethiopia.

McCartney, M.; Alemayehu, T.; Shiferaw, A.; Awulachew, S. B. 2010. *Evaluation of current and future water resources development in the Lake Tana Basin, Ethiopia*. Colombo, Sri Lanka: International Water Management Institute. 39p. (IWMI Research Report 134). doi:10.3910/2010.204

/ water resources development / lakes / dams / environmental flows / hydrology / stakeholders / models / irrigation / hydropower / Ethiopia /

ISSN 1026-0862
ISBN 978-92-9090-721-3

Copyright © 2010, by IWMI. All rights reserved. IWMI encourages the use of its material provided that the organization is acknowledged and kept informed in all such instances.

Cover photograph shows the shoreline of Lake Tana, Ethiopia (*photo credit:* Matthew McCartney)

Please send inquiries and comments to: iwmi@cgiar.org

A free copy of this publication can be downloaded at
www.iwmi.org/Publications/IWMI_Research_Reports/index.aspx

Acknowledgements

The authors would like to thank Ayalew Gebre and Derese Getachew of Addis Ababa University for their assistance in conducting the stakeholder review. They are grateful to the Ethiopian Electric Power Corporation, the Federal Ministry of Water Resources, the National Meteorological Agency and the Central Statistical Agency of Ethiopia for the provision of data.

Project



This report presents findings from project number 36 entitled “Improved Planning of Large Dam Operation: Using Decision Support Systems to Optimize Livelihood Benefits, Safeguard Health and Protect the Environment” of the CGIAR Challenge Program on Water and Food (CPWF).

The following organizations collaborated in the research conducted for this report.



International Water Management Institute, Addis Ababa, Ethiopia



Addis-Ababa University, Addis Ababa, Ethiopia



Southern Waters, Cape Town, South Africa

Water scarcity is one of the most pressing issues facing humanity today. The Challenge Program on Water and Food (CPWF), an initiative of the Consultative Group on International Agricultural Research (CGIAR), contributes to efforts of the international community to ensure global diversions of water to agriculture are maintained at the level of the year 2000. It is a multiinstitutional research initiative that aims to increase water productivity for agriculture—that is, to change the way water is managed and used to meet international food security and poverty eradication goals—and to leave more water for other users and the environment.

The CPWF deals with complex agriculture-related systems, for which there are a growing number of stakeholders generating information. Its community-of-practice works in innovative ways to collate, unify, organize, extract, distill and share the ideas, information and knowledge to allow next-users to gain insights and deduce principles, concepts and cause-and-effect relationships from its research results. To help achieve this, the CPWF focuses on building multi-disciplinary north-south and south-south partnerships.

www.waterandfood.org

Contents

Acronyms and Abbreviations	vi
Summary	vii
Introduction	1
The Study Area	2
Impacts of the Chara Chara Weir on Lake Tana Outflow and Environmental Flow Assessment	6
Stakeholder Analysis of the Chara Chara Weir	15
Simulation of Future Water Resources Development	19
Discussion	26
Concluding Remarks	28
References	29

Acronyms and Abbreviations

ARBWR	Amhara Region - Bureau of Water Resources
BCEOM	Egis Bceom International
BS	Baseline Scenario
DRM	Desktop Reserve Model
EEPCO	Ethiopian Electric Power Corporation
EELPA	Ethiopian Electricity Light and Power Authority
EIA	Environmental Impact Assessment
EPLAUA	Environmental Protection, Land Administration and Use Authority
EU	European Union
FDS	Full Development Scenario
LDS	Likely Development Scenario
LTBRC	Lake Tana Basin Research Centre
ODS	Ongoing Development Scenario
PaDPA	Amhara Parks Development and Protection Authority
TBF	Tana Beles Flow
VEF	Variable Environmental Flow
WEAP	Water Evaluation And Planning (Model)

Summary

Lake Tana is valuable for many people, including the communities who live around the lakeshore, those living on islands and close to the Blue Nile River, which flows from it. The area has been identified as a region for irrigation and hydropower development, which are vital for food security and economic growth in Ethiopia. This report presents findings from an integrated multidisciplinary study that was conducted to investigate the implications of this development. The study comprised three components: i) an environmental flow evaluation; ii) a stakeholder analysis of the impact of current infrastructure and water management; and iii) computer modeling of future water resources development. The study found that existing water resources development, for hydropower generation, has modified flows downstream of the lake, reduced water levels of the lake and significantly decreased flow over the Tis Issat Waterfall. Interviews with stakeholders indicate that the changes have benefited some people but have

adversely affected others. Future development will exacerbate pressure on the lake. If all the planned development occurs, the mean water level of the lake will drop by 0.44 meters (m), and the average surface area will decrease by 30 square kilometers (km²) (i.e., 1%) and up to 81 km² (i.e., 2.6%) during some dry seasons. There will be prolonged periods of several years during which water levels will be much lower than they would be naturally. If environmental flow requirements (estimated to average 862 Mm³y⁻¹) are maintained in the reach containing the Tis Issat Waterfall, the mean water level of the lake will reduce by a further 0.37 m and the average lake area will reduce by an additional 26 km². Without careful management these changes are likely to have severe ecological and social consequences. Hard choices must be made about how the water is best utilized. It is important that all stakeholders, including local people, are involved in the decision-making process and benefit from investments.

Evaluation of Current and Future Water Resources Development in the Lake Tana Basin, Ethiopia

Matthew McCartney, Tadesse Alemayehu, Abeyu Shiferaw and Seleshi Bekele Awulachew

Introduction

Effective water resources development is widely recognized as crucial for sustainable economic growth and poverty reduction in developing countries (World Bank 2004; Grey and Sadoff 2006). However, such development incurs costs as well as benefits. In the past, large hydraulic infrastructure as well as water transfers, from one catchment to another, has resulted in unforeseen environmental and social costs, which in some instances outweigh the benefits (WCD 2000; King and McCartney 2007). Consequently, great care is needed in the planning and management of water resources development. In order to maximize benefits and minimize costs, it is essential that decision-making incorporates different stakeholder

perspectives and is based on informed assessments of the trade-offs associated with allocation of water resources between competing needs (McCartney and Awulachew 2006). Multidisciplinary research, comprising objective analyses, is vital to understand complex systems and how development will impact people and ecosystems (Gichuki and McCornick 2008).

As part of its strategy for economic development, as well as contributing to attaining the Millennium Development Goals, the Government of Ethiopia has identified the Lake Tana catchment, located in the headwaters of the Blue Nile (known in Ethiopia as the Abay River) (Figure 1), as a region with high priority for infrastructure

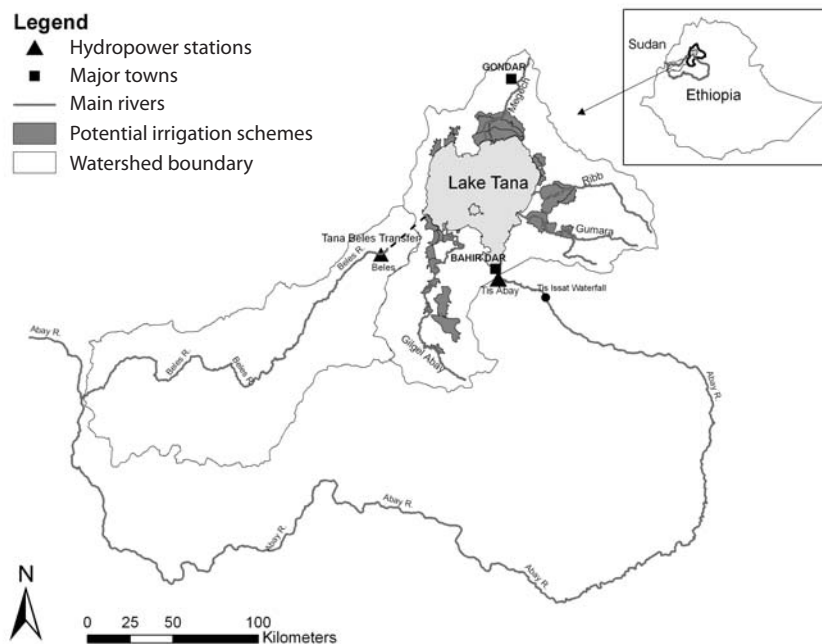

FIGURE 1. Map showing the Lake Tana and Beles River catchments and future irrigation and hydropower development.

investment. This includes the intention to transfer water to the adjacent Beles River catchment and is within the overall context of plans for significant water resources development (i.e., primarily for hydropower and irrigation) throughout the whole of the Blue Nile Basin, both in Ethiopia and Sudan (Awulachew et al. 2008; Block et al. 2007; McCartney et al. 2009).

Lake Tana is important, directly and indirectly, for the livelihoods of many people, but currently the water resources of the catchment are largely unexploited. At present, there is a single dam at the outlet of the lake called the Chara Chara Weir¹. This regulates outflow from the lake for hydropower generation. The intention is, in future, to stimulate economic growth and reduce poverty through the construction of additional infrastructure, specifically hydropower and irrigation schemes (MoFED 2006). To this end, the Tana and adjacent Beles catchments have been identified as one of five “growth corridors” in the country and an integrated water resources development plan is being implemented (World Bank 2008).

This report comprises a synthesis of findings from three component studies conducted to assess

the implications of water resources development in the Lake Tana catchment. These were:

- i) An environmental flow evaluation, conducted to estimate the environmental flow requirements of the Abay River, downstream of the Chara Chara Weir;
- ii) A stakeholder analysis of the Chara Chara Weir conducted to assess the opinions, interests and concerns of various stakeholders, in relation to past water infrastructure development; and
- iii) A modeling study conducted to assess the likely impact of planned future water resources development on lake water levels and the possible implications for local people and other stakeholders.

The next section of this report, *The Study Area*, describes the natural characteristics, current socioeconomic situation and planned water resources development in the catchment. The following sections each describe the research components and the major findings of the study. Finally, there is a discussion of the implications of the findings of the study and conclusions.

The Study Area

Natural Characteristics

Lake Tana is the source of the Blue Nile River. Located at an altitude of 1,786 meters above sea level (masl), the surface area of the lake is 3,156 km². The climate of the area is largely controlled by the movement of the intertropical convergence zone, which results in a single rainy season between June and September. Rainfall is highly correlated with elevation. The mean annual rainfall over the catchment is approximately 1,326 millimeters (mm) (SMEC 2008). Average annual

evaporation over the lake surface is approximately 1,675 mm (SMEC 2008).

The catchment area at the lake outlet is 15,321 km². Since 1996, flow from the lake has been regulated by the Chara Chara Weir. The lake is fed by more than 40 rivers and streams, but 93% of the water comes from four major rivers: Gilgel Abay, Ribb, Gumara and Megech (Figure 1). Mean annual inflow is approximately 4,986 Mm³y⁻¹ (i.e., 158 m³s⁻¹) and the mean annual outflow is approximately 3,753 Mm³y⁻¹ (i.e., 119 m³s⁻¹) (SMEC 2008).

¹ Although called the Chara Chara “Weir”, by international definitions the structure at the outlet of Lake Tana constitutes a large dam since it stores more than 3 million cubic meters (Mm³) of water (ICOLD 2003).

Under natural conditions, prior to the construction of the Chara Chara Weir, discharge from the lake was closely linked to rainfall and there was considerable seasonal and interannual variability. Typically, the lake water level fluctuated between 1,785.75 and 1,786.36 masl (Figure 2). Since the dam became fully operational in 2001 (see section, *The Current Socioeconomic Situation*), the seasonal variation in flows has greatly reduced.

The plains surrounding the lake (i.e., the Dembiya, Fogera and Kunzila plains in the north, east and southwest, respectively) form extensive (1,600 km²) wetlands during the rainy season. As a result of the high heterogeneity in habitats, the lake and surrounding riparian areas support high biodiversity and are listed in the top 250 lake regions of global importance for biodiversity (www.worldlakes.org/lakedetails.asp?lakeid=8568). A quarter of the nearly 65 fish species found in the lake are endemic. The lake contains 18 species of barbus fish (i.e., of the *Cyprinidae* family) and the only extended cyprinid species flock in Africa

(LakeNet 2004). In the area there are at least 217 bird species and the lake is estimated to hold a minimum of 20,000 waterbirds (EWNHS 1996).

The Current Socioeconomic Situation

The total population in the lake basin was estimated to be in excess of 3 million in 2007 (CSA 2003). The largest city on the lakeshore, Bahir Dar, has a population of over 200,000 and at least 15,000 people are believed to live on the 37 islands in the lake (www.worldlakes.org/lakedetails.asp?lakeid=8568). The majority of the population are dependent on rainfed agriculture. Cultivation practices are primitive and crop production and livestock raising are closely integrated. Despite significant potential, there is currently very little irrigated agriculture in the basin. Recent data are hard to come by, but of the estimated 517,500 ha cultivated, traditional small-scale irrigation is practiced on only a small fraction (ca. 500 hectares (ha)). In some places, farmers pump water from the rivers flowing into Lake Tana,

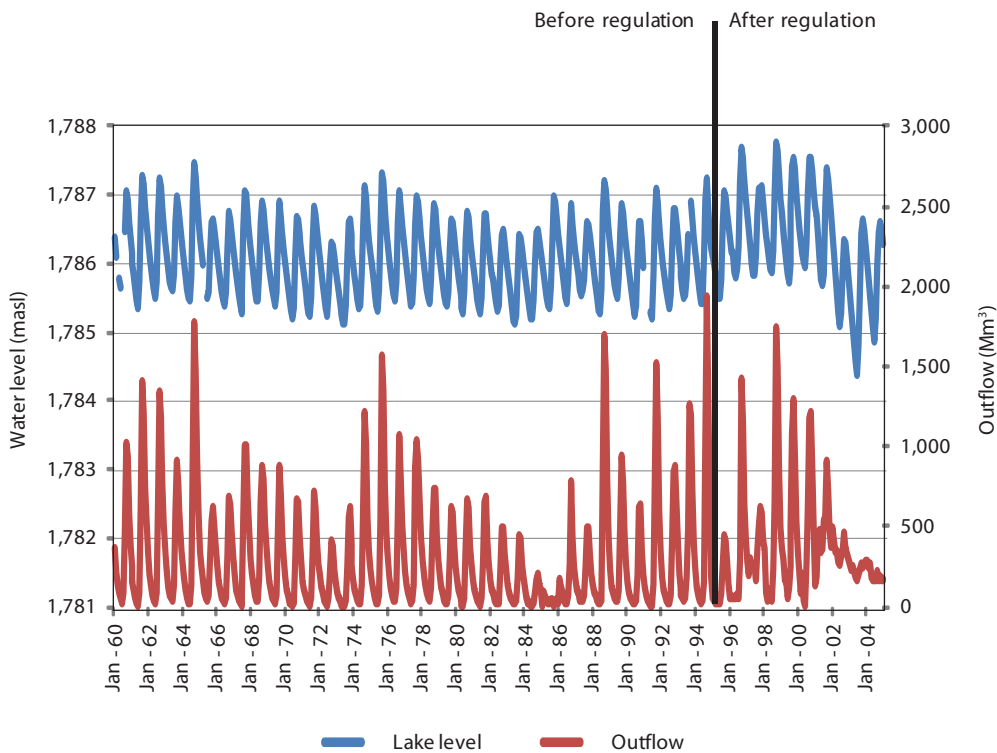

FIGURE 2. Lake level and monthly outflow from Lake Tana (Source: SMEC 2008; MOWR hydrological database).

but the current areal extent of this is unknown. Large-scale irrigation is planned but currently very little has been constructed. Recession cropping, mainly for maize and rice (ca. 6,000 ha), is carried out in the wetlands adjacent to the lakeshore (World Bank 2008).

The potential for wild fish production of Lake Tana is estimated to be 13,000 tonnes per annum, but the current production is only about 1,000 tonnes per year (Berhanu et al. 2001). Many people live on the islands and close to the lakeshore, at locations where there are no roads. Consequently, boat transport is vitally important. For many centuries, the Negede or Weito people, a local ethnic group, have built boats known as 'tanquas' from the papyrus reeds (Gebre et al. 2007). Tanquas are still widely used, but in recent times, some modern fishing boats have been introduced. Ferries also make regular services between the islands.

The Lake Tana region is endowed with many cultural and natural assets. Key amongst these

are approximately 20 monasteries, dating from the sixteenth and seventeenth century, located on the lake islands. Also, the Tis Issat Falls, one of Africa's greatest waterfalls, is located on the Blue Nile approximately 35 kilometers (km) downstream from the Lake Tana outflow. Consequently, the area is an important tourist destination. It is estimated that close to 30,000 people (both domestic and foreign) visit the area each year (EPLAUA 2006).

A hydropower plant was constructed by the Ethiopian Electricity Light and Power Authority (EELPA) at Tis Abay in 1964. Located close to the Tis Issat Falls (Figure 3), the station (Tis Abay-I) was initially used to provide electricity for a textile factory and for domestic supply to the city of Bahir Dar. By diverting water from upstream of the Falls the power plant makes use of the natural 46 m head of the Falls. The installed capacity of the power plant is 11.4 megawatts (MW) and it originally relied entirely on the diversion of the natural flow of the river.

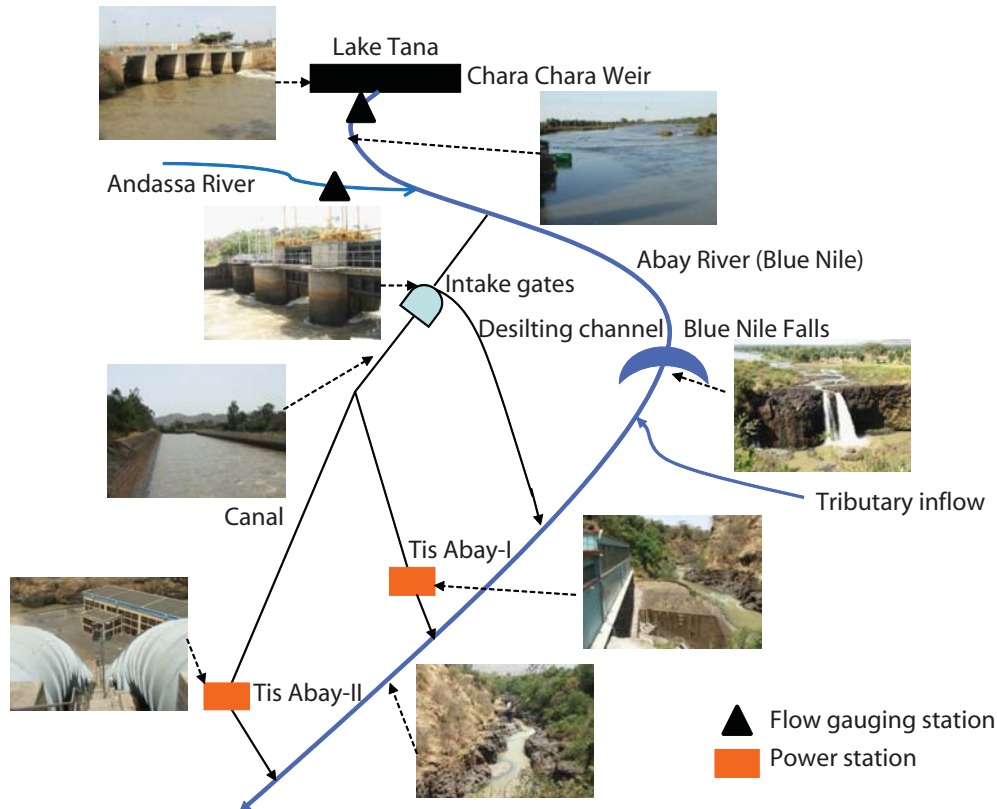

FIGURE 3. Schematic of the Abay River (Blue Nile) downstream of Chara Chara Weir (not to scale).

The concept of building a dam to regulate the outflow from Lake Tana was first suggested in the early years of the twentieth century. However, construction of the dam was not completed until May 1996. Initially, the dam had only two gates, each with a capacity of $70 \text{ m}^3\text{s}^{-1}$, and provided sufficient regulation only to improve the power production from Tis Abay-I. An additional five gates, each also with a capacity of $70 \text{ m}^3\text{s}^{-1}$, were added to the dam in 2001 and a second power station (Tis Abay-II), with an installed capacity of 72 MW, was built 100 m downstream of Tis Abay-I (Figure 3). Since then the dam has been operated by the Ethiopian Electric Power Corporation (EEPCO) (the successor to the EELPA) to maximize electricity production from both power stations. Currently, the two stations represent 10% of the total grid-based electricity generating capacity of the country (814 MW) (www.eepco.gov.et/eepco.htm). Combined, the two power stations generate approximately 440 gigawatt hours (GWh) y^{-1} .

The Chara Chara Weir regulates water storage in Lake Tana over a 3 m range of water levels from 1,784 masl² to 1,787 masl. The active storage of the lake between these levels is $9,100 \text{ Mm}^3$, which represents approximately 2.4 times the average annual outflow. At full supply level, the total flow through the seven gates is $490 \text{ m}^3\text{s}^{-1}$. Approximately $110 \text{ m}^3\text{s}^{-1}$ (i.e., the total flow capacity of both stations Tis Abay-I and Tis Abay-II) can be released continuously with 95% reliability (Bellier et al. 1997).

Regulation for power production has modified the natural lake-level regime, resulting in reduced seasonal but greater interannual variability (Figure 2). The lowest level ever recorded (1,784.4 masl) was in June 2003. This was a drought year in much of Ethiopia and hydropower production was constrained in many places. In an attempt to maintain electricity supplies, production at both Tis Abay power stations was maximized and as a result lake levels dropped sharply. As a consequence of the low lake levels in 2003, navigation ceased for approximately four months (i.e., when lake levels dropped below 1,785 masl, the minimum level at which ships can currently

operate safely), large areas of papyrus reed were destroyed, there was significant encroachment of agriculture on the exposed lake bed and there was a decrease in fisheries production (EPLAUA 2004).

Planned Water Resources Development

As a result of its significant water resources potential, the Lake Tana catchment is at the core of Ethiopia's plans for economic development. A number of schemes are planned for the near future. Currently, the Tana-Beles hydropower project is under construction. This scheme involves the transfer of water from the western side of Lake Tana to the Beles River via a 12 km long, 7.1 m diameter tunnel (Salini and Mid-day 2006). The Beles River is a tributary of the Abay River, with headwaters close to Lake Tana. However, the confluence of the Beles and Abay rivers is approximately 850 km downstream of Lake Tana (Figure 1). As a result, in contrast to the current situation where water diverted for the Tis Abay power stations reenters the river just a short way downstream, water diverted from Lake Tana to the Beles River will be effectively "lost" from the Abay for almost the entire length of the river. Nevertheless, it will flow back into the river just before it crosses the border into Sudan.

The aim of the intra-basin transfer is to generate hydropower by exploiting the 311 m difference in elevation between the lake and the Beles River. A power station, generating a capacity of 460 MW, is being built in the Upper Beles catchment. This will enable far more electricity to be generated than is currently produced by the Tis Abay power stations. The intention is to divert approximately $2,985 \text{ Mm}^3$ through the tunnel (rather than via the Chara Chara Weir) each year to generate 2,310 GWh of electricity (SMEC 2008). After passing through the power station, water will be discharged to the Jehana River, a tributary of the Beles River. Both Tis Abay power stations will be mothballed and only used in emergencies or when lake levels are very high.

² During the construction of the weir, the riverbed at the lake outlet was lowered from 1,785 to 1,784 masl.

In addition, a number of irrigation schemes (ultimately totaling approximately 70,000 ha) are planned on the main rivers flowing into Lake Tana (Table 1).

Of these schemes, only the Koga irrigation

project (6,000 ha) is currently under construction. However, for several of the other schemes detailed feasibility studies have been undertaken and planning is at an advanced stage.

TABLE 1. Planned irrigation development in the Lake Tana catchment (*Source: BCEOM 1998; Mott MacDonald 2004; WWDSE and ICT 2008; WWDSE and TAHAL 2008a, 2008b*).

Irrigation scheme	Irrigable area (ha)	Estimated annual gross water demand (Mm ³) ⁺	Estimated net water demand (Mm ³) ⁺	Large dam storage (Mm ³)	Stage of development
Gilgel Abay B	12,852	104 – 142	88 – 121	563	Feasibility studies ongoing
Gumara A	14,000	115	98	59.7	Feasibility studies completed
Ribb	19,925	172 – 220	146 – 187	233.7	Feasibility studies completed
Megech	7,300	63 – 98	54 – 83	181.9	Feasibility studies completed
Jema ^{**}	7,800	57	48	173	Feasibility studies ongoing
Koga	6,000	62	52	78.5	Under construction
Northeast Lake Tana	5,745	50 – 62	43 – 53	Withdrawals from the lake	Pre-feasibility studies completed
Northwest Lake Tana	6,720	54	46	Withdrawals from the lake	Identification
Southwest Lake Tana	5,132	42	36	Withdrawals from the lake	Identification

Notes: ⁺ Demands estimated through crop water modeling and presented in feasibility study reports. Where a range of demands is presented this reflects alternative cropping patterns. Gross – net demand is water returned to the rivers.

^{**} The scheme was not considered in the current study due to lack of reliable data.

Impacts of the Chara Chara Weir on Lake Tana Outflow and Environmental Flow Assessment

This component of the study comprised an evaluation of the impact of the Chara Chara Weir on outflow from Lake Tana and an estimate of environmental flow requirements in the river reach containing the Tis Issat Falls. These were compared with the actual flows in the river since the dam became fully operational in 2001.

Currently, Ethiopian law (through proclamation number 9/1995 passed in 2002) requires that, for all major development projects, an environmental

impact assessment (EIA) is conducted and that environmental impacts should be minimized. However, there is no specific requirement for environmental flows to be maintained. Although the Chara Chara Weir was constructed prior to proclamation 9/1995, an EIA was conducted. As part of this assessment, an attempt was made to estimate flow requirements over the Tis Issat Falls. However, the focus was on tourist needs and so this evaluation was based primarily on the

appearance of the Falls under different flow regimes (Bellier et al. 1997). The maximum flows were recommended, not for the wet season when flows would naturally be highest, but to make the Falls look most dramatic during the peak tourist season from December to February (Table 2).

More recently, the EIA conducted for the Tana Beles transfer scheme recommended releases from the lake with an annual average of $17 \text{ m}^3\text{s}^{-1}$ (i.e., $536 \text{ Mm}^3\text{y}^{-1}$) and an absolute minimum flow of $10 \text{ m}^3\text{s}^{-1}$ (Salini and Mid-day 2006). Although not based on an ecological study, these flows, in combination with tributary inflows, were deemed adequate to maintain the ecology of both the upper river and the Falls.

Method

In recent years, there has been a rapid proliferation of methods for estimating environmental flows, ranging from relatively simple, low-confidence, desktop approaches, to resource-intensive, high-confidence approaches (Tharme 2003). The comprehensive methods are based on detailed multidisciplinary studies, which often involve expert discussions and the collection of large amounts of geomorphological and ecological data (e.g., King and Louw 1998). Typically, these studies take many months, sometimes years, to complete.

A key constraint to the application of comprehensive methods, particularly in developing countries, is the lack of data linking ecological conditions to specific flows. To compensate for this, several methods of estimating environmental flows have been developed that are based solely on hydrological indices derived from historical data. Although it is recognized that a myriad of factors influence the ecology of aquatic ecosystems (e.g., temperature, water quality and turbidity), the

common supposition of these approaches is that the flow regime is the primary driving force (Richter et al. 1997).

One such method that can be applied is the Desktop Reserve Model (DRM). This is intended to quantify environmental flow requirements when a rapid appraisal is needed and data availability is limited (Hughes and Hannart 2003). It should be viewed only as a preliminary step in deriving environmental flows. Ideally, flow estimates generated by the model should be refined based on far more extensive and detailed ecological and livelihood studies that quantify the links between changing river flows and natural resources, and hence the likely impacts for riparian people.

The DRM is built on the concepts of the building block method, which was developed by South African scientists over several years (King et al. 2000), and is widely recognized as a scientifically legitimate approach to setting environmental flow requirements (Hughes and Hannart 2003). The Building Block Method is developed on the premise that, under natural conditions, different flows play different roles in the ecological functioning of a river. Consequently, to ensure sustainability, it is necessary to retain key elements of natural flow variation. Hence, so called Building Blocks are different components of flow which, when combined, comprise a regime that facilitates the maintenance of the river in a pre-specified condition. The flow "blocks" comprise low discharges as well as high discharges required for channel maintenance. Different estimates are derived for "normal years" and "drought years". The flow requirements in normal years are referred to as "maintenance requirements". The flow requirements in drought years are referred to as "drought requirements" (Hughes 2001). The DRM provides estimates of these building blocks for both maintenance and drought requirements for each month of the year.

TABLE 2. Recommended flow over the Tis Issat Falls from the Chara Chara Weir EIA.

	Jan	Feb	Mar	Apr	May	Jun	Jul	Aug	Sep	Oct	Nov	Dec	Total
Flow (m^3s^{-1})	60	60	10	10	10	10	20	20	40	40	40	60	
Volume (Mm^3)	161	146	27	26	27	26	54	54	104	107	104	161	997

(Source: Bellier et al. 1997)

The DRM has been used extensively in South Africa. Its use in other African countries is limited, but it has been applied in Swaziland, Zimbabwe, Mozambique (Hughes and Hannart 2003) and Tanzania (Kashaigili et al. 2007). The model and similar hydrological approaches have also been used in India and elsewhere in Asia (Jha et al. 2008; Smakhtin et al. 2006). The model comprises empirically derived statistical relationships developed through an analysis of comprehensive environmental flow studies. This found that rivers with more stable flow regimes have relatively higher flow requirements than rivers with more variable flow regimes. This is because in highly variable flow regimes the biota will have adjusted to the relative scarcity of water, whilst in more reliably flowing rivers the biota are more sensitive to reductions in flow (Hughes and Hannart 2003).

Change in Hydrological Regime Caused by the Chara Chara Weir

A gauging station, located immediately downstream of the outlet from Lake Tana (catchment area 15,321 km²), has operated continuously since 1959. The intermediate catchment between the Chara Chara Weir and the diversion to the Tis Abay power stations has an area of 1,094 km². The principal tributary between the lake and Tis Abay is the Andassa River, which is gauged just upstream of its confluence with the Blue Nile (Figure 3). The catchment area at the Andassa River gauging station (which has also operated since 1959) is 573 km².

Time series of monthly flow data from January 1959 to December 2006 were obtained for both gauging stations from the Ministry of Water Resources. Daily flow series from January 1973 to December 2006 were obtained for both stations. An estimate of the contribution from the ungauged portion of catchment downstream of the lake outlet was derived simply by multiplying the flow series derived from the Andassa gauge using an area-weighting. The flows downstream of Lake Tana were added to the flows from the outlet to provide an estimate of the total flow at the diversion to the power stations. Turbine discharge data for both Tis Abay-I and Tis Abay-II power stations were obtained from EEPSCO and used to estimate the monthly flows diverted to produce electricity as well as the water remaining in the river to flow over the Falls.

Analyses of flows were conducted over three time periods: May 1959 to April 1996, May 1996 to December 2000, and January 2001 to December 2006. These periods correspond to different levels of regulation of the Lake Tana outflow (Table 3).

Figure 4 shows the mean monthly flow, measured immediately downstream of the Chara Chara Weir for the three periods investigated. The results from May 1959 to April 1996 indicate the extreme seasonal variability in the natural flow regime, ranging from a mean of 346 m³s⁻¹ in September to just 12 m³s⁻¹ in June. On average, only 12% of the natural discharge from the lake occurred in the five months from February to June. In the period May 1996 to December 2000, both wet and dry season flows were significantly higher than those which occurred during the previous period. The higher dry season flows were a

TABLE 3. Periods of different flow regulation from Lake Tana.

Period	Description
May 1959 - April 1996	No regulation of outflow from Lake Tana. Diversions to the Tis Abay-I power station, directly from the Abay River, commenced in January 1964.
May 1996 – December 2000	Two-gate Chara Chara Weir becomes operational in May 1996. Operated to regulate flow to the Tis-Abay-I power station.
January 2001 – December 2006	Five new gates constructed and become operational in January 2001. Operated to regulate flow to both the Tis Abay-I and Tis Abay-II power stations.

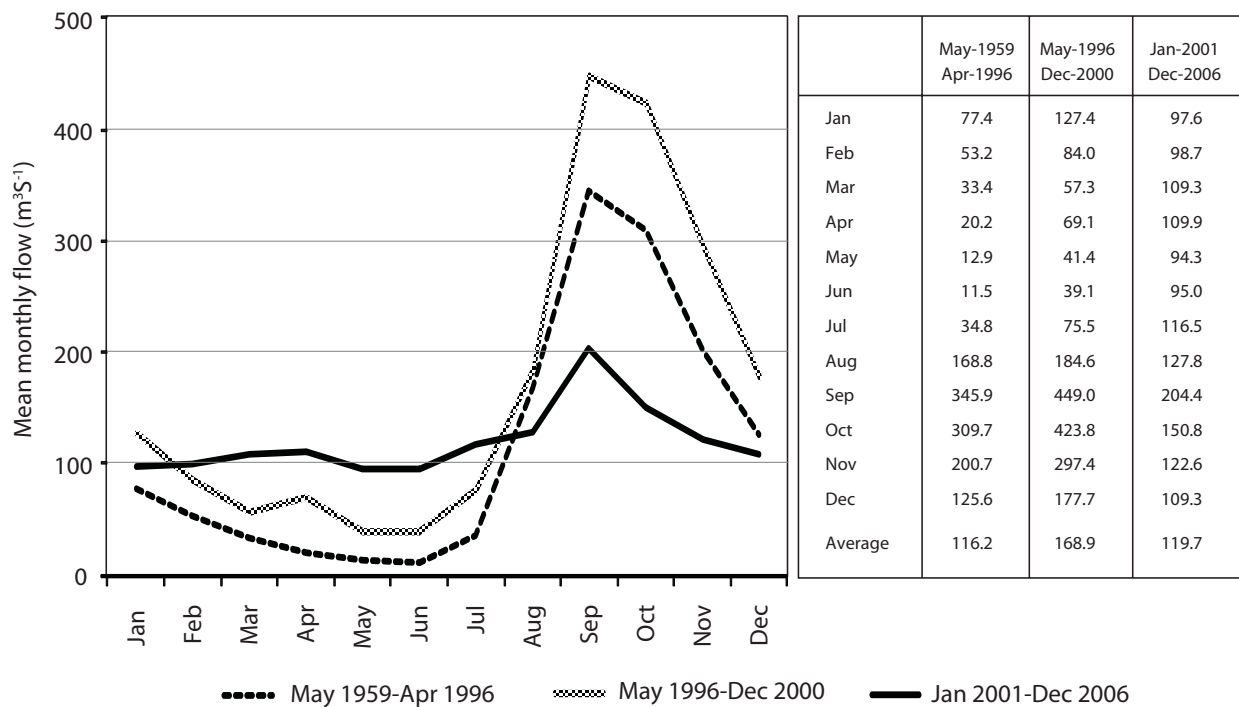

FIGURE 4. Mean monthly flow (m^3s^{-1}) from Lake Tana for three periods of different flow regulation.

consequence of partial flow regulation by the two-gate Chara Chara Weir. The higher wet season flows were a consequence of above average rainfall during these years, particularly in 1998. Mean annual flow in 1998 ($196.0 \text{ m}^3\text{s}^{-1}$; $6,182 \text{ Mm}^3$) was the highest annual discharge measured in the whole 48-year record. The results for the period from January 2001 to December 2006 illustrate the much higher dry season flows and reduced wet season flows arising as a consequence of the full flow regulation by the Chara Chara Weir. As a consequence of regulation, there is much less seasonal variability in flow from the lake. After 2001, 43% of the discharge from the lake occurred in the five months from February to June.

The data provided by the EEPSCO indicate that when only the Tis Abay-I power station was operational (i.e., from 1964-2000) average annual turbine discharge was just 192 Mm^3 (i.e., $6.1 \text{ m}^3\text{s}^{-1}$). Throughout this period just 4.5% of the average

annual discharge at Tis Abay ($4,227 \text{ Mm}^3$) was diverted. Since 2001, when the Tis Abay-II power station came into operation, the average annual turbine discharge has increased to $3,090 \text{ Mm}^3$ (i.e., $97.9 \text{ m}^3\text{s}^{-1}$). This equates to 72% of the average annual discharge at Tis Abay ($4,306 \text{ Mm}^3$) between 2001 and 2006.

Diversions to the original Tis Abay-I power station had very little impact on the flows over the Tis Issat Waterfall. Between 1964 and 2000 average annual discharge over the Falls is estimated to have been $128 \text{ m}^3\text{s}^{-1}$ (i.e., $4,040 \text{ Mm}^3$). By comparison, between 2001 and 2006 the average annual discharge over the Falls is estimated to have been just $41 \text{ m}^3\text{s}^{-1}$ (i.e., $1,305 \text{ Mm}^3$), with a minimum of just $4.7 \text{ m}^3\text{s}^{-1}$ (i.e., 147 Mm^3) in 2004 and less than $12 \text{ m}^3\text{s}^{-1}$ (i.e., 378 Mm^3) in both 2003 and 2005. Between 2001 and 2006, in many months, the mean discharge was less than 50% of what it was prior to 2001 (Figure 5).

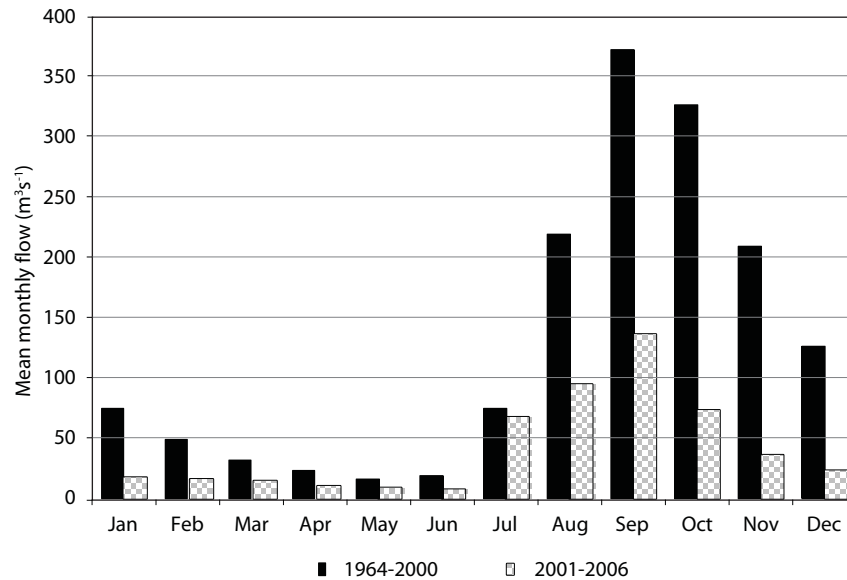

FIGURE 5. Comparison of flow over the Tis Issat Falls for the periods 1964-2000 and 2001-2006.

Estimated Environmental Flow Requirements

The DRM was used to estimate environmental flow requirements in the river reach between the diversion to the Tis Abay power stations and the point where the water currently returns to the river. This reach includes the Tis Issat Falls. To estimate environmental flow requirements, the model needs a naturalized flow series as input. Prior to the construction of the two-gate Chara Chara Weir, outflows from Lake Tana were unmodified and so represent a naturalized flow series. These data were used as input to the model. For the flow over the Falls, the contribution of flow from the Andassa River and the rest of the catchment between Lake Tana and the Falls was added to the Lake Tana outflow series. Some data were missing. Single months of missing data during periods of declining flow were filled by interpolation. However, in cases where there were consecutive months of missing data or where missing data occurred during periods when flows were rising, this was not possible and as a result the entire year was eliminated from the analyses. A total of four months were filled by interpolation and six years were eliminated. Hence, a total of 31 years of data were used as input to the model.

In South Africa, rivers are classified in relation to a desired ecological condition, and flow requirements set accordingly. Six management classes are defined, ranging from A to F. Class A rivers are largely unmodified and natural, and class F rivers are extremely modified and highly degraded (DWA 1999). Classes E and F are deemed ecologically unsustainable, so class D (i.e., largely modified) is the lowest allowed “target” for the future status of a river. This classification system is used in conjunction with the building block method and flow requirements are computed accordingly; the higher the class, the more water is allocated for ecosystem maintenance and the greater the range of flow variability preserved. In the current study, to reflect the importance of water abstractions for hydropower production, the desired ecological condition of the Blue Nile was set as class C/D (i.e., moderately to largely modified). This means that the flow regime will change in such a way that there is likely to be loss and change of natural habitat and biota (possibly including fish) but the basic ecosystem functions of the system will only be moderately altered (Kleynhans 1996). No explicit allowance was made for the aesthetic quality of the flows. However, because the method incorporates the ecological value of higher flows, larger environmental flow requirements are estimated for the months in

which they would occur naturally (i.e., August to December). This is in contrast with the original EIA conducted for the Chara Chara Weir, where tourist “needs” were given primary consideration and the highest flows were recommended at peak tourist times (i.e., December to February) (Bellier et al. 1997). For the more recent Tana-Beles EIA there are no recommendations on the timing of high flows (Salini and Mid-day 2006).

Figure 6 presents a comparison of the observed time series and the environmental flow

series derived from the DRM for the river reach including the Falls. Results from the model indicate that to maintain the river at class C/D requires an average annual environmental flow allocation of 862 Mm³ (i.e., equivalent to 22% of the natural mean annual flow) (Table 4). This is the average annual “maintenance flow” calculated from the sum of both the maintenance low flows (i.e., 626 Mm³) and maintenance high flows (i.e., 236 Mm³). The drought flows correspond to 11% of the mean annual flow (i.e., 440 Mm³).

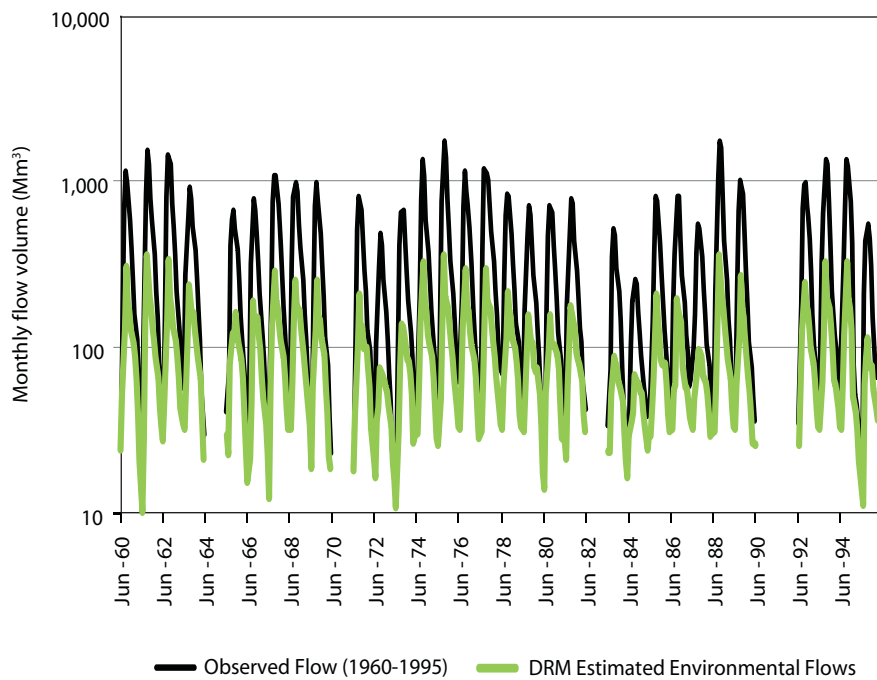

FIGURE 6. Time series of monthly observed flow and estimated environmental flows (1960-1995) for the reach of Abay River that includes the Tis Issat Falls (log scale on the y-axis).

TABLE 4. Summary output from the Desktop Reserve Model applied to the reach of the Tis Issat Falls based on 1960-1995 monthly flow series.

Annual Flows (Mm ³ or index values)							
MAR	=	4,017		Total Environmental flow	=	862 (22% MAR)	
SD	=	1,293		Maintenance Low flow	=	626 (16% MAR)	
CV	=	0.322		Drought Low flow	=	440 (11% MAR)	
BFI	=	0.37		Maintenance High flow	=	236 (6% MAR)	

Month	Observed flow (Mm ³)		Environmental flow requirement (Mm ³)			
	Mean	CV	Maintenance flows			Drought flows
			Low	High	Total	
Jan	217	0.35	68	0	68	48
Feb	135	0.34	56	0	56	39
Mar	97	0.31	42	0	42	30
Apr	58	0.29	28	0	28	20
May	42	0.35	22	0	22	16
Jun	44	0.46	20	1	21	10
Jul	180	0.43	27	11	38	20
Aug	590	0.38	51	33	84	36
Sep	946	0.39	77	115	192	54
Oct	839	0.36	84	33	117	59
Nov	526	0.33	78	31	109	55
Dec	345	0.33	74	12	86	52

Note: MAR – Mean Annual Runoff; SD – Standard deviation; CV – coefficient of variation; BFI – Baseflow Index

For the period 2001 to 2006, average annual flows over the Falls (i.e., 1,306 Mm³) exceeded the total annual maintenance flow requirements predicted by the model (i.e., 862 Mm³). However, a more detailed analysis shows that in most months average flows were significantly less than the environmental flow requirements predicted by the model. For several months average flows were less than 70% of the estimated requirement (Table 5). Only in months July to October (i.e., wet season months) did the average flow over the period 2001 to 2006 exceed the recommendation of the DRM (Table 5; Figure 7). This suggests that, in recent

years, dry season flows have been insufficient to maintain even basic ecological functioning of this reach of the Abay River. Furthermore, even though the average over the period exceeds the DRM recommendation, in several years even the wet season flow was a lot less than recommended. For example, in September and October 2005, flows over the Falls were estimated to have been just 44 Mm³ and 7.6 Mm³ respectively; less than even the recommended minimum drought flows. As well as ecological implications these very low wet season flows significantly impair the visual spectacle of the Falls (Figure 8).

TABLE 5. Comparison of environmental flow requirements computed by the DRM and observed mean monthly flows in the river reach that includes the Tis Issat Falls, between 2001 and 2006.

Month	Total maintenance requirements Mm ³ /month	Observed flows Mm ³ /month	Ratio of observed to environmental flow requirement
Jan	68	44	0.64
Feb	56	36	0.64
Mar	42	36	0.85
Apr	28	22	0.81
May	22	21	0.96
Jun	21	16	0.76
Jul	39	178	4.57
Aug	83	252	3.03
Sep	192	352	1.83
Oct	117	196	1.68
Nov	109	92	0.85
Dec	86	61	0.71
Annual	863	1,306	

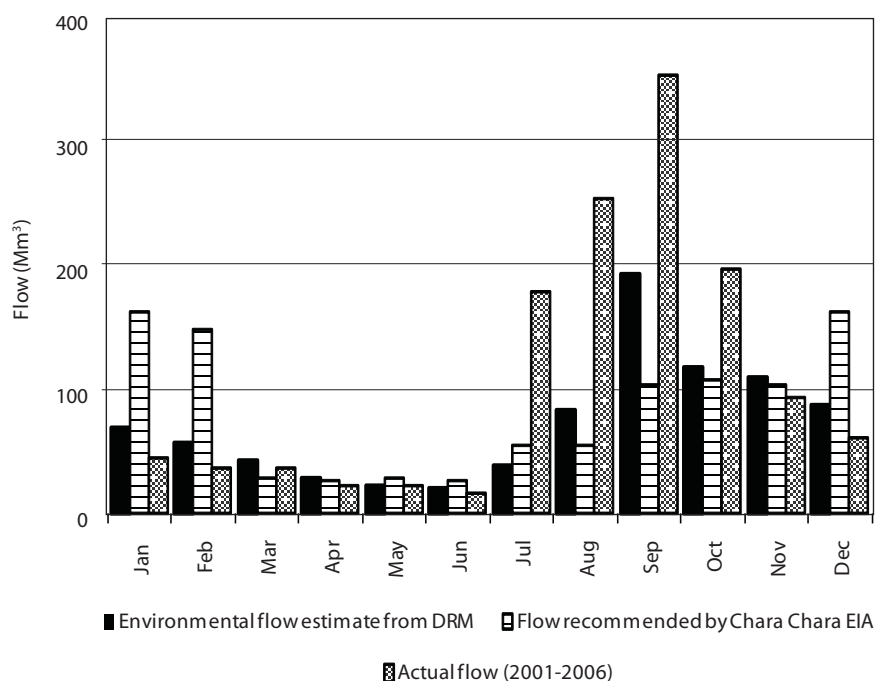

FIGURE 7. Comparison of mean monthly environmental flow requirement estimated using the DRM, with the recommendation of the Chara Chara EIA and the actual flows over the Tis Issat Falls.



FIGURE 8. Photographs to illustrate how the wet season visual spectacle of the Tis Issat Falls have been altered as a consequence of upstream diversions to the Tis Abay hydropower station.

Operation of the Chara Chara Weir has altered the flow regime of the Abay River. Between the outlet from Lake Tana and Tis Abay, the regulation has significantly increased dry season, and significantly decreased wet season, flows. No ecological surveys have been conducted, but studies elsewhere in the world have shown that reduced inter-seasonal variability has an impact on the ecology of the river, benefiting those species that depend on more regular flows whilst adversely impacting those species adapted to seasonal drying (Ward and Stanford 1995). It can also be speculated that the changes in flow are likely to have affected sediment transport and altered water chemistry and temperature regimes. Although the consequences of these changes may not be apparent for many decades, it is possible that, again as has been found elsewhere, they will modify channel

morphology and substrate composition, as well as river biota (Bergkamp et al. 2000).

Since 2001, flows in the reach containing the Falls have been significantly reduced as a consequence of diversions to the power stations. Again, although no ecological surveys have been conducted, there is little doubt that the reduction in flows will have had very severe consequences for many species including aquatic macrophytes, benthic organisms and fish (Staussny 1996). The reduced flows are also very likely to have had adverse impacts on many riparian species. By changing the magnitude and extent of inundation, and altering land-water interaction, the change in flows may have disrupted plant reproduction. Over time it may allow the encroachment of upland plants previously prevented by more frequent flooding (Nilsson et al. 1997).

Stakeholder Analysis of the Chara Chara Weir

The stakeholder analysis of the Chara Chara Weir, conducted between May and July 2007, was undertaken to assess: i) the opinions, interests, and concerns of various stakeholders, in relation to the dam's socioeconomic and environmental impacts; and ii) procedures for decision-making in relation to dam operation. The stakeholders are different community and livelihood groups, as well as a range of relevant government and private organizations. Multiple data gathering instruments, essentially of a qualitative nature (i.e., in-depth (partly structured) interviews with relevant specialists and community leaders, and focus group discussions), were employed to generate information about stakeholder perceptions of the dam, its management and its impact on natural resources and livelihoods. The data gathering was undertaken by a professor and his assistant from the Department of Sociology and Social Anthropology at Addis Ababa University.

Identified stakeholders were divided into primary, secondary and tertiary groups:

- 1) The primary stakeholders are those who are directly affected on a daily basis by operation of the dam. They encompass: i) farmers living upstream of the dam, in close proximity to the shore of the lake, as well as those living close to the river downstream of the dam, between it and the Tis Abay power stations; ii) fishers, comprising both artisanal fishers utilizing reed boats as well as commercial fishers utilizing motorized boats; iii) papyrus boat builders – the Negede; iv) the EEPKO which is responsible for day-to-day operation of the dam; and v) private enterprises with a vested interest in tourism, including hotels and the operators of tour boats.
- 2) The secondary stakeholders are those who directly represent the interests of the primary stakeholders. They include: i) the Lake Tana Transport Enterprise (TTE), responsible for operating the ferries and overseeing navigation on the lake; and ii) the Fishers Cooperative who represent fishers on the lake and promote fisheries development.
- 3) The tertiary stakeholders are regional government departments that make policies and decisions that affect the lake and the livelihoods of people living in its vicinity. Local research institutes, conducting research in the area were also included in this category. They include: i) the Amhara Region Bureau of Water Resources (ARBWR); ii) the Amhara Region Environmental Protection, Land Administration and Use Authority (EPLAUA); iii) the Amhara Parks Development and Protection Authority (PaDPA); iv) the Amhara Region Bureau of Culture and Tourism (ARBCT); v) the Lake Tana Basin Research Centre (LTBRC); and vi) the Amhara Region Agricultural Research Institute (ARARI).

Identified Issues and Concerns

The study identified a range of issues and competing interests between the primary stakeholders, which are leading to conflicts in some instances (Table 6). There is no doubt that through the production of electricity, the Chara Chara Weir and Tis-Abay power stations have contributed significantly to the economy of Ethiopia. However, whilst some local people have gained as a result of the dam, others have lost.

TABLE 6. Summary of issues identified by different stakeholders.

Stakeholders	Issues Identified								
	Reduced lake levels in the dry season	Wet season flooding	Increased dry season flows in Upper Abay	Reduced downstream flooding	Lack of warning of high flows downstream	Reduced flow over the Tis Issat Falls	Loss of vegetation around the lake	Declining lake fish population	Electricity produced
Primary									
EEPCO	NC	NC	NC	NC	NC	-ve	NC	NC	+ ve
Upstream farmers	+ ve	- ve	NC	NC	NC	NC	- ve	NC	NC
Downstream farmers	NC	NC	+ ve	+ ve	-ve	- ve	NC	NC	- ve
Fishers	- ve	NC	NC	NC	NC	NC	- ve	- ve	NC
Negede	- ve	NC	NC	NC	NC	NC	- ve	- ve	NC
Hotel owners	- ve	- ve	NC	NC	NC	- ve	NC	- ve	+ ve
Tour boat operators	- ve	NC	NC	NC	NC	NC	NC	NC	NC
Secondary									
Tana Transport Enterprise	- ve	NC	NC	NC	NC	NC	NC	NC	NC
Fishers Cooperative	- ve	NC	NC	NC	NC	NC	- ve	- ve	NC
Tertiary									
Amhara Culture and Tourism Bureau	- ve	- ve	NC	NC	NC	NC	NC	NC	+ ve
Amhara Region Bureau of Water Resources	NC	- ve	NC	NC	NC	NC	NC	NC	+ ve
Amhara Region Environmental Protection, Land Administration and Use Authority	- ve	NC	NC	NC	NC	- ve	- ve	- ve	NC
Amhara Parks Development and Protection Authority	- ve	NC	NC	NC	NC	NC	- ve	- ve	NC
Lake Tana Basin Research Centre	- ve	NC	NC	NC	NC	- ve	- ve	- ve	NC
Amhara Region Agriculture Research Institute	- ve	NC	NC	NC	NC	- ve	- ve	- ve	NC

Notes: +ve = positive impact; -ve = negative impact; NC = not an expressed concern

The EEPCO noted the importance of the Tis Abay power plants for electricity generation in Ethiopia and see the power production as both a regional and national benefit. The company spokesman highlighted the Universal Electrification Access Programme which aims to increase access to electricity from 15 to 50% of the population over the five years from 2005 to 2010. Between 2005 and 2007, the EEPCO claims to have increased access to 22% with an additional 758 towns and villages electrified in 2007. The company recognizes that the diversion to the power stations is adversely affecting the visual

spectacle of the Tis Issat Falls. However, the spokesman emphasized the fact that the shift to electricity lessens environmental degradation by reducing biomass fuel requirements. The company, therefore, believes that the power stations have overall resulted in a net environmental benefit. It was acknowledged that the cost of electrical appliances, in particular stoves and cookers, limits uptake by poor rural households.

Farmers living both upstream and downstream of the dam have broadly benefited from it. In upstream locations, increased drawdown of the lake has resulted in increased exposure of the lake bed

and encouraged the practice of dry season recession agriculture. In 2003, the lake was drawn down to its lowest recorded level, farmers extended crop production onto about 562 ha of the lake bed, utilizing the moist nutrient-rich silt deposits for both horticultural and cereal crops (EPLAUA 2004). Downstream of the dam, farmers have benefited from reduced wet season flooding and, because of the guaranteed flows and consequent access to water in the dry season, have expanded small-scale irrigation schemes. Women, who collect water from the river for drinking and household use, have benefitted as a consequence of easier access in the dry season. One farmer downstream of the dam stated:

The weir has not caused us harm in any way. In fact, we are getting a greater supply of water in the dry season because of it.

Other people have been adversely affected by the dam. Many of those living in the small community of Tis Abay, adjacent to the power stations and very close to the Tis Issat waterfall complained that they have been negatively impacted. Surprisingly, the number of tourists visiting the Falls has increased in recent years (Shiferaw 2007). This is partly the result of greater numbers of tourists generally in Ethiopia and partly because the Falls are still promoted as a major tourist attraction. Many of the tourists who visit Bahir Dar are unaware that flows over the Falls have decreased. However, according to local people, many visitors are now unhappy with the visual spectacle³ and, because they are annoyed, refuse to buy locally-made handicrafts. In the past, the selling of these products contributed significantly to the income of many local people. Although a few people have gained employment at the power stations many have not. The loss of income from tourists has had a negative impact on the livelihoods of many local people which have not been compensated through alternative opportunities. The local community also complains

that they have no access to electricity, despite the fact that the power stations are located very close to their village. Furthermore, development opportunities (e.g., a school and health center) promised when the Tis Abay-II power station was built, have not been forthcoming. One local elder stated:

We have not benefited in any way from the power plant. This is despite constant appeals to the concerned regional authorities, filing petitions a number of times and pursuing the case over a long period [of time]. Four hundred households were promised electric power supply by [the] EEPCO and [were] required to pay registration fees for that purpose. However, it has not so far materialized and the area still remains without access to electricity.

A significant number of people are dependent on fishing from Lake Tana for their livelihoods. The development of the commercial fishery, using motorized boats, was initiated by an EU-sponsored Lake Fisheries Development Program in 1986. The establishment of the Fishers Cooperative in December 1994 has added impetus to the development of the sector. The current membership of this cooperative is 150 fishers, of whom 134 are men and 16 women. Fishers complain that since the dam was constructed, dry season drawdown of the lake has increased and resulted in desiccation of reed beds and consequent loss of fish breeding habitat. This has been exacerbated by farmers clearing reeds to create fields. Extreme drawdown of the lake in 2003 made navigation difficult and resulted in the sinking of some boats when they hit submerged rocks. One fisher stated:

The shrinking of the lake dried out plant species vital for the reproduction of fish stocks, resulting in [a] large loss of many fish varieties. That was not the only dire consequence. The further the lake retreated, the larger the area of

³ This perception was validated by hotel managers who confirmed that tourists complained to them that the Falls are no longer as described in tourist books, brochures and publicity material.

lakeshore that turned into dry ground where fishers could no longer cast their nets. The fish have also moved further in toward the deeper parts of the lake which makes catching them more difficult.

The Negede people have been particularly hard hit. They rely on papyrus reeds for much of their livelihood; using it to construct canoes for lake traders and other people who move around the lake by boat. They also use the reeds to make household utensils (such as baskets and mats) which they sell in local markets, both for utilitarian purposes and as tourist souvenirs. In addition, they cut and sell papyrus trunks to urban people for fence making. Since the construction of the dam, they complain that many of the papyrus beds have dried out and large areas have died. As with the fishers, they also complain that farmers have burnt and cleared reeds to cultivate crops. A Negede spokesperson stated:

We are extremely worried in relation to the Chara Chara Weir. If Lake Tana continues to shrink as the weir drains its water the likely scenario is that our livelihood will be destroyed, and together with it our future. Conflict with farming groups who cultivate the wetlands is unavoidable....

Many people living in the vicinity of the lake use boat transport on an almost daily basis to attend school, visit health facilities and travel to and from markets. For example, many of the 10,000 inhabitants of Dek Island (the largest lake island) are dependent on growing mangoes and on boats to get these to markets. Tourists also use boats to travel to many of the islands to visit the monasteries. The head of the TTE stated that navigation on the lake is seriously compromised when water levels drop below 1,785 masl. When this happened in 2003, the cost arising because of service interruption and damage to boats is estimated to have been about 4 million Ethiopian Birr (i.e., approximately US\$400,000) (Alemayehu 2008).

The government departments had differing views on the dam and its operation. The ARBWR took the view that the socioeconomic benefits

arising from the electricity produced significantly outweighed any costs. In contrast, staff at the EPLAUA expressed concerns over the environmental impacts of the dam and its operation and the associated impacts on the Negede, fishers and communities dependent on tourism. Staff at the PaDPA argued that the historic and cultural value of the lake, as well as the river corridor to the Tis Issat Falls, meant that the region should be designated as a protected area with much greater recognition of its heritage value in current management and future development planning.

Decision-Making Process

A common view, expressed by many stakeholders and implicitly recognized by the EEPSCO and government departments, was that the decision-making processes in relation to both the planning and operation of the dam were not ideal. There is little doubt that the general lack of stakeholder consultation has fuelled controversies and resulted in widespread rumors and speculation about the function of the dam and its resultant impacts. Both the TTE and the Fishers Cooperative complained that the interests of the stakeholders they represent were totally ignored in the planning of the dam. This has been exacerbated by the lack of transparency and participation in decision making related to the way the dam is now operated. Both organizations feel that the EEPSCO's sole consideration is electricity generation and other stakeholder needs are simply ignored. The director of the LTBRC complained that they experience difficulties in obtaining data and information which help to make informed assessments of the benefits and costs of the dam and its operation.

A similar lack of transparency has been a feature of decision-making in other development projects in Ethiopia. A study of the follow-up of the EIA conducted for the Koga irrigation scheme found that almost nonexistent public participation in decision-making was a major constraint to implementation of EIA recommendations (Abebe et al. 2008). Similarly, with the Tana-Beles scheme, there has been little public consultation. Even

though it will most likely be commissioned this year, there is no general understanding of how it will be operated. Although, it was not a primary focus of the research conducted, this study found that many stakeholders hope that, overall, the scheme will be beneficial for both the lake and themselves. However, there is little understanding of the likely impacts of the scheme. Many

stakeholders simply believe that with the closing of the Tis Abay power stations, all the problems will be resolved and the lake and downstream flows will revert to a natural cycle. The fact that the water transfer to the Beles River, in conjunction with the planned irrigation schemes, is likely to increase pressure on the lake and require very careful management is not widely appreciated.

Simulation of Future Water Resources Development

In this component of the study, the Water Evaluation And Planning (WEAP) model was used to investigate scenarios of future water resources development in the Lake Tana catchment. The model was used to investigate both the reliability of water availability for the planned schemes and their impact on lake water levels and lake surface area. The implications of water-level fluctuations on lake navigation were assessed. The implications of maintaining environmental flows downstream of the lake to the Tis Issat Falls were also ascertained.

Configuration of the WEAP Model to the Lake Tana Catchment

The WEAP model was developed by the Stockholm Environment Institute (SEI) in Boston and provides an integrated approach to simulating water systems associated with development (Yates et al. 2005). The WEAP model represents the system in terms of its various supply sources (e.g., rivers, inter-basin transfers and reservoirs); withdrawals, transmission and wastewater treatment facilities; ecosystem requirements, and water demands (i.e., typically comprising hydropower, irrigation, domestic supply, etc.). The model essentially

performs a mass balance of flow sequentially down a river system, making allowance for abstractions and inflows. The model optimizes water use in the catchment using an iterative Linear Programming algorithm, the objective of which is to maximize the water delivered to demand sites, according to a set of user-defined priorities (SEI 2007).

The modeling of the Lake Tana catchment encompassed the major tributaries to the lake, upstream of the proposed dams (i.e., water that currently flows directly into the lake that will in future be affected by regulation from the dams), estimates of flows downstream of the proposed dams and total inflows on other rivers (i.e., flows that will be unaffected by future development) and Lake Tana (Figure 9). Lake Tana was simulated as a reservoir. The Andassa River was also included. The model was configured to run on a monthly time step.

As primary input to the WEAP model, the inflow series at the planned dam sites were obtained from the relevant feasibility studies for the period 1960-2004. Where necessary inflow data were augmented using area-weighted estimates from the nearest available flow gauging station. To simulate the current situation, the Tis Abay hydropower plants were included as a demand node on the Abay River, downstream of the lake.

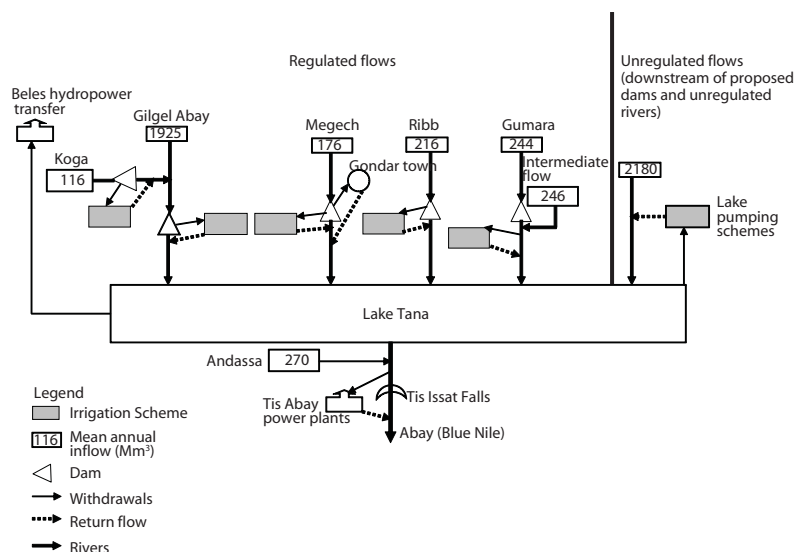

FIGURE 9. Schematic of existing and planned water demand in the Lake Tana catchment as simulated in the WEAP model, showing the mean annual flow upstream of the proposed irrigation dams as well as unregulated flows into the lake.

The model was calibrated by trial and error. Calibration was undertaken by comparing the simulated and observed lake water levels and the flow from the lake. The final selection of model parameters was based on both quantitative objective functions (e.g., the Nash coefficient), and qualitative assessment of the goodness of fit, based on simple comparison of observed and simulated water-levels and flows over the period 1960-2004. The parameters modified were those that altered the natural flow from the lake and operation of the Chara Chara Weir after 1995. With the selected parameters, for the flow the percentage error in the mean annual value was 9.0% and the Nash coefficient was 0.57. For the lake water level, error in the mean annual value was <1% and the Nash coefficient was 0.74. These values indicate that the model performance was reasonable.

Description of Development Scenarios

Data for the various scenarios used in this study were obtained from the Abay River Basin Integrated Development Mater Plan and the feasibility studies conducted for each of the proposed schemes

(BCEOM 1998; Mott MacDonald 2004; WWDSE and ICT 2008; WWDSE and TAHAL 2008a, 2008b). These indicate how the water demand for both irrigation and hydropower is likely to change in the catchment in the future.

Four scenarios were developed based on the current stage of scheme development and hence the likelihood of full implementation (Table 7). Each development scenario was run for the 36 years (i.e., 1960-1995). This period was selected, both because data are available and because it represents a wide range of hydrological variability. Furthermore, it represents years before construction of the Chara Chara Weir and so the impact of each development scenario could be compared with the natural water-level regime of the lake.

In all cases, irrigation demand was computed based on assumptions about cropping patterns (i.e., encompassing crop type and percentage of command are utilized) and crop water requirements. In the feasibility studies, the FAO CROPWAT program (Allen et al. 1998) was used to determine total irrigation requirement. In some cases, alternative cropping patterns were simulated, but for the results presented here, the pattern that created the highest demand was selected for all schemes. In all cases, allowances

TABLE 7. Summary of development scenarios (Source: BCEOM 1998; EEPKO database; and SMEC 2008).

Scenario	Hydropower developed	Irrigation schemes developed	Total mean annual water demand (Mm ³) ^a
Baseline Scenario (BS)	Tis Abay I and II	-	3,469
Ongoing Development Scenario (ODS)	Tana Beles transfer	Koga	3,047
Likely Development Scenario (LDS)	Tana Beles transfer	Koga, Megech, Ribb, Gumara and Gilgel Abay	3,621
Full Development Scenario (FDS)	Tana Beles transfer	Koga, Megech, Ribb, Gumara, Gilgel Abay and 3 schemes pumping directly from the lake	3,768

Note: ^awater demand has been calculated using the highest crop water estimates for each of the irrigation schemes.

were made for transmission losses from canals. Return flows were estimated as 15% of the water diverted.

For the proposed new dams no operating rule curves are currently available. Consequently, no operating rules were incorporated within the WEAP model. This meant that the reservoirs were not drawn down to attenuate wet season floods and no restrictions were applied on abstractions as the reservoirs emptied. The one exception was Lake Tana, where the operating rule was derived from the pattern of operation in recent years. Thus, restrictions on drawdown were applied to reduce abstractions as lake levels dropped below 1,786 masl and to ensure levels did not drop lower than the minimum operating level of 1,784 masl. Net evaporation (i.e., evaporation minus rainfall) was computed from rainfall and evaporation data obtained from the meteorological station located closest to each reservoir.

Since it provides the highest economic returns, electricity generation was designated a higher priority than irrigation. The water demand for domestic, municipal and industrial uses were not considered. This is because their impact on water resources of the lake, both now and in the near future, is insignificant (SMEC 2008).

Each scenario was run with the flow requirement for the Tis Issat Falls as recommended in the most recent EIA conducted for the Tana-Beles transfer scheme. These flows were termed the Tana Beles Flow (TBF) requirements⁴. The scenarios were then repeated with the time series of environmental flow requirements estimated in the current study using the DRM (see section, *Estimated Environmental Flow Requirements*). These flows were termed the Variable Environmental Flow (VEF) requirements. In both cases, the proposed minimum instream flows downstream of each of the proposed irrigation dams (as identified in the feasibility studies and in all cases simply a minimum baseflow) were also included. In all cases, environmental flows were given higher priority than hydropower production.

Analyses of Output from the WEAP Model

For each scenario, the WEAP model was used to predict: i) the impacts on lake water levels and lake area for each month of the 36 years simulated; and ii) unmet demand for hydropower and irrigation in any month. In each scenario, the time series of

⁴ For the baseline scenario, flows released from the lake to provide water for the power station exceed the TBF environmental flow requirements. However, most of the water is diverted to the Tis Abay hydropower stations. To ensure a TBF over the Falls, for the baseline scenario the location of the TBF requirement was moved from immediately below the dam to the location of the waterfall.

lake water levels was analyzed to determine the number of months where the mean water level was less than 1,785 masl (i.e., the minimum required for shipping) over the 36 years of simulation.

For unmet demand, the data were summed to calculate the annual unmet demand for each of the 36 years of simulation. Since the frequency of occurrence of unmet demand is of more interest to planners than the mean annual unmet demand, standard frequency analyses were conducted to determine the return periods for different magnitudes of shortfall. This involved fitting a statistical distribution (i.e. a two-parameter log-normal equation) to each time series of annual unmet demand. The results were then converted to assurance levels (i.e., volumes of water that can be guaranteed with different degrees of certainty). For each return period estimated, this was done by subtracting the shortfall from the demand (i.e., to give the volume that could be guaranteed) and converting the return period to a level of assurance. For example, return periods of two, five and 100 years correspond to assurance levels of 50, 80, and 99%, respectively. For hydropower, the volumes of unmet water demand were converted to shortfalls in electricity produced, so that assured levels of electricity generation (i.e., GWh^{-1}) could be computed.

There is always some uncertainty associated with fitting statistical distributions. In this study this was particularly the case for those series in which failure to meet demand occurred in only a few years of the 36-year series. Consequently, the assurance levels are not precise, but in each case are indicative of the probability of satisfying demand in any year.

Simulation Results

Figure 10 presents a comparison of the time series of simulated lake levels for all scenarios with the natural condition, both with the downstream TBF

and the VEF included. Table 8 summarizes the results of each scenario. The results indicate the decline in mean annual lake levels, and consequently lake area, as water resources development in the catchment increases.

As would be expected, the greatest impact of the water resources development occurs during dry cycles, in particular, from years 8 to 14 and, most significantly, from years 20 to 29 of the simulation. During these periods, even without VEF releases, lake water levels are, depending on the development scenario, up to 0.82 and 1.76 m lower than natural levels in the dry and wet season, respectively (Figure 10).

As water resources development increases there are longer periods of time when mean monthly lake levels are below 1,785 masl (Table 8). Under natural conditions lake levels never dropped below this level. Under current conditions (BS), they exceed this level in 88% of the months. In the ODS, this will increase to 90%. The improvement occurs because the total demand of the Beles power station and Koga irrigation scheme (i.e., $3,047 \text{ Mm}^3\text{y}^{-1}$) is slightly less than current demand of the Tis Abay power stations (i.e., $3,469 \text{ Mm}^3\text{y}^{-1}$). However, when the additional irrigation schemes become operational, lake water levels will decline. In the FDS, even without the VEF releases, water levels exceed 1,785 masl just 78% of the time (Table 8). In some drier years (i.e., years 20 to 28) they hardly exceed this level in any month (Figure 10d).

In comparison to the TBF, the VEF requirements, because they necessitate more water flowing over the Falls, exacerbate the drop in lake water levels in all scenarios. In the current situation (BS), the VEF would result in water levels being above 1,785 masl just 75% of the time (c.f. 88% with TBF). In the FDS with VEF, water level exceeds 1,785 masl just 60% of the time and the mean lake area is reduced from 3,080 to 3,023 km^2 (Table 8).

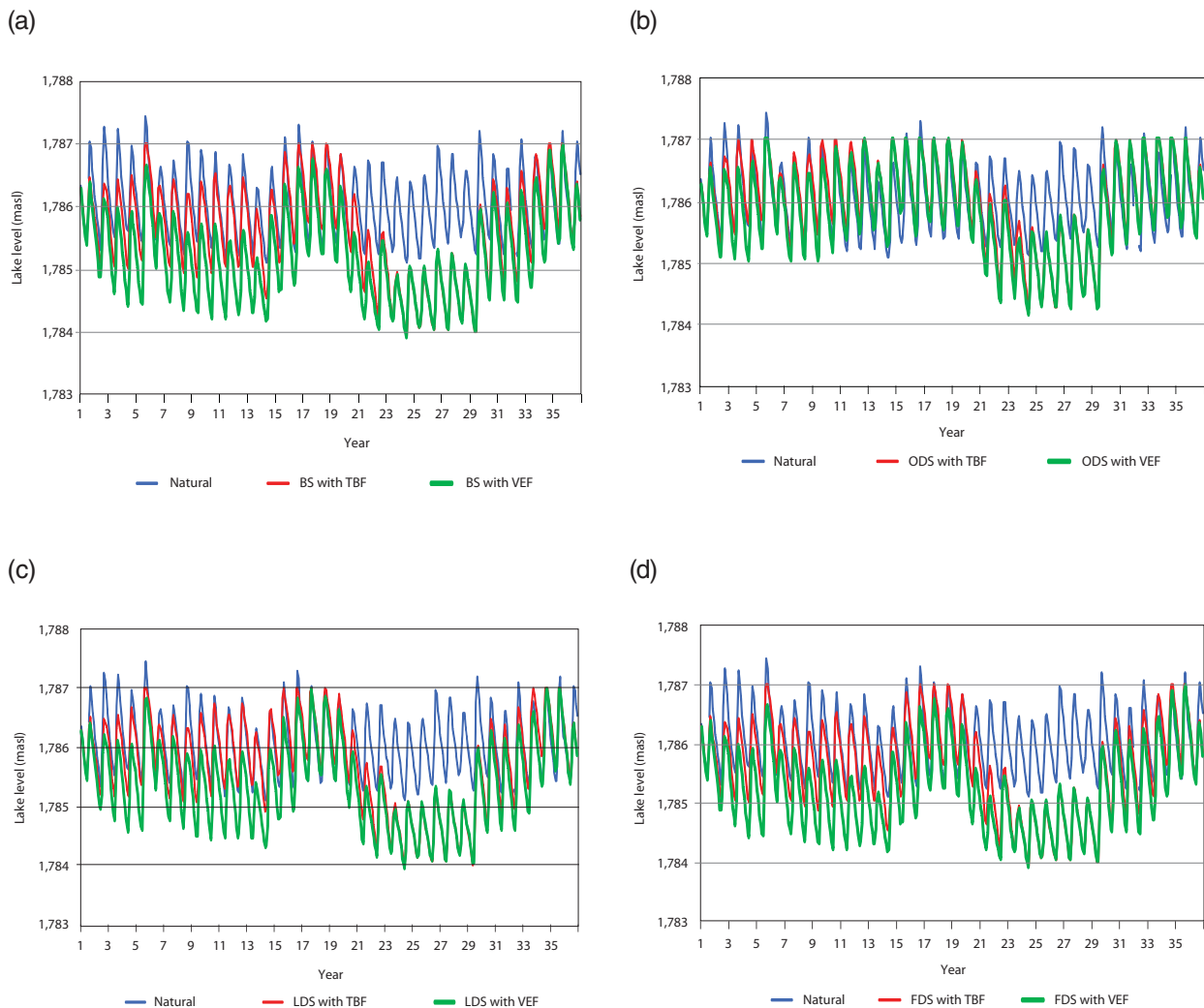

FIGURE 10. Comparison of simulated and natural (observed) lake levels over 36 years with the TBF and the VEF for each scenario. Scenarios are: a) BS, b) ODS, c) LDS, and d) FDS.

Table 9 presents the estimates of irrigation water that can be supplied at different levels of assurance in each of the scenarios. The results indicate that, as would be expected, as the level of water resources development increases (i.e., there are more dams built) the amount of water that can be supplied for irrigation at low assurance levels increases. The results also indicate that, again, as would be expected, less water can be delivered at higher levels of assurance. This simply means that, in years of lower rainfall and hence lower flow in the rivers, less water is available for irrigation. The results show that in years of very severe drought (e.g.,

approximately once in a 100 years) almost no water would be available for irrigation. Between the LDS and FDS, the increase in irrigated area results in a decrease in the amount of water that can be supplied at high levels of assurance. The results also show the degree to which, in all scenarios, implementation of the VEF reduces water availability for irrigation (i.e. from 1% to 68%). The VEF has a greater impact, both at higher levels of assurance and higher levels of development.

Table 10 presents the estimates of electricity that can be generated with different levels of assurance in each of the scenarios. These

TABLE 8. Summary of simulation results for each scenario with minimum maintenance flow and variable environmental flows.

Scenario	TBF					VEF				
	Mean water levels (masl)	Mean lake area (km ²)	Mean power generated GW ^{hy} - ¹	Mean irrigation water supplied Mm ³ y ⁻¹	% time that mean water level exceeds 1,785 masl ⁺	Mean water levels (masl)	Mean lake area (km ²)	Mean power generated GW ^{hy} - ¹	Mean irrigation water supplied Mm ³ y ⁻¹	% time mean water level exceeds 1,785 masl
Natural	1,786.1	3,080	16*	0	100	1,786.1	3,080	16*	0	100
BS	1,785.9	3,070	445	0	88	1,785.6	3,045	333	0	75
ODS	1,786.0	3,077	2,247	55	90	1,785.9	3,067	2,225	54	89
LDS	1,785.7	3,057	2,207	548	81	1,785.4	3,034	2,178	537	66
FDS	1,785.6	3,049	2,198	677	78	1,785.2	3,023	2,134	644	60

Note: ⁺1,785 masl is the minimum level required for shipping

* hydropower produced by Tis Abay-I power station by diverting unregulated flow

estimates confirm that far more electricity is generated through implementation of the Tana Beles transfer than is currently produced from the Tis Abay power stations. The results show that in the ODS with the TBF, 1,903 GWhy⁻¹ can be generated with 99% assurance (i.e., less would be generated on average only once every 100 years). This compares to a firm energy

estimate of 1,866 GWhy⁻¹ (Salini and Mid-day 2006). Firm energy is normally defined as that which can be guaranteed at an assurance level of 99.5%. Hence, this indicates that the results from the WEAP model are comparable with those derived in the system design and so add to the confidence that the WEAP model simulation is reasonable.

TABLE 9. Comparison of scenarios: irrigation water that can be supplied at different levels of assurance (Mm³).

Assurance level (%)	BS		ODS		LDS		FDS	
	TBF	VEF	TBF	VEF	TBF	VEF	TBF	VEF
50	-	-	59	58	561	540	687	645
80	-	-	54	52	475	440	575	510
90	-	-	47	44	397	353	471	391
96	-	-	34	29	272	217	296	208
98	-	-	20	14	159	96	147	47
99	-	-	1	-	26	-	-	-

TABLE 10. Comparison of scenarios: electricity that can be generated at different levels of assurance (GWhy⁻¹).

Assurance level (%)	BS		ODS		LDS		FDS	
	TBF	VEF	TBF	VEF	TBF	VEF	TBF	VEF
50	439	392	2,154	2,138	2,088	2,043	2,108	2,111
80	426	340	2,089	2,040	1,996	1,954	2,009	1,992
90	417	299	2,045	1,967	1,937	1,896	1,938	1,904
96	404	239	1,989	1,869	1,861	1,824	1,845	1,784
98	394	189	1,946	1,791	1,805	1,771	1,773	1,687
99	384	135	1,903	1,709	1,748	1,718	1,698	1,659

Table 10 shows that as irrigation in the Lake Tana Basin increases, even though electricity generation is given the higher priority, the reliability of generation declines. Thus, in the LDS and the FDS, electricity generation at the 99% assurance level decreases to 1,748 GWhy⁻¹ and 1,698 GWhy⁻¹, respectively, under the TBF requirement. This is the consequence of reduced

inflows to Lake Tana as a result of the increased irrigation. The results also show the degree to which implementation of the VEF further reduces the reliability of electricity generation in all scenarios. As with irrigation, the VEF has a greater impact on electricity generation, both at higher levels of assurance and at greater levels of development.

Discussion

Current Situation

By contributing to a significant proportion of the country's electricity, the Chara Chara Weir has contributed to the development of Ethiopia and brought significant benefits to many people. However, the construction of the Chara Chara Weir and its operation has also had an impact on the natural and social landscape of the Lake Tana catchment and upper reaches of the Abay River. The changes caused by the dam have affected the customary and *de facto* entitlements to natural resources, environmental quality and sociocultural integrity experienced by communities living both upstream and downstream of the dam. Whilst some people have gained the dam has brought hardship to others. To date, the needs of those adversely affected have, for the most part, been inadequately considered in decision-making processes.

The operation of the Chara Chara Weir has increased interannual variability in lake levels. Increased drawdown in the dry season, most significantly in 2003, resulted in the desiccation of many areas that were permanently inundated previously. This has caused the loss of aquatic vegetation, including most significantly papyrus reeds, on which the Negede people depend. Although this has not been scientifically confirmed, this may have also contributed to a decline in fisheries, since the reeds provide both breeding habitat and *refugia* for fish. In 2003, the disruption to shipping, as a result of the reduced water levels, had significant economic and social implications for many of the people who live on the islands and around the lakeshore.

Although there have been no detailed ecological studies, the reduction in flows in the reach containing the Tis Issat Falls will most likely have had adverse ecological impacts. Although the average annual total flow over the falls exceeds the DRM estimated flow requirement, the flow during many months is considerably lower than the minimum estimated requirement. In this study, by selecting a C/D

management classification for the reach, the importance of electricity for the socioeconomic development of the country is recognized. A C/D classification recognizes that, in the interests of Ethiopia's development, it is necessary to modify the river from its natural condition. However, for reasons of equity and sustainability, it is still necessary to maintain the basic ecosystem functions of the river. If flows are changed too much, the lotic system will be modified completely with major loss of natural habitat and the destruction of basic ecosystem functions. This could have long-term consequences, not only for biota but also for people living in the area. It is, therefore, necessary to derive an adequate compromise between the ecological characteristics of the river and the level of direct human utilization. The current planning for future development should provide the opportunity to consider how the basic ecosystem functions of the river can be safeguarded, even if this means foregoing some electricity and irrigation.

The accuracy of the results from the DRM cannot be substantiated without further study. Given that it is underpinned by empirical equations, developed specifically for South Africa, and is only intended to be a "low-confidence" approach, the results must be treated with caution. However, in the absence of quantitative information on the relationships between flow and the ecological functioning of the river ecosystem, it provides a valuable estimate of environmental flow requirements in the upper reach of the river. To improve the environmental flow estimates, detailed studies need to be undertaken to investigate the ecological sensitivity of the river to flow modification throughout its length - from the Lake Tana outlet to the Falls and, indeed, downstream from this point onwards.

Future Development

The analyses conducted in this study quantify some of the possible impacts arising from future

water resources development in the catchment. In the past, the water level of the lake was affected primarily by variation in rainfall (Kebede et al. 2006). Results of the simulations indicate that anthropogenic activities are the major control now and increasingly will be in the future.

If the full development scenario in the Lake Tana catchment is implemented, approximately $3,600 \text{ Mm}^3\text{y}^{-1}$ of water will be diverted for hydropower and irrigation schemes. As a result, the mean annual water level will be lowered by 0.44 m and there will be prolonged periods of several years, during which water levels will be much lower than they would be naturally. Furthermore, the average surface area of the lake will decrease by 30 km^2 (i.e., 3,000 ha). In some years, this will be reduced by as much as 81 km^2 (81,000 ha) during the dry season. This is likely to have significant impacts on the ecology of the lake, particularly in the littoral zone and in the wetlands around the shore.

The experience of 2003, when farmers extended crop production onto the lake bed, indicates that lower water levels will almost certainly result in people moving both cultivation and grazing onto the dried lake bed. This would exacerbate adverse impacts on near-shore vegetation and could increase sedimentation in the lake. Moreover, during periods of several years of drawdown (as occurs during dry years 20 to 29 in the simulation), it is possible that people would move their homes onto the waterless lake bed, maybe to be closer to cultivated fields. In such a situation, rapid rises in lake levels could be disastrous, threatening both livelihoods and houses. To avoid this, it will be necessary to educate local populations about lake-level changes.

Lower water levels, particularly in the dry season, will have a negative impact on navigation. Since the livelihoods of many people depend on shipping, strategies need to be developed to mitigate these impacts. These could include modification of ports as well as the ships themselves to enable them to operate at lower water levels.

The results show that as future irrigation increases, even though hydropower is given a higher priority, assured supplies for electricity generation will reduce. Although decisions

concerning water allocation should not be guided by economic concerns alone, economic valuation can help to guide allocations by providing a common point of reference and highlighting trade-offs between competing needs (Turner et al. 2004). Consequently, it would be extremely beneficial for a future study to undertake a detailed analysis of the economic implications of increased irrigation versus the reduced reliability of electricity generation. For completeness such an assessment should also include planned irrigation schemes in the Beles catchment.

The results indicate that the allowance for VEF over the Tis Issat Falls reduces the availability of water for both hydropower and irrigation, and causes increased drawdown of the lake. In the FDS, the VEF reduces the average lake levels by an additional 0.37 m and the average surface area of the lake by an additional 26 km^2 (i.e., 2,600 ha). This is over and above the reductions resulting from the TBF and will certainly exacerbate the adverse environmental and social impacts arising from drawdown of the lake. Therefore, a potential trade-off exists between the lake ecosystem and the ecosystem of the upper Abay River and the Falls. Since the livelihoods and well-being of many people are directly dependent on the ecological characteristics of both ecosystems, careful consideration needs to be given to determining how the water is best utilized. This requires much more detailed analyses of both the environmental and social consequences of water allocation patterns and very careful assessment of the implications for the livelihoods of the poor.

In this study, no consideration was given to the possible impacts of climate change. Currently, there is great uncertainty about the likely impacts of climate change in the Abay Basin and in Ethiopia in general. Results from Global Climate Models (GCMs) are contradictory; some show increases in rainfall whilst others show decreases. A recent study of 17 GCMs indicated that precipitation changes between -15 and +14% which, compounded by the high climatic sensitivity of the basin, translated into changes in annual flow of the Abay at the Sudan border between -60 and +45% (Elshamy et al. 2008). Kim et al. (2008) found a generally increasing trend in both precipitation and runoff in the northern part of

the basin. Other studies have found a decline in the runoff into Lake Tana (Shaka 2008). To date, no studies have been conducted into the possible changes in water demand arising from changes in temperature and rainfall in the Lake Tana catchment (e.g., for irrigation).

The water resources of the Lake Tana catchment are highly vulnerable to changes in rainfall and hence runoff (Kebede et al. 2006). The lack of certainty in trends in rainfall and runoff greatly complicates water resources planning and

management in what is already an uncertain environment. Climate change means that stationarity (i.e., the idea that flows fluctuate within an unchanging envelope of variability) can no longer be assumed and necessitates that all future water resources development is adaptable. Further research is needed to improve quantitative understanding of the impacts of climate change on water resources and to fulfil the pragmatic information needs of water managers and decision-makers.

Concluding Remarks

Whilst acknowledging the significant contribution that the Chara Chara Weir has made to the socioeconomic development in Ethiopia, and hence poverty alleviation, the results of this study have provided some indication of the ecological and social costs of both current and likely future water resources development in the basin. Although largely unreported, there is no doubt that operation of the Chara Chara Weir and diversions of water to the Tis Abay power stations, have, in common with almost all infrastructure development, resulted in some negative environmental and social impacts. This information may not have been available to decision-makers in the past, but disregarding these details distorts the true economic costs of development and also reduces the scope for successful mitigation.

In future, there is significant potential for further socioeconomic development based on increased utilization of water in the catchment. However, great care is needed to ensure that such development is sustainable and does not adversely impact those communities that depend on the natural resources of the lake and the rivers that feed into it. The predicted drop in average water levels of 0.44 m, and much more in prolonged dry periods, could have significant adverse ecological and social

consequences. In order to make informed decisions about the desired ecological state of the lake and the upper reaches of the Abay River, very detailed environmental and social impact assessments must be conducted. To be comprehensive, such evaluations must go beyond simple cost-benefit analyses and also include intangible benefits that cannot be expressed in monetary terms. It is also important that decision-making processes facilitate the involvement of local people in order that their concerns can be adequately addressed.

This study has highlighted the value of integrated approaches to assessing the impacts of planned development. Wise management of water resources requires decision-makers to make difficult choices that balance the needs of national development with the needs of local people. Research can be useful in contributing to the decision-making process by highlighting the consequences, including trade-offs, associated with different options. Hence, such research has an important role to play in determining how water resources development can best contribute to obtaining reliable and sustainable sources of water, food and energy, whilst simultaneously avoiding and mitigating harmful impacts.

References

- Abebe, W. B.; McCartney, M. P.; Doueven, W. J. A. M.; Leentvaar, J. 2008. EIA follow-up in the Koga Irrigation project, Ethiopia. Proceedings of the 2nd International Forum on Water and Food (Addis Ababa November 9-14, 2008). Vol. II. 52-55 pp.
- Alemayehu, T. 2008. Application of the WEAP model to assess the water resource implications of planned development in Lake Tana sub-basin, Ethiopia. MSc thesis, Environmental Science Program, Addis Ababa University.
- Allen, R. G.; Pereira, L. S.; Raes, D.; Smith, M. 1998. *Crop evapotranspiration: guidelines for computing crop water requirements*. FAO Irrigation and Drainage Paper 56. Rome, Italy: Food and Agriculture Organization of the United Nations.
- Awulachew, S. B.; McCartney, M.; Steenhuis, T. S.; Ahmed, A. A. 2008. *A review of hydrology, sediment and water resource use in the Blue Nile Basin*. Colombo, Sri Lanka: International Water Management Institute. 87p. (IWMI Working Paper 131).
- BCEOM (Egis Bceom International). 1998. Abbay river basin integrated development master plan, section II, volume V-water resources development, part 1- irrigation and drainage. Ministry of Water Resources, Addis Ababa, Ethiopia.
- Bellier, C.; Howard, H.; Kennedy, R.; Donkin. 1997. Tis Abay II hydroelectric project, environmental impact assessment. Federal Democratic Republic of Ethiopia, Ministry of Water Resources, Addis Ababa, Ethiopia.
- Bergkamp, G.; McCartney, M.; Dugan, P.; McNeely, J.; Acreman, M. 2000. *Dams, ecosystem functions and environmental restoration*. Thematic Review II.1. Cape Town, South Africa: World Commission on Dams.
- Berhanu, T.; Ralphe, L.; Girma, Z. 2001. Development initiatives and challenges for sustainable resource management and livelihood in Lake Tana region of Northern Ethiopia. Proceeding of wetland awareness creation and activity identification workshop in Amhara Regional State, January 23, 2001, Bahir Dar, Ethiopia.
- Block, P. J.; Strzepek, K.; Rajagopalan, B. 2007. *Integrated management of the Blue Nile Basin in Ethiopia: Hydropower and irrigation modeling*. Washington DC, USA: International Food Policy Research Institute. 23p. (IFPRI Discussion Paper 00700).
- CSA (Central Statistics Authority). 2003. Ethiopian agricultural sample enumeration, 2001/2002 results for Amhara region, statistical reports on area and production of crops, part II B. Addis Ababa, Ethiopia: Central Statistics Agency.
- DWAF (Department of Water Affairs and Forestry). 1999. *Resource Directed Measures for Protection of Water Resources – Volume 8: Classification System for Water Resources*. Pretoria, South Africa: DWAF.
- Elshamy, M. E.; Seirstad, I. A.; Sorteberg, A. 2008. Impacts of climate change on Blue Nile flows using bias-corrected GCM scenarios. *Hydrology and Earth System Sciences* 5: 1407-1439.
- EPLAUA (Environmental Protection, Land Administration and Use Authority). 2004. Water level reduction of Lake Tana and its environmental impacts. Bahir Dar, Ethiopia.
- EPLAUA. 2006. Ecological significances, threats and management options of Lake Tana-associated wetlands. Bahir Dar, Ethiopia.
- EWNHS (Ethiopian Wildlife and Natural History Society). 1996. Important bird areas of Ethiopia, First inventory. Addis Ababa, pp 103-107.
- Gebre, A.; Getachew, D.; McCartney, M. P. 2007. *Chara Chara stakeholder survey*. Report for CPWF project 36: Improved planning of large dam operation: using decision support systems to optimize livelihood benefits, safeguard health and protect the environment. Colombo, Sri Lanka: International Water Management Institute (IWMI).

- Gichuki, F.; McCornick, P. G. 2008. International Experiences of Water Transfers: Relevance to India, In: Amarasinghe, U. A.; Sharma, B. R., eds. 2008. *Strategic analyses of the National River Linking Project (NRLP) of India. Proceedings of the Workshop on Analyses of Hydrological, Social and Ecological Issues of the NRLP*. Colombo, Sri Lanka: International Water Management Institute.
- Grey, D.; Sadoff, C. 2006. *Water for growth and development*. A theme document of the 4th World Water Forum. Mexico City, Mexico. 56 pp.
- Hughes, D. A.; Hannart, P. 2003. A desktop model used to provide an initial estimate of the ecological in-stream flow requirements of rivers in South Africa. *Journal of Hydrology* 270(3-4): 167-181.
- Hughes, D. A. 2001. Providing Hydrological Information and Data Analysis Tools for the Determination of the Ecological In-stream Flow Requirements for South African Rivers. *Journal of Hydrology* 241(1-2): 140-151.
- ICOLD (International Commission on Large Dams). 2003. World Register of Dams, 2003. Paris, France: International Commission on Large Dams.
- Jha, R.; Sharma, K. D.; Singh, V. P. 2008. Critical appraisal of methods for the assessment of environmental flows and their application in two river systems of India. *KSCE Journal of Civil Engineering* 12(3): 213-219.
- Kashaigili, J. J.; McCartney, M. P.; Mahoo, H. F. 2007. Estimation of environmental flows in the Great Ruaha River Catchment, Tanzania. *Journal of Physics and Chemistry of the Earth* 32: 1007-1014.
- Kebede, S.; Travi, Y.; Alemayehu, T.; Marc, V. 2006. Water balance of Lake Tana and its sensitivity to fluctuations in rainfall, Blue Nile Basin, Ethiopia. *Journal of Hydrology* 316: 233-247.
- Kim, U.; Kaluarachchi, J. J. .; Smakhtin, V. U. 2008. *Climate change impacts on hydrology and water resources of the upper Blue Nile Basin, Ethiopia*. Colombo, Sri Lanka: International Water Management Institute. 27p. (IWMI Research Report 126).
- King, J.; Louw, M.D. 1998. Instream flow assessments for regulated rives in South Africa using the Building Block Methodology. *Aquatic Ecosystem Health and Management* 1: 109-124.
- King, J.; McCartney, M. P. 2007. Dams, ecosystems and livelihoods. *International Journal of River Basin Management* 5(3): 167-168.
- King, J.; Tharme, R. E.; de Villiers, M. S. 2000. *Environmental flow assessments for rivers: manual for the building block methodology*. Water Research Commission Technology Transfer Report No. TT 131/00, Pretoria, South Africa.
- Kleynhans, C. J. 1996. A qualitative procedure for the assessment of the habitat integrity status of the Luvuvhu River (Limpopo system, South Africa). *Journal of Aquatic Ecosystem Health* 5: 41-54.
- LakeNet. 2004. Lake Tana Symposium. Bahir Dar University, Ethiopia.
- McCartney, M. P.; Awulachew, S. 2006. Improving dam planning and operation in the Nile Basin through the use of decision support systems. In: *The role of the River Nile in Poverty Reduction and Economic Development in the Region*. Proceedings of the Nile Basin Development Forum, Addis Ababa, Ethiopia, 30 November – 02 December 2006. pp. 309-324.
- McCartney, M. P.; Alemayehu, T.; Awulachew, S. B.; Seleshi, Y. 2009. Evaluation of current and future water resource development in the Blue Nile. Proceedings of the Waternet Conference. Entebbe, Uganda, 28-30 October 2009 .
- MoFED (Ministry of Finance and Economic Development). 2006. A plan for accelerated and sustained development to end poverty (PASDEP), (2005/06-2009/10), volume I. Addis Ababa, Ethiopia.
- Mott MacDonald. 2004. Koga irrigation project interim report. Ministry of Water Resource, Addis Ababa, Ethiopia.
- Nilsson C.; Jansson, R.; Zinko, U. 1997. Long-term responses of river-margin vegetation to water-level regulation. *Science* 276: 798-800.

- Richter, B. D.; Baumgartner, J. V.; Wiginton, R.; Braun, D. P. 1997. How much water does a river need? *Freshwater Biology* 37: 231-249.
- Salini and Mid-day 2006. Environmental impact assessment for Beles multipurpose project. Addis Ababa, Ethiopia: Ethiopian Electric and Power Corporation.
- SEI (Stockholm Environment Institute). 2007. WEAP: Water Evaluation and Planning system – user guide. Boston, USA: Stockholm Environment Institute.
- Shaka, A. 2008. Assessment of climate change impacts on the hydrology of the Gilgel Abbay catchment in the Lake Tana Basin, Ethiopia. MSc thesis. University of Twente, Faculty of Geo-Information Science and Earth Observation, Netherlands. 72 pp.
- Shiferaw, A. 2007. *Environmental flow assessment at the source of the Blue Nile River, Ethiopia*. MSc thesis. Addis Ababa University, Ethiopia. 64 pp.
- Smakhtin, V. U.; Shipakar, R. L.; Hughes, D. A. 2006. Hydrology based assessment of environmental flows: an example from Nepal. *Hydrological Sciences Journal* 51(2): 207-222.
- SMEC (Snowy Mountains Engineering Corporation). 2008. Hydrological Study of the Tana-Beles sub-basins, main report. Addis Ababa, Ethiopia: Ministry of Water Resources.
- Staussny, M. L. J. 1996. An overview of freshwater biodiversity: with some lessons from African fishes. *Fisheries* 21: 7-13.
- Tharme, R. 2003. A global perspective on environmental flow assessment: emerging trends in the development and application of environmental flow methodologies for rivers. *River Research and Applications* 19: 397-441.
- Turner, K.; Georgiou, S.; Clark, R.; Brouwer, R.; Burke, J. 2004. Economic valuation of water resources in agriculture. From the sectoral to a functional perspective of natural resource management. FAO Water Reports 27. Rome, Italy: Food and Agriculture Organization of the United Nations.
- Ward, J. V.; Stanford, J. A. 1995. Ecological connectivity in alluvial river ecosystems and its disruption by flow regulation. *Regulated Rivers: Research and Management* 11(1): 105-119.
- WWDSE (Water Works Design and Supervision Enterprise) and ICT (Intercontinental Consultants and Technocrats India (Pvt) Ltd.). 2008. Gumara irrigation project, final feasibility study report, volume III: water resources (a), annexure-7: meteorological and hydrological studies. Addis Ababa, Ethiopia.
- WWDSE (Water Works Design and Supervision Enterprise) and TAHAL Consulting Engineers Ltd. 2008a. Lake Tana sub-basin four dams project, final feasibility report for Ribb irrigation project, volume III: hydrological report. Addis Ababa, Ethiopia.
- WWDSE and TAHAL Consulting Engineers Ltd. 2008b. Lake Tana sub-basin four dams project, final feasibility report for Megech irrigation project, volume III: hydrological report. Addis Ababa, Ethiopia.
- World Bank. 2008. Project appraisal document on a proposed credit in the amount of SDR 27.4 million (US\$45 million equivalent) to the Federal Republic of Ethiopia for a Tana & Beles integrated water resources development project. Washington DC, USA: World Bank.
- World Bank. 2004. The water resources sector strategy: an overview. Washington, DC, USA: World Bank.
- WCD (World Commission on Dams). 2000. Dams and Development: a new framework for decision-making. The report of the World Commission on Dams. London, UK: Earthscan Publications, Thanet Press.
- Yates, D.; Sieber, J.; Purkey, D.; Huber-Lee, A. 2005. WEAP 21 a demand, priority and preference driven water planning model, part 1: model characteristics. *Water International* 30: 487-500.

IWMI Research Reports

134. Evaluation of Current and Future Water Resources Development in the Lake Tana Basin, Ethiopia. Matthew McCartney, Tadesse Alemayehu, Abeyu Shiferaw and Seleshi Bekele Awulachew. 2010.
133. Mapping Drought Patterns and Impacts: A Global Perspective. Nishadi Eriyagama, Vladimir Smakhtin and Nilantha Gamage. 2009.
132. *Malaria Transmission in the Vicinity of Impounded Water: Evidence from the Koka Reservoir, Ethiopia*. Solomon Kibret, Matthew McCartney, Jonathan Lautze and Gayathree Jayasinghe. 2009.
131. Implementing Integrated River Basin Management: Lessons from the Red River Basin, Vietnam. François Molle and Chu Thai Hoanh. 2009.
130. Economic Gains of Improving Soil Fertility and Water Holding Capacity with Clay Application: The Impact of Soil Remediation Research in Northeast Thailand. Rathinasamy Maria Saleth, Arlene Inocencio, Andrew Noble and Sawaeng Ruaysoongnern. 2009.
129. Adaptive Water Resource Management in the South Indian Lower Bhavani Project Command Area. Mats Lannerstad and David Molden. 2009.
128. Importance of Irrigated Agriculture to the Ethiopian Economy: Capturing the Direct Net Benefits of Irrigation. Fitsum Hagos, Godswill Makombe, Regassa E. Namara and Seleshi Bekele Awulachew. 2009.
127. Drivers and Characteristics of Wastewater Agriculture in Developing Countries: Results from a Global Assessment. Liqa Raschid-Sally and Priyantha Jayakody. 2008.
126. Climate Change Impacts on Hydrology and Water Resources of the Upper Blue River Basin, Ethiopia. Ungtae Kim, Jagath J. Kaluarachchi and Vladimir U. Smakhtin. 2008.
125. The Lower Krishna Basin Trajectory: Relationships between Basin Development and Downstream Environmental Degradation. Jean-Philippe Venot, Bharat R. Sharma and Kamineni V. G. K. Rao. 2008.
124. Institutions, Impact Synergies and Food Security: A Methodology with Results from the Kala Oya Basin, Sri Lanka. Rathinasamy Maria Saleth, Ariel Dinar, Susanne Neubert, Bandi Kamaiah, Seenithamby Manoharan, Sarath Abayawardana, Ranjith Ariyaratne and Shyamalie de Silva. 2007.

Electronic copies of IWMI's publications are available for free.

Visit

www.iwmi.org/publications/index.aspx

Related Publications

Awulachew, S. B.; McCartney, M.; Steenhuis, T. S.; Ahmed, A. A. 2008. ***A review of hydrology, sediment and water resource use in the Blue Nile Basin***. Colombo, Sri Lanka: International Water Management Institute (IWMI). 81p. (IWMI Working Paper 131).

www.iwmi.org/Publications/Working_Papers/working/WOR131.pdf

Awulachew, S. B.; Yilma, A. D.; Loulseged, M.; Loiskandl, W.; Ayana, M.; Alamirew, T. 2007. ***Water resources and irrigation development in Ethiopia***. Colombo, Sri Lanka: International Water Management Institute (IWMI). 66p. (IWMI Working Paper 123).

www.iwmi.org/Publications/Working_Papers/working/WP123.pdf

Kim, U.; Kaluarachchi, J. J.; Smakhtin, V. U. 2008. ***Climate change impacts on hydrology and water resources of the Upper Blue Nile River Basin, Ethiopia***. Colombo, Sri Lanka: International Water Management Institute (IWMI). 21p. (IWMI Research Report 126).

www.iwmi.org/Publications/IWMI_Research_Reports/PDF/PUB126/RR126.pdf

McCartney, M. P.; Arranz, R. 2007. ***Evaluation of historic, current and future water demand in the Olifants River Catchment, South Africa***. Colombo, Sri Lanka: International Water Management Institute. 48p. (IWMI Research Report 118).

www.iwmi.org/Publications/IWMI_Research_Reports/PDF/PUB118/RR118.pdf

Postal Address

P O Box 2075
Colombo
Sri Lanka

Location

127 Sunil Mawatha
Pelawatta
Battaramulla
Sri Lanka

Telephone

+94-11-2880000

Fax

+94-11-2786854

E-mail

iwmi@cgiar.org

Website

www.iwmi.org