



**AgEcon** SEARCH  
RESEARCH IN AGRICULTURAL & APPLIED ECONOMICS

*The World's Largest Open Access Agricultural & Applied Economics Digital Library*

**This document is discoverable and free to researchers across the globe due to the work of AgEcon Search.**

**Help ensure our sustainability.**

Give to AgEcon Search

AgEcon Search

<http://ageconsearch.umn.edu>

[aesearch@umn.edu](mailto:aesearch@umn.edu)

*Papers downloaded from **AgEcon Search** may be used for non-commercial purposes and personal study only. No other use, including posting to another Internet site, is permitted without permission from the copyright owner (not AgEcon Search), or as allowed under the provisions of Fair Use, U.S. Copyright Act, Title 17 U.S.C.*

**Working Paper Series**



**Working Paper 2006:2(5)**

**The impact of property rates on  
agricultural land, focusing on  
the Eastern Cape**

*Eisenburg  
June 2006*

# PROVIDE

# PROJECT

The Provincial Decision-making Enabling Project

## Overview





The Provincial Decision-Making Enabling (PROVIDE) Project aims to facilitate policy design by supplying policymakers with provincial and national level quantitative policy information. The project entails the development of a series of databases (in the format of Social Accounting Matrices) for use in Computable General Equilibrium models.

The National and Provincial Departments of Agriculture are the stakeholders and funders of the PROVIDE Project. The research team is located at Elsenburg in the Western Cape.

## PROVIDE Research Team

Project Leader:	Cecilia Punt
Senior Researchers:	Kalie Pauw Melt van Schoor
Young Professional:	Bonani Nyhodo
Technical Expert:	Scott McDonald
Associate Researchers:	Lindsay Chant Christine Valente

## PROVIDE Contact Details

	Private Bag X1 Elsenburg, 7607 South Africa
	<a href="mailto:provide@elsenburg.com">provide@elsenburg.com</a>
	+27-21-8085191
	+27-21-8085210

For the original project proposal and a more detailed description of the project, please visit [www.elsenburg.com/provide](http://www.elsenburg.com/provide)

# The impact of property rates on agricultural land, focusing on the Eastern Cape<sup>1</sup>

## Abstract

*Municipalities across the country are in the process of implementing property rates on all property, following the Local Government: Property Rates Act (2004) that came into effect on 1 July 2005. This study investigates the economic impact of property rates on agricultural land, using a static computable general equilibrium model. The direct and indirect effects of property rates on the macro-economy, factor incomes, household welfare, prices and agricultural output are discussed. The results indicate that the impact of raising property rates depends on the use made of the additional revenue by government. There is a small negative impact on the economy and the overall welfare of households decline if government spends the additional revenue. On the other hand, if government allows a compensating reduction in sales taxes, the impact on the economy is positive and the overall welfare of households increase. The impact on the welfare of households in the Eastern Cape is similar to that of the overall welfare of households in South Africa for the different uses made of the additional revenue. Introducing property rates has a marginal progressive impact on the welfare of households in the event of an increase in government expenditure or a reduction in sales taxes. Property rates do not influence prices directly and, irrespective of the use made of the revenue, the impact on production and resource allocation is limited.*

---

<sup>1</sup> The main authors of this paper are Sanri Reynolds (Western Cape Project Committee member) and Melt van Schoor.

*Table of contents*

<b>Executive Summary .....</b>	<b>iv</b>
<b>1. Introduction .....</b>	<b>1</b>
<b>2. History of land taxes in South Africa .....</b>	<b>2</b>
2.1. Properties of the Local Government: Municipal Property Rates Act, 2004 .....	2
<b>3. Some aspects of property rates on agricultural land .....</b>	<b>3</b>
<b>4. Computable general equilibrium model and data .....</b>	<b>5</b>
4.1. CGE model .....	5
Behavioural relationships .....	6
Price and quantity relationships .....	9
4.2. Data (Social Accounting Matrix) .....	11
<b>5. Policy scenario's .....</b>	<b>12</b>
5.1. Scenario's .....	12
5.2. Closure rules .....	13
<b>6. Model results .....</b>	<b>14</b>
6.1. Results relating to increased government expenditure ("active" closure rule) ....	15
6.1.1. Impact on selected macroeconomic indicators .....	15
6.1.2. Impact on incomes of factors .....	16
6.1.3. Impact on the welfare of households .....	19
6.1.4. Impact on prices .....	20
6.1.5. Impact on agricultural output .....	21
6.2. Results relating to the tax replacements ("neutral" and "Stax" closures) .....	22
6.2.1. Macroeconomic impact .....	22
6.2.2. Impact on incomes of factors .....	23
6.2.3. Impact on welfare of households .....	24
6.2.4. Impact on prices .....	26
6.2.5. Impact on agricultural output .....	26
<b>7. Conclusion .....</b>	<b>27</b>
<b>8. References .....</b>	<b>29</b>
<b>9. Appendices .....</b>	<b>31</b>
9.1. Appendix A: SAM Accounts .....	31
9.2. Appendix B: Classification of occupations into skill level categories .....	35
9.3. Appendix C: Percentage change in the welfare of households .....	35

**List of Figures**

Figure 1: Supply and demand for land .....	4
Figure 2: Price relationships for a standard model with commodity exports .....	10
Figure 3: Quantity relationships for a standard model .....	11
Figure 4: Impact on selected macroeconomic variables when government spends the additional revenue, at a 3% property rate on the value of land .....	16
Figure 5: Effect on income of land in the Eastern Cape (YFDISP) when government spends the additional revenue .....	17
Figure 6: Changes in incomes of capital and labour factors in the Eastern Cape (YF) when government spends the additional revenue, at a 3% property rate on the value of land ..	18
Figure 7: Changes in real consumption expenditure of households when government spends the additional revenue, at a 3% property rate on the value of land .....	20

Figure 8: Changes in the consumer prices (PQD) of selected commodities when government spends the addition revenue, at a 3% property rate on the value of land ..... 21

Figure 9: Changes in the domestic production (QXC) when government spends the additional revenue, at a 3% property rate on the value of land ..... 22

Figure 10: Impact on selected macroeconomic indicators for the tax replacement closures, at a 3% property rate on the value of land ..... 23

Figure 11: Changes in the incomes of labour factors and capital for the tax replacement closures, at a 3% property rate on the value of land ..... 24

Figure 12: Changes in real consumption expenditure of households when allowing a compensating reduction in sales taxes, at a 3% property rate on the value of land ..... 25

Figure 13: Changes in the prices of selected commodities (PQD) when allowing a compensating reduction in sales taxes, at a 3% property rate on the value of land ..... 26

Figure 14: Changes in agricultural output (QXC) when allowing a compensating reduction in sales taxes, at a 3% property rate on the value of land..... 27

**List of Tables**

Table 1: Relationships for the computable general equilibrium model ..... 8

Table 2: Changes in the number of employment opportunities when government spends the additional revenue, at a 3% property rate on the value of land ..... 18

Table 3: Changes in the number of employment opportunities when allowing a compensating reduction in sales taxes, at a 3% property rate on the value of land ..... 24

## Executive Summary

After many years of debate, property rates on agricultural land are currently levied in large parts of South Africa, following the promulgation of the Local Government: Property Rates Act, 2004. This Act became effective on 01 July 2005 and local municipalities are in the process of implementing the rates. However, there is still widespread concern on the impact of property rates on rural land on the economy.

This study uses a computable general equilibrium (CGE) model calibrated with a social accounting matrix to determine the impact of rural property rates on the welfare of households, employment, prices and agricultural production. The property rates are levied on all agricultural land in South Africa, but the discussion focuses on the Eastern Cape. The rates are levied from 0% to 3%, increasing in 0.5 percentage point increments. According to the data used for this study, a tax rate exceeding 3% would tax away the economic profit to holding agricultural land in some provinces in South Africa. A CGE model is a model of the real economy, implicitly assuming that there will be no effect on the financial side of the economy.

The results show that the impact of property rates on the economy depends on the use made of the additional revenue by government. Levying a 3% property rate on the value of agricultural land will have a small impact on the macro-economy when government spends the additional revenue of R2 063 million. Total welfare of households, measured by real consumption expenditure, will decrease by R1 625 million (0.30%) and real expenditure of households in the Eastern Cape will decline by R145 million (0.30%); all representative households in this province will be worse off.

The changes in the welfare of households are driven largely by changes in the incomes of factors, including labour, capital and land. Though land contributes less than 0.5% to the total income of households in South Africa, the large negative impact on the income of land dominates the changes in the incomes of households. The primary recipients of income from land lose out most as well as those households who are depending on land for a relatively large share of their income. Increasing the factor tax has a marginal progressive impact on real consumption expenditure of households, but the amount redistributed is so small that the shifts in demand patterns are negligible and therefore the changes the prices of commodities are only marginal.

Introducing property rates on agricultural land does not influence prices directly, but it is only the small redistributive impact that results in small secondary price effects; therefore the effects on prices, production output and the allocation of resources are limited. Agricultural

activities in the Eastern Cape will contract marginally and the production output of livestock, milk and cream, poultry and “other agriculture” (including animal fibres, wild flowers, compost and firewood) will decline by between 0.11% and 0.15%. The number of job losses is estimated at 2 696 of which 1 436 will be in the agricultural sector. The number of job losses in the Eastern Cape is estimated at 238.

Instead of spending the additional revenue, government may lower another tax instrument such as sales taxes or income taxes. In the event of allowing a compensating reduction in income taxes, incomes are transferred from the landowners to the income taxpayer, with the higher income households receiving the largest reductions in their tax rates as the rates are reduced equi-proportionately. However, income from land accrues primarily to higher income households and therefore the redistributive impact is close to neutral. Since there is virtually no distributional impact and since property rates do not directly influence prices, the effect on the economy is very small.

The impact on the economy is bigger, though still small, in the case of a compensating reduction in sales taxes *vis-à-vis* a reduction in income taxes. Lowering sales taxes equi-proportionately directly influences the prices of commodities, leading to changes in wages and employment. This influences household welfare in two ways: changes in employment and wages result in changes in factor and household incomes, and changes in the prices of commodities result in changes in real consumption expenditure of households. The results indicate that allowing a compensating reduction in sales taxes has a progressive impact on household welfare, similar to the redistributive impact in the event of increased government expenditure; however, lowering sales taxes results in an increase in household welfare as total real consumption expenditure of households increases by R329 million (0.06%). Total real consumption expenditure of households in the Eastern Cape increases by R9 million (0.02), but some representative households are worse off. A compensating reduction in sales taxes will result in 18 838 additional employment opportunities of which 1 755 will be in the Eastern Cape.



## 1. Introduction

After many years of debate, property rates on agricultural land are currently levied in large parts of South Africa, following the promulgation of the Local Government: Property Rates Act, 2004<sup>2</sup>. This Act became effective on 01 July 2005<sup>3</sup> and local municipalities are in the process of implementing the rates. A number of studies (see Van Schalkwyk *et al.* (1998) and PE Technikon (2004)) have attempted to determine the implications of rural property rates, focusing on the financial implications for agricultural activities, and McDonald and Punt (2004) investigated the welfare implications of introducing property rates on agricultural land in the Western Cape. However, there is still widespread concern on the impact of property rates on the economy.

The aim of this study is to determine the direct and indirect effects of raising rural property rates on the economy. Though property rates are levied only on agricultural land, they will affect the entire economy (and all households) through forward and backward linkages. All representative households earn some income from agricultural land directly or indirectly; hence, the incomes of all households will be influenced by the rates. The direct influence is expected to be small, considering the small contribution income from land makes to total household income. The changes in the incomes of households result in changes in demand and thereby production, which lead to small changes in prices. Price changes affect wages and employment via the price formation system and these again affect factor incomes and incomes of households. We argue that since the direct impacts on household incomes are expected to be small and because property rates do not influence prices directly, the impact on the economy will be small resulting in limited shifts in production and resource allocation. In addition, we investigate the impact considering various possibilities as to how government may spend the additional revenue. A computable general equilibrium (CGE) model calibrated with a social accounting matrix (SAM) was used to quantify the direct and indirect effects of property rates on, among others, household welfare, employment, prices and agricultural output. The property rates are levied on all agricultural land in South Africa, but the discussion of the results focuses on the Eastern Cape.

This paper is structured as follows: Section 2 discusses the history of property rates in South Africa and the Local Government: Property Rates Act, 2004. Section 3 is a brief review of the economics of land; distinguishing between the user and the owner of land and the implications of a tax rate for these two entities and the value of land. The issue of using the inherent value of land, the agricultural use-value or the market value as tax base is addressed

---

<sup>2</sup> Government Gazette 26357 of 17 May 2004

<sup>3</sup> Government Gazette 27720 of 29 June 2005

also. Section 4 discusses the model and data used in this study, while section 5 relates to the various scenarios simulated and the model closure rules. Section 6 discusses the results and section 7 concludes.

## 2. History of land taxes in South Africa

Land tax has a long history in South Africa dating back to the involvement of the Dutch East Indian Company (DEIC) in the Cape of Good Hope during the 17<sup>th</sup> century. The various land taxes levied during the 1700's and 1800's included *recognitie* the Freeburghers had to pay to the DEIC for the use of land; auction tax of 2.5% on immovable assets; and local authorities (known as divisional councils since 1855 in the Cape province) levied taxes on land under their jurisdiction to maintain roads and certain health services.

After 1910 the importance of land taxes diminished, and in 1934 the payment of *recognitie* was abolished to bring some tax relief to farmers after a period of drought and the Great Depression. In 1948 provincial councils were authorised to levy a tax on immovable assets. Since all land lies within provincial boundaries, all agricultural land was subject to this tax. In practice, however, local authorities taxed immovable assets and since these authorities were located in urban areas, they did not cover all rural land. In other words, agricultural land was not officially subject to taxation until the implementation of the Local Government: Municipal Rates Act (2004) on 01 July 2005.

### 2.1. Properties of the Local Government: Municipal Property Rates Act, 2004

The Local Government: Municipal Property Rates Act, 2004 (Act 6 of 2004) was promulgated in May 2004, following an investigation by the Land Tax Sub-Committee of the Commission of Inquiry into Certain Aspects of the Tax Structure of South Africa (the Katz Commission<sup>4</sup>). They investigated the rationale for and nature of a land tax, the economic effects, revenue raising potential, re-distributional qualities and administrative aspects. The Sub-Committee submitted its Interim Report in October 1995 and this was followed by their final report in July 1998.

The Constitution of South Africa gives municipalities the power to value and rate property in their area of jurisdiction<sup>5</sup>; hence, the Municipal Property Rates Act (2004) does not give municipalities the power to rate property; it merely replaces the old system of property valuation and rating based on the old Provincial Ordinances. In other words, the new Act regulates the original power vested in municipalities by the Constitution.

---

<sup>4</sup> The Katz Commission was announced on 22 June 1994 and tasked by government to investigate various aspects of taxation in South Africa.

<sup>5</sup> See Section 229(2) of the Constitution.

In terms of the Act, all property owners, including commercial, residential, agriculture, government and public service infrastructure, are liable for the payment of rates. The property rates are levied annually and expressed as a cent amount in the Rand levied on the market value of immovable property (including land and improvements). Local municipalities determine this cent amount in the Rand, taking into account public comments, submissions and inputs on the draft rates policy set up by the Council. Local municipalities are also responsible for implementing and collecting the rates. Property rates are the most important source of revenue for municipalities and municipalities spend it on the provision of services, e.g. installing and maintaining streets, roads, lighting, operating clinics, recreational activities and cemeteries, as well as financing administrative operations.

The legislation does allow room for municipal councils to provide for rebates, exemptions and reductions in their rates policy, depending on their local conditions and demand. For example, municipalities can consider granting rebates, exemptions or reductions to owners of agricultural properties, taking into account “the extent of services provided by the municipality in respect of such properties, the contribution of agriculture to the local economy, the extent to which agriculture assists in meeting the service delivery and development obligations of the municipality and the contribution of agriculture to the social and economic welfare of farm workers” (DPLG, 2004a: 16).

The legislation also provides for the phasing-in of requirements on newly rateable property over a period of three or four financial years. Newly rateable property is rateable property on which property rates were not levied before 30 June 2005, excluding property that was incorrectly omitted from the valuation roll.

### **3. Some aspects of property rates on agricultural land**

An understanding of the economic implications of property rates requires a brief review of the economics of land use and ownership in the context of the incidence of the tax. The proposed property rates are a tax on ‘ownership’ not ‘use’, i.e., the taxes are paid by the owners and not the users of land; hence it is necessary to maintain a conceptual distinction between the roles of the owner and the user of land even if the owner and the user are the same person. This conceptual distinction is common among economists and dates back to the founding of modern economics, i.e., Adam Smith and David Ricardo, and was fundamental to the analyses of the economics of land developed by Ricardo that still forms the basis of land economics. The key conclusion from this form of analyses is that property rates paid by the owners of land will not affect resource allocation decisions. This can be illustrated in a simple diagram (Figure 1).

Assume for the moment that the only use of land is for agriculture and that the only reason to own land is for its use in agriculture. Because the supply of land is fixed,  $Q$ , any change in the marginal value product of land, e.g., a shift in demand from  $D_N$  to  $D_N'$  will not induce a change in the use of land but will simply result in a reduction in the rental price of land, e.g., from  $P$  to  $P'$ . The introduction of property rates does not impact upon the marginal product of land and only impacts upon the marginal value product through any induced changes in commodity prices, and hence there is no direct affect on the demand for land. Moreover, since the induced price changes are likely to be small, the affect on the demand curve for land will also be small. Consequently, provided the tax rate is less than  $P$ , there will be no incentive to reallocate resources, and the only cause of any changes in the return to land in agriculture will come about through the (small) changes in commodity prices. Thus from the users perspective property rates will have no impact on resource allocation decisions; this conclusion underpinned the arguments of the single tax ‘school’ of the 19<sup>th</sup> century associated with Henry George.

**Figure 1: Supply and demand for land**

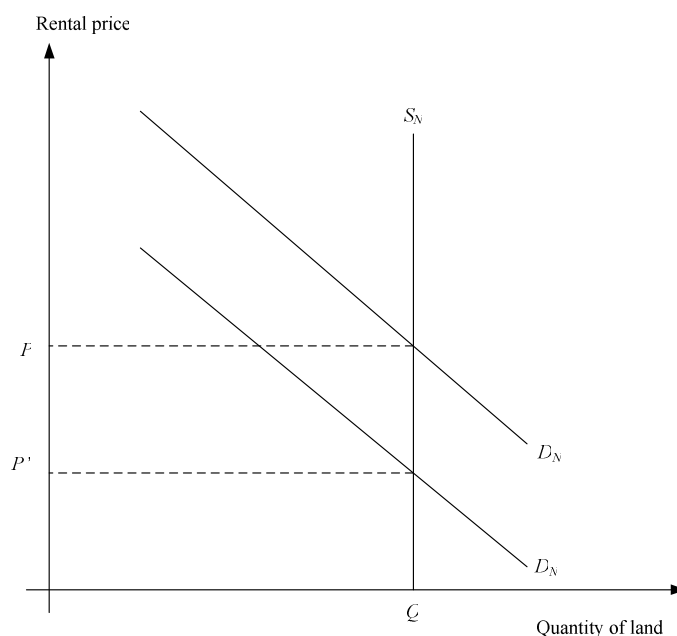

However, from the perspective of the owner of the land the situation is slightly different. The introduction of property rates puts a wedge between the rental price of land paid by the user and the after tax revenue of the owner; if the owner wishes to sell the land the realised rental income stream has diminished and hence the realisable sale price of land - its value – will have declined. One consequence of this is that the asset value of land will have declined. If the owner and the farmer are the same person, there is the potential for liquidity problems and eventual insolvency for farmers, since a large amount of farm debt is secured against land

values. This may precipitate an increase in the rate of foreclosures by banks, while increasing the difficulties some farmers may face when seeking to borrow to fund farming activities.

Continuing with the implied assumption that the market value of land is determined purely by its potential use as agricultural asset. In such a situation it may seem that the market value of land is an appropriate basis for the tax rate, but the value of land as an agricultural asset depends not only the inherent agricultural capacity of the land but also upon any improvements, e.g., buildings, drainage, irrigation, contour ploughing, etc. This means that the tax rate is also being levied upon capital invested in the land and hence it is no longer a pure tax on land, i.e., the theory above no longer strictly applies. One consequence of levying a tax on improvements is to provide a disincentive for farmers to improve land and increase the incentives for farmers to ‘mine’ previous improvements; ultimately, this will adversely affect the performance of the agricultural sector and hence social welfare.

Furthermore, the reasons to own land go beyond its use as an agricultural asset. It is argued that in addition to its value as agricultural asset that owners value land for its use as an amenity, for speculative purposes and for a variety of reasons associated with the intrinsic pleasure derived from owning land. All these reasons serve to raise the price of land above its value purely as an agricultural asset and hence to further distance the market value from the inherent agricultural value.

This raises the difficult issue of the identification of the appropriate basis for the calculation of property rates. Clearly, the theoretical optimum would be the inherent productive value of land, since this would ensure the absence of distortions in the incentives to invest in land/farm improvements. However, the market value of land also includes a valuation of land not related to agriculture that may justify taxation. Ultimately, it may be that the only practical alternative is to base the tax calculation on market values; if that is the case then the marginal tax rates will need to be substantially below the rate of return on the market value of land – how far below is a question that would justify evaluation.

#### **4. Computable general equilibrium model and data**

##### **4.1. CGE model**

The computable general equilibrium (CGE) model (see PROVIDE, 2005) is a member of the class of single country computable general equilibrium (CGE) models that are descendants of the approach to CGE modeling described by Dervis *et al.*, (1982). More specifically, the implementation of this model, using the GAMS (General Algebraic Modeling System) software, is a direct descendant and development of models devised in the late 1980s and early 1990s, particularly those models reported by Robinson *et al.*, (1990), Kilkenny (1991)

and Devarajan *et al.*, (1994). The model is a SAM based CGE model, wherein the SAM serves to identify the agents in the economy and provides the database with which the model is calibrated. The SAM also serves an important organisational role since the groups of agents identified by the SAM structure are also used to define sub-matrices of the SAM for which behavioural relationships need to be defined. As such the modelling approach has been influenced by Pyatt's 'SAM Approach to Modeling' (Pyatt, 1988).

The description of the model here is necessarily brief and proceeds in two stages. The first stage is the identification of the behavioural relationships; these are defined by reference to the sub matrices of the SAM within which the associated transactions are recorded. The second stage uses a pair of figures to explain the nature of the price and quantity systems for commodity and activity accounts that are embodied within the model.

### *Behavioural relationships*

While the accounts of the SAM determine the agents that can be included within the model, and the transactions recorded in the SAM identify the transactions that took place, the model is defined by the behavioural relationships. The behavioural relationships in this model are a mix of non-linear and linear relationships that govern how the model's agents will respond to exogenously determined changes in the model's parameters and/or variables. Table 1 summarises the model relationships by reference to the sub matrices of the SAM.

Households are assumed to choose the bundles of commodities they consume so as to maximise utility where the utility functions are Stone-Geary functions that allow for subsistence consumption expenditures, which is an arguably realistic assumption when there are substantial numbers of very poor consumers. The households choose their consumption bundles from a set of 'composite' commodities that are aggregates of domestically produced and imported commodities. These 'composite' commodities are formed as Constant Elasticity of Substitution (CES) aggregates that embody the presumption that domestically produced and imported commodities are imperfect substitutes. The optimal ratios of imported and domestic commodities are determined by the relative prices of the imported and domestic commodities. This is the so-called Armington assumption (Armington, 1969), which allows for product differentiation via the assumption of imperfect substitution (see Devarajan *et al.*, 1994). The assumption has the advantage of rendering the model practical by avoiding the extreme specialisation and price fluctuations associated with other trade assumptions. In this model South Africa is assumed to be a price taker for all imported commodities.

Domestic production uses a two-stage production process. In the first stage aggregate intermediate and aggregate primary inputs are combined using CES technology. Hence aggregate intermediate and primary input demands vary with the relative prices of aggregate

intermediate and primary inputs. At the second stage intermediate inputs are used in fixed proportions relative to the aggregate intermediate input used by each activity. The ‘residual’ prices per unit of output after paying for intermediate inputs, the so-called value added prices, are the amounts available for the payment of primary inputs. Primary inputs are combined to form aggregate value added using CES technologies, with the optimal ratios of primary inputs being determined by relative factor prices. The activities are defined as multi-product activities with the assumption that the proportionate combinations of commodity outputs produced by each activity/industry remain constant; hence for any given vector of commodities demanded there is a unique vector of activity outputs that must be produced. The vector of commodities demanded is determined by the domestic demand for domestically produced commodities and export demand for domestically produced commodities. Using the assumption of imperfect transformation between domestic demand and export demand, in the form of a Constant Elasticity of Transformation (CET) function, the optimal distribution of domestically produced commodities between the domestic and export markets is determined by the relative prices on the alternative markets. The model can be specified as a small country, i.e., price taker, on all export markets, or selected export commodities can be deemed to face downward sloping export demand functions, i.e., a large country assumption. The other behavioural relationships in the model are generally linear.

**Table 1: Relationships for the computable general equilibrium model**

	Commodities	Activities	Factors	Households	Enterprises	Government	Capital	RoW	Total	Prices
<b>Commodities</b>	0	Leontief Input-Output Coefficients	0	Utility Functions (Stone-Geary or CD)	Fixed in Real Terms	Fixed in Real Terms and Export Taxes	Fixed Shares of Savings	Commodity Exports (CET)	Commodity Demand	Consumer Commodity Price Prices for Exports
<b>Activities</b>	Domestic Production	0	0	0	0	0	0	0	Constant Elasticity of Substitution Production Functions	
<b>Factors</b>	0	Factor Demands (CES)	0	0	0	0	0	Factor Income from RoW	Factor Income	
<b>Households</b>	0	0	Fixed Shares of Factor Income	Fixed (Real) Transfers	Fixed (Real) Transfers	Fixed (Real) Transfers	0	Remittances	Household Income	
<b>Enterprises</b>	0	0	Fixed Shares of Factor Income	0	0	Fixed (Real) Transfers	0	Transfers	Enterprise Income	
<b>Government</b>	Tariff Revenue Export Taxes Commodity Taxes	Indirect Taxes on Activities Factor Use Taxes	Factor Income Taxes Fixed Shares of Factor Income Depreciation	Direct Taxes on Household Income	Direct Taxes on Enterprise Income	0	0	Transfers	Government Income	
<b>Capital</b>	0	0	0	Household Savings	Enterprise Savings	Government Savings (Residual)	0	Current Account 'Deficit'	Total Savings	
<b>Rest of World</b>	Commodity Imports	0	Fixed Shares of Factor Income	0	0	0	0	0	Total 'Expenditure' Abroad	
<b>Total</b>	Commodity Supply (Armington CES)	Activity Input	Factor Expenditure	Household Expenditure	Enterprise Expenditure	Government Expenditure	Total Investment	Total 'Income' from Abroad		
	Producer Commodity Prices Domestic and World Prices for Imports	Value Added Prices								



The model is set up with a range of flexible closure rules. The specific choices about closure rules used in this study are defined in the Policy Analysis section below.

### *Price and quantity relationships*

Figures 2 and 3 provide an overview of the interrelationships between the prices and quantities. The supply prices of the composite commodities ( $PQS_c$ ) are defined as the weighted averages of the domestically produced commodities that are consumed domestically ( $PD_c$ ) and the domestic prices of imported commodities ( $PM_c$ ), which are defined as the products of the world prices of commodities ( $PWM_c$ ) and the exchange rate ( $ER$ ) uplifted by *ad valorem* import duties ( $tm_c$ ). These weights are updated in the model through first order conditions for optima. The supply prices exclude sales, excise and fuel taxes, and hence must be uplifted by (*ad valorem*) sales taxes ( $ts_c$ ), excise taxes ( $tex_c$ ) and fuel taxes ( $tfue_c$ ) to reflect the composite consumer price ( $PQD_c$ ). The producer prices of commodities ( $PXC_c$ ) are similarly defined as the weighted averages of the prices received for domestically produced commodities sold on domestic and export ( $PE_c$ ) markets; the weights are updated in the model through first order conditions for optima. The prices received on the export market are defined as the products of the world price of exports ( $PWE_c$ ) and the exchange rate ( $ER$ ) less any export duties due, which are defined by *ad valorem* export duty rates ( $te_c$ ).

The average price per unit of output received by an activity ( $PX_a$ ) is defined as the weighted average of the domestic producer prices, where the weights are constant. After paying indirect/production/output taxes ( $tx_a$ ), this is divided between payments to aggregate value added ( $PVA_a$ ), i.e., the amount available to pay primary inputs, and aggregate intermediate inputs ( $PINT_a$ ). The factor prices paid by activities ( $WF_{f,a}$ ) constitute the components of value added, while total payments for intermediate inputs per unit of aggregate intermediate input are defined as the weighted sums of the prices of the inputs ( $PQD_c$ ).

**Figure 2: Price relationships for a standard model with commodity exports**

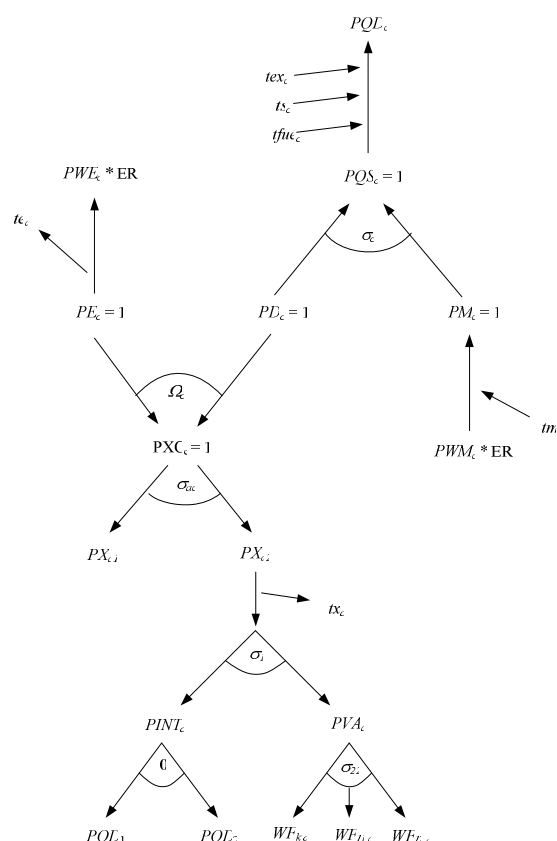

Total demands for the composite commodities,  $QQ_c$ , consist of demands for intermediate inputs,  $QINTD_c$ , consumption by households,  $QCD_c$ , enterprises,  $QENTD_c$ , and government,  $QGD_c$ , gross fixed capital formation,  $QINVD_c$ , and stock changes,  $dstocconst_c$ . Supplies from domestic producers,  $QD_c$ , plus imports,  $QM_c$ , meet these demands; equilibrium conditions ensure that the total supplies and demands for all composite commodities equate. Commodities are delivered to both the domestic and export,  $QE_c$ , markets subject to equilibrium conditions that require all domestic commodity production,  $QXC_c$ , to be either domestically consumed or exported.

The multi-product activities are modelled using the assumption that commodities are differentiated by (source) activity but that activities produce outputs in fixed proportions.<sup>6</sup> Hence the domestic production of a commodity ( $QXC_c$ ) is a CES aggregate of the quantities of that commodity produced by a number of different activities ( $QXAC_{a,c}$ ), which are produced by each activity in activity specific fixed proportions, i.e., the output of  $QXAC_{a,c}$  is a Leontief (fixed proportions) aggregate of the output of each activity ( $QX_a$ ).

<sup>6</sup> The model allows for the imposition of the alternative assumption that the ‘same’ commodities produced by different activities are homogenous.

**Figure 3: Quantity relationships for a standard model**

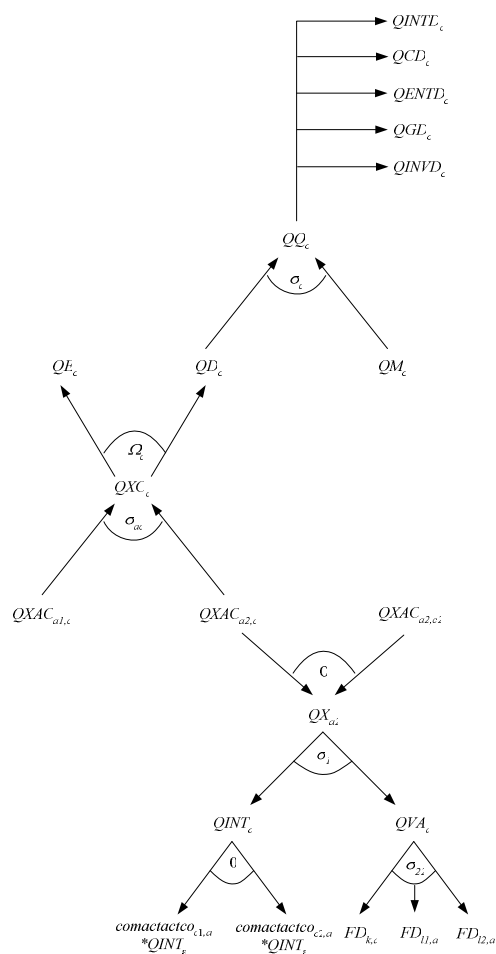

Production relationships by activities are defined by a series of nested Constant Elasticity of Substitution (CES) production functions. The nesting structure is illustrated in the lower part of Figure 3, where, for illustration purposes only, two intermediate inputs and three primary inputs ( $FD_{k,a}$ ,  $FD_{1,a}$  and  $FD_{2,a}$ ) are identified. Activity output is a CES aggregate of the quantities of aggregate intermediate inputs ( $QINT_a$ ) and value added ( $QVA_a$ ), while aggregate intermediate inputs are a Leontief aggregate of the (individual) intermediate inputs and aggregate value added is a CES aggregate of the quantities of primary inputs demanded by each activity ( $FD_{f,a}$ ). The allocation of the finite supplies of factors ( $FS_f$ ) between competing activities depends upon relative factor prices via first order conditions for optima. While the base model contains the assumption that all factors are fully employed and mobile this assumption can be relaxed.

#### 4.2. Data (Social Accounting Matrix)

The benchmark data are arranged in the form of a social accounting matrix (SAM), which is a system of accounts recording all transactions between agents in the economy. The SAM used for this paper is a 250 account aggregation of the PROVIDE SAM for South Africa in 2000

(See PROVIDE 2006 for a full description of the South Africa SAM database), with special attention given to accounts relating to the Eastern Cape. The SAM has 14 agricultural commodities, 16 non-agricultural commodities, 70 agricultural activities, 16 non-agricultural activities, 60 factors (including capital (GOS), 9 land and 50 labour factors) and 54 households. There are also accounts for enterprise, government, capital, stock changes and the rest of the world. A full listing of the accounts is provided in Appendix A.

The treatment of activities, specifically agricultural activities, is of importance in the SAM. The SAM uses a supply and use structure that allows for the possibility that activities can produce multiple products, which is the case for all activities in this SAM. In other words, each agricultural activity can produce a range of commodities, which is consistent with the fact that farms are typically multi-product firms. Agricultural activities are defined according to magisterial districts within the provinces. Land, labour factors and households are disaggregated according to provinces. In addition, labour factors are distinguished according to race and the level of skills; and households are distinguished according to race, level of education of the head of household and whether the household resides in one of the former homelands.

## 5. Policy scenario's

### 5.1. Scenario's

According to the Land Tax Sub-Committee (1998) the return to agricultural land is between 4% and 5% and therefore recommended a rate not exceeding 4%, because then the incentive to own land is taxed away. The Sub-Committee proposed in its Media statement no.15 a property rate of between 1% and 2% of the value of land. A rate lower than 1% may not justify the administrative burden placed on the tax authority, while a rate higher than 2% will tax away the economic returns to holding agricultural land. McDonald and Punt (2003) found the return on agricultural land in the Western Cape to average around 2% and therefore argue that a rate exceeding 2% will tax away the economic returns to holding agricultural land in the Western Cape. Agri SA (2003) estimates the rental rate of return to land to average around 5%, which is arguably high by international standards.

The data used for this study indicate that the Western Cape has the lowest average rate of return to land, estimated at 3%<sup>7</sup>. This means that a property rate on agricultural land exceeding 3% will result in negative income flowing to owners of land in the Western Cape. For this reason is 3% the maximum property rate simulated. Property rates are levied on all

---

<sup>7</sup> The rate of return to land is calculated as the disposable income of land factors divided by the value of land.

agricultural land in South Africa and increase from 0% to 3%, in 0.5 percentage point increments.

## 5.2. Closure rules

The model closure rules were selected with the objective of providing a realistic representation of the South African economy.

The *foreign exchange market* is assumed to clear via a flexible exchange rate and therefore the external balance (or current account balance) remains fixed. Since South Africa is a small country it is a price taker on international markets, i.e., all prices of imported and exported goods are fixed in foreign currency units.

The *capital account*, which records all savings and investment related transactions, is closed by assuming that the share of investment expenditure in total final domestic demand remains constant. This allows for some variation in the volume of investment due to changes in the prices of investment goods and from any change in the total value of domestic absorption. The equilibrating variables are the savings rates of all households and incorporated business enterprises. These rates are allowed to vary equi-proportionately, which ensures that savings equal investments in the economy.

The *factor market* closure involves different treatments for different factors. Land is assumed fully employed, fixed and immobile. Labour is divided into ‘semi- and unskilled’ and skilled labour for all racial groups, based on the occupation of workers<sup>8</sup>. The supply of semi- and unskilled African, Asian and Coloured labour is assumed to be perfectly elastic, based on the assumption that there is excess capacity (unemployment) of this labour in the economy. Activities can increase employment of these workers provided they are willing to pay the constant wage. Semi- and unskilled White labour, and skilled labour of all racial groups are assumed fixed, fully employed and mobile.

The assumptions for physical capital distinguish between a short-run and a long-run approach. Over the short term, physical capital is assumed fixed, fully employed and immobile, meaning that the quantity of capital used by each activity is fixed; forcing industry-specific returns to capital to adjust. Over the long term however, physical capital is mobile across sectors (activities) in the economy, leading to another round of adjustments in employment.

Four different closures are explored for the *government account*:

---

<sup>8</sup> See Appendix B for classification of occupations into skill level categories.

- “Inert”: An “inert” policy response is assumed – tax rates and the volume of government consumption are left unchanged, leaving government savings (the fiscal deficit) to vary to reach fiscal balance.
- “Active”: The government deficit is fixed and the volume of government consumption is allowed to increase to absorb the additional government revenue.
- “Neutral”: Government consumption and savings are held fixed while income tax rates for enterprises and households are allowed to change equi-proportionately.
- “Stax”: This closure rule is similar to the “neutral” closure, except that sales tax rates on commodities are allowed to vary equi-proportionately instead of income tax rates.

The “neutral” and “Stax” closures are referred to as the tax replacement closure rules. It should be noted that, though local municipalities receive the revenue from property rates, the model used for this study does not simulate different tiers of government.

Finally, the CPI is fixed to provide the model *numéraire*, that is, price changes are not absolute changes but have to be interpreted relative to the CPI.

In summary, eight different closures were investigated for each property rate change:

- “ST\_inert” and “LT\_inert”;
- “ST\_active” and “LT\_active”;
- “ST\_Stax” and “LT\_Stax”;
- “ST\_neutral” and “LT\_neutral”.

## 6. Model results

The “active closure” where government consumption increases is the most likely outcome of property rates, especially over the short-term, and therefore the discussion focuses on this closure. Thereafter the results with the “neutral” and “Stax” closure rules are discussed to investigate the extent of the impact in the event of a reduction in an alternative tax rate. The results for the “inert” closure are similar to that of the “neutral” closure and were used for sensitivity analysis. In addition, the results presented focus on the long-term closure rules, as the results from the short-term closures are used mainly to obtain an indication of the re-allocation of factors.

## 6.1. Results relating to increased government expenditure (“active” closure rule)

This section starts by discussing the macroeconomic impact of introducing property rates on the value of land in the event of an increase in government expenditure. Thereafter the direct impact of property rates on the factor income to land as well as the impact on the incomes of other factors is discussed, with reference to changes in wages and employment. Section 6.1.3 discusses the impact on the welfare of households. This is followed by a look at the impact of property rates on the consumer prices of selected commodities, followed by the effect on agricultural production output.

### 6.1.1. *Impact on selected macroeconomic indicators*

Introducing property rates on agricultural land will result in an effective redistribution of wealth as the after tax income from land (to the owner) will be lower. However, the impact on the economy is expected to be small, because income from land contributes less than 0.5% to the total income of households and property rates do not directly influence prices, suggesting no major shifts in resource allocation and production.

Introducing the highest property rate on land under consideration, 3%, will increase government revenue by R2 063 million. If government spends this additional revenue, the impact on the exchange rate, investment and gross domestic product (GDP) will be limited, as they will decline by less than 0.004%. The impact on exports and imports is larger, though still small. Exports will decline by 0.08% and imports by 0.07%. The decline in the value of imports is due to a fall in household income (fall in demand) and the decline in the value of exports is due to lower production output by all activities except that of services. Figure 4 shows these effects on the selected macroeconomic variables.

**Figure 4: Impact on selected macroeconomic variables when government spends the additional revenue, at a 3% property rate on the value of land**

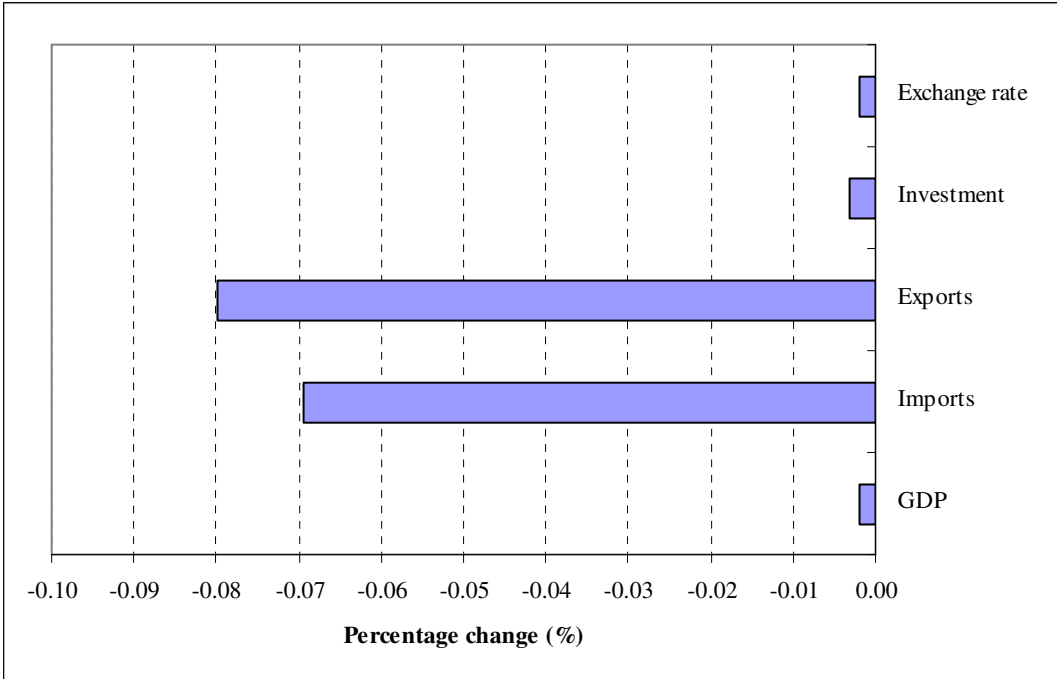

6.1.2. *Impact on incomes of factors*

Introducing property rates on the value of agricultural land will reduce the after tax income earned from agricultural land; this will have no effect on the rate of return to land as a productive asset, but it does lower the rate of return to land for the owner. Figure 5 shows that introducing a 0.5% property rate on the value of land will lead to income earned from land ownership falling by 12% in the Eastern Cape, and as the rate is increased to 3% income earned from land ownership will fall by 74%. The results show that the lower the initial rate of return to land, the greater is the impact of property rates on the after tax income from land. Figure 5 also shows that income to land changes near linearly as the property rates are increased. This is true for all results and therefore the remainder of the paper focuses on the 3% property rate simulation.



**Figure 5: Effect on income of land in the Eastern Cape (YFDISP) when government spends the additional revenue**

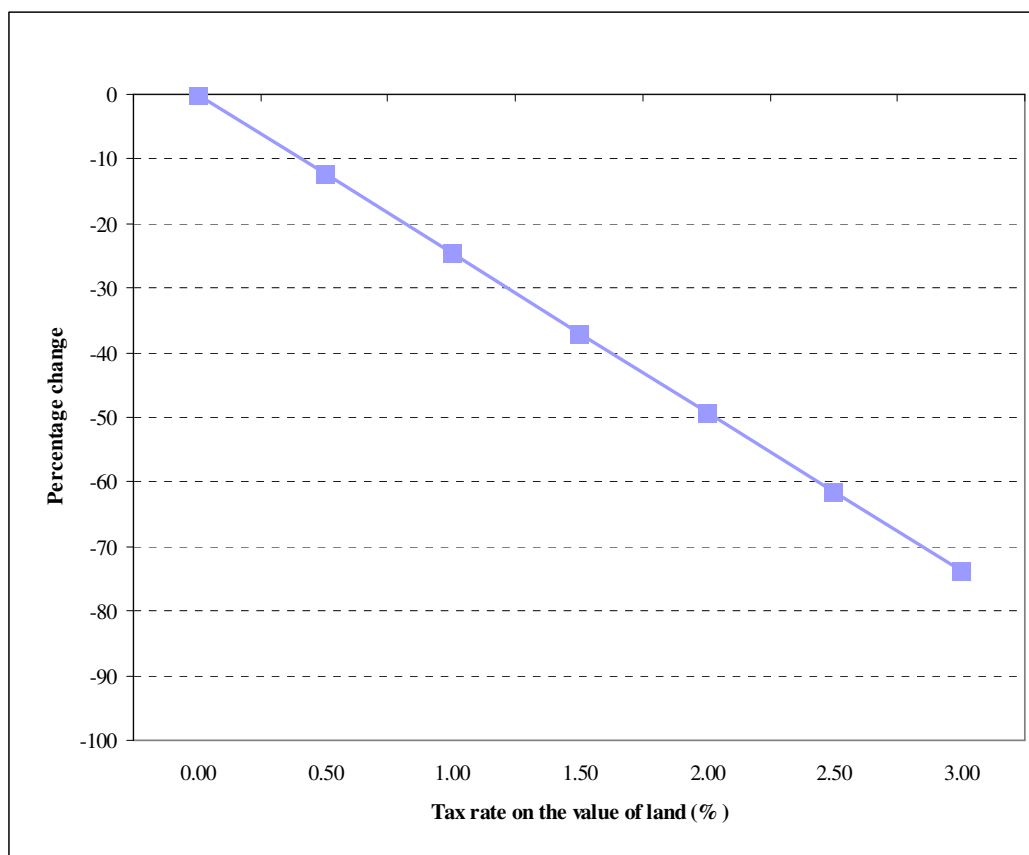

Though the rates are levied only on agricultural land, it will affect the entire economy (and all households) through forward and backward linkages. All representative households earn some income from agricultural land directly or indirectly; hence, the incomes of all households are affected negatively by the decline in income from land. Though introducing property rates has no direct impact on prices, there are small secondary effects. Changes in the incomes of households result in changes in demand, which lead to small changes in prices and thereby production. Price changes affect wages and employment via the price formation system and this again affects factor incomes and incomes of households. In addition, changes in the prices of commodities lead to changes in real consumption expenditures of households.

Figure 6 shows the impact on the incomes of capital and labour for a 3% property rate on the value of land. The impact on the incomes is small, not exceeding 0.06%. Asian and Coloured semi- and unskilled workers in the Eastern Cape are worst affected as over 24% of these workers are employed in the agricultural sector. Skilled workers experience some increases in their incomes, though small. Income to capital declines by 0.014%.

**Figure 6: Changes in incomes of capital and labour factors in the Eastern Cape (YF) when government spends the additional revenue, at a 3% property rate on the value of land**

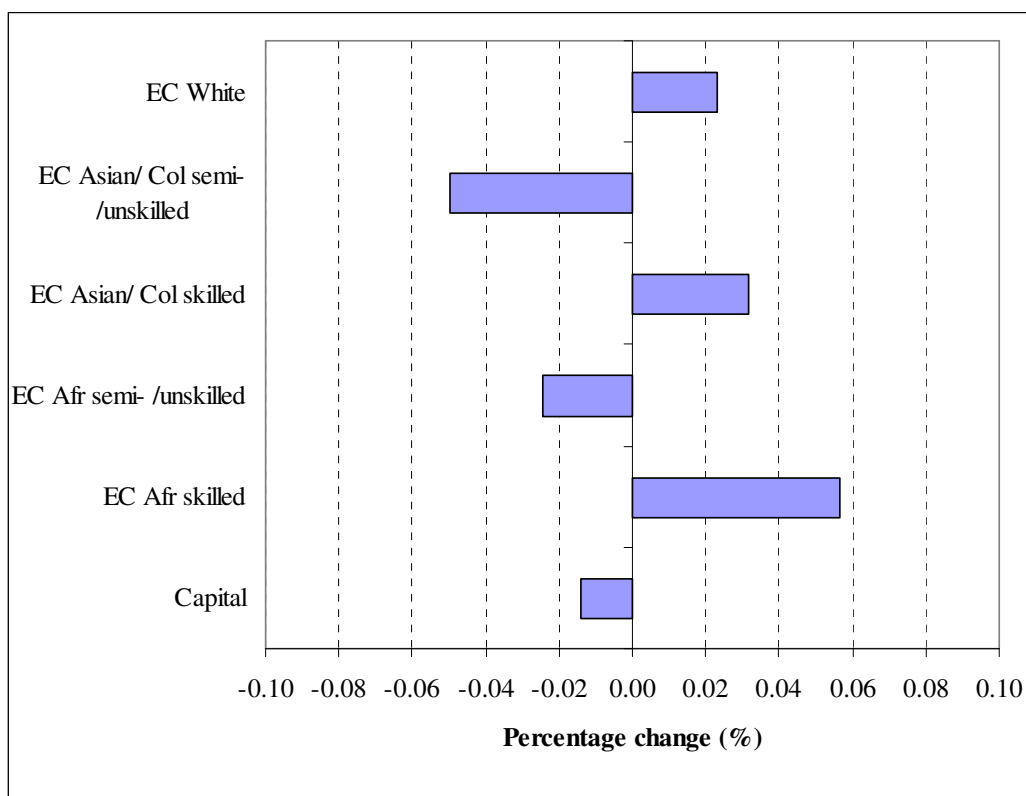

Changes in factor incomes of labour are determined by changes in the wage rates for fully employed factors and changes in employment for underemployed factors. Hence, the increase in the incomes of skilled labour implies that the wage rates of these labour categories increase; whereas the declines in the incomes of semi- and unskilled African, Asian and Coloured labour imply that unemployment increases among these labour types.

Table 2 shows the extent of the number of job losses in the economy. A 3% property rate on the value of land will result in 2 696 job losses of which more than half will be in the agricultural sector. The number of job losses in the Eastern Cape amount to 238.

**Table 2: Changes in the number of employment opportunities when government spends the additional revenue, at a 3% property rate on the value of land**

South Africa	-2,696
Number of job losses in agriculture	-1,436
Job losses in the EC	-238
Job losses in EC agriculture	-199

### 6.1.3. *Impact on the welfare of households*

Changes in incomes of factors, including land, capital and labour, largely explain the changes in the welfare of households, measured by real consumption expenditure of households<sup>9</sup>. Income from labour is the primary source of household incomes, followed by income from capital and land. Land contributes a very small share to household income, 0.45%, but some households receive up to 2% of their income from land. Despite the small contribution income from land makes to total household income, the large fall in the income to land as well as the lower income to capital dominates the increase in the incomes of some labour categories; leading to the real consumption expenditure of all representative households (urban and rural households) declining in the Eastern Cape (see Figure 7). There is a high correlation between the share of income from land in total household income and the change in household income: those households receiving a larger share of their total income from land will lose out most. For example, African agricultural households receive the largest share of their total income from land (0.9%), explaining the relatively large decline in their real consumption expenditure.

The total loss to household welfare in the Eastern Cape amounts to R145 million (0.30%), whereas the overall loss of welfare to South African households equals R1 625 million (0.30%). Almost all households will be worse off, with the exception of three representative households residing in Gauteng that will gain marginally. Introducing property rates on agricultural land will have a progressive impact on real household consumption expenditure, but, considering the small amount that is redistributed from a small number of households to the rest of the population, the redistributive impact will be marginal.

---

<sup>9</sup> It should be noted that real consumption expenditure as a measure of welfare does not capture the benefits of savings. The savings rate of households increases by 0.13%.

**Figure 7: Changes in real consumption expenditure of households when government spends the additional revenue, at a 3% property rate on the value of land**

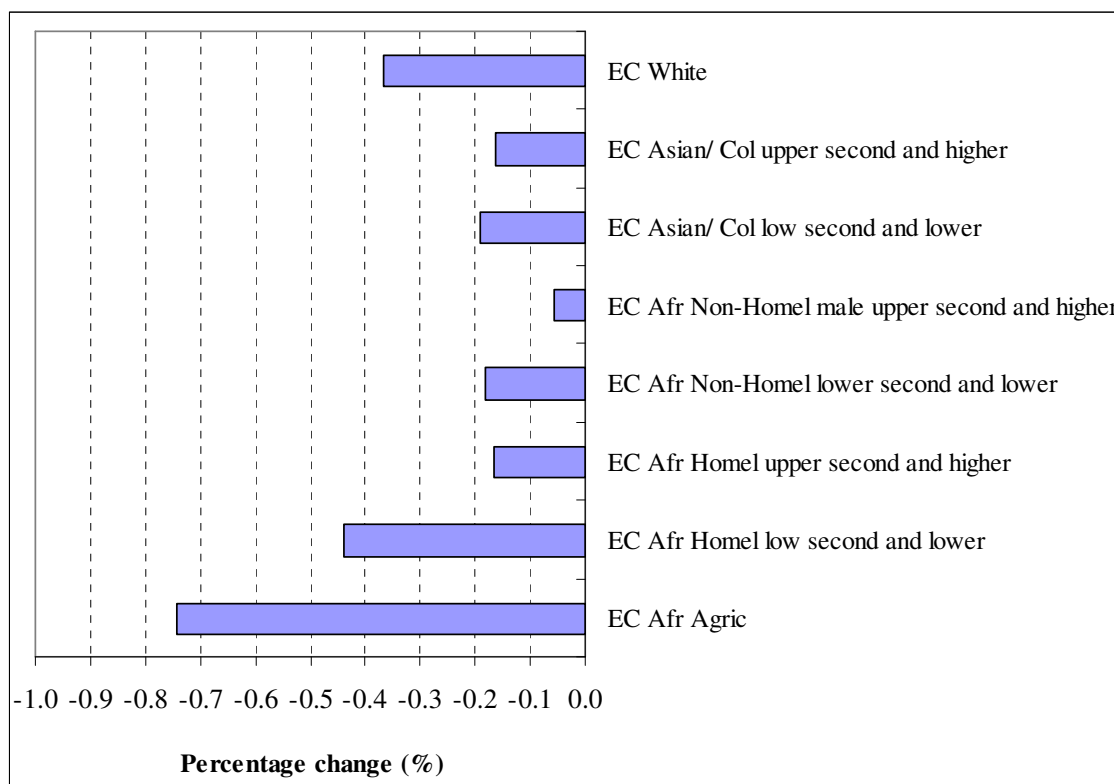

6.1.4. *Impact on prices*

As mentioned before, introducing property rates on agricultural land while government spends the additional revenue does not directly influence prices, but the changes in prices are the result of secondary effects in the economy. The small impact of property rates on the incomes of households and the limited redistributive effect thereof results in small shifts in demand, which lead to small changes in prices as shown in Figure 8. The agricultural commodities presented in Figure 8 are the most important commodities produced by the agricultural sectors in the Eastern Cape, while the other commodities account for over 80% of total household consumption. “Other agriculture” includes animal fibres, wild flowers, compost and firewood.

**Figure 8: Changes in the consumer prices (PQD) of selected commodities when government spends the addition revenue, at a 3% property rate on the value of land**

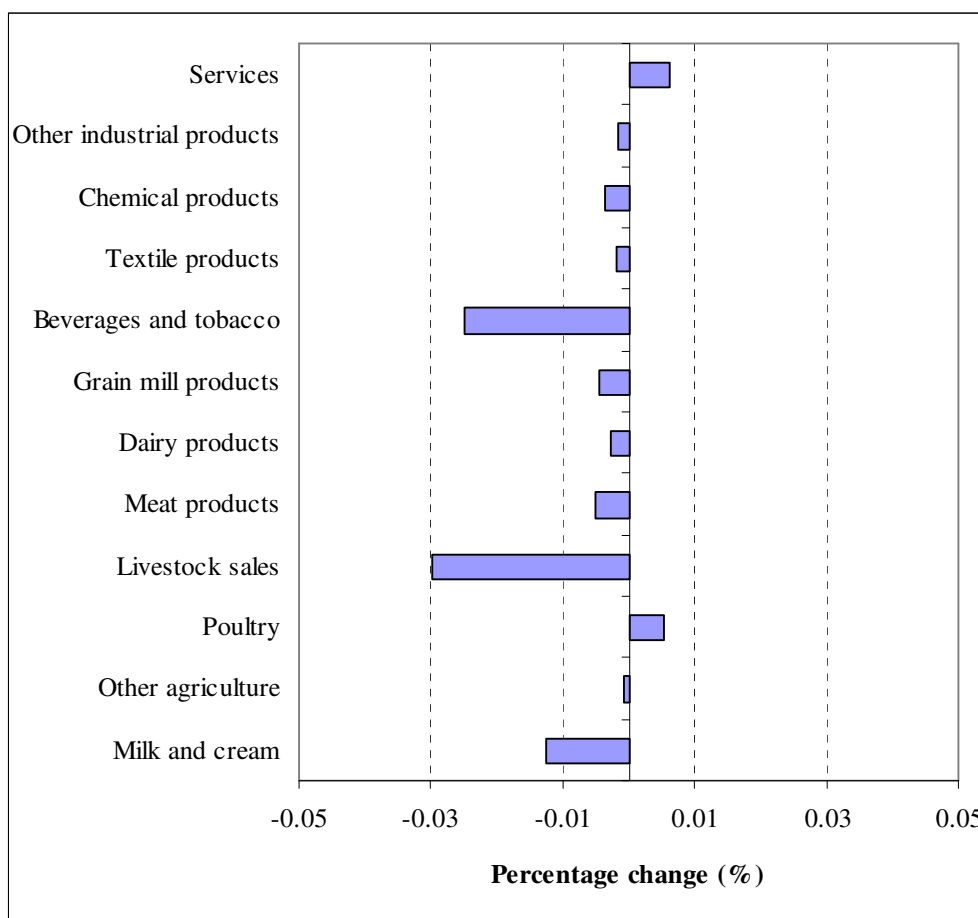

6.1.5. *Impact on agricultural output*

Since rating agricultural land has no significant influence on the redistribution of wealth or on prices, there will be no major shifts in production or the allocation of resources. The small changes in the prices of value added of agricultural activities in the Eastern Cape (they decline by less than 0.03%) confirm that there is little incentive to relocate factors of production to other production activities. This is also reflected in the small decline in domestic production of the main agricultural commodities produced in the Eastern Cape as shown in Figure 9.

**Figure 9: Changes in the domestic production (QXC) when government spends the additional revenue, at a 3% property rate on the value of land**

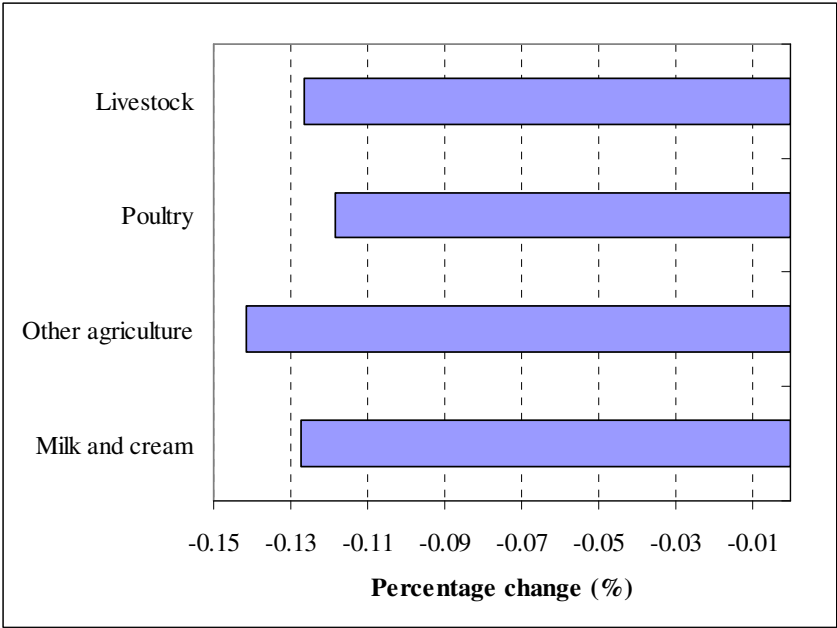

6.2. Results relating to the tax replacements (“neutral” and “Stax” closures)

From section 6.1.3, it is evident that introducing a 3% property rate on land with government spending the additional revenue will have a limited redistributive impact on the welfare of households as prices are not affected directly and the relocation of resources is limited. There is however a small negative impact on the welfare of almost all representative households. Government has the option of allowing compensating reductions in other tax rates to ameliorate or prevent the negative impact on household welfare while achieving some redistribution. Two alternative tax replacement measures were investigated: income taxes on households and enterprises were reduced proportionately under the “neutral” closure and sales taxes were reduced proportionately under the “Stax” closure.

6.2.1. *Macroeconomic impact*

Under the “neutral” closure, income is transferred from the landowners to the income taxpayer, with the higher income households receiving the largest reductions in their tax rates as the rates are reduced equi-proportionately. Since income from land accrues primarily to higher income households, the redistributive effect on income and the resulting changes in demand patterns will be limited. The very small impact on the economy of allowing a compensating reduction in income taxes is clearly shown in Figure 10. Levying a 3% property rate on the value of land has no effect on gross domestic product (GDP) and a marginal impact on the value of imports and exports, investment and the exchange rate (less than 0.02%).

The impact on the economy is expected to be larger when sales taxes are reduced (“Stax”), as these influence price formation directly, leading to changes in production activities. (Under the “neutral” closure, prices merely respond to small changes in consumption patterns, following the limited redistribution of income.) Under the “Stax” closure, income is redistributed from the landowners to all consumers (via lower sales taxes), leading to a shift in demand. The changes in the macroeconomic variables are larger under closure “LT\_Stax”, but still small as GDP increases by only 0.03%, investment by 0.07%, exports by 0.1%, imports by 0.1% and the exchange rate depreciates by 0.12%.

**Figure 10: Impact on selected macroeconomic indicators for the tax replacement closures, at a 3% property rate on the value of land**

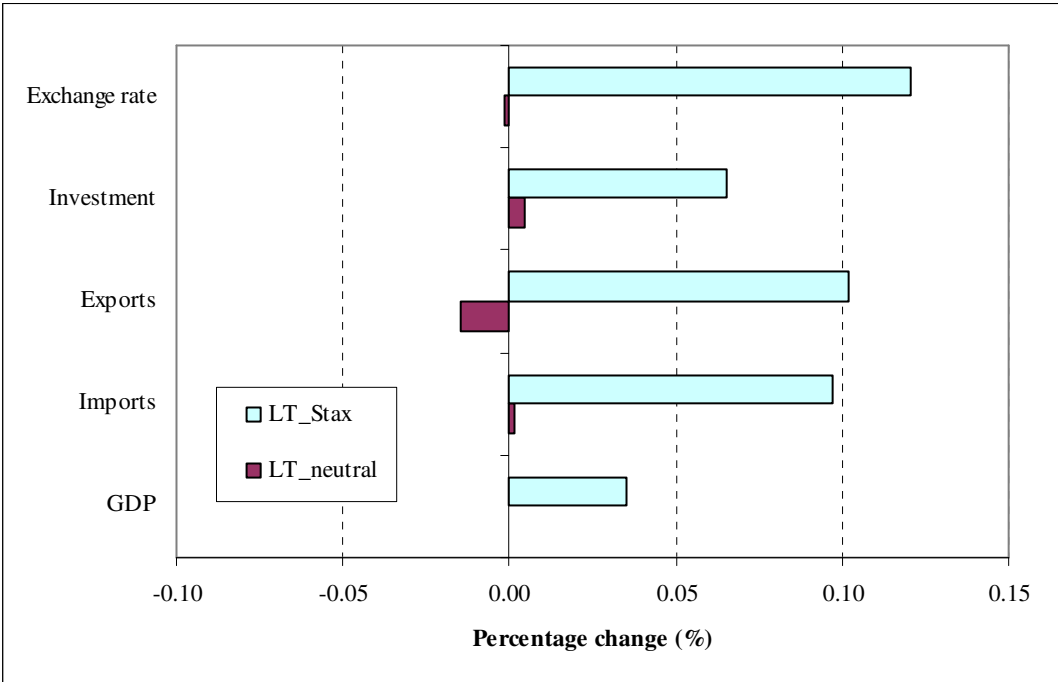

6.2.2. *Impact on incomes of factors*

Introducing a 3% property rate on the value of land will result in a 74% decline in income earned from agricultural land ownership in the Eastern Cape, irrespective of the closure rule under consideration.

Figure 11 shows the changes in the factor incomes of labour and capital under the different tax replacement closures. Allowing a compensating reduction in income taxes has a very small impact on the incomes of factors. Considering this small effect on incomes and the insignificant effect on the economy, the rest of the discussion focuses on a compensating reduction in sales taxes.

**Figure 11: Changes in the incomes of labour factors and capital for the tax replacement closures, at a 3% property rate on the value of land**

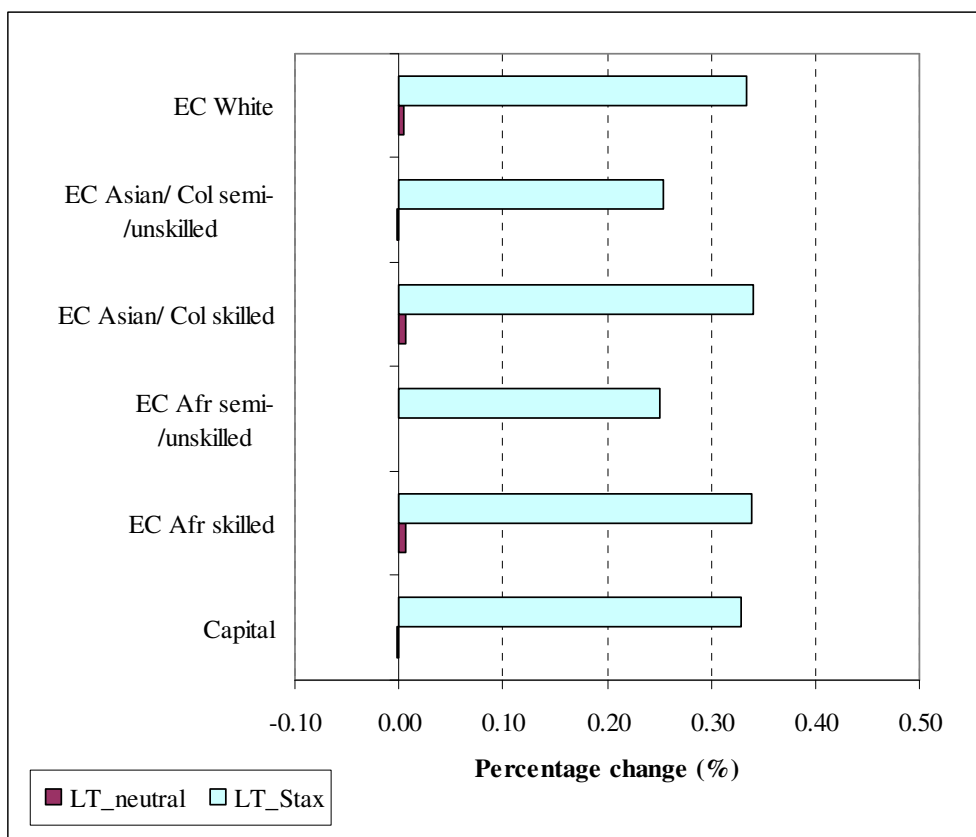

Allowing a compensating reduction in sales taxes, leads to increases in the incomes of factors by between 0.25% and 0.34%. The relatively larger increases are because reducing sales taxes allows the supply price of commodities to increase and this increase in the supply price feeds down through the price formation system to higher wages and employment. Table 3 shows that a reduction in sales taxes will result in the creation of over 18 000 new employment opportunities, of which 1 755 will be in the Eastern Cape. Only 89 of these additional employment opportunities will be in the agricultural sectors of the Eastern Cape.

**Table 3: Changes in the number of employment opportunities when allowing a compensating reduction in sales taxes, at a 3% property rate on the value of land**

<b>South Africa</b>	18,838
<b>Agricultural sector in South Africa</b>	1,752
<b>Eastern Cape</b>	1,755
<b>Agricultural sector in the Eastern Cape</b>	89

### 6.2.3. Impact on welfare of households

Changes in the welfare of households are explained largely by changes in factor incomes, as well as changes in prices. One would expect the incomes of households to increase under



closure “LT\_Stax” (considering the increases in wages and employment), but the large decline in the income to land dominates the changes in the welfare of those households receiving the largest share of income from land. Figure 12 shows that most representative households in the Eastern Cape gain when sales taxes are reduced, with the exception of African agricultural households and African households residing in the former homeland areas of which the household head has lower secondary or lower education. The changes in the welfare of households are small, ranging between -0.4% and 0.3%.

**Figure 12: Changes in real consumption expenditure of households when allowing a compensating reduction in sales taxes, at a 3% property rate on the value of land**

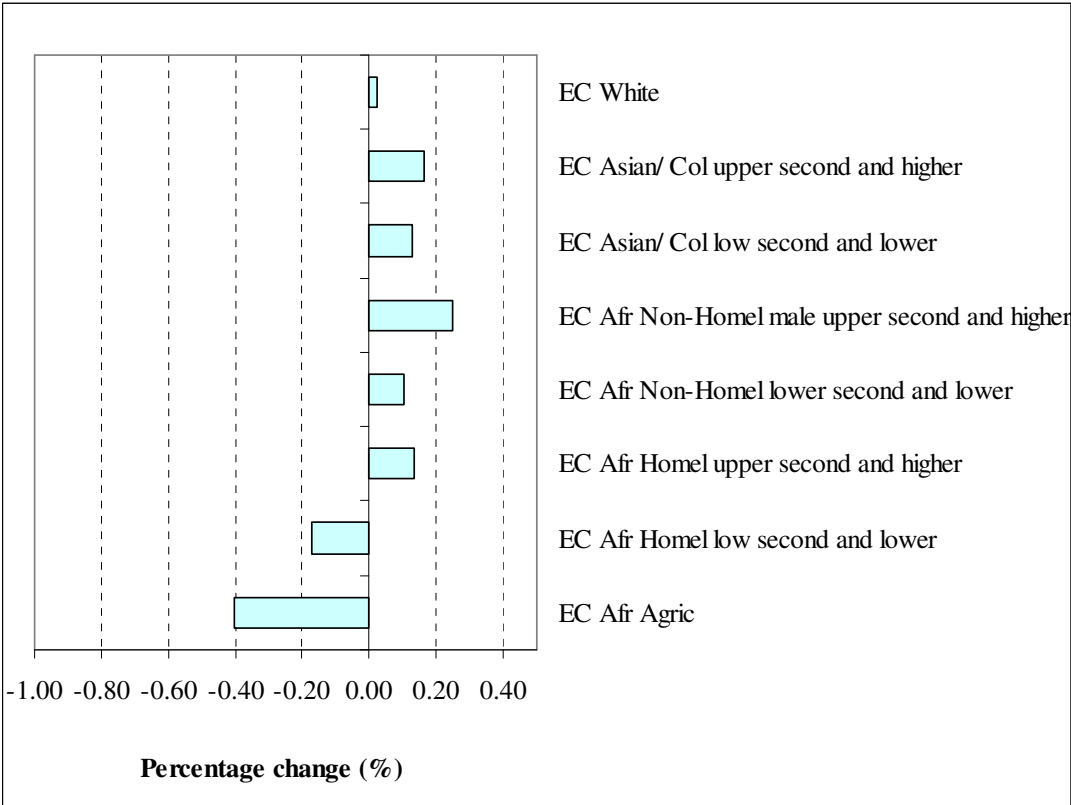

Overall households in South Africa will be better off in the event of a compensating reduction in sales taxes as real consumption expenditure will increase by R329 million (0.06%). The total welfare of households in the Eastern Cape will increase by R9 million (0.02%) in terms of real consumption expenditure; households in Gauteng and KwaZulu-Natal will also experience an increase in their overall welfare. However, in total, households in the Free State, Northern Cape, Limpopo, Mpumulanga, Western Cape and North West will lose out.

The distributional impact of a compensating reduction in sales taxes is similar to that of an increase in government expenditure, but the negative impact on households is much smaller.

Not surprisingly, a reduction in income taxes has a close to neutral distributional incidence on real consumption expenditure.

6.2.4. *Impact on prices*

Reducing sales taxes directly influences price formation. Figure 13 shows that, in general, the prices of those commodities on which the highest sales tax rates are levied decrease, while the prices of other commodities increase to keep constant the CPI. The exception is milk and cream, where the price decrease may be due to an increase in production of milk and cream (see Figure 14).

**Figure 13: Changes in the prices of selected commodities (PQD) when allowing a compensating reduction in sales taxes, at a 3% property rate on the value of land**

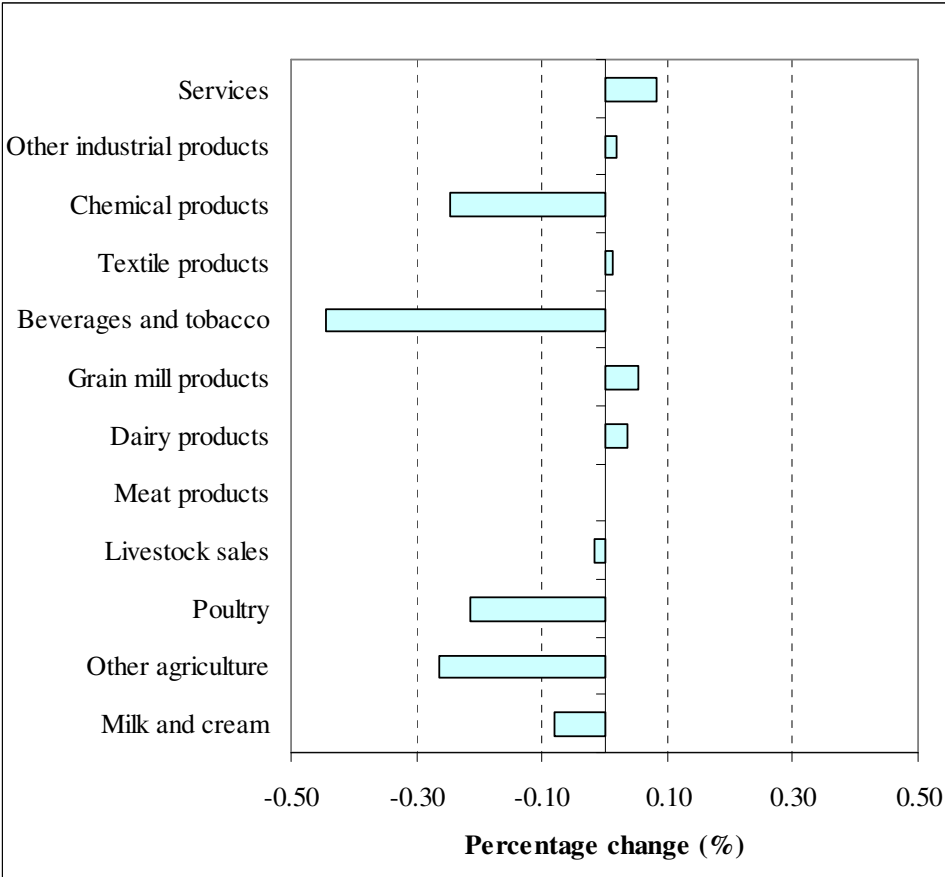

6.2.5. *Impact on agricultural output*

The changes in prices are small, not exceeding half a percent; hence, no major shifts in resource allocation will take place. Moreover, the prices of value added of all agricultural production activities increase by between 0.15% and 0.32%; these changes are small and within a narrow band, confirming that no major production shifts or reallocation of factors of

production will take place. The production output of livestock, poultry, “other agriculture” and milk and cream will increase slightly as shown in Figure 14.

**Figure 14: Changes in agricultural output (QXC) when allowing a compensating reduction in sales taxes, at a 3% property rate on the value of land**

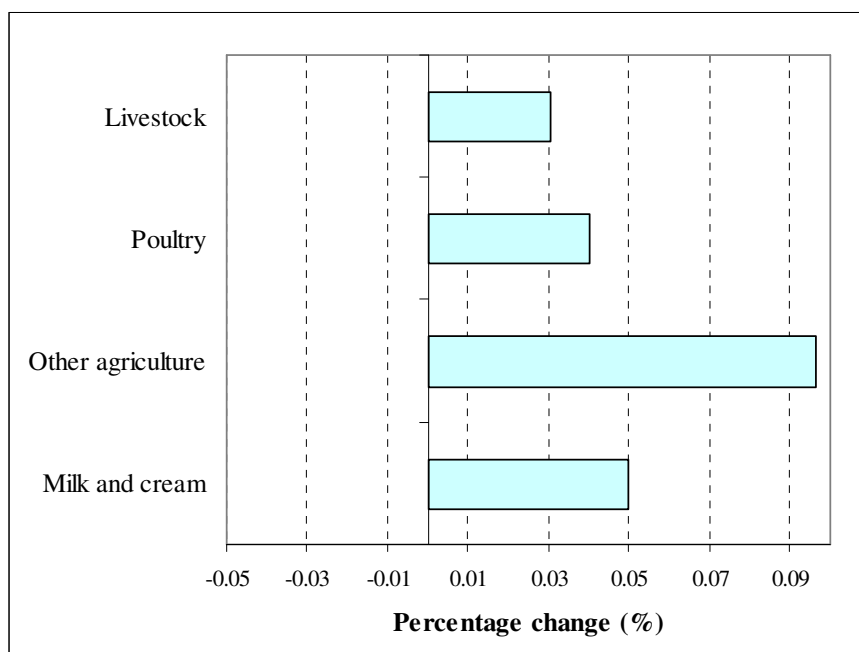

## 7. Conclusion

The Local Government: Municipal Property Rates Act (2004) came into effect on 1 July 2005 and states that all property owners, including commercial, residential, agriculture, government and public services infrastructure, are liable for the payment of rates. This study is an investigation into the socio-economic impact of levying annual property rates at 3% on the value of agricultural land, using a computable general equilibrium model.

The results show that the impact of property rates on the economy depends on the use made of the additional revenue by government. Levying a 3% property rate on the value of agricultural land will have a small impact on the macro-economy when government spends the additional revenue of R2 063 million. Total welfare of households, measured by real consumption expenditure, will decrease by R1 625 million (0.30%) and real expenditure of households in the Eastern Cape will decline by R145 million (0.30%); all representative households in this province will be worse off.

The changes in the welfare of households are driven largely by changes in the incomes of factors, including labour, capital and land. Though land contributes less than 0.5% to the total income of households in South Africa, the large negative impact on the income of land

dominates the changes in the incomes of households. The primary recipients of income from land lose out most as well as those households who are dependent on land for a relatively large share of their income. Increasing the factor tax has a marginal progressive impact on real consumption expenditures of households, but the amount redistributed is so small that the shifts in demand patterns are negligible and therefore the changes the prices of commodities are only marginal.

Introducing property rates on agricultural land does not influence prices directly, but it is only the small redistributive impact that results in small secondary price effects; therefore the effects on prices, production output and the allocation of resources are limited. Agricultural activities in the Eastern Cape will contract marginally and the production output of livestock, poultry, milk and cream, and “other agriculture” (animal fibres, wild flower, compost and firewood) will decline by between 0.11% and 0.15%. The number of job losses is estimated at 2 696 of which 1 436 will be in the agricultural sector. The number of job losses in the Eastern Cape is estimated at 238.

Instead of spending the additional revenue, government may lower another tax instrument such as sales taxes or income taxes. In the event of allowing a compensating reduction in income taxes, income is transferred from the landowners to the income taxpayer, with the higher income households receiving the largest reductions in their tax rates as the rates are reduced equi-proportionately. However, income from land accrues primarily to higher income households and therefore the redistributive impact is close to neutral. Since there is virtually no distributional impact and since property rates do not directly influence prices, the effect on the economy is very small.

The impact on the economy is bigger, though still small, in the case of a compensating reduction in sales taxes *vis-à-vis* a reduction in income taxes. Lowering sales taxes equi-proportionately directly influences the prices of commodities, leading to changes in wages and employment. This influences household welfare in two ways: changes in employment and wages result in changes in factor and household incomes, and changes in the prices of commodities result in changes in real consumption expenditure of households. The results indicate that allowing a compensating reduction in sales taxes has a progressive impact on household welfare, similar to the redistributive impact in the event of increased government expenditure; however, lowering sales taxes results in an increase in household welfare as total real consumption expenditure of households increases by R329 million (0.06%). Real consumption expenditure of households in the Eastern Cape increases by R9 million, (0.02%), but some representative households are worse off. A compensating reduction in sales taxes will result in 18 838 additional employment opportunities of which 1 755 will be in the Eastern Cape.

## 8. References

- Ackron, J and Vink, N (2004). Property Rating of Agricultural Land in the Western Cape. Towards a Guideline Framework. A Report to Western Cape Provincial Government.
- Agri SA. (2003). Local Government: Property Rates Bill. Submission to the Provincial and Local Government Portfolio Committee, 15 May 2003. Available [online]: <http://www.pmg.org.za>
- Armington, P.S. (1969). "A theory of demand for products distinguished by place of production". IMF Staff papers, Vol. 16.
- Department: Provincial and Local Government. (2004a). Local Government: Municipal Property Rates Act, No.6 of 2004. Available [online]: <http://www.dplg.org.za>
- Department: Provincial and Local Government. (2004b). Local Government: Municipal Property Rates Act, No.6 of 2004. Available: <http://www.dplg.org.za>
- Dervis, K., De Melo, J. and Robinson, S. (1982). "General Equilibrium Models for Development Policy". New York, Cambridge University Press.
- Devarajan, S., Lewis, J.D. and Robinson, S. (1994). "Getting the Model Right: The General Equilibrium Approach to Adjustment Policy". Mimeo.
- Kilkenny, M. (1991). "Computable General Equilibrium Modelling of Agricultural Policies: Documentation of the 30-Sector FPGE GAMS Model of the United States", USDA ERS Staff Report AGES 9125.
- Land Tax Sub-Committee (1995). Interim Report of the Land Tax Sub-Committee of the Commission of Inquiry into Certain Aspects of the Tax Structure of South Africa (Katz Commission). October 1995.
- Land Tax Sub-Committee (1998). Finale Report of the Land Tax Sub-Committee of the Commission of Inquiry into Certain Aspects of the Tax Structure of South Africa (Katz Commission).
- McDonald, S and Punt, C (2004). Some Welfare Implications of a Land Tax on the Western Cape. South African Journal of Economics 72(4): 808-833.
- PE Technikon. (2004). "An Investigation into the Possible Effect that the Local Government Property Rates Bill may have on the Agricultural Sector in the Eastern Cape". Report prepared for Agri Eastern Cape by PE Technikon, Department of Agriculture and Game Ranch Management. 30 June 2004.
- PROVIDE (2006). "A Social Accounting Matrix for South Africa: 2000." PROVIDE Technical Paper Series. Forthcoming.
- PROVIDE (2005). "The PROVIDE Project Standard Computable General Equilibrium Model". PROVIDE Technical Paper Series 2005:3.
- Pyatt, G. (1998). "A SAM Approach to Modelling." Journal of Policy Modelling 10: 327-352.
- Robinson, S., Kilkenny, M. and Hanson, K. (1990). "USDA/ERS Computable General Equilibrium Model of the United States". USDA ERS Staff Report AGES 9049.
- Reynolds, S.H. (2005). "Property rates on agricultural land and improvements in the Western Cape". Western Cape Department of Agriculture, Elsenburg. Unpublished.

Van Schalkwyk, H.D., Louw, D.B. and Dannhauser, A.P. (1998). Research report on the introduction of a land tax in South Africa. Department of Agricultural Economics, University of the Free State.  
Unpublished.

## 9. Appendices

### 9.1. Appendix A: SAM Accounts

#### Commodities: Agriculture

1	Summer Cereals
2	Winter Cereals
3	Other Field Crops
4	Potatoes and Vegetables
5	Wine grapes
6	Citrus
7	Subtropical
8	Deciduous
9	Other Horticulture
10	Livestock Sales
11	Milk and Cream
12	Other agriculture
13	Poultry
14	Other Animals

#### Commodities: Other

15	Forestry and fishing
16	Mining
17	Meat products
18	Fish products
19	Fruit and vegetables products
20	Oils and fats products
21	Dairy products
22	Grain mill products
23	Confectionary products
24	Other food products
25	Beverages and tobacco
26	Textile products
27	Chemical products
28	Iron and steel products incl machinery
29	Other industrial
30	Services

#### Trade and transport margins

31	Trade margin
32	Transport margin

#### Activities: Agriculture

33	WC Cape Town
34	WC Boland
35	WC Overberg
36	WC Garden Route
37	WC Little Karoo
38	WC Breede River

39	WC Swartland
40	WC West Coast
41	WC Central Karoo
42	NC Namakwaland
43	NC Sutherland Karoo
44	NC Victoria West Karoo
45	NC De Aar Karoo
46	NC Kgalagadi
47	NC Carnavon Karoo
48	NC Frances Baard
49	NC Kimberley
50	NW Vryburg
51	NW Potchefstroom District
52	NW Klerksdorp
53	NW Rustenburg District
54	NW Marico
55	FS West Xhariep
56	FS Bloemfontein
57	FS East Xhariep
58	FS Goudveld
59	FS Bothaville District
60	FS Thabo Mofutsanyane
61	FS Southern Free State
62	FS Sasolburg
63	EC West Ukhahlamba
64	EC East Ukhahlamba
65	EC Chris Hani
66	EC Cacadu
67	EC East Londen
68	EC Middelburg District
69	EC Humansdorp District
70	EC Port Elizabeth District
71	EC Graaff Reinet District
72	EC Willowmore District
73	KZ Ethekewini
74	KZ Pietermaritzburg
75	KZ SE Umgundgundlovu
76	KZ Ugu
77	KZ Sisonke
78	KZ NW Umgundgundlovu
79	KZ Uthukela
80	KZ Amajuba
81	KZ Zululand
82	KZ Uthungulu
83	KZ Umkhanyakude
84	MP Mpumulanga East Rand

85	MP Witbank District	130	Western Cape African Semi- and unskilled
86	MP Groblersdal District	131	Western Cape Coloured and Asian Skilled
87	MP Govan Mbeki	132	Western Cape Coloured and Asian Semi- and unskilled
88	MP Nelspruit	133	Western Cape White High-skilled and skilled
89	MP Pilgrims Rest District	134	Western Cape White Semi- and Unskilled
90	LP Phalaborwa District	135	Eastern Cape African High-skilled and skilled
91	LP Soutpansberg District	136	Eastern Cape African Semi- and unskilled
92	LP Waterberg District	137	Eastern Cape Coloured and Asian High-skilled and Skilled
93	LP Bela Bela	138	Eastern Cape Coloured and Asian Semi- and Unskilled
94	LP Lebowa	139	Eastern Cape White
95	LP Polokwane District	140	Northern Cape African High-skilled and Skilled
96	GT Ekurhuleni	141	Northern Cape African Semi- and Unskilled
97	GT South Ekurhuleni	142	Northern Cape Coloured and Asian High-skilled and Skilled
98	GT West Rand	143	Northern Cape Coloured and Asian Semi- and Unskilled
99	GT Cullinan District	144	Northern Cape White
100	GT Sedibeng	145	Free State African High-skilled and Skilled
101	GT Tshwane	146	Free State African Semi- and unskilled
102	GT Johannesburg	147	Free State Coloured and Asian High-skilled and Skilled
		148	Free State Coloured and Asian Semi- and Unskilled
		149	Free State White
		150	Kwazulu-Natal African High-skilled and skilled
		151	Kwazulu-Natal African Semi- and Unskilled
		152	Kwazulu-Natal Coloured High-skilled and Skilled
		153	Kwazulu-Natal Coloured Semi- and Unskilled
		154	Kwazulu-Natal Asian High-skilled and Skilled
		155	Kwazulu-Natal Asian Semi- and Unskilled
		156	Kwazulu-Natal White High-skilled and Skilled
		157	Kwazulu-Natal White Semi- and Unskilled
		158	North West African High-skilled and Skilled
<b>Activities: Other</b>			
103	Forestry fishing		
104	Mining		
105	Meat		
106	Fish		
107	Fruit		
108	Oils		
109	Dairy		
110	Grain mills		
111	Confectionery		
112	Other food		
113	Beverages and tobacco		
114	Textiles		
115	Other Chemicals		
116	Iron and steel		
117	Other industrial		
118	Services		
<b>Factors: Capital</b>			
119	Gross operating surplus mixed income		
<b>Factors: Land</b>			
120	Western Cape Land		
121	Northern Cape Land		
122	North West Land		
123	Free State Land		
124	Eastern Cape Land		
125	KwaZulu-Natal Land		
126	Mpumalanga Land		
127	Limpopo Land		
128	Gauteng Land		
<b>Factors: Labour</b>			
129	Western Cape African High-skilled and Skilled		



159	North West African Semi- and unskilled	186	Eastern Cape African Homeland Lower Secondary and lower
160	North West Coloured and Asian High-skilled and Skilled	187	Eastern Cape African Homeland Upper Secondary and higher
161	North West Coloured and Asian Semi- and Unskilled	188	Eastern Cape African Non-Homeland Lower Secondary and lower
162	North West White	189	Eastern Cape African Non-Homeland Male Upper Secondary and higher
163	Gauteng African High-skilled and skilled	190	Eastern Cape Asian and Coloured Lower Secondary and lower
164	Gauteng African Semi- and Unskilled	191	Eastern Cape Asian and Coloured Upper Secondary and higher
165	Gauteng Asian and Coloured High-skilled and Skilled	192	EC White
166	Gauteng Asian and Coloured Semi- and Unskilled	193	Northern Cape African Primary and lower
167	Gauteng White High-skilled and skilled	194	Northern Cape African Lower Secondary and higher
168	Gauteng White Semi- and Unskilled	195	Northern Cape Coloured and Asian Lower Secondary and lower
169	Mpumalanga African High-skilled and skilled	196	Northern Cape Coloured and Asian Upper Secondary and higher
170	Mpumalanga African Semi- and Unskilled	197	Northern Cape White
171	Mpumalanga Coloured and Asian High-skilled and Skilled	198	Free State African Agricultural
172	Mpumalanga Coloured and Asian Semi- and Unskilled	199	Free State African Lower Secondary and lower
173	Mpumalanga White	200	Free State African Upper Secondary and higher
174	Limpopo African High-skilled and skilled	201	Free State Asian and Coloured
175	Limpopo African Semi-unskilled	202	FS White
176	Limpopo Coloured and Asian High-skilled and Skilled	203	Kwazulu-Natal African Agricultural
177	Limpopo Coloured and Asian Semi- and Unskilled	204	Kwazulu-Natal African Lower Secondary and lower
178	Limpopo White	205	Kwazulu-Natal African Upper Secondary and higher
<b>Households</b>		206	Kwazulu-Natal Asian Lower Secondary and lower
179	Western Cape African Lower Secondary and lower	207	Kwazulu-Natal Asian Upper Secondary and higher
180	Western Cape African Upper Secondary and higher	208	Kwazulu-Natal Coloured
181	Western Cape Asian and Coloured Lower Secondary and lower	209	Kwazulu-Natal White Lower Secondary and lower
182	Western Cape Asian and Coloured Upper Secondary and higher	210	Kwazulu-Natal White Upper Secondary and tertiary
183	Western Cape White Lower Secondary and lower	211	North West African Agricultural
184	WC White Upper Secondary and tertiary	212	North West African Lower Secondary and lower
185	Eastern Cape African Agricultural		

213	North West African Upper Secondary and higher and higher	<b>Tax accounts</b>	233	Import duties
214	North West Asian and Coloured		234	Export tax
215	North West White		235	Value added tax on imports
216	Gauteng African Agricultural		236	Value added tax on domestic go
217	Gauteng African Lower Secondary and lower		237	Excise duty
218	Gauteng African Upper Secondary and higher		238	Sales Tax
219	Gauteng Asian and Coloured Lower Secondary and lower		239	Sales subsidies
220	Gauteng Asian and Coloured Upper Secondary and higher		240	Production taxes
221	Gauteng White Lower Secondary and lower		241	Production refunds or VAT
222	Gauteng White Upper Secondary and tertiary		242	Production subsidies
223	Mpumalanga African Agricultural		243	Factor Tax
224	Mpumalanga African Lower Secondary and lower		244	Direct income taxes
225	Mpumalanga African Upper Secondary and higher	<b>Other accounts</b>	245	Central Government
226	Mpumalanga Asian and Coloured		246	Business Enterprises
227	Mpumalanga White		247	Savings
228	Limpopo African Agricultural		248	Stock Changes
229	Limpopo African Lower Secondary and lower		249	Rest of the World
230	Limpopo African Upper Secondary and higher		250	Account totals
231	Limpopo Asian and Coloured			
232	Limpopo White			

9.2. Appendix B: Classification of occupations into skill level categories

Factor code	Description	Skill classification
0	Not applicable/not working	Not applicable
1	Legislators, senior officials and managers	High skilled
2	Professionals	High skilled
3	Technical and associate professionals	High skilled
4	Clerks	Skilled
5	Service workers and shop and market sales workers	Skilled
6	Skilled agricultural and fishery workers	Semi-skilled
7	Craft and related trades workers	Semi-skilled
8	Plant and machine operators and assemblers	Semi-skilled
9	Elementary Occupation	Unskilled
10	Domestic workers	Unskilled
11*	Not adequately or elsewhere defined, unspecified	Unskilled

\*Code 11 may include semi-skilled, skilled and/or high skilled workers as well, but it is almost impossible to determine.

9.3. Appendix C: Percentage change in the welfare of households

	“LT_active”		“LT_neutral”		“LT_Stax”	
	Change Rmillions	% change	Change Rmillions	% change	Change Rmillions	% change
WC Afr Lower Sec and lower	-53.08	-1.03	-47.32	-0.92%	-35.58	-0.69%
WC Afr Upper Sec and higher	-13.42	-0.39	-2.85	-0.08%	-0.91	-0.03%
WC Asian/ Col Lower Sec and lower	-57.15	-0.30	-15.93	-0.08%	12.69	0.07%
WC Asian/ Coloured Upper Sec and higher	-44.39	-0.29	6.58	0.04%	12.07	0.08%
WC White Lower Sec and lower	-27.30	-0.70	-12.23	-0.31%	-10.21	-0.26%
WC White Upper Sec and tertiary	-284.16	-0.74	-59.79	-0.16%	-125.13	-0.33%
EC Afr Agric	-9.02	-0.74	-7.30	-0.60%	-4.86	-0.40%
EC Afr Homeland Lower Sec and lower	-52.86	-0.44	-39.51	-0.33%	-20.59	-0.17%
EC Afr Homeland Upper Sec and higher	-11.92	-0.17	5.52	0.08%	9.76	0.14%
EC Afr Non-Homeland Lower Sec and lower	-8.16	-0.18	-1.48	-0.03%	4.63	0.10%
EC Afr Non-Homeland Male Upper Sec and higher	-2.09	-0.06	9.19	0.25%	9.19	0.25%
EC Asian/ Coloured Lower Sec and lower	-5.37	-0.19	0.53	0.02%	3.69	0.13%
EC Asian/ Coloured Upper Sec and higher	-3.74	-0.16	4.25	0.18%	3.75	0.16%
EC White	-51.59	-0.37	32.97	0.23%	3.59	0.03%
NC Afr Primary and lower	-3.66	-0.47	-2.64	-0.34%	-1.68	-0.21%
NC Afr Lower Sec and higher	-4.90	-0.48	-2.35	-0.23%	-1.93	-0.19%
NC Asian/ Col Lower Sec	-10.06	-0.80	-8.26	-0.66%	-6.47	-0.52%

	“LT_active”		“LT_neutral”		“LT_Stax”	
	Change Rmillions	% change	Change Rmillions	% change	Change Rmillions	% change
and lower						
NC Asian/Col Upper Sec and higher	-2.39	-0.12	2.71	0.14%	3.29	0.17%
NC White	-140.98	-1.92	-100.95	-1.37%	-110.73	-1.51%
FS Afr Agric	-0.78	-0.24	-0.55	-0.17%	0.17	0.05%
FS Afr Lower Sec and lower	-11.75	-0.13	-0.33	0.00%	13.13	0.15%
FS Afr Upper Sec and higher	-10.01	-0.21	3.09	0.06%	4.89	0.10%
FS Asian/ Col	-2.81	-0.38	-1.75	-0.24%	-0.57	-0.08%
FS White	-143.81	-0.82	-63.09	-0.36%	-77.31	-0.44%
KZN Afr Agric	-8.36	-0.42	-5.86	-0.29%	-1.62	-0.08%
KZN Afr Lower Sec and lower	-44.33	-0.16	-13.60	-0.05%	40.15	0.15%
KZN Afr Upper Sec and higher	-18.78	-0.11	10.75	0.07%	34.81	0.21%
KZN Asian Lower Sec and lower	-7.98	-0.11	10.91	0.15%	18.94	0.26%
KZN Asian Upper Sec and higher	-11.51	-0.12	14.61	0.16%	23.49	0.25%
KZN Coloured	-0.29	-0.02	2.21	0.14%	5.18	0.33%
KZN White Lower Sec and lower	-2.11	-0.11	10.18	0.54%	6.79	0.36%
KZN White Upper Sec and tertiary	-79.90	-0.33	76.29	0.32%	25.27	0.10%
NW Afr Agric	-6.37	-0.77	-3.64	-0.44%	-2.82	-0.34%
NW Afr Lower Sec and lower	-31.41	-0.23	-14.18	-0.10%	9.11	0.07%
NW Afr Upper Secondary and higher	-9.73	-0.13	6.13	0.08%	16.52	0.22%
NW Asian/ Col	-1.17	-0.18	0.72	0.11%	0.85	0.13%
NW White	-76.21	-0.92	-29.74	-0.36%	-41.12	-0.50%
GT Afr Agric	0.25	0.02	0.82	0.08%	3.51	0.33%
GT Afr Lower Sec and lower	-2.13	0.00	61.20	0.13%	159.94	0.34%
GT Afr Upper Sec and higher	6.23	0.02	85.43	0.21%	135.94	0.33%
GT Asian/ Col Lower Sec and lower	0.20	0.01	7.04	0.18%	12.82	0.33%
GT Asian/ Col Upper Sec and higher	-1.81	-0.02	20.90	0.22%	29.44	0.32%
GT White Lower Sec and lower	-7.78	-0.08	29.70	0.31%	35.06	0.37%
GT White Upper Sec and tertiary	-13.29	-0.02	283.73	0.35%	293.90	0.37%
MP Afr Agric	-8.41	-1.24	-7.22	-1.07%	-6.20	-0.92%
MP Afr Lower Sec and lower	-113.38	-0.89	-91.25	-0.72%	-72.62	-0.57%
MP Afr Upper Sec and higher	-22.97	-0.46	-10.23	-0.20%	-6.55	-0.13%
MP Asian/ Col	-6.35	-0.71	-4.39	-0.49%	-2.90	-0.32%
MP White	-22.57	-0.36	4.30	0.07%	0.06	0.00%
LP Afr Agric	-3.97	-0.55	-3.57	-0.50%	-1.88	-0.26%
LP Afr Lower Sec and lower	-90.06	-0.52	-63.05	-0.37%	-34.33	-0.20%
LP Afr Upper Sec and higher	-32.59	-0.33	-13.21	-0.13%	-1.93	-0.02%
LP Asian/ Coloured	-2.86	-0.68	-2.10	-0.50%	-1.61	-0.38%
LP White	-50.16	-1.10	-30.28	-0.66%	-33.89	-0.74%

### **Working Papers in this Series**

<b>Number</b>	<b>Title</b>	<b>Date</b>
WP2004:1	Trade Liberalisation, Efficiency, and South Africa's Sugar Industry	July 2004
WP2004:2	The Welfare Impacts of Domestic and International Agricultural Efficiency Gains: A South African Case Study	December 2004
WP2005:1	The Impact of Oil Price Increases in the South African Economy	February 2005
WP2005:2	Costs and Benefits of Higher Tariffs on Wheat Imports – A General Equilibrium Analysis	April 2005
WP2005:3	Quantifying the economic divide in South African agriculture: An income-side analysis	September 2005
WP2005:4	The impact of a higher fuel levy on the Western Cape	November 2005
WP2005:5	General Equilibrium Effects in the South African Maize Market: International Trade Simulations	November 2005
WP2005:6	The welfare impacts of targeted transfers to poor households	December 2005
WP2006:1	The impact of increasing excise duties on the economy	March 2006
WP2006:2(1)	The impact of property rates on agricultural land, focusing on the Free State	March 2006
WP2006:2(2)	The impact of property rates on agricultural land, focusing on Limpopo	June 2006
WP2006:2(3)	The impact of property rates on agricultural land, focusing on the Western Cape	June 2006
WP2006:2(4)	The impact of property rates on agricultural land, focusing on the Northern Cape	June 2006
WP2006:2(5)	The impact of property rates on agricultural land, focusing on the Eastern Cape	June 2006
WP2006:2(6)	The impact of property rates on agricultural land, focusing on KwaZulu-Natal	June 2006
WP2006:2(7)	The impact of property rates on agricultural land, focusing on Mpumalanga	June 2006
WP2006:2(8)	The impact of property rates on agricultural land, focusing on North West	June 2006
WP2006:2(9)	The impact of property rates on agricultural land, focusing on Gauteng	June 2006

### **Other PROVIDE Publications**

Technical Paper Series  
Background Paper Series  
Research Reports