



AgEcon SEARCH
RESEARCH IN AGRICULTURAL & APPLIED ECONOMICS

The World's Largest Open Access Agricultural & Applied Economics Digital Library

This document is discoverable and free to researchers across the globe due to the work of AgEcon Search.

Help ensure our sustainability.

Give to AgEcon Search

AgEcon Search
<http://ageconsearch.umn.edu>
aesearch@umn.edu

*Papers downloaded from **AgEcon Search** may be used for non-commercial purposes and personal study only. No other use, including posting to another Internet site, is permitted without permission from the copyright owner (not AgEcon Search), or as allowed under the provisions of Fair Use, U.S. Copyright Act, Title 17 U.S.C.*

Czech University of Life Sciences Prague
Faculty of Economics and Management

agris *on-line*

Papers in Economics and Informatics

<http://online.agris.cz>

ISSN 1804-1930
XIV, 2022, 1

International scientific journal
Prague

Agris on-line Papers in Economics and Informatics

The international reviewed scientific journal issued by the Faculty of Economics and Management of the Czech University of Life Sciences Prague.

The journal publishes original scientific contributions from the area of economics and informatics with focus on agriculture and rural development.

Editorial office

AGRIS on-line Papers in Economics and Informatics
Department of Economics of FEM CZU Prague
Kamýcká 129, 165 00 Praha-Suchdol
Czech Republic
Phone: +420 224 382 056
E-mail: agrisonline(at)pef.czu.cz

Publisher

Faculty of Economics and Management
Czech University of Life Sciences Prague
Kamýcká 129, 165 00 Praha-Suchdol
Czech Republic
Reg. number: 60460709

ISSN 1804-1930

XIV, 2022, 1
30th of March 2022
Prague

Agris on-line
Papers in Economics and Informatics

ISSN 1804-1930

XIV, 2022, 1

Content:

K. B. Amolegbe, M. O. Adewumi: Agribusiness Firms and Rural Dairy Development. A Case of FrieslandCampina Dairy Development Programme in Nigeria	3
O. Y. Atasel, Y. Guneyasu, U. K. Pata: Testing the Agricultural Induced EKC Hypothesis: Fresh Empirical Evidence from the Top Ten Agricultural Countries.....	19
E. Dobošová, D. Hupková, P. Švikruhová, O. Beňuš, E. Gurčík: Analysis of Deviations – the Role of Controlling in Small and Medium Sized Agricultural Enterprises	33
O. A. Chernova, I. V. Mitrofanova, I. Adamickova, E. V. Kleitman: Digitalization of Agricultural Industry – the Vector of Strategic Development of Agro-industrial Regions in Russia	45
A. Jambor, A. Szerletics: Regional Impacts of Direct Payments on Farm Productivity and Efficiency in the European Union	59
H. Millia, P. Adam, A. A. Muthalib, Tajuddin, Y. P. Pastrun: The Effect of Inward Foreign Direct Investment and Information and Communication Technology on Economic Growth in Indonesia.....	69
A. Novotná, K. Kočíšová: The Role of Banks in Financing the Slovak Agricultural Sector	81
M. K. Sudha, M. Manorama, T. Aditi: Smart Agricultural Decision Support Systems for Predicting Soil Nutrition Value Using IoT and Ridge Regression	95
V. Šafář, K. Charvát, T. Mildorf, P. Crehan, D. Kolitzus, T. Orlickas, M. Rimgaila, A. Kučinskas, S. Rybokienė, Š. Horáková, H. Kubíčková: The Role of Remote Sensing in Agriculture and Future Vision	107
I. Živělová, E. Svobodová, J. Palkovič: The Impact of Subsidies on the Development of Beekeeping in the Czech Republic	125

Agribusiness Firms and Rural Dairy Development. A Case of FrieslandCampina Dairy Development Programme in Nigeria

Khadijat Busola Amolegbe, Matthew Olaniyi Adewumi

Department of Agricultural Economics and Farm Management, University of Ilorin, Nigeria

Abstract

Rural development interventions funded by private agribusiness firms may positively or negatively affect rural farmers' welfare. A positive effect is that such interventions may provide farmers with market access. The negative effect could be that such firms may be solely motivated by profit and may exploit the farmers. In this paper, we explore the role of FrieslandCampina Dairy Development Programme, a multinational firm with headquarters in Europe, in improving the welfare of rural dairy farmers in Nigeria. We use a two-wave panel survey of 122 programme participants and 95 non-participants. We focus on two outcome measures – annual dairy income and daily milk yield - and use a pooled ordinary least squares method to understand the programme effect. We also explore the mechanism of effect by assessing the programme effects on farmers' sustainable dairy management practices using a negative binomial regression method. Our results suggest that the programme has positive welfare effects on farmers. We attribute these effects to farmers' access to reliable markets offered by the programme and the informal business arrangement between the farmers and the agribusiness firm. Potential policy implications include that governments should encourage other private agribusiness firms to set up similar development programmes.

Keywords

Dairy, Nigeria, agribusiness firms, FrieslandCampina, rural farmers.

Amolegbe, K. B. and Adewumi, M. O. (2022) "Agribusiness Firms and Rural Dairy Development. A Case of FrieslandCampina Dairy Development Programme in Nigeria", *AGRIS on-line Papers in Economics and Informatics*, Vol. 14, No. 1, pp. 3-18. ISSN 1804-1930. DOI 10.7160/aol.2022.140101.

Introduction

In the last two decades, the roles large agribusiness firms, mostly with headquarters in Europe, play in strengthening the agricultural and rural sectors in developing countries have been of interest to researchers and policymakers. Agribusiness (agro-processing) firms have been broadly involved in supplying rural farmers with inputs and new technology (Arouna et al., 2019), providing rural households with social amenities (Michelson et al., 2017), and serving as reliable markets for products of rural households (Meemken and Bellemare, 2020). However, evidence on the impacts of the firms' activities on rural farmers' welfare varies greatly in literature. Singh (2002) believes that large firms often camouflage as having good intentions towards developing the rural economy, but many agro-processing firms' harbour exploitative motives towards rural farmers. Firms are motivated by profit, and in a bid to maximise profit, firms involved in contract arrangements with rural farmers may, for example, offer farmers

uncompetitive prices thereby short-changing the farmers (Ngeleza and Robinson, 2013). Moreover, firms' activities in rural areas are often not voluntary, and many firms would rather not participate in the sector. But because of specified corporate social responsibility - CSR (Setboonsarng, 2008) or government policies (Glover, 1984, Bonilla et al., 2018), firms are forced to engage in rural sector development. Hence, using the FrieslandCampina Dairy Development Programme (DDP) as a case study, we explore the role of agro-processing firms in improving rural farmers' market access and welfare.

FrieslandCampina West Africa Milk Company (WAMCO) Nigeria Limited is a private multinational firm with headquarters in the Netherlands, and it is the largest importer and processor of milk products in Nigeria (Köster and de Wolff, 2012). The company, like many other major milk processors in the country, mainly repackages and reconstitutes imported powdered and evaporated milk products. However, in line

with the Nigerian government's Local Content Act (LCA) of 2010 and the government's objective of growing the agricultural sector, the company decided to increase its local content to 10% by locally sourcing fresh milk from local farmers. Hence the company launched the DDP in 2011, setting up four milk collection centres (MCCs) and targeting local dairy farmers, mostly Fulani cattle herders, located within 30kms to any MCCs. The programme also provides participating farmers with training on efficient farming techniques and link the farmers with input suppliers, to improve the quality of milk farmers supply to the MCCs.

Generally, abundant literature exists linking dairy development interventions in developing countries to rural farmers welfare improvement (Holloway et al., 2000; Yahuza, 2001; Bonilla et al., 2018). In Nigeria, for example, Yahuza (2001) explores various milk development schemes in the country targeted at improving the production and marketing of dairy products. He notes that despite government investment in dairy development, the gap between supply and demand for dairy products continues to widen, thus recommends the need to involve other actors (like the private sector) in rural dairy development. However, there is no known empirical evidence on the importance of private sector involvement in rural dairy development in Nigeria. However, in Kenya, which has a more developed dairy sector than Nigeria, Bonilla et al. (2018) find that the Smallholder Dairy Commercialisation Programme (SDCP) was successful in increasing market access and rural welfare.

Development interventions, generally, can affect rural farmers' welfare through many channels. Bayer and Kapunda (2006) note that development programmes targeted at increasing farmers' market access often increase productive asset investment, like herd size. The authors attribute this increase to access to a guaranteed market outlet which may, in turn, lead to an increase in farmers welfare. Gelan and Muriithi (2015) and Bonilla et al. (2018) note that farmers welfare is improved by adopting sustainable dairy management practices such as improved feeding practices and hygiene techniques, and such practices may lead to increased milk production efficiency and earnings. Holloway et al. (2008), Barrett et al. (2012), Burke et al. (2015), and Edirisinghe and Holloway (2015), however, note that the proximity of farmers to infrastructural facilities and processing sites may also be associated with the farmers' welfare. Though, Stiglitz (1989) argues that, although development interventions may ameliorate the adverse effect

of market imperfection and provide positive welfare effects, the effect large firms in ameliorating such market failures and imperfection, may be insignificant especially in developing countries. We, therefore, answer the following questions:

- Does the FrieslandCampina Dairy Development Programme improve the welfare of rural dairy farmers?
- Is the use of sustainable dairy management practices linked to dairy farmers' welfare? That is, is the pathway of programme effect through farmers' use of sustainable dairy management practices?
- Are there differences in programme participation effects across various socio-economic groups?

The FrieslandCampina DDP is a relevant case study within rural studies and development economics literature due to the objective of the programme to increase farmers' access to market and develop rural farmers welfare. Our study will add to the literature addressing the relevance of agribusiness firms in rural welfare development. The programme is also relevant to a broader audience because, unlike many other development programmes, it is mainly funded by a private (multinational) agribusiness firm whose main aim is profit-making and whose products are sold in many West African countries. FrieslandCampina also has the largest market share of about 75% in the Nigeria dairy industry.

Understanding the effects of FrieslandCampina Dairy Development is also particularly valuable considering the trade relationship between Europe and Nigeria (and SSA as a whole) with regards to the dairy sector.

Figure 1 shows that although sub-Saharan Africa has a large cattle population, there is low total milk production which makes the countries major importers of milk dairy products. While having roughly the same number of cattle, SSA countries (below the curve) import milk from European countries (above the curve). However, with the steep increase in the prices of dairy commodities on the international market due to growing global demand for milk (mainly from China), droughts, fluctuation of the exchange rate in SSA, and the weakening of the Euro, other multinationals in Europe may seek to source milk from the untapped local dairy sector in developing countries (Leister et al., 2013, Knips, 2005).

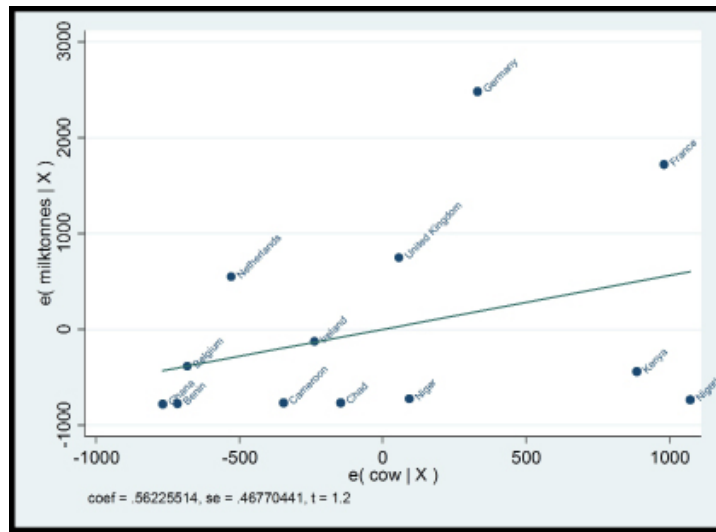

Source: authors

Figure 1: Relationship between cattle population and milk production by countries.

The remaining section of this paper is as follows: section 1 further describes the FrieslandCampina DDP. Section 2 describes the data employed for this study and gives the empirical strategy employed to answer the research hypotheses. Section 3 provides the descriptive results and gives the results and discussion from our empirical analyses, and section 4 shows the conclusion and policy implication of this research.

Nigeria dairy sector and FrieslandCampina Dairy Development Programme

In this section, we give a brief description of the Nigeria dairy sector compared to the dairy sector of the developed world. We also give a brief history and explain the governance restructure of the FrieslandCampina DDP, and we explain the nature of the business arrangement between the agribusiness firm (FrieslandCampina) and the farmers.

Nigeria and the global dairy sector

The structure of the dairy sector in Nigeria is characterised by fragmented smallholder dairy farmers, mostly Fulanis, and unorganised farms operating on a non-commercial basis with farmers operating without government support and subsidies. Although the country has one of the largest cattle population in the world, the farmers are subsistence, have no access to storage facilities and use crude techniques for production, thereby resulting in low production. The local breeds of cattle reared by farmers are also low yielding, mainly meat producers and not high milk producers as compared to other exotic

breeds. For example, the white Fulani breed yields only about an average of 0.7 – 1.5 litres of milk per day (Michael et al., 1991) while the pure exotic breeds such as Fresian can give about 8 to 18 litres of raw fluid milk per day (Ilu et al., 2016). On the other hand, the dairy sector in developed countries is well organised. Farmers in developed countries like the Netherlands operate in cooperatives and have access to producer subsidies from governments to encourage surplus production which is exported to the global markets. Knips (2005) note that the EU spends about Euro 16 billion a year in support of its dairy industry, and the farmers use sustainable dairy management practices and have access to improved technology and facilities to help increase production.

Dairy is one of the most important products consumed by Nigerians with an estimated annual milk consumption of 1.7 million tonnes, and the local production is only 0.6 million tonnes per annum. The demand for dairy products continues to increase with increasing population and urbanisation, and the importation is used to bridge the demand gap despite the high cattle population. However, dairy importation comes at a cost as Nigeria expends about \$480.3 million per annum on dairy importation from countries such as Australia, New Zealand, the European Union, India and the United States of America (Ekumankama et al., 2020). Policymakers seek ways to reduce the foreign exchange expense on milk importation, increase global milk output, and reduce global poverty and inequality through public-private partnerships with SSA governments

and private firms in developed countries. An example of such an intervention is the Dairy Development Programme.

Dairy Development Programme: governance structure and responsibilities

In line with the Nigerian government's Local Content Act of 2010, FrieslandCampina signed a Memorandum of Understanding (MoU) with the Federal Ministry of Agriculture and Rural Development in 2011 and went on to set up four MCCs in Fulani settlements in Oyo State, Nigeria. The programme was placed in Oyo state because of the proximity to Lagos state, where the processing factory is located, and the cattle population in the state. Figure 2 depicts the map of Nigeria, showing cattle population and distance to the agro-processing firm in Lagos, Nigeria.

Fulani cattle herders are the major milk producers in Nigeria, and cattle rearing is regarded as part of the Fulani culture. However, only the settled and semi-nomadic Fulani farmers in Oyo state are targeted under the DDP. According to the company, the programme was set up to build institutional capacity and self-organisation to enable the farmers to become partners in a coordinated Dairy Value Chain (DVC), thereby advancing rural dairy development in Nigeria.

DDP is being governed by core partners, namely FrieslandCampina West Africa Milk Company (WAMCO), hereafter referred to as FrieslandCampina, 2SCALE/International

Fertilizer Development Center (IFDC) and the Federal Ministry of Agriculture and Rural Development (FMARD), with contributions from Fulani Milk Producers (FMPs) and inputs suppliers (Köster and de Wolff, 2012). Under this programme, the Fulani herdsmen are supported through consistent training and demonstrations to upgrade their milk supply regarding quantity and quality. They are also trained on other improved and sustainable farming techniques such as the use of crop residues and fortification as sources of good feed to cattle, feed preservation through silage and haymaking and crossbreeding through artificial insemination.

These extension services are carried out in partnership with the IFDC/2SCALE project, whose main activities have been geared towards poverty alleviation and income security and building institutional capacity and self-organisation in Nigeria (Köster and de Wolff, 2012). FrieslandCampina has the responsibility of intermediation in the sale of veterinary drugs at the MCCs and offering basic extension assistance to the farmers on an effective herd health programme, milking hygiene and quality. The FMARD has the responsibility to finance and construct grazing reserves, feeder roads, water dams, boreholes and other structures. It also delivers efficient communal veterinary services in the MCC clusters like various vaccination campaigns, eradicating tsetse flies (Köster and de Wolff, 2012).



Source: authors

Figure 2: Map of Nigeria showing the Cattle Distribution and Estimated Distance of Cattle Dense States to Lagos.

Purchasing arrangements and price determination

The relationship (arrangement) between the farmers and the agro-processing firm is informal, with no rigid duration. However, programme eligibility is based on the distance to any of the MCCs. Farmers should be located within a 30 km radius and are expected to supply good quality milk daily (every morning), usually before 9.00 am. After that, the milk goes through different quality checks and control at the MCCs and can either be rejected or accepted. FrieslandCampina has the responsibility of daily receiving and controlling milk at the MCCs. Milk may either be brought by the transportation agent or by the farmer. The milk is usually stored and transported using specially fabricated cylinders (10, 20 and 40 litres capacity) given to farmers for free (Köster and de Wolff, 2012).

Milk collected at all MCCs is sent to the milk bulking centre for bulking further quality check before transporting to the processing factory in Lagos (about 220 km to these MCCs and milk bulking centres), where an additional quality check is done. Milk collection, bulking, and transportation to the agro-processing firm is done daily. From the inception of the programme in 2011 to October 2017, about 13,068,319 litres of milk has been collected from the farmers (Figure 3).

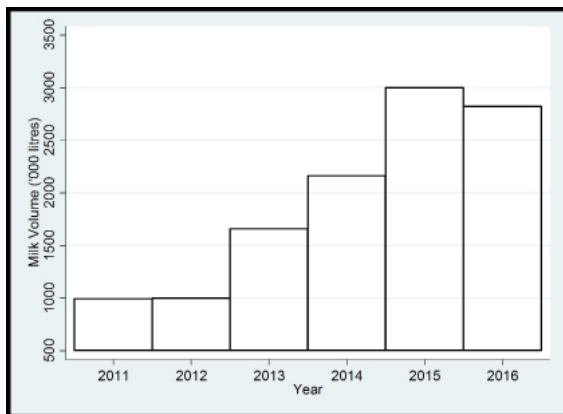

Source: authors

Figure 3: Milk Supply Trend (2011 -2016).

The quantity supplied increased with the opening up of additional milking clusters and MCCs. However, the amount supplied dropped by 6% between 2015 and 2016. As of 2016, there were four MCCs and one milk bulking centre (MBC). The MBC is in Iseyin, and the four functional MCCs are in Fashola, Alaga, Maya and Iseyin towns in Oyo State (Ekumankama et al., 2020).

Fixed and uniform prices are paid per litre of milk supplied by the farmers to the MCCs all year-round; prices are not seasonal. Prices were determined through collective bargaining between the collaborating parties. However, prices paid are often lower (on average) than the prevailing price in the informal (public/open-air) market. Fees are paid in cash or through banks. Fees include the cost of transportation (\$0.096/litre of milk) and milk value (\$0.576/litre of milk) (Köster and de Wolff, 2012).

Materials and methods

Our study area is Oyo state, Southwest Nigeria, and the target population are Fulani dairy farmers located within a 30 kms radius to any of the MCCs, that is, falling within the region of the DDP. Figure 4 shows the map of Oyo state showing the vegetation belts and the location of the MCCs. Oyo state is located within latitudes 70 and 9010'N, and longitudes 2040' and 4035'E and covers 28,454 square kilometres. The state has an estimated population of 5,580,894 people and 33 Local Government Areas (LGAs) (National Population Commission, 2006). The state has a West African monsoon climate, marked by distinct seasonal shifts in the wind pattern. The average daily temperature ranges from 25°C to 35°C. The vegetation of the state is mainly swamp forests with small areas of rainforests and deciduous forest/savannah mosaic scattered in between, making it suitable for cattle rearing.

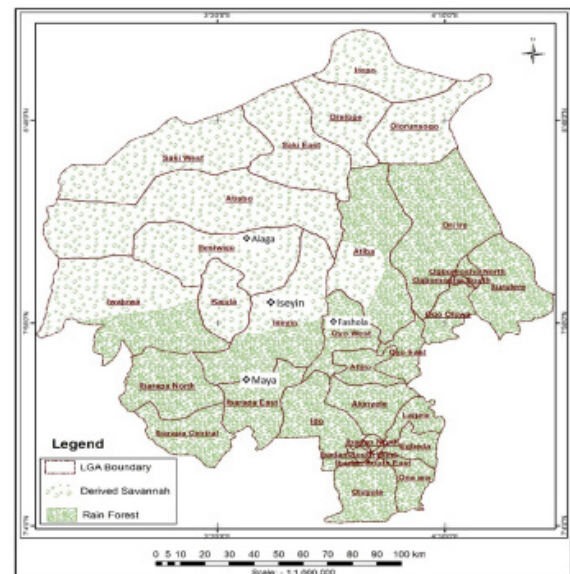

Source: authors

Figure 4: Oyo state map showing the vegetation belts and the location of the MCCs.

We carry out two surveys with the help of independent extension agents familiar with the area covered by the DDP. Our idea is that since we do not have baseline statistics of farmers, a panel survey of farmers will help increase the precision of the programme effect estimates. We do not, however, expect much variation in farmers characteristics between these periods. The initial survey was in July/August 2016 and a follow-up survey in June/July 2017, and hereafter, we refer to the initial survey as wave 1 and the follow-up survey as wave 2. It is important to note that, although we expect seasonal variations in dairy income and yield, we do not account for seasonal variations as both surveys fall during the rainy season.

We randomly sample farmers located within 30kms to any of the four MCCs, and the sample includes 217 farmers, including both participants (122) and non-participants (95). We select participating farmers using a list of all programme participants (1720) provided by FrieslandCampina field officers and the non-participating farmers from a list provided by the local heads around each of the MCCs. We recognise that a household may consist of more than one dairy farmer; hence we survey one farmer per household, and our study sample is made up of farmers from separate households. Although the intrahousehold dynamics may be of interest for other studies, for simplicity, our unit of analysis is at the individual, not household, level.

Using interview schedules and questionnaires, we collect data on the farmers' characteristics: sex, education level, programme participation status, distance to MCCs, distance to the local market, herd size annual income and output and sustainable management practices farmers use. Our measures of welfare are farmers' annual dairy income and average daily yield per cow. We do not use total income or consumption to measure welfare because farmers often find it hard to recall such information and using such for our analysis may bias our estimates. Data on average yield per cow is for yield per cow on the day of the survey interview. It is important also to note that, although the difference in yield may be attributed to the breed of the cow, the respondents in this sample and dairy farmers in the south-western part of Nigeria rear mostly the White Fulani breed of cattle due to its resistance to trypanosomiasis (RIM, 1992). Hence, we do not expect a difference in yield to be linked to the breed of cow. Exploring two outcome

measures is important for comparison and robustness since both measures are only approximations of the real values and based on recall for many of the farmers.

We use the (FAO, 2011) list of sustainable dairy management practices to identify the sustainable practices required by the farmer. The use of these practices by farmers ensures that the milk produced is safe and suitable for their intended use. The practices focus on six main dimensions, and each area has different indicators. These dimensions include animal health (21), milking hygiene (15), nutrition (14), animal welfare (22), environment (10), and socio-economic management (13). Note that the values in round brackets are numbers of indicators for each of the dimensions. For each of the indicators (and for each dimension), farmers are asked closed-ended questions, like if they use a particular dairy management practice. Farmers are expected to give either a yes or a no answer. A farmer that answers yes is regarded as using that management practice. For instance, using one of the 13 indicators of sustainable socio-economic management practices as an example, we ask if the farmer complies with relevant occupational health and safety requirements. A yes = 1 and no = 0. A farmer who answers yes to all 13 indicators of sustainable socio-economic management is considered as employing all the sustainable socio-economic management practices, while a farmer who uses none employs no sustainable socio-economic management practice. The same interpretation applies to each of the six dimensions. A sum of all the indicators of the dimensions gives the total number of sustainable dairy management practices (95) we consider for this study. However, it is important to note that this sustainability is limiting as we do not account for the duration, degree or extent of use.

We also use administrative data such as daily milk output, farmer list, details on MCCs. The data were collected from FrieslandCampina and 2SCALE/ International Fertilizer Development Center (IFDC).

Empirical strategy

In this section, we describe how we analyse the effect of FrieslandCampina DDP on farmers' welfare by testing the following hypotheses:

- The FrieslandCampina Dairy Development Programme has positive welfare effects on rural dairy farmers.

- Farmers' use of sustainable dairy management practices has a positive effect on farmer's dairy yield, and the effect is larger for the programme participants than the non-participants.
- Heterogenous differences in programme participation exist across various socio-economic groups. The effect of the programme is larger among farmers' residing close to any of the MCCs compared to those living far ways.

It is important to note here that making causal claims about the programme effect is difficult as unobserved variables may be correlated with farmers participation status and the farmers' welfare. A group of farmers may self-select into the programme, or the agribusiness firm may have placed the programme close to a targeted group of farmers. These situations (self-selection bias and programme placement bias) may lead to endogeneity which may confound our estimation. Hence, we employ a pooled OLS model which accounts for omitted variables to the extent that these unobserved factors are time-invariant farmers' characteristics, and the model for testing the effects of the programme on farmers is given as:

$$\begin{aligned}
 Y_{it} = & \beta_0 + \beta_1 P_i + \beta_2 D_i + \beta_3 P_i D_i + \\
 & + \sum_{x=1}^6 (\beta_4 S_i^x + \beta_5 S_i^x \times P_i) + \\
 & + \beta_6 I_{it} + \beta_7 T_i + \epsilon_{it} \quad (1)
 \end{aligned}$$

Y_{it} is the outcome measure of interest - logarithm of the annual dairy income or yield - of farmer i in period t . P_i is the farmers' participation status, where 1 represents programme participants and 0, non-participants. We do not expect the farmers' participation status to change over time. β_1 shows the effect of programme participation on farmers' welfare. This estimate is expected to be positive. Our identifying variable is farmers' distance to MCC in kilometres (D_i) as this is an important criterion for participating in the programme, and it is, therefore, a good predictor of participation. β_2 is the parameter estimate showing the effect of distance to MCC on farmers' welfare. This relationship is expected to be negative. We also include the interaction of farmers' participation status and distance ($P_i D_i$).

$\sum_{x=1}^6 S_i^x$ is the vector of sustainable dairy management practice, x , that farmer i use and the interaction term with farmers participation status P_i . We have six dimensions of sustainable dairy management practices, indexed by x : animal health, milking hygiene, nutrition, animal welfare, environment,

and socio-economic management. I_{it} represents a vector of farmers' characteristics such as distance to market (in kilometres), age (in years), square of age, sex (male = 1, female = 0), education level (no formal education = 0, primary education = 1, lower secondary = 2, higher secondary = 3 and tertiary = 4), household size, number of lactating cows, and size of land owned (in hectares). The farmers characteristics also include a control for MCC (0 = Maya, 1 = Alaya, 2 = Fashola, and 3 = Iseyin). All farmers (including non-participants) are attributed to the MCC closest to them. T includes a control for survey wave (wave 1 = 1 and wave 2 = 0) and the interaction between the survey wave and the farmers' participation status. We, however, note that the pooled OLS model does not consider possible selection bias in programme participation which could confound programme effect estimation. For example, participants may be more productive than non-participants and have higher dairy income regardless of whether they participate in the programme.

To test the second hypothesis, the mechanism of programme effect on farmers welfare is through farmers use of sustainable dairy management practices. We employ a negative binomial regression model and express the model as follows:

$$S_i^x = \delta_0 + \delta_1 P_i + \delta_2 D_i + \delta_3 P_i D_i + \delta_4 I_{it} + \epsilon_i \quad (2)$$

S_i^x is the number of sustainable dairy management practices, x , that farmer i use. We run separate regressions for the total sum of the sustainable dairy management practices farmers use and for each of the six dimensions mentioned earlier. All other variables are as earlier explained. We also test for overdispersion to check if the negative binomial model is a better choice compared to the Poisson model, but we do not discuss the results.

We also test for the third hypothesis, which states that differences exist in programme effects across various socio-economic groups. We group farmers into the following categories: sex (male versus female), age (old versus young), distance to MCC (close versus far), education (educated versus not educated), and MCC location (Alaya, Fashola, Maya, Iseyin). And we restrict our analysis (using equation 1) to each of these subgroups. We consider farmers to be old if they are above 35 years of age and young if 35 years or below. Farmers close to the MCC are within a 20km radius to any of the MCC, while those far away are above 20 km but still within a 30 km radius to any of the MCCs.

Educated farmers are at any level of education (primary, secondary or tertiary), while uneducated farmers have no formal education. We also compare farmers within the same MCC location. All farmers (including non-participants) are attributed to the MCC closest to them.

Results and discussion

Exploring the link between FrieslandCampina DDP and rural dairy farmers' welfare requires an understanding of farmers' characteristics and farm statistics. In this section, we first present and discuss the results from the descriptive statistics. We explain the results from the empirical analyses, testing each of the three hypotheses we stated earlier.

Farmer characteristics

Table 1 shows the summary of basic characteristics at wave 1 of farmers in our survey. Columns 1 and 2 show the average and standard deviation values of all the farmers in the sample, columns 3 and 4 show the values for participants, and columns 5 and 6 for the non-participants. The last column shows the differences in the mean values of the characteristics of programme participants and non-participants.

Participants live closer, on average, to any of the four MCCs than non-participants. The participants also tend to be more highly educated, and female farmers form a larger share

of the participants compared to the non-participants. We take caution in explaining the results because we do not have baseline statistics of the farmers. Hence, we cannot say if these farmers (educated farmers, female farmers and farmers living close to the MCCs) self-selected into the programme. However, we note that the programme may have been specifically targeted at female farmers, mostly in charge of household milk production and marketing (Bonilla et al., 2018). We explain the problem of self-selection (and then endogeneity) in the empirical strategy section of this paper.

Nevertheless, we find no statistically significant difference between the averages of the two groups concerning their age, household size, herd size (number of lactating cows), and size of land owned, and distance to the commercial market.

Farmers' welfare

We use two measures of welfare for our study. These are annual dairy income and average daily milk output per cow (yield). Table 2 shows the summary statistics of farmers' dairy income and yield at waves 1 and 2. Columns 1 and 2 show the average values for the participants and non-participants, respectively, and column 3 shows the t-test difference (diff) in the mean between the two groups of farmers for each of the waves. The table also shows the t-test difference (Diff) in mean across time for each of the groups of farmers.

	Total		Participants		Non-participants		diff
	Mean	Std. dev	Mean	Std. dev	Mean	Std. dev	
Distance to MCC (km)	21.05	5.47	19.44	5.58	23.11	4.59	3.663***
Distance to market (km)	32.71	9.71	32.35	8.49	33.18	11.11	0.826
Age	37.19	10.52	36.86	11.52	37.62	9.11	0.76
Female (%)	46.08	49.96	54.1	50.04	35.79	48.19	-0.183**
Male (%)	53.92	49.96	45.9	50.04	64.21	48.19	0.183**
Household size	8.04	3.74	8.08	3.78	7.98	3.71	-0.103
No formal education (%)	24.88	43.33	4.1	19.91	51.58	50.24	0.475***
Primary (%)	64.98	47.81	80.33	39.92	45.26	50.04	-0.351***
Lower secondary (%)	3.69	18.89	5.74	23.35	1.05	10.26	-0.0469
Higher secondary (%)	4.61	21.01	6.56	24.86	2.11	14.43	-0.0445
Tertiary (%)	1.84	13.48	3.28	17.88	0	0	-0.0328
Number of lactating cows	17.8	8.36	17.43	6.85	18.27	9.98	0.847
Land size (ha)	3.69	2.71	3.8	3.01	3.55	2.28	-0.256
N	217		122		95		217

Note that: Distance to market is the farmers' distance to the closest informal (open-air) market. We use data on the number of lactating cows as a proxy for herd size. All the dairy farmers are also involved in arable crop farming, and the variable land size is the size of land farmers use to cultivate arable crops *** p<0.01, ** p<0.05, * p<0.1
Source: authors

Table 1: Summary of farmers' characteristics in wave 1.

	Participants	Non-participants	diff
<i>Average dairy income per year in USD (\$)</i>			
Wave 1	586.89	426.10	-160.82***
Wave 2	682.27	349.84	-332.43***
Diff	-95.38***	76.23**	
<i>Average yield (litres/day/cow)</i>			
Wave 1	1.96	1.76	-0.21***
Wave 2	1.97	1.79	-0.19***
Diff	-0.01	-0.03*	
N	122	95	217

Note that: diff shows the difference between participants and non-participants while Diff shows the difference between waves 1 and waves 2 for participants and non-participants. 1 naira = 0.00328 US dollar (CBN, 2017). *** p<0.01, ** p<0.05, * p<0.1
Source: authors

Table 2: Summary statistics of farmers dairy yield and income.

The participants earn, on average, about 30% more annual dairy income than the non-participants. The explanation for this is that participants have access to reliable markets all year round through the FrieslandCampina MCCs. Also, the average litre of milk produced per cow per day for participants is about 10% higher than that of the non-participants. The average yield by non-participants is in line with Mrode (1988) and Michael et al. (1991). Participants' use of higher-yielding cow for milk production may also be related to the higher income earned compared to the non-participants. The FrieslandCampina programme has introduced farmers to other improved farming methods and has linked farmers to suppliers of high quality(veterinary) products. Participants access to these services may explain the higher yield per cow compared to non-participants. The participants also seem to be better off in wave 2 than wave 1, suggesting that farmers are getting better with time as they are more familiar with the business arrangement facilities and services introduced to them by the programme.

Sustainable dairy management practices

Figure 5 shows a summary of the number of sustainable dairy management practices farmers use in dairy production. The horizontal axis indicates the number of practices, and the vertical axis shows the six dimensions of sustainable dairy management practices (FAO, 2011). Of all the dimensions, participants and non-participants are only statistically different for the average number on sustainable milking hygiene and environmental management practices used. Both groups of farmers use an average of 79 out of the total (95) sustainable dairy management practices we explore.

However, participants use more sustainable milking hygiene practices compared to non-participants. Such milking hygiene practices include appropriate udder preparation before milking and the use of clean water on the farm. Using milking hygiene practices seem more important to participants than non-participants because participants who fail to use such practices fall at the risk of getting their milk rejected at the MCC. The quality of milk is tested at the MCC before it can be accepted, and only farmers with good quality milk will be paid. Non-participants, on the other hand, may not have to take as much precaution since they sell in the open market, where milk quality and safety are often not considered by the buyers. Surprisingly, non-participants employ more sustainable environmental practices on their farm compared to participants. Examples of such practices include minimising the production of environmental pollutants and recycling farm waste. It is important to note that the magnitude of difference in average for the two dimensions (milking hygiene and environment) are small, albeit less than 1 unit; hence we are cautious in explaining the results further.

We give examples of indicators for each of the other dimensions, although not significantly different between the participants and the non-participants. Sustainable animal health practices farmers employ include vaccination of all animals and attending to sick animals quickly and appropriately. Sustainable animal nutrition practices include meeting the nutritional needs of animals and using different equipment for handling chemicals and feed. Animal welfare practices include using buildings and handling facilities that are free of obstructions

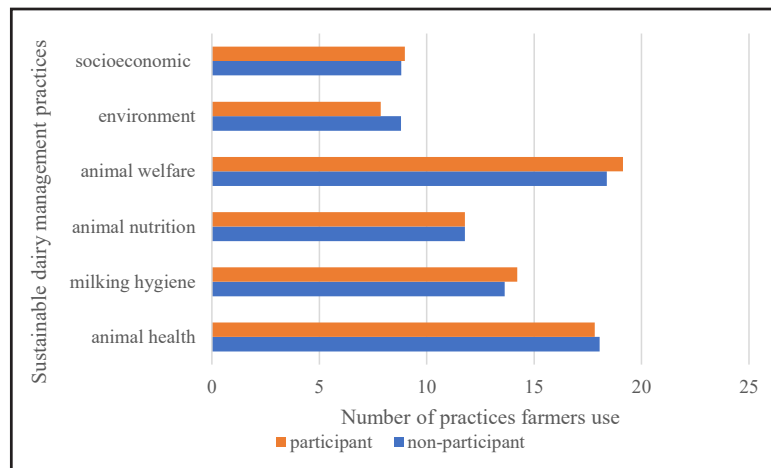

Source: authors

Figure 5: Summary of farmers' use of sustainable dairy management practices.

and hazards and protecting animals from adverse weather conditions. Socio-economic management practices include ensuring farm workers and staff carry out their tasks competently and ensuring the farm working environment complies with relevant occupational health and safety requirements.

Programme participation and farmers' welfare

First, we explain our result for hypothesis 1, FrieslandCampina DDP has a positive effect on participating farmers' welfare, using a pooled OLS method (see Table 3). Columns 1 and 2 show the effect on farmers' dairy income, while columns 3 and 4 show the yield effect. However, in columns 1 and 3, we do not include a control for the six dimensions of sustainable dairy management practices.

We see that our hypothesis is true for the two outcome measures. Participation in the DDP increases farmers' income and yield by about 67% and 11%, respectively, that is before controlling for the number of sustainable dairy management practices farmers use. However, excluding the variables accounting for sustainable dairy management practices may lead to omitted variable bias (Wooldridge, 2013). As mentioned earlier, the number of sustainable dairy management practices farmers use has a welfare effect on the farmers. Hence, we will only focus on interpreting the results presented in columns 2 and 4.

After controlling for the number of sustainable dairy management practices farmers use, results show that participation in the DDP increases

farmers' dairy income and yield by about 79% and 7%, respectively (more precise estimates than in columns 1 and 3). This result is not surprising, and the estimates support our descriptive statistics in Table 2. The explanation for the programme effect on dairy income is that participants have access to reliable markets all year round through the FrieslandCampina MCCs. This result is in line with the DDP aim of improving farmers welfare. Also, an assessment of a similar programme, SDCP, in Kenya (Bonilla et al., 2018) shows that development programmes targeted at providing market access and improving farmers participation will, in turn, improve farmers welfare.

The participants sell their products during the rainy season when there is usually a glut due to increased milk yield and excess milk supply. The non-participants, on the other hand, will have to either contend with wastage of their products or sell at a reduced price, lower than the price offered by the MCC -the price in the informal (local commercial) market is usually lower than prices at the MCC during the rainy season. During the dry season, cattle are less productive (yielding), and the milk supply is limited (Nguyen et al., 2019), and the price in the local markets is always higher than the price offered by the MCC. Participants may then choose to sell part of the milk produced in the open market and sell another part to the MCCs, thereby taking advantage of the price in the informal market. This is, however, possible because the business agreement between the farmers and the agribusiness firm, which is informal and flexible, especially regarding the quantity of milk farmers may supply

Variables	-1	-2	-3	-4
	Dairy Income		Yield	
Participate (1=yes)	0.669***	0.790***	0.110***	0.077*
	-0.117	-0.246	-0.02	-0.042
Distance to MCC (km)	-0.003	-0.004	0	0
	-0.004	-0.004	-0.001	-0.001
Participate x Distance	0.004	0.004	-0.001	0
	-0.005	-0.005	-0.001	-0.001
Sustainable dairy management practice	No	Yes	No	Yes
Animal health practices		-0.010*		-0.003***
		-0.006		-0.001
Participate x animal health practices		-0.001		0.004**
		-0.011		-0.002
Milking hygiene practices		0.035**		0.001
		-0.014		-0.002
Participate x milking hygiene practices		-0.016		0.002
		-0.022		-0.004
Animal nutrition practices		0.004		0.002
		-0.009		-0.002
Participate x animal nutrition practices		0.002		-0.003
		-0.014		-0.002
Animal welfare practices		0.006		-0.001
		-0.006		-0.001
Participate x animal welfare practices		-0.012		0
		-0.011		-0.002
Environmental practices		-0.023		0
		-0.015		-0.003
Participate x environmental practices		0.03		-0.002
		-0.019		-0.003
Socioeconomic management practices		0.001		0.004***
		-0.009		-0.001
Participate x socio-management practices		0.003		-0.002
		-0.014		-0.002
Constant	10.914***	10.670***	0.565***	0.571***
	-0.17	-0.217	-0.029	-0.037
Household characteristics	Yes	Yes	Yes	Yes
Time	Yes	Yes	Yes	Yes
Observations	434	434	434	434
R-squared	0.782	0.789	0.649	0.671

Note: Standard errors in parentheses *** p<0.01, ** p<0.05, * p<0.1
Source: authors

Table 3: OLS estimates of programme participation on farmers' dairy income and yield.

to the MCC. This result is in line with Erba and Novakovic (1995), who note that because milk is a perishable commodity, it could not be stored to make seasonal gains and to balance out the seasonal variations in supply and demand for milk. However, the DDP offers participant

farmers opportunities to make gains due to seasonal variations.

For effect on yield, the programme is specifically targeted at improving the yield of participating farmers by providing the farmers with training

on how to produce high quality and increase milk supply and by linking farmers to high-quality input suppliers (Köster and de Wolff, 2012). Increased yield can, in turn, increase the income participants earn from dairy production compared to the non-participants.

However, the caveat here is that dairy income is not the only income source for many Fulani farmers. The farmers are often involved in other income-generating activities like arable crop farming, beef production, and petty trading. We note that the result from Table 3 may not indicate the overall welfare effect on the farmer, but welfare as it relates to milk production only. Also, as mentioned earlier, there are other unobserved characteristics, like farmers' ability and cattle characteristics, that we do not account for. However, the findings in Table 3 provide a simple explanation of the programme effect on farmers.

Explaining the other variables besides the programme effect that we present in Table 3. We find that farmers' distance to MCC and its interaction term with farmers' participation status do not significantly affect the farmers' welfare. It suggests that, although farmers distance is linked to their probability of participating in the programme (Holloway et al., 2008), it does not have any welfare effect on the farmer. This supports our argument that farmers generally have other sources of income that may affect their welfare status. We also find that of all the six dimensions of sustainable dairy management practices, only sustainable animal health, milking hygiene, and socio-economic management practices are statistically significant welfare effects on farmers. The number of sustainable animal health practices farmers use reduces farmers' dairy income and yields by 1% and 0.3%, respectively. The results suggest that, although farmers may be using many animal health practices and probably spending a lot of their income in maintaining these practices, some farmers may be using the practices wrongly. Hence, the negative effects on income. However, participation in DDP and the use of sustainable animal health practices increase farmers yield by 0.4%. The number of sustainable milking hygiene practices farmers use also have a positive relationship (3.5%) with dairy income, while the number of sustainable socio-economic management practices farmers use has a positive relationship (0.4%) with yield.

Mechanism of programme effect

We explore the second hypothesis that the mechanism of programme effect is through participants' use of sustainable dairy management practices, in particular, through farmers' use of sustainable milking hygiene and animal health practices. Table 4 shows the negative binomial regression results to test our hypothesis, and the first column shows the programme effect on the total number of sustainable dairy management practices farmers use. Columns 2 to 7 show the programme effect on each sustainable dairy management practices dimensions we explained earlier.

Contrary to what we expect, we find that programme participation has no statistically significant effects on farmers use of sustainable dairy management practices. We note that although the programme has positive effects on farmers' welfare, we cannot ascertain that the use of sustainable dairy management practices is the mechanism of programme effect. This result is contrary to our a priori expectation that farmers welfare is improved by adopting sustainable dairy management practices (Gelan and Muriithi, 2015; Bonilla et al., 2018). We note that other factors like investment in productive assets, which we do not cover in our study, maybe a mechanism of programme effect.

We note that it could be that the farmers were also already using sustainable dairy management practises before the programme, and the numbers of practices farmers use may not be linked to their participation status. We cannot verify this claim since we do not have baseline data. We also note that the null results in Table 4 may be attributed to other measurement errors, like our measure of use of sustainable dairy management practices, which is by counting the numbers of practices farmers use. We do not account for the extent and intensity of use or the duration of use of these practices. We note that the degree of use of these practices may vary greatly between farmers. We also attribute our result to our inability to control for unobservable characteristics such as farmers ability to use these practices.

VARIABLES	Total	Animal health	Milking hygiene	Animal nutrition	Animal welfare	Environment	Socioeconomic
Participate (1=yes)	-0.074 (0.108)	-0.145 (0.162)	0.000 (0.186)	-0.156 (0.202)	0.120 (0.161)	-0.189 (0.240)	-0.216 (0.233)
Distance to MCC (km)	-0.002 (0.004)	-0.006 (0.006)	-0.001 (0.007)	-0.005 (0.007)	0.004 (0.006)	0.001 (0.009)	-0.006 (0.009)
Participate x Distance	0.004 (0.005)	0.007 (0.007)	0.002 (0.008)	0.008 (0.009)	-0.003 (0.007)	0.003 (0.011)	0.008 (0.010)
Constant	4.547*** (0.159)	3.245*** (0.237)	2.685*** (0.274)	2.606*** (0.296)	2.912*** (0.236)	2.339*** (0.348)	2.518*** (0.343)
Alpha (α)	.0122665***	1.92e-10	4.40e-11	8.71e-16	3.31e-10	9.65e-14	6.85e-13
Observations	217	217	217	217	217	217	217

Note: Alpha (α) is overdispersion parameter Standard errors in parentheses. *** p<0.01, ** p<0.05, * p<0.1
Source: authors

Table 4: Negative binomial coefficient estimates of programme participation on farmers' use of sustainable dairy management practices.

Subgroup analyses

Although from Table 4 we find that programme participants are on average better off than non-participants. We carry out subgroup analyses and group our sample according to their socio-economic characteristics: sex, education, age, distance to MCC, and location (MCC). We then test our third hypothesis; programme effects vary among participants and non-participants within the same socio-economic group. We focus on only the effect on dairy income. Figure 6 shows the plot estimate of the subgroup analyses. The horizontal axis shows the magnitude of the coefficient estimates of programme effect, the magnitude of the effect of participation on income for various restricted groups of the sample.

We find that programme participation increases income by 57.6% among the male farmers, while among the female farmers, programme participation increases income by 72.1%. The result suggests that the programme effect is wider among female farmers than among male farmers. The explanation for this is that male non-participants may be better off than female non-participants. Since female farmers are considered vulnerable, the programme offers female participants an opportunity to improve their welfare status.

We also note that the difference in programme effect between participants and non-participants increases with distance to the MCC (Barrett et al., 2012; Edirisinghe and Holloway, 2015). That is, regardless of farmers' age, sex, and education level, participants located within a 20km radius of any MCC are better off (67.9% higher income) than non-participants within the same radius. And among farmers residing far away from the MCC, programme participation increases

farmers income by about 75%. The interpretation is that among eligible farmers residing farther away from the MCC, the farmers who choose to participate in the programme are better off than their peers but do not participate. The effect is wider when compared with the group of farmers residing close to the MCC.

Also, for farmers residing around Maya or Fashola MCC, the effect of programme participation on dairy income is not significantly different between the participants and non-participants. However, programme effect on the welfare of farmers around Alaga and Iseyin MCC are significantly different and significant.

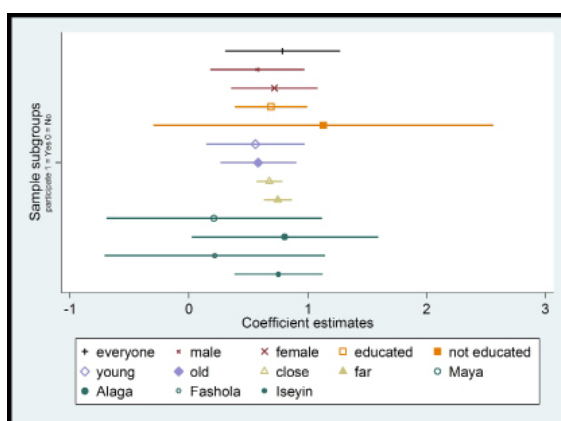

Source: authors

Figure 6: Coefficient plot estimates of subgroup analyses showing the effect of programme participation on dairy income.

Conclusion

In summary, we use a two-wave survey of dairy farmers in Oyo State, Nigeria to explore the effects of FrieslandCampina Dairy Development Programme on farmers' welfare. We focus

on Fulani dairy farmers located around each of the four MCCs set up by FrieslandCampina to collect raw milk from the farmers. It is important to note that our study is limiting. We could not explore the cost-benefit partition of farmers' participation in the dairy markets as in Ngeleza and Robinson (2013). We note that such analysis can provide further insight into the effects of the FrieslandCampina Dairy Development Programme. However, we note that farmers find it hard to recall information related to cost and revenue. Hence, we take a wide-ranging approach that the data allow, following the methods and features that prior research has identified to be important.

We focus on two outcome measures that are indicators of dairy farmers' welfare status - annual dairy income and daily milk yield. We employ pooled ordinary least squares estimates to show the programme effects on farmers. We control for other observable characteristics like age, sex, education and distance to market and MCCs. We also analyse the mechanism of programme effect on farmers' welfare by exploring the programme effect on farmers' use of sustainable dairy management practices. We employ a negative binomial regression model and focus on programme effects on the total number of sustainable dairy management practices farmers use. We further explore the programme effects on each of the six main dimensions of sustainable dairy management practices identified by FAO (2011). Finally, we explore sub-group analyses focusing on farmers socio-economic characteristics like sex, age, education, distance and location. The sub-group analyses help us to understand the heterogeneous effect of the programme on farmers welfare.

While there is a long history of investment intended to boost rural welfare and develop the local dairy sector through various agricultural and rural development policies, our findings reinforce the continued need to support rural farmers through the provision of reliable market access. The Federal Government should implement similar policies like

the Local Content Act or strengthen the existing policy to encourage other agro-processing firms to set up similar development programmes around the country. Such policies may also be targeted at encouraging the involvement of private firms in rural development, strengthening the synergy between the local producers and the agro-processors.

As part of the global effort to develop the rural and agricultural sector in sub-Saharan Africa, the European Union and other developed economies may implement development policies targeted at the rural dairy sector. Moreover, multinational firms in Europe and other developed countries sourcing milk products to meet the global demand may adopt the dairy development programme to tap into the rural dairy value chain in sub-Saharan Africa. Such programmes will help get the local milk products to the global market and help address the poverty rate in sub-Saharan Africa.

Other agro-processing firms seeking to set up similar programmes, especially in the dairy sector, may also adopt the 30km eligibility rule for programme participation. However, non-participants leaving are away from the milk collection sites should be encouraged to participate in the programme as such farmers will be better off participating than when they are not participating. FrieslandCampina may also offer milk pick up services to non-participants to encourage programme participation.

FrieslandCampina should embed a farmer literacy programme and encourage non-participants, especially those with no formal education, to participate. The government should invest in infrastructural facilities such as schools, good road networks and potable water sources. Such infrastructural facilities are important to ensure farmers use of sustainable dairy management practices. The firm should also intensify training on the appropriate use of animal health, milking hygiene and socio-economic management practices. The use of such practices has significant effects on rural dairy farmers welfare status.

Corresponding authors

Khadijat Busola Amolegbe, PhD.

Department of Agricultural Economics and Farm Management, University of Ilorin, Nigeria

Phone: +2348054238137, E-mail: busolatinwol@gmail.com

References

- [1] Arouna, A., Michler, J. and Lokossou, J. C. (2019) "Contract Farming and Rural Transformation: Evidence from a Field Experiment in Benin", NBER Working Papers 25665, National Bureau of Economic Research, Inc. DOI 10.3386/w25665.
- [2] Barrett, C., Bachke, M. E., Bellemare, M., Michelson, H., Narayanan, S. and Walker, T. F. (2012) "Smallholder Participation in Contract Farming: Comparative Evidence from Five Countries". *World Development*, Vol. 40, pp 715-730. ISSN 0305-750X. DOI 10.1016/j.worlddev.2011.09.006.
- [3] Bayer, W. and Kapunda, L. (2006) "Dairy cattle for poverty alleviation in Southern Tanzania", At *Conference on International Agricultural Research for Development, University of Bonn*, 11–13 October 2006. DOI 10.2307/j.ctv16zjjh3.8.
- [4] Bonilla, J., McCarthy, N., Mugatha, S. M., Rai, N., Coombes, A. and Brubaker, J. (2018) "Impact evaluation of the smallholder dairy commercialisation programme in Kenya". [Online]. Available <https://www.3ieimpact.org/sites/default/files/2019-01/IE73-Kenya-dairy-commercialization.pdf> [Accessed 24 Feb. 2020]. DOI 10.23846/tw4IE73.
- [5] Burke, W. J., Myers, R. J. and Jayne, T. S. (2015) "A Triple-Hurdle Model of Production and Market Participation in Kenya's Dairy Market", *American Journal of Agricultural Economics*, Vol. 97, pp. 1227-1246. ISSN 0002-9092. DOI 10.1093/ajae/aav009.
- [6] CBN (2017) "Monthly Average Exchange Rates of the Naira(Naira Per Unit of Foreign Currency) – 2017". [Online]. Available: <https://www.cbn.gov.ng/rates/exrate.asp?year=2017> [Accessed: 24 Feb. 2020].
- [7] Edirisinghe, J. C. and Holloway, G. J. (2015) "Crossbred cow adoption and its correlates: Countable adoption specification search in Sri Lanka's small holder dairy sector", *Agricultural Economics*, Vol. 46, No. S1, pp. 13-28. ISSN 0169-5150. DOI 10.1111/agec.12195.
- [8] Ekumankama, O., Ezeoha, A. and Uche, C. (2020) "The role of multinational corporations in local dairy value chain development: case of Friesland Campina WAMCO (FCW) in Nigeria", *International Food and Agribusiness Management Review*, Vol. 23, No. 1, pp. 55-70. ISSN 1559-2448. DOI 10.22434/IFAMR2018.0108.
- [9] Erba, E. M. and Novakovic, A. M. (1995) "The Evolution of Milk Pricing and Government Intervention in Dairy Markets", *Cornell University, Department of Applied Economics and Management*. [Online]. Available: <https://ecommons.cornell.edu/handle/1813/68878> [Accessed: 24 Feb. 2020].
- [10] FAO (2011) "Guide to Good Dairy Farming Practice, Food and Agriculture Organization of the United Nations". [Online]. Available: <http://www.fao.org/3/ba0027e/ba0027e00.htm> [Accessed 24 Feb. 2020].
- [11] Gelan, A. and Muriithi, B. (2015) "Examining Returns to Scale in Smallholder Dairy Farms in East Africa", *Quarterly Journal of International Agriculture*, Vol 54, No. 3, pp. 239 - 261. ISSN 0049-8599. DOI 10.22004/ag.econ.225952.
- [12] Glover, D. J. (1984) "Contract farming and smallholder outgrower schemes in less-developed countries", *World Development*, Vol 12, No. 11-12, pp. 1143-1157. ISSN 0305-750X. DOI 10.1016/0305-750X(84)90008-1.
- [13] Holloway, G., Ehui, S. and Teklu, A. (2008) "Bayes Estimates of Distance-to-Market: Transactions Costs, Cooperatives and Milk-Market Development in the Ethiopian Highlands", *Journal of Applied Econometrics*, Vol. 23, pp. 683-696. ISSN 08837252. DOI 10.1002/jae.1019.
- [14] Holloway, G., Nicholson, C., Delgado, C., Staal, S. and Ehui, S. (2000) "Agroindustrialization through institutional innovation: Transaction costs, cooperatives and milk-market development in the east-African highlands", *Agricultural Economics*, Vol. 23, No. 3, pp. 279-288. ISSN 0169-5150. DOI 10.1016/S0169-5150(00)00089-X.

- [15] Ilu, I., Frank, A. and Annatte, I. (2016) "Review of the livestock/meat and milk value chains and policy influencing them in Nigeria", Published by the Food and Agriculture Organization of the United Nations and the Economic Community of West African States, pp. 1-34. [Online]. Available: <http://www.fao.org/3/i5259e/i5259e.pdf> [Accessed 24 February 2020].
- [16] Knips, V. (2005) "Developing countries and the global dairy sector part I global overview", PPLPI Working Papers 23768, Food and Agriculture Organization of the United Nations, Pro-Poor Livestock Policy Initiative.
- [17] Köster, H. W. and De Wolff, J. (2012) "Dairy development programme in Nigeria baseline report: Key Findings and recommendations", Alabama: IFRC. DOI 10.22004/ag.econ.23768.
- [18] Leister, A. M., Lee, J. G. and Paarlberg, P. L. (2016) "Dynamic effects of drought on the US livestock sector", *Agricultural and Resource Economics Review*, Vol. 45, No. 3, pp. 459-484. E-ISSN 2372-2614, ISSN 1068-2805. DOI 10.1017/age.2016.4.
- [19] Meemken, E.-M. and Bellemare, M. F. (2020) "Smallholder farmers and contract farming in developing countries", In *Proceedings of the National Academy of Sciences*, Vol. 117, pp. 259-264. [Online]. Available: <https://www.pnas.org/content/pnas/117/1/259.full.pdf> [Accessed: 25 Feb. 2021].
- [20] Michael, W., Grindle, J., Nell, A. and Bachman, M. (1991) "Dairy development in sub-Saharan Africa: A study of issues and options", *Africa Technical Department Series No. 135*. World Bank Technical Paper, Washington, DC, pp. 27-209. [Online]. Available: <http://documents1.worldbank.org/curated/en/397001468768281624/pdf/multi-page.pdf> [Accessed: 20 Feb. 2020].
- [21] Michelson, H., Boucher, S., Cheng, X., Huang, J. and Jia, X. (2017) "Connecting supermarkets and farms: The role of intermediaries in Walmart China's fresh produce supply chains", *Renewable Agriculture and Food Systems*, Vol 33, pp. 47-59. E-ISSN 1742-1713, ISSN 1742-1705. DOI 10.1017/S174217051600051X.
- [22] Mrode, R. A. (1988) "Lactation performance of the White Fulani cattle in southern Nigeria", *Tropical Animal Health And Production*, Vol. 20, pp. 149-154. ISSN 0049-4747. DOI 10.1007/BF02240083.
- [23] Ngeleza, G. K. and Robinson, E. J. (2013) "Cartels and Rent Sharing at the Farmer–Trader Interface: Evidence from Ghana's Tomato Sector", *Journal of Agricultural and Food Industrial Organization*, Vol. 11, No. 1, pp. 15-30. ISSN 1542-0485. DOI 10.1515/jafio-2012-0011.
- [24] Nguyen, T. P. L., Seddaiu, G. and Roggero, P. P. (2019) "Declarative or procedural knowledge? Knowledge for enhancing farmers' mitigation and adaptation behaviour to climate change", *Journal of Rural Studies*, Vol. 67, pp 46-56. ISSN 0743-0167. DOI 10.1016/j.jrurstud.2019.02.005.
- [25] Setboonsarng, S. (2008) "Global partnership in poverty reduction: Contract farming and regional cooperation", ADB Institute Discussion Papers. [Online]. Available: <https://www.econstor.eu/handle/10419/53517> [Accessed: 24 February 2020].
- [26] Singh, S. (2002) "Contracting out solutions: Political economy of contract farming in the Indian Punjab", *World Development*, Vol. 30, No. 9, pp. 1621-1638. ISSN 0305-750X. DOI 10.1016/S0305-750X(02)00059-1.
- [27] Stiglitz, J. E. (1989) "Markets, market failures, and development", *The American Economic Review*, Vol. 79, pp. 197-203. ISSN 0002-8282.
- [28] Wooldridge, J. M. (2013) "Introductory Econometrics: A Modern Approach", 7th ed., Cengage Learning. ISBN 13 978-1-305-27010-7.
- [29] Yahuza, M. (2001) "Smallholder dairy production and marketing constraints in Nigeria. Smallholder dairy production and marketing—Opportunities and constraints", In: *Proceedings of a South–South workshop held at National Dairy Development Board (NDDDB) Anand, India*, 13–16 March 2001. pp. 201-214. [Online]. Available: https://cgspace.cgiar.org/bitstream/handle/10568/16607/SS_Proceeding.pdf?sequence=1 [Accessed: 24 Feb. 2020].

Testing the Agricultural Induced EKC Hypothesis: Fresh Empirical Evidence from the Top Ten Agricultural Countries

Oguz Yusuf Atasel¹, Yusuf Guneyusu¹, Ugur Korkut Pata²

¹ Department of Business Administration, Karadeniz Technical University, Trabzon, Turkey

² Department of Economics, Osmaniye Korkut Ata University, Turkey

Abstract

Within the scope of sustainable development goals and climate change mitigation, this study focuses on investigating the effects of energy consumption, agriculture, and economic growth on CO₂ emissions in the top ten agricultural countries for the period 1997-2016. By investigating the validity of the agricultural induced environmental Kuznets curve (EKC), the study mainly aims to explore how agricultural activities affect environmental quality. In doing so, this study utilizes the augmented mean group (AMG) estimator that allows for heterogeneity and cross-sectional dependence. The results of the AMG estimator suggest that the agricultural induced EKC hypothesis is valid for six out of the ten countries. The empirical results also indicate that agriculture reduces CO₂ emissions, while energy consumption accelerates environmental degradation. All these results suggest that agricultural production and economic development can play an essential role in reducing environmental pollution.

Keywords

Agriculture, EKC, energy consumption, heterogeneity, panel data.

Atasel, O. Y., Guneyusu, Y. and Pata, U. K. (2022) "Testing the Agricultural Induced EKC Hypothesis: Fresh Empirical Evidence from the Top Ten Agricultural Countries", *AGRIS on-line Papers in Economics and Informatics*, Vol. 14, No. 1, pp. 19-31. ISSN 1804-1930. DOI 10.7160/aol.2022.140102.

Introduction

Nowadays, environmental sustainability is an important issue for policy-makers and researchers. Environmental degradation seriously affects both sustainable development and human well-being. Since 1950s, human activities emitting greenhouse gasses (GHGs) have been considered as the most important cause of climate change (IPCC, 2013; Paramati et al., 2017). Among GHGs, carbon dioxide (CO₂) emissions directly contribute to global warming and enhanced greenhouse effects. Fossil fuel-based energy consumption (EC) is the primary source of CO₂ emissions. However, EC is an essential requirement for economic and social development (Cherni and Jouini, 2017; Zhang et al., 2019). In fact, EC and economic growth increased rapidly during and after the industrial revolution, which in turn resulted in an increase in CO₂ emissions. In other words, the expansion of economic activities has led to an unprecedented increase in global EC, which has caused severe environmental problems such as air pollution, deforestation, desertification,

and ozone depletion. These environmental problems bring ecological and sustainable development to the forefront.

The concept of environmental sustainability was first introduced in 1972 in the United Nations Conference on the Human Environment. The conference emphasized that economic growth will cause environmental problems. Later, in 1987, the United Nations published the report "Our Common Futures". This report stated that economic development and environmental sustainability should be considered together. In 1992, the "United Nations Conference on Environment and Development" was held in Rio de Janeiro to identify the basic principles for sustainable development. These attempts led to the recognition of the high environmental costs and the emergence of the concept of sustainable development.

In the context of the Sustainable Development Goals (SDGs), the United Nations' 2030 global agenda helps to develop political action both to protect the planet and to promote prosperity for all nations (Sarkodie and Owusu 2017). Accordingly,

the priority of the SDGs is to eradicate absolute poverty by 2030 (Muller et al., 2011). Agricultural sustainability coincides with some of the 17 SDGs. The SDGs that relate to agricultural activities can be listed as Goal 2: Zero Hunger, Goal 6: Clean Water and Sanitation, Goal 7: Affordable and Clean Energy, Goal 12: Responsible Consumption and Production, Goal 13: Climate Action, Goal 14: Life Below Water, and Goal 15: Life on Land. These SDGs are primarily aimed at increasing agricultural productivity.

Agriculture is an important component in achieving the SDGs, improving the quality of life, and reducing poverty and hunger (Ali et al., 2017; Ullah et al., 2018), which contributes to the improvement of the productivity of nations. Agricultural knowledge can support economic development by increasing competition in a country. In developing countries, it can be said that the effect of agricultural growth on poverty reduction is higher compared to other sectors (Timmer, 2009; Gokmenoglu and Taspinar, 2018). Higher productivity and production in agriculture are extremely important for the overall economic development of a country. The agricultural sector supplies raw materials to industry and provides food and feed for all living things. This sector also contributes to international imports and exports.

According to the World Bank (2020), the agricultural sector represented 43.68% of global employment in 1991, but this share declined to 26.86% in 2019. Although the share of agriculture in total employment has decreased over the years, this sector provides 1/4 of total employment. The decrease in employment in the agricultural sector is mainly due to the declining demand for labor. Mechanization in agriculture not only had a negative impact on employment but also had a significant impact on the environment. On the one hand, the machinery, tools, and equipment used in agriculture operate on fossil fuels, which are the main sources of air pollution (Chel and Kaushik, 2011; Liu et al., 2017). The agricultural sector uses non-renewable energy sources such as oil, natural gas, and coal to run machinery and equipment, heat or cool buildings, light the farm, and indirectly produce fertilizer, which leads to an increase in environmental pollution. On the other hand, CO₂ emissions can be significantly reduced through the use of environmentally friendly technologies and renewable energy in agriculture. In this regard, GHG emissions can be reduced by 80% by 2030 by regulating supply and demand in the agricultural sector. Agricultural pollution can be minimized

with practices such as afforestation on the supply side and reduction of losses in the food supply chain on the demand side (IPCC, 2014). The negative effects of climate change can also be reduced through measures such as the use of animal manure in agriculture, the conversion of agricultural residues into energy, thus reducing the need for fossil fuels and promoting renewable energy (Liu et al., 2017).

Based on the above information on sustainability, economic development, EC, and agriculture, this study analyzes the validity of the agriculture-based environmental Kuznets curve (EKC) hypothesis in the top ten agricultural countries (T10AGR, i.e., China, India, Indonesia, Brazil, the United States, Nigeria, Turkey, Japan, Argentina, and Thailand). The EKC hypothesis represents an inverted U-shaped relationship between income level and environmental degradation. According to Grossman and Krueger (1991), environmental pollution indicators increase as the economy expands, but after reaching a certain level of wealth, environmental degradation can be reduced with increasing environmental awareness and developing technologies. Recently, several researchers have tested the validity of the agriculture-induced EKC hypothesis by including agriculture as an independent variable in the analysis in addition to income level (see, e.g., Aziz et al., 2020; Prastiyo et al., 2020; Ridzuan et al., 2020). To date, the validity of the agriculture-induced EKC hypothesis has not been analyzed for most agricultural countries. To our knowledge, only Qiao et al. (2019) tested the validity of the agricultural EKC hypothesis for the G20 countries. However, G20 countries do not include major agricultural countries such as Thailand and Nigeria. In this context, the analysis of T10AGR countries might give us with different results. The leading macroeconomic indicators of the T10AGR countries are shown in Table 1.

As can be seen in Table 1, T10AGR countries account for more than 50% of EC, GDP, agricultural value-added, and CO₂ emissions worldwide. In this regard, it is crucial to determine the validity of the EKC hypothesis in the T10AGR countries, which are responsible for 52% of the global GDP. Moreover, agricultural production in these countries, which was US\$ 933 billion in 1997, increased by 93% and rose to US\$ 1.801 trillion in 2016. During the same period, global agricultural production growth was 66%. This indicates that T10AGR countries play an essential role in providing food supply in the world and contribute

Variables	1997			2016		
	T10AGR	World	Share	T10AGR	World	Share
GDP	21.976	45.187	48.63%	40.766	77.937	52.30%
AGRV	933	1.800	55.15%	1.801	3.000	59.96%
EC	5.107	10.435	48.94%	8.435	15.294	55.15%
CO ₂	12.370	24.191	51.13%	20.477	35.220	58.14%

Note: GDP and AGRV are measured in constant 2010 US dollars. EC and CO₂ emissions are measured in terawatt-hours and gigatonnes, respectively

Source: author's elaboration based on World Bank (2020), Global Carbon Project (2020), and Our World in Data (2019)

Table 1: Energy consumption, agriculture, GDP and CO₂ emissions in the T10AGR countries.

to meeting the needs of other countries by exporting agricultural products. Therefore, studying the environmental impact of the agricultural and energy sectors in T10AGR countries will provide important evidence for poverty alleviation and global warming.

Despite the extensive literature on the impact of agriculture on GHG emissions, few studies have analyzed the relationships between agriculture and CO₂ emissions in the EKC framework. (Gokmenoglu et al., 2019). In order to make more accurate decisions about the effects of agriculture on environmental pollution, it is important to test the agricultural EKC hypothesis for a different country or groups of countries and thus adding more evidence to the existing literature. In this context, our study contributes to the current literature in two ways. i) To our knowledge, this is the first attempt to test the validity of the agriculture-based EKC hypothesis in T10AGR countries. Examining the relationship between environmental pollution and agriculture in countries with intensive agricultural activities may provide findings that are more reliable. The T10AGR countries are responsible for 66% of the world's agricultural production. This ratio, which is equivalent to two-thirds of the world's agricultural activities, provides a general picture of the relationship between agriculture and environmental pollution. ii) The validity of the agricultural EKC hypothesis may change depending on the agricultural indicators. While some studies in the literature use the agricultural value-added (Liu et al., 2017; Gokmenoglu and Taspinar, 2018; Aziz et al. 2020), others have included agriculture's share of GDP in the analysis. (Balsalobre-Lorente et al., 2019; Dogan, 2019; Prastiyo et al., 2020). Using both agricultural indicators, we aimed to determine the impact of agriculture on CO₂ emissions in a more detailed and robust framework.

This study consists of five sections. A literature review is presented in the next section. The data,

model, and methodology used in the study are presented in the following section. Then, the empirical findings are reported and discussed. Finally, the conclusion and policy recommendations are given in the last section.

Literature review

Since the pioneering work of Grossman and Krueger (1991) and Shafik and Bandyopadhyay (1992), numerous research papers have investigated the EKC hypothesis, implying an inverted U-shaped relationship between environmental pollution and economic growth. Early studies included per capita GDP and per capita EC as independent variables in the analysis (see, for example, Selden and Song, 1994; Shafik, 1994; Holtz-Eakin and Selden, 1995). Subsequently, researchers have examined various variables such as foreign direct investment (Agboola and Bekun, 2019), human capital (Mahmood et al., 2019), industrialization (Pata, 2018a; Prastiyo et al., 2020), urbanization (Ridzuan et al., 2020), trade openness (Ben Jebli and Ben Youssef, 2017; Balsalobre-Lorente et al., 2019), and economic complexity (Yilanci and Pata, 2020) in analyzing the EKC hypothesis. Although the agricultural sector is an important factor in economic development, it was not a priority for researchers when testing the EKC hypothesis (Prastiyo et al., 2020). Recently, a limited number of studies have addressed the impact of agriculture on environmental pollution within the EKC hypothesis framework. The findings of these studies are summarized in Table 2.

Reviewing the existing literature, we conclude that the EKC hypothesis is validated in most studies that investigate the impact of agriculture on environmental pollution. However, Ben Jebli and Ben Youssef (2017) and Liu et al. (2017) failed to prove the EKC hypothesis. Moreover, there is no consensus among researchers about the influence of agriculture on environmental degradation. In eight of the 13 studies, researchers

Work	Countries	Time period	Method(s)	Variables	Agriculture-pollution nexus	A-EKC
Ben Jebli and Ben Youssef (2017)	Tunisia	1980-2011	Johansen-Juselius cointegration,	CO ₂ GDP, REC, NREC, TO AGRV	Agriculture →CO ₂ (+)	X
Liu et al. (2017)	ASEAN-4	1970-2013	Kao panel cointegration test, OLS, DOLS and FMOLS	CO ₂ GDP, REC, NREC, AGRV	Agriculture →CO ₂ (-)	X
Gokmenoglu and Taspinar (2018)	Pakistan	1971–2014	Maki cointegration, FMOLS	CO ₂ GDP, EC, AGRV	Agriculture →CO ₂ (+)	✓
Agboola and Bekun (2019)	Nigeria	1981-2014	Bayer-Hanck cointegration test,	CO ₂ GDP, TO, FDI, EC, AGRR	Agriculture →CO ₂ (+)	✓
Balsalobre-Lorente et al. (2019)	BRICS	1990-2014	Kao and Fisher panel cointegration tests, DOLS, FMOLS	CO ₂ GDP, ELC, MOB, TO, AGRR	Agriculture →CO ₂ (+)	✓
Dogan (2019)	China	1971-2010	ARDL, FMOLS, DOLS, CCR	CO ₂ GDP, EC, AGRR	Agriculture →CO ₂ (+)	✓
Gokmenoglu et al. (2019)	China	1971-2014	ARDL	CO ₂ GDP, EC, AGRV	Agriculture →CO ₂ (+)	✓
Qiao et al. (2019)	G20	1990-2014	Johansen-Fisher panel cointegration, FMOLS, DOLS	CO ₂ GDP, REC, AGRV	Agriculture →CO ₂ (+)	✓
Zhang et al. (2019)	China	1996-2015	ARDL	CO ₂ GDP, EC, AGRV	Agriculture →CO ₂ (-)	✓
Aydoğan and Vardar (2020)	E7	1990-2014	Pedroni cointegration, OLS, FMOLS and DOLS	CO ₂ GDP, REC, NREC AGRV	Agriculture →CO ₂ (+)	✓
Aziz at al. (2020)	Pakistan	1990-2018	Quantile ARDL	EF GDP, FA, REC, AGRV	Agriculture →EF (-)	✓
Prastiyo et al. (2020)	Indonesia	1970-2015	ARDL	CO ₂ GDP, IND, URB, AGRR	Agriculture →CO ₂ (-)	✓
Ridzuan et al. (2020)	Malaysia	1978-2016	ARDL	CO ₂ GDP, HG, URB, CP, FP, LP	CP and FP →CO ₂ (-)	✓

Note: ARDL: Autoregressive distributed lag model. MOB: mobile use. ELC: electricity consumption. TO: Trade openness. REC: Renewable energy consumption. NREC: non-renewable EC. EF: Ecological footprint. FA: Forest area. HG: hydroelectricity generation. CP: Crop production. FP: Fisheries production. LP: Livestock gross production. AGRV: Agricultural value-added. AGRR: Agricultural production (% of GDP). OLS: Ordinary least squares. CCR: Canonical cointegrating regression. DOLS: Dynamic OLS. IND: Industrialization. URB: Urbanization. FMOLS: Fully modified OLS
Source: own processing

Table 2: Literature review on the agriculture induced EKC hypothesis.

have found that agriculture accelerates CO₂ emissions. In contrast, Liu et al. (2017), Zhang et al. (2019), Aziz at al. (2020), Prastiyo et al. (2020), and Ridzuan et al. (2020) claimed that agriculture reduces environmental pollution and that increasing agricultural production helps to improve environmental quality. In terms of methodology, four out of the 13 studies used time series methods. When using panel data methods, Liu et al. (2017), Balsalobre-Lorente et al. (2019), Qiao et al. (2019), Aydoğan and Vardar (2020) neglected the effects of cross-sectional dependence

(CSD) and homogeneity. Ignoring CSD and slope homogeneity in panel data analysis may lead to biased results (Breitung, 2005). In summary, there are two research gaps in the existing literature on the agricultural induced EKC hypothesis. i) Previous studies in the literature neglect CSD and homogeneity. ii) It is unclear whether the impact of agriculture on the environment is positive or negative. To address these research gaps, we investigated the impact of agriculture on CO₂ emissions in terms of both its GDP share and value-added. In this way, we aimed to obtain

more robust findings and contribute to the current literature.

Materials and methods

Research data and model

To analyze the existence of the agricultural-induced EKC hypothesis in T10AGR countries, this study employs panel data from 1997 to 2014. Since the United States agricultural value-added data is available from 1997, and the data from EC for Nigeria is up to 2016, the period of analysis is limited to 20 observations for each country. Following Gokmenoglu and Taspinar (2018), Dogan (2019), and Qiao et al. (2019), we use Eqs. (1) and (2) to estimate the impact of agricultural value-added, EC, and economic growth on CO₂ emissions.

$$\ln CO_{2,it} = \delta_0 + \delta_1 \ln GDP_{i,t} + \delta_2 \ln GDPSQ_{i,t} + \delta_3 \ln AGRV_{i,t} + \delta_4 \ln EC_{i,t} + e_t \quad (1)$$

$$\ln CO_{2,it} = \delta_0 + \delta_1 \ln GDP_{i,t} + \delta_2 \ln GDPSQ_{i,t} + \delta_3 \ln AGRV_{i,t} + \delta_4 \ln EC_{i,t} + v_t \quad (2)$$

where i denotes cross-sections, δ_0 is the constant term, δ_1 , δ_2 , δ_3 , and δ_4 show the long-term coefficients, and e_t and v_t illustrate the error terms. In addition, $\ln CO_{2,it}$, $\ln GDP_{i,t}$, $\ln GDPSQ_{i,t}$, $\ln AGRV_{i,t}$, $\ln EC_{i,t}$ are logarithmic forms of per capita carbon dioxide emissions (gigatonnes), per capita gross domestic product (constant 2010 US Dollars), squared gross domestic product, per capita agricultural value-added (constant 2010 US Dollars), agricultural value added (% of GDP), and per capita energy consumption (kilowatt-hours), respectively. The variables were sourced from three different sources. On the one hand, the data for CO₂ emissions was originated from Global Carbon Project (2020), and the data for EC was derived from Our World in Data (2020). On the other hand, the data for GDP, AGRV and AGRV were obtained from World Development Indicators (World Bank, 2020). In the Equations, the agricultural-induced EKC hypothesis holds if $\delta_1 > 0$, $\delta_2 < 0$, and both coefficients are statistically significant. In all other cases, there is no inverted U-shaped relationship between economic growth and environmental pollution.

Estimation method

This study first investigates the existence of CSD among cross sections by using the Lagrange multiplier (LM) test of Breusch and Pagan (1980) and CD test Pesaran (2015). Along with examining

the CSD, the study also performs delta ($\tilde{\Delta}$) and adjusted delta ($\tilde{\Delta}_{adj}$) tests developed by Pesaran and Yamagata (2008) to check for slope heterogeneity. In the LM and CD tests, the null hypothesis of no CSD is tested the alternative hypothesis of CSD. While the null hypothesis of the LM test shows that there is no CSD, the null hypothesis of the CD test implies that there is a weak CSD and this dependency can be eliminated when T and N increase. The alternative hypothesis of both tests demonstrates that there is a strong correlation between the cross-sections. In the delta and adjusted delta tests, the null hypothesis of slope homogeneity $H_0: \delta_i = \delta$ is tested against the alternative hypothesis of slope heterogeneity $H_{alternative}: \delta_i \neq \delta_j$. Delta tests have good power properties when $T > N$.

Eberhardt and Bond (2009) and Eberhardt and Teal (2010) developed the augmented mean group (AMG) estimator that takes into account CSD. A second advantage is that no pre-tests such as unit root and cointegration are required to apply the AMG estimator (Destek, 2017; Destek and Sarkodie, 2019). The AMG estimator uses a two-step method to estimate unobservable common effects and includes the common dynamic impact parameter. In the first step of this method, Equation (3) is estimated with time dummies.

$$\Delta CO_{2,it} = \sigma_0 \Delta GDP_{it} + \sigma_1 \Delta GDP_{it}^2 + \sigma_2 \Delta AGRV_{it} | \Delta AGRV_{it} + \sigma_3 \Delta EC_{it} + \sum_{t=2}^T h_t \Delta D_t + z_{it} \quad (3)$$

where Δ is the difference operator, D is the dummy variables, $h_t = \hat{\mu}_t \Delta CO_{2,it}$ denotes the period of the dummies, z_{it} indicates the error term. In the second step, Equation 4 is calculated by converting the estimated h_t to $\hat{\mu}_t$.

$$\Delta CO_{2,it} = \sigma_0 \Delta GDP_{it} + \sigma_1 \Delta GDP_{it}^2 + \sigma_2 \Delta AGRV_{it} | \Delta AGRV_{it} + \sigma_3 \Delta EC_{it} + d_i \hat{\mu}_t + z_{it}, \quad AMG = N^{-1} \sum_{i=1}^N \tilde{\sigma}_i \quad (4)$$

At this stage, $\hat{\mu}_t$ is included in each of the regressions, and finally, the coefficient of the relevant variable can be calculated for each cross-section.

Results and discussion

In the first stage of the analysis, we explore the data properties. Table 3 presents basic descriptive statistics of the series used

Variables	lnCO ₂	lnGDP	lnAGRV	lnAGRR	lnEC
Mean	1.162	8.799	6.132	1.937	9.537
Median	1.232	8.836	6.196	2.198	9.666
Maximum	3.058	10.871	7.076	3.609	11.449
Minimum	-1.125	6.588	5.134	-0.066	7.146
Std. Dev.	0.980	1.212	0.395	1.017	1.046
Skewness	0.095	0.268	-0.490	-0.728	-0.119
Kurtosis	2.504	2.081	3.209	2.379	2.539
Jarque-Bera	2.347	9.424	8.371	20.911	2.238
Probability	0.309	0.008	0.015	0.000	0.326
Sum	232.428	1759.945	1226.468	387.557	1907.445
Sum Sq. Dev.	191.339	292.393	31.101	205.886	218.095
Observations	200	200	200	200	200

Source: own processing

Table 3: Descriptive statistics.

in the analysis. Among the series, lnCO₂, lnEC, and lnAGRR have the highest standard deviation. All series exhibits positive averages, while lnCO₂ and lnAGRR data contain negative values. Moreover, lnCO₂ and lnGDP display a long right tail, whereas lnAGRV, lnAGRR and lnEC are negatively skewed.

In the second stage of the analysis, we perform CSD and homogeneity tests. The results in Table 4 demonstrate that the null hypotheses for cross-sectional independence and homogeneity are rejected. This shows that agricultural countries interact with each other, and any external shock can have an impact on another country. In addition, the null hypothesis of slope homogeneity is rejected at the 1% significance level. Since panel data are heterogeneous and cross-sectionally dependent, the first-generation panel data estimators may produce biased results. Therefore, to obtain reliable findings, second-generation panel methods that account for CSD and heterogeneity should be used.

CSD	Test statistics	p-value
LM	331.341***	0.000
CD	52.526***	0.000
Slope homogeneity	Test statistics	p-value
$\hat{\Delta}$	6.387***	0.000
$\hat{\Delta}_{adj}$	4.447***	0.000

Note: *** indicates the rejection of the null hypothesis at 1% significance level

Source: own processing

Table 4: CSD and homogeneity tests results.

In the third stage of the analysis, we employ the AMG estimator because it does not require leading tests such as cointegration and unit root, and also takes into account CSD and heterogeneity.

Table 5 presents the findings of the AMG estimation for the AGRV model. The results show that EC has a positive impact on CO₂ emissions and the agricultural induced EKC hypothesis is not valid for the whole panel. However, with respect to the country-specific results, we conclude that the agriculture-induced EKC hypothesis is valid in five out of ten countries. In addition, the results show that an increase in agricultural value added reduced environmental pollution in Indonesia, Turkey, and Argentina.

With respect to the AGRR model, the long-term results are given in Table 6. As expected, EC has a statistically significant and positive impact on CO₂ emissions. As in the AGRV model, the agricultural induced EKC hypothesis does not hold for the entire panel, but looking at the country-specific results, we conclude that the hypothesis holds for the United States, Turkey, Argentina, and Thailand. Moreover, agriculture plays an important role in reducing emissions in Nigeria, the United States, and Turkey. Therefore, it can be concluded that agricultural production in the three countries is carried out with environmentally friendly technologies. Regarding EC, a positive relationship with environmental degradation is found in China, India, Brazil, the United States, Japan, Turkey, Argentina, and Thailand.

Countries	lnGDP	lnGDP2	lnAGR	lnEC	A-EKC
China	-2.436*** [1.491]	0.125*** [0.952]	0.464 [0.308]	1.271*** [0.154]	U-shaped
India	-3.367 [2.287]	0.24 [0.162]	0.264 [0.340]	1.028*** [0.293]	X
Indonesia	18.826** [9.179]	-1.147** [0.646]	-0.237** [0.193]	0.277 [0.314]	✓
Brazil	-16.549 [19.988]	0.827 [1.095]	0.043 [0.102]	2.522*** [0.397]	X
United States	30.590** [14.178]	-1.422** [0.660]	0.005 [0.249]	1.396*** [0.070]	✓
Nigeria	61.352*** [22.99]	-4.016*** [1.517]	-0.409 [0.436]	0.432 [0.288]	✓
Turkey	7.224** [3.443]	-0.392** [0.183]	-0.742** [0.044]	0.882*** [0.189]	✓
Japan	-44.738 [53.053]	2.126 [12.346]	0.096 [0.152]	0.082 [0.170]	X
Argentina	28.336*** [8.160]	-1.529*** [0.450]	-0.057** [0.067]	0.275** [0.356]	✓
Thailand	2.399 [4.531]	-0.135 [0.273]	0.409 [0.061]	0.557** [0.282]	X
Panel	1.424 [8.048]	-0.104 [0.411]	0.096 [0.067]	0.757*** [0.169]	X

Note: *** and ** indicate statistical significance at 1% and 5% levels, respectively. The values in brackets represent standard errors
Source: own processing

Table 5: AMG results for per capita agricultural value added (constant 2010 US \$).

Countries	lnGDP	lnGDP2	lnAGR	lnEC	A-EKC
China	-1.158 [1.894]	-0.765 [0.104]	0.484 [0.307]	1.225*** [0.159]	X
India	-1.224 [1.748]	0.103 [0.115]	0.202 [0.132]	0.941*** [0.202]	X
Indonesia	15.721 [11.129]	-0.918 [0.702]	0.13 [0.359]	0.13 [0.359]	X
Brazil	-38.879** [21.052]	2.078** [1.160]	0.084 [0.094]	1.598*** [0.571]	U-shaped
United States	23.215* [28.626]	-0.995* [1.235]	-0.251* [0.124]	1.011** [0.826]	✓
Nigeria	-41.621** [20.744]	1.942** [0.997]	-0.133* [0.051]	1.165 [0.130]	U-shaped
Turkey	9.943*** [11.712]	-3.016*** [2.517]	-0.231*** [0.153]	0.721* [0.346]	✓
Japan	-126.759 [143.971]	-5.965 [6.723]	0.058 [0.110]	0.463* [0.157]	X
Argentina	28.136* [8.990]	-1.517* [0.495]	0.03 [0.039]	0.491** [0.278]	✓
Thailand	2.346** [4.231]	-0.433** [0.216]	0.027 [0.073]	0.346** [0.326]	✓
Panel	1.521 [8.037]	-0.102 [0.399]	0.043 [0.067]	0.853*** [0.235]	X

See notes for Table 5
Source: own processing

Table 6: AMG estimation results for agricultural value added (% of GDP)

In the next stage, the long-term findings of the two models are comparatively summarized in Table 7. As can be seen in the table, the validity of the EKC hypothesis varies for Indonesia, Nigeria, and Thailand, depending on the agricultural indicator. At the same time, the difference of variables affects the significance of coefficients of agriculture in the United States, Nigeria, Indonesia, and Argentina, and EC in Japan. Therefore, it can be said that researchers should carefully examine the impact of AGRR and AGRV on the environmental indicators.

Considering the two models, the EKC hypothesis can be verified in Indonesia, Nigeria, the United States, Turkey, Argentina, and Thailand. The validity of the EKC hypothesis is in line with the results of Gokmenoglu and Taspinar (2018), Agboola and Bekun (2019), Balsalobre-Lorente et al. (2019), Dogan (2019), Gokmenoglu et al. (2019), Qiao et al. (2019), Zhang et al. (2019), Aydoğan and Vardar (2020), Aziz et al. (2020), Prastiyo et al. (2020), and Ridzuan et al. (2020). However, it is contrary to the findings of Ben Jebli and Ben Youssef (2017) and Liu et al. (2017). According to Pata (2018b), pollution can be reduced above a certain income level by increasing environmental awareness and energy use efficiency. Although economic development initially leads to environmental degradation in the six out of the ten countries, this situation reverses over time and the quality of the environment improves due to rising income. However, China, India and Japan, where the EKC hypothesis is not valid, are among the highest CO₂ emitters in the world. The failure of the EKC hypothesis may be due to the ineffective implementation

of environmental laws and measures in these three countries and Brazil.

The coefficient of EC is positive and statistically significant in eight of the ten countries, except Indonesia and Japan. This result is similar to that of Gokmenoglu and Taspinar (2018), Agboola and Bekun (2019), Dogan (2019), Gokmenoglu et al. (2019), Zhang et al. (2019), and Pata (2021). EC is closely related to GHGs, which is a serious problem for developing countries (Abdallah, 2013). According to World Bank (2020), in 2014, fossil fuels accounted for 93% of total EC in Japan, 87% in China and Argentina, 73% in India, 79% in Thailand, 59% in Brazil, 83% in the United States, and 89% in Turkey. The use of fossil fuels, such as oil and coal, is the largest contributor to the increase in CO₂ emissions (Lotfalipour et al., 2010; Saboori and Sulaiman, 2013). Therefore, for a better environment, the share of fossil fuels in total energy should be reduced in the eight countries included in the T10AGR.

Finally, agricultural production is a solution to the environmental problems in Indonesia, Turkey, Nigeria, Argentina, and the United States. In these countries, production in the industrial sector increases environmental pollution more than in the agricultural sector. As Rafiq et al. (2016) noted, although the industrial sector increases environmental pollution, agriculture and the service sector could mitigate environmental degradation. Therefore, reducing the share of the industrial sector in GDP in the United States, Nigeria and Turkey and increasing the agricultural sector can have a positive impact on improving environmental quality. Contrary to the common findings that

Countries	AGRR model			AGRV model		
	Energy	Agriculture	A-EKC	Energy	Agriculture	A-EKC
China	Positive	–	–	Positive	–	U-shaped
India	Positive	–	–	Positive	–	–
Indonesia	–	–	–	–	Negative	Valid
Brazil	Positive	–	U-shaped	Positive	–	–
United States	Positive	Negative	Valid	Positive	–	Valid
Nigeria	–	Negative	U-shaped	–	–	Valid
Turkey	Positive	Negative	Valid	Positive	Negative	Valid
Japan	Positive	–	–	–	–	–
Argentina	Positive	–	Valid	Positive	Negative	Valid
Thailand	Positive	–	Valid	Positive	–	–

Source: own processing

Table 7: Summary of the long-run estimation.

agriculture increases environmental pollution, our results are in line with the findings of Liu et al. (2017), Zhang et al. (2019), Aziz et al. (2020), Prastiyo et al. (2020) and Ridzuan et al. (2020) who claimed that agriculture reduces environmental degradation. Agriculture plays a crucial role in the food supply and consumption chain. With the COVID-19 pandemic, the importance of agricultural production has become more evident than ever. In this context, the reduction of CO₂ emissions and sustainable food supply can be achieved through modern agricultural practices.

Conclusion

This study aimed to investigate the impact of agriculture, EC, and GDP on CO₂ emissions using a panel of T10AGR countries under the agricultural EKC hypothesis. In performing this task, we used the AMG panel estimation method and found an inverted U-shaped EKC relationship between per capita GDP and per capita CO₂ emissions in six out of the ten countries. This finding shows that the increase in the income level of Argentina, Indonesia, Nigeria, Thailand, Turkey, and the United States will lead to a decrease in environmental pollution above a certain threshold. However, the EKC hypothesis is not valid in Brazil, China, India, and Japan. The rising income level in these four countries is not a solution to environmental pollution. Another finding of the study is that more EC stimulates CO₂ emissions, while agricultural activities help to improve the environment. Based on these findings, we provide substantive policy recommendations related to emission reduction.

As the agricultural sector is responsible for 1/5 of global GHGs, it has an important responsibility in reducing climate change. FAO (2016) in its report stated that agricultural CO₂ emissions are caused by conversion of forests to pasture or cropland and land degradation associated with overgrazing. At the same time, the production of chemicals used

in agriculture and the use of fossil energy on farms and in fields contribute significantly to the increase in GHGs. All of these problems can be reduced through better farming management practices.

In order to reduce environmental degradation and ensure sustainable agriculture, the widespread use of synthetic fertilizers should be avoided, and organic farming should be promoted. To mitigate CO₂ emissions, measures can be implemented to improve irrigation systems in rice cultivation and to increase efficiency in energy use. In addition, the governments of T10AGR countries can allocate additional funds for agricultural research and development expenditures to reduce environmental pollution. Besides, as fossil fuels used in agricultural activities increase environmental pressure, decision-makers in these countries need to support the use of renewable energy in the transportation and retail stages of agricultural products. It is possible to significantly reduce agricultural CO₂ emissions by replacing fossil fuels with renewable energy types such as wind, solar, and hydropower. Furthermore, governments and companies can organize awareness-raising and supportive training programs for farmers on organic farming, conscious production, and renewable energy use. Companies that consume large amounts of agricultural raw materials should be provided with subsidies and tax exemptions for the use of green energy sources in agricultural activities. All these policies will help reduce environmental pollution and achieve the goals of SDG.

Finally, more climate finance and agricultural investment is needed to facilitate the transition to sustainable agricultural practices. However, available funding for agricultural investments falls far short of the need (FAO, 2016). Therefore, the funds that will provide climate finance should be established as soon as possible by institutions, organizations, and governments.

Corresponding authors

Ugur Korkut Pata

Department of Economics, Osmaniye Korkut Ata University

80000 Merkez/Osmaniye, Turkey

E-mail: korkutpata@ktu.edu.tr; korkutpata@osmaniye.edu.tr

References

- [1] Abdallah, K. B., Belloumi, M. and De Wolf, D. (2013) "Indicators for sustainable energy development: A multivariate cointegration and causality analysis from Tunisian road transport sector", *Renewable and Sustainable Energy Reviews*, Vol. 25, pp. 34-43. ISSN 1364-0321. DOI 10.1016/j.rser.2013.03.066.
- [2] Agboola, M. O. and Bekun, F. V. (2019) "Does agricultural value added induce environmental degradation? Empirical evidence from an agrarian country", *Environmental Science and Pollution Research*, Vol. 26, No. 27, pp. 27660-27676. E-ISSN 1614-7499, ISSN 0944-1344. DOI 10.1007/s11356-019-05943-z.
- [3] Ali, S., Liu, Y., Ishaq, M., Shah, T., Abdullah Ilyas, A. and Din, I. U. (2017) "Climate change and its impact on the yield of major food crops: evidence from Pakistan", *Foods*, Vol. 6, No. 6, pp. 1-19. E-ISSN 2304-8158. DOI 10.3390/foods6060039.
- [4] Aydoğan, B. and Vardar, G. (2020) "Evaluating the role of renewable energy, economic growth and agriculture on CO₂ emission in E7 countries", *International Journal of Sustainable Energy*, Vol. 39, No. 4, pp. 335-348. E-ISSN 1478-646X, ISSN 1478-6451. DOI 10.1080/14786451.2019.1686380.
- [5] Aziz, N., Sharif, A., Raza, A. and Rong, K. (2020) "Revisiting the role of forestry, agriculture, and renewable energy in testing environment Kuznets curve in Pakistan: evidence from Quantile ARDL approach", *Environmental Science and Pollution Research*, Vol. 27, pp. 10115-10128. E-ISSN 1614-7499, ISSN 0944-1344. DOI 10.1007/s11356-020-07798-1.
- [6] Balsalobre-Lorente, D., Driha, O. M, Bekun, F. V. and Osundina, A. O. (2019) "Do agricultural activities induce carbon emissions? The BRICS experience", *Environmental Science and Pollution Research*, Vol. 26, No. 24, pp. 25218-25234. E-ISSN 1614-7499, ISSN 0944-1344. DOI 10.1007/s11356-019-05737-3.
- [7] Breusch, T. S. and Pagan, A. R. (1980) "The Lagrange multiplier test and its applications to model specification in econometrics", *The Review of Economic Studies*, Vol. 47, No. 1, pp. 239-253. E-ISSN 1467-937X, ISSN 0034-6527. DOI 10.2307/2297111.
- [8] Breitung, J. (2005) "A parametric approach to the estimation of cointegration vectors in panel data", *Econometric Reviews*, Vol. 24, No. 2, pp. 151-173. E-ISSN 1532-4168, ISSN 0747-4938. DOI 10.1081/ETC-200067895.
- [9] Chel, A. and Kaushik, G. (2011) "Renewable energy for sustainable agriculture", *Agronomy for Sustainable Development*, Vol. 31, No. 1, pp. 91-118. E-ISSN 1773-0155, ISSN 1774-0746. DOI 10.1051/agro/2010029.
- [10] Cherni, A. and Jouini, S. E. (2017) "An ARDL approach to the CO₂ emissions, renewable energy and economic growth nexus: Tunisian evidence", *International Journal of Hydrogen Energy*, Vol. 42, No. 48, pp. 29056-29066. ISSN 0360-3199. DOI 10.1016/j.ijhydene.2017.08.072.
- [11] Destek, M. A. and Sarkodie, S. A. (2019) "Investigation of environmental Kuznets curve for ecological footprint: the role of energy and financial development", *Science of the Total Environment*, Vol. 650, pp. 2483-2489. ISSN 0048-9697. DOI 10.1016/j.scitotenv.2018.10.017.
- [12] Destek, M. A. (2017) "Biomass energy consumption and economic growth: evidence from top 10 biomass consumer countries", *Energy Sources, Part B: Economics, Planning, and Policy*, Vol. 12, No. 10, pp. 853-858. E-ISSN 1556-7257, ISSN 1556-7249. DOI 10.1080/15567249.2017.1314393.
- [13] Dogan, N. (2019) "The impact of agriculture on CO₂ emissions in China", *Panoeconomicus*, Vol. 66, No. 2, pp. 257-271. E-ISSN 2217-2386, ISSN 1452-595X. DOI 10.2298/PAN160504030D.
- [14] Eberhardt, M. and Bond, S. (2009) "Cross-section dependence in nonstationary panel models: a novel estimator". MPRA Paper 17692, pp. 1-26.
- [15] Eberhardt, M. and Teal, F. (2010) "Productivity analysis in global manufacturing production. Economics Series", Working Papers, 515. University of Oxford, Department of Economics.

- [16] FAO (2016) "*The State of Food and Agriculture Climate Change, Agriculture and Food Security*" Rome. [Online]. Available: <http://www.fao.org/3/a-i6030e.pdf> [Accessed: 2 Sept. 2020].
- [17] Global Carbon Project (2020) "*Supplemental data of Global Carbon Budget 2020 (Version 1.0)*". [Online]. Available: <https://folk.universitetetioslo.no/roberan/GCB2020.shtml> [Accessed: 24 March 2021].
- [18] Gokmenoglu, K. K. and Taspinar N. (2018) "Testing the agriculture-induced EKC hypothesis: the case of Pakistan", *Environmental Science and Pollution Research*, Vol. 25, No. 23, pp. 22829-22841. E-ISSN 1614-7499, ISSN 0944-1344. DOI 10.1007/s11356-018-2330-6.
- [19] Gokmenoglu, K. K., Taspinar, N. and Kaakeh, M. (2019) "Agriculture-induced environmental Kuznets curve: the case of China", *Environmental Science and Pollution Research*, Vol. 26, No. 36, pp. 37137–37151. E-ISSN: 1614-7499, ISSN: 0944-1344. DOI 10.1007/s11356-019-06685-8.
- [20] Grossman, G. M. and Krueger, A. B. (1991) "Environmental impacts of a North American free trade agreement", NBER working papers, 3914. National Bureau of Economic Research. DOI 10.3386/w3914.
- [21] Holtz-Eakin, D. and Selden, T. M. (1995) "Stoking the fires? CO₂ emissions and economic growth", *Journal of Public Economics*, Vol. 57, No. 1, pp. 85-101. ISSN 0047-2727. DOI 10.1016/0047-2727(94)01449-X.
- [22] IPCC (2013) "*Climate Change 2013 The Physical Science Basis*", [Online]. Available: https://www.ipcc.ch/site/assets/uploads/2018/03/WG1AR5_SummaryVolume_FINAL.pdf [Accessed: 10 Sept. 2020].
- [23] IPCC (2014) "*Working Group III Contribution to the IPCC Fifth Assessment Report of the Intergovernmental Panel on Climate Change*", [Online]. Available: https://www.ipcc.ch/site/assets/uploads/2018/02/ipcc_wg3_ar5_full.pdf [Accessed: 27 Oct. 2020].
- [24] Jebli, M. B. and Youssef, S. B. (2017) "Renewable energy consumption and agriculture: evidence for cointegration and Granger causality for Tunisian economy", *International Journal of Sustainable Development & World Ecology*, Vol. 24, No. 2, pp. 149-158. ISSN 1350-4509, E-ISSN 1745-2627. DOI 10.1080/13504509.2016.1196467.
- [25] Lotfalipour, M. R., Falahi, M. A. and Ashena, M. (2010) "Economic growth, CO₂ emissions, and fossil fuels consumption in Iran", *Energy*, Vol. 35, No. 12, pp. 5115-5120. ISSN 0360-5442. DOI 10.1016/j.energy.2010.08.004.
- [26] Liu, X., Zhang, S. and Bae, J. (2017) "The impact of renewable energy and agriculture on carbon dioxide emissions: Investigating the environmental Kuznets curve in four selected ASEAN countries", *Journal of Cleaner Production*, Vol. 164, pp. 1239-1247. ISSN 0959-6526. DOI 10.1016/j.jclepro.2017.07.086.
- [27] Mahmood, N., Wang, Z. and Hassan, S. T. (2019) "Renewable energy, economic growth, human capital, and CO₂ emission: an empirical analysis", *Environmental Science and Pollution Research*, Vol. 26, No. 20, pp. 20619-20630. E-ISSN 1614-7499, ISSN 0944-1344. DOI 10.1007/s11356-019-05387-5.
- [28] Muller, A., Jawtusich, J. and Gattinger, A. (2011) "*Mitigating greenhouse gases in agriculture: a challenge and opportunity for agricultural policies*", Diakonisches Werk der EKD e.v. for Brot für die Welt Staffenbergstrabe 76 D-70184 Stuttgart Germany. [Online]. Available: <http://orgprints.org/19989/1/gatti.pdf> [Accessed: 10 Sept. 2020].
- [29] Our World in Data (2019) "*Primary energy consumption*". [Online]. Available: <https://ourworldindata.org/grapher/primary-energy-cons?tab=chart> [Accessed: 25 March 2021].
- [30] Our World in Data (2020) "*Energy use per person*". [Online]. Available: <https://ourworldindata.org/grapher/per-capita-energy-use>. [Accessed: 24 March 2021].

- [31] Paramati, S. R., Mo, D. and Gupta, R. (2017) "The effects of stock market growth and renewable energy use on CO₂ emissions: evidence from G20 countries", *Energy Economics*, Vol. 66, pp. 360–371. ISSN 0140-9883. DOI 10.1016/j.eneco.2017.06.025.
- [32] Pata, U. K. (2018a) "The effect of urbanization and industrialization on carbon emissions in Turkey: evidence from ARDL bounds testing procedure", *Environmental Science and Pollution Research*, Vol. 25, No. 8, pp. 7740-7747. E-ISSN 1614-7499, ISSN 0944-1344. DOI 10.1007/s11356-017-1088-6.
- [33] Pata, U. K. (2018b) "The influence of coal and noncarbohydrate energy consumption on CO₂ emissions: revisiting the environmental Kuznets curve hypothesis for Turkey", *Energy*, Vol. 160, pp. 1115-1123. ISSN 0360-5442. DOI 10.1016/j.energy.2018.07.095.
- [34] Pata, U. K. (2021) "Renewable and non-renewable energy consumption, economic complexity, CO₂ emissions, and ecological footprint in the USA: testing the EKC hypothesis with a structural break", *Environmental Science and Pollution Research*, Vol. 28, pp. 846-861. E-ISSN 1614-7499, ISSN 0944-1344. DOI 10.1007/s11356-020-10446-3.
- [35] Pesaran, M. H. (2015) "Testing weak cross-sectional dependence in large panels", *Econometric Reviews*, Vol. 34, No. 6, pp. 1089-1117. E-ISSN 1532-4168, ISSN 0747-4938. DOI 10.1080/07474938.2014.956623.
- [36] Pesaran, M. H. and Yamagata, T. (2008) "Testing slope homogeneity in large panels", *Journal of Econometrics*, Vol. 142, No. 1, pp. 50-93. ISSN 0304-4076, DOI 10.1016/j.jeconom.2007.05.010.
- [37] Prastiyo, S. E. and Hardyastuti, S. (2020) "How agriculture, manufacture, and urbanization induced carbon emission? The case of Indonesia", *Environmental Science and Pollution Research*, Vol. 27, pp. 42092-42103. E-ISSN 1614-7499, ISSN 0944-1344. DOI 10.1007/s11356-020-10148-w.
- [38] Qiao, H., Zheng, F., Jiang, H. and Dong, K. (2019) "The greenhouse effect of the agriculture-economic growth-renewable energy nexus: Evidence from G20 countries", *Science of the Total Environment*, Vol. 671, pp. 722-731. ISSN 0048-9697. DOI 10.1016/j.scitotenv.2019.03.336.
- [39] Rafiq, S., Salim, R. and Apergis, N. (2016) "Agriculture, trade openness and emissions: an empirical analysis and policy options", *Australian Journal of Agricultural and Resource Economics*, Vol. 60, No. 3, pp. 348-365. E-ISSN 1467-8489. DOI 10.1111/1467-8489.12131.
- [40] Ridzuan, N. H. A. M., Marwan, N. F., Khalid, N., Ali, M. H. and Tseng, M. L. (2020) "Effects of agriculture, renewable energy, and economic growth on carbon dioxide emissions: Evidence of the environmental Kuznets curve", *Resources, Conservation and Recycling*, Vol. 160, ISSN 0921-3449. DOI 10.1016/j.resconrec.2020.104879.
- [41] Sarkodie, S. and Owusu, P. A. (2017) "The causal nexus between carbon dioxide emissions and agricultural ecosystem - an econometric approach", *Environmental Science and Pollution Research*, Vol. 24, No. 2, pp. 1608-1618. E-ISSN 1614-7499, ISSN 0944-1344. DOI 10.1007/s11356-016-7908-2.
- [42] Selden, T. M. and Song, D. (1994) "Environmental quality and development: is there a Kuznets curve for air pollution emissions?", *Journal of Environmental Economics and Management*, Vol. 27, No. 2, pp. 147-162. ISSN 0095-0696. DOI 10.1006/jeeem.1994.1031.
- [43] Shafik, N. and Bandyopadhyay, S. (1992) "Economic growth and environmental quality: time-series and cross-country evidence", Vol. 904. Policy Research Working Paper, World Bank Publications.
- [44] Shafik, N. (1994) "Economic development and environmental quality: an econometric analysis", *Oxford Economic Papers*, Vol. 45, No. 1, pp. 757-773. E-ISSN 1464-3812, ISSN 0030-7653. DOI 10.1093/oep/46.Supplement_1.757.
- [45] Timmer, P. C. (2009) "Agricultural trade policy during structural transformation". In: Sarris, A. and Morrison, J. (eds) *The evolving structure of world agricultural trade Implications for trade policy and trade agreements*. FAO, Rome. [Online]. Available: http://www.indiaenvironmentportal.org.in/files/FINAL_PDF_EVOLVING_WITH_COVER_LOW_RES.pdf#page=55 [Accessed: 12 Sept. 2020].

- [46] Ullah, A., Khan, D., Khan, I. and Zheng, S. (2018) "Does agricultural ecosystem cause environmental pollution in Pakistan? Promise and menace", *Environmental Science and Pollution Research*, Vol. 25, No. 14, pp. 13938-13955. E-ISSN 1614-7499, ISSN 0944-1344. DOI 10.1007/s11356-018-1530-4.
- [47] World Bank (2020) "*World development indicators*". [Online]. Available: <https://databank.worldbank.org/source/world-development-indicators> [Accessed: 2 Sept. 2020].
- [48] Yilanci, V. and Pata, U. K. (2020) "Investigating the EKC hypothesis for China: the role of economic complexity on ecological footprint", *Environmental Science and Pollution Research*, Vol. 27, pp. 32683-32694. E-ISSN 1614-7499, ISSN 0944-1344. DOI 10.1007/s11356-020-09434-4.
- [49] Zhang, L., Pang, J., Chen, X. and Lu, Z. (2019) "Carbon emissions, energy consumption and economic growth: Evidence from the agricultural sector of China's main grain-producing areas", *Science of the Total Environment*, Vol. 665, pp. 1017-1025. ISSN 0048-9697. DOI 10.1016/j.scitotenv.2019.02.162.

Analysis of Deviations – the Role of Controlling in Small and Medium Sized Agricultural Enterprises

Eudmila Dobošová, Daniela Hupková, Petronela Švikruhová, Ondrej Beňuš, Ľubomír Gurčík

Faculty of Economics and Management, Slovak University of Agriculture in Nitra, Slovak Republic

Abstract

One of the main tasks of controlling is to identify the deviations of actually achieved results compared to the planned and to find out reasons for their occurrence. Lack of attention to this activity can have negative impact on the company's performance. The paper focuses on identification of selected research results that was conducted in Slovak agricultural enterprises. The main goal of the paper is to evaluate and analyse the approach of agricultural enterprises in Slovakia to the implementation of deviations analysis. The basic technique applied for data collection was a questionnaire survey, which was supplemented by a direct interview with managers of selected agricultural entities. The implementation of the questionnaire survey was preceded by a pre-research (pilot study) carried out in the Czech Republic. Obtained data were statistically examined applying the XLStat statistical program. Based on achieved research results we confirmed presumptions from the theoretical background elaborated in the paper, stating that the analysis of deviations is an integral part of controlling. Furthermore, we identify problematic areas for deviations analysis and also controlling implementation in agricultural enterprises in Slovakia.

Keywords

Agriculture, agricultural enterprises, analysis of deviations, controlling.

Dobošová, E., Hupková, D., Švikruhová, P., Beňuš, O. and Gurčík, Ľ. (2022) "Analysis of Deviations – the Role of Controlling in Small and Medium Sized Agricultural Enterprises", *AGRIS on-line Papers in Economics and Informatics*, Vol. 14, No. 1, pp. 33-43. ISSN 1804-1930. DOI 10.7160/aol.2022.140103.

Introduction

The aim of business entities is to increase the efficiency of business activities (Váryová et al., 2012). The tool for treating the economic systems is controlling, which allows not only detecting the action of economic and non-economic factors, but also their future development, analysis of deviations from the desired state and prepare corrective actions (Sedliačiková et al., 2015). In addition to financial management and cost accounting, control and analysis of deviations also have a dominant position within controlling tasks (Rautenstrauch and Müller, 2005). The ability to recognize impending current deviations from the plan and their successful removal by the management is the benefit of controlling (Chrenková, 2011). Controlling collects data, reconciles information, checks compliance with plans, identifies deviations and proposes measures (Sósová, 2013). Controlling is a suitable tool for recognizing the impending crisis. It should point out in advance any deviations from the healthy development of the company, reveal the causes, diagnose and promptly determine

how remediation can be achieved (Smejkal and Rais, 2013). Controlling ensures information coordination between managers at all organizational and managerial levels. It builds an information system that integrates useful information for its needs and in accordance with the request (Simić and Mašić, 2013). If controlling wants to maintain an influential function in the company it needs to adapt to changed expectations from management (Laval, 2015).

In this sense, controlling differs from control, because it not only records the detected changes but also evaluates them, proposing changes to improve the company's activities (Serina, 2012). Deviation analysis is a method through causes of deviations and deviation influencing factors can be identified - controllable and uncontrollable (Ganeva, 2020). Operational deviation analysis is centred on monitoring and evaluation real value vs. planned (comparison plan vs. reality) (Dolinayová and Loch, 2015). Access to the right information in the right time is crucial for every subject (Látečková et al., 2018). The analysis of deviations provides information with which the company's

management can then implement qualified decisions (Máče, 2013).

Between the preliminary and final information, we almost always encounter certain deviations, which provide very valuable material for managers. They indicate which areas of the controlled process need to be given increased interest (Hradecký et al., 2008). Deviations assure the necessary flexibility within a company, but also increase possible internal control weaknesses (Swinnen et al., 2012). Either follow-up or continuous detection is used to detect deviations. Subsequent investigation is based on the assessment of compliance with the developed standards comprehensively. It can be only made after exceeding a given point in time. On the other hand, the essence of the continuous detection of deviations, in which the so-called difference methods are used, is their detection directly during the performance of the task (Fibírová and Šoljaková, 2012).

Deviations must be caught in time. As the analysis of deviations is a particularly costly process, it is necessary to address only those deviations that are essential for management. A tolerance limit or significance limit must be predetermined for each monitored quantity (Popesko and Papadaki, 2016). The manager pays more attention to the emergence of a negative deviation from a predetermined plan, although he should focus his attention primarily on the positive deviations that can lead the company towards lasting success. Finding the reasons for positive deviations should be one of the primary tasks of the manager (Lojda, 2011).

Even the most precisely defined and quantified deviation must always be supplemented by the cause of its occurrence, or by determining the responsibility for the occurrence of the deviation and then taking appropriate measures so that its probability is minimized in the future (Scholleová, 2009). A significant benefit is that the emergence of a certain deviation can be directly related to the responsibility and personal goals of the employee or manager. At the same time, however, it is not always possible to objectively assign individual employees responsible for the occurrence of deviations (Petřík, 2005).

Materials and methods

The paper aims to present the results of a research study aimed at mapping the situation in the field of deviations analysis, as one of the main tasks of controlling, within business entities operating in the field of agriculture in Slovakia. The research study was carried out in 2018 based

on qualitative and quantitative research. The object of the research was agricultural enterprises operating in Slovakia, while in the centre of our attention were small and medium-sized enterprises, which occupy a significant share in the agrarian structure of Slovakia. As studies show (Pletnev and Barkhatov, 2016; Yoshino and Taghizadeh-Hesary, 2019; Stanciu, 2014; Mura and Buleca, 2014; Dobrovič, 2015), small and medium-sized enterprises play an important role in the market economy and are an integral part of it. Lesáková (2007) notes that the condition for the survival of SMEs is their ability to react and adapt to change. Many studies (Sedliačiková et al., 2012; Bednárová, 2008) confirm that the biggest barrier that prevents SMEs from applying new approaches is their fear of innovative methods and modernization.

In order to obtain relevant results from the practice of agricultural enterprises, we conducted research using a questionnaire and direct interviews with representatives of selected enterprises. We followed up on the research we carried out in the Czech Republic. We interviewed 20 agricultural entities that participated in the questionnaire survey. In this brief questionnaire survey, we found that:

- agricultural entities in the Czech Republic monitor deviations that arise for them within the scope of their business activities,
- when monitoring deviations, enterprises compare the analysed indicators with indicators from previous periods,
- 80% of surveyed enterprises also deal with the analysis of the causes of deviations,
- the most common cause of deviations is poor planning and incorrect organization.

When creating the target sample of agricultural holdings, we worked with a database provided by the Agricultural Paying Agency. From this database, we created a sample of enterprises by the controlled selection, so that it corresponds to the structure of agricultural enterprises in Slovakia in terms of the legal form of business and size (number of employees). We excluded micro-enterprises from the survey. The companies that formed the sample were represented throughout the territory of the Slovak Republic, so the criterion of location was also met. In order to achieve a higher return on the questionnaires, all agricultural subjects in the sample were contacted by telephone. We contacted a total of 582 agricultural entities with a request to complete the questionnaire in electronic form. After the return of questionnaires and excluding questionnaires that were incorrectly

filled or were filled in by micro-enterprises, we reached the level of 150 correctly completed questionnaire forms from small and medium-sized agricultural entities. Our main goal was to find out whether farms monitor deviations, how they monitor them or look for the causes of their occurrence. That is the most common reason why the results achieved differ from the predetermined plan.

The research study focused on finding answers to the following questions:

- Do you observe deviations when fulfilling the set goals?
- What importance has activity in the company?
- How are deviations monitored in your company?
- Are you researching and looking for the causes of deviations?
- What are the most common causes of deviations in your business?
- In which periods (specifically in which activities) do you evaluate deviations?

The respondents who answered the questions in the questionnaire were company managers (controllers, heads of economic departments, directors). The classification criteria of companies were the size of the farm, the legal form of business, the length of operation of the company on the market and the existence of controlling in the company.

The data obtained from the questionnaire forms were processed in the statistical program Xstat.

In order to further analyse the obtained answers, the Chi-square test was used, which serves to determine the dependence between the studied phenomena. Hypothesis H_0 states that there is no statistically significant dependence between the variables and hypothesis H_1 confirms a significant dependence.

$$\chi^2 = \sum_{j=1}^k \frac{(f_{e,j} - f_{o,j})^2}{f_{o,j}} \quad (1)$$

where: $f_{e,j}$ – empirical number of statistical units*

$f_{o,j}$ – theoretical number of statistical units

k – number of classes

This test can only be used if the condition is met:

$$f_{o,j} \geq 5 \text{ for } j = 1, 2, \dots, k.$$

In addition to the Chi-square test, there is a correspondence map, which is the output of a multidimensional correspondence analysis and which allows assessing categories of a given variable, their interaction and differences between them, or associations with categories of other variables. In order to determine whether the differences found in the sample are statistically significant or may only be the result of coincidence, we used the Friedman test. Hypothesis H_0 represents the equality of order and H_1 confirms the presence of at least one distribution different from the others.

$$\sum_{i=1}^n \sum_{t=1}^k T_{ij} = \frac{nk(k+1)}{2} \quad (2)$$

where: n – number of blocks

k – number of classes

T_{ij} - order

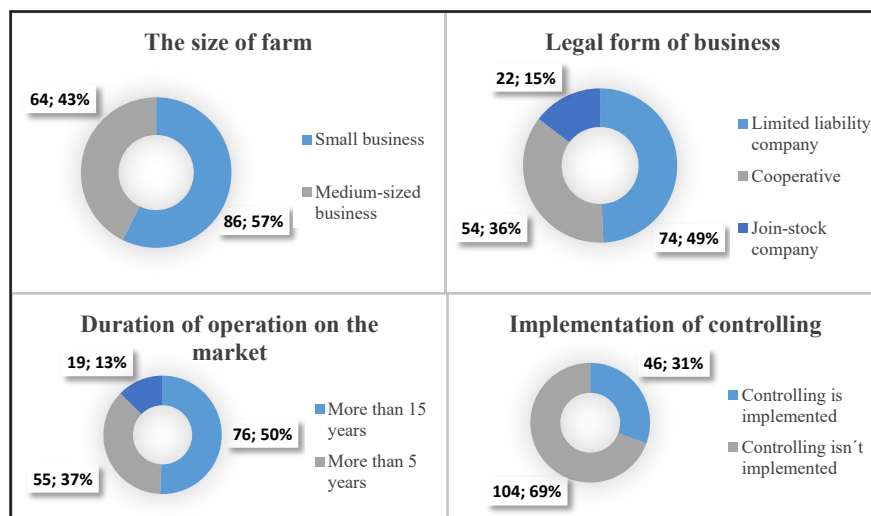

Source: own processing

Figure 1: Structure of the researched enterprises.

If we reject hypothesis H_0 in favour of alternative hypothesis H_1 , which states that treatments do not have the same effect, the unresolved question remains which choices differ statistically significantly from each other. Nemenyi's multiple comparison method is used to compare the differences between the individual files. Asymptotically, the critical values for these multiple comparisons are given by:

$$q_{k,\infty}(\alpha) \sqrt{\frac{1}{12}nk(k+1)} \quad (3)$$

where: $q_{k,\infty}(\alpha)$ - critical range value of the independent random variables with distribution $N(0, 1)$.

Results and discussion

The agricultural sector is an important part of an economy and has its own specifics. Its specificities are primarily of the seasonal nature of production and dependence on natural conditions (Steklá et al., 2015). According to the abovementioned information, agricultural holdings must pay close attention to the analysis of deviations. The analysis of deviations has its

irreplaceable place within the controlling tasks. Its aim is not only to detect possible future deviations, but also to find the cause of their potential occurrence, and thus prevent the occurrence of a given deviation in the future. This means finding the cause of a possible deviation before it occurs. As part of a research study, we found out whether agricultural enterprises in Slovakia monitor the deviations that arise within their entrepreneurial activities. The responses of small and medium-sized agricultural entities vary considerably. While most medium-sized enterprises (72%) companies monitor deviations, in the case of small enterprises it is more or less equal, because only 46 (53%) small enterprises pay attention to the occurrence of deviations. Subsequently, we found out how important these subjects consider the implementation of the activity. On a scale of 0 - 5 (0 - no importance, 5 - the greatest importance) questioned managers had to evaluate the importance of division implementation in the company. The modal value of the respondents' answers (mode = 4) confirms the more than average importance of this activity (Table 1).

In order to further investigate the respondents'

Size of the enterprise	
H_0	There is no statistically significant relationship between company size and deviation tracking
H_1	There is a statistically significant relationship between the size of the company and the monitoring of deviation
Significance of the test (p value)	0.0222
Comparison	$p < 0.05$
Result of the test	Acceptance of H_1
Pearson's correlation coefficient	0.1867
Time on the market	
H_0	There is no statistically significant relationship between the length of a company's presence in the market and the monitoring of deviations
H_1	There is a statistical relationship between the length of a company's presence in the market and the monitoring of deviations
Significance of the test (p value)	0.0005
Comparison	$p < 0.05$
Result of the test	Acceptance of H_1
Pearson's correlation coefficient	0.3192
Legal form of business	
H_0	There is no statistically significant relationship between the legal form of the business and the monitoring of deviations
H_1	There is a statistically significant relationship between the legal form of the business and the monitoring of deviations
Significance of the test (p value)	0.4575
Comparison	$p > 0.05$
Result of the test	Acceptance of H_0

Source: own processing, XLStat

Table 1: Outcome of Chi-quadrat test a Pearson's correlation coefficient.

answers, we performed a Chi-square test to determine the dependence and Pearson's correlation coefficient to determine the strength of the dependence.

The result of the Chi-square test shows that the size of the company has an impact on the monitoring of deviations within observed companies. Therefore, we reject the null hypothesis at the level of significance $\alpha = 0.05$ related to the absence of dependence and accept an alternative hypothesis related to the existence of the enterprise and the size of the enterprise. The coefficient expressing the strength of dependence refers only to a weak dependence. When finding the dependence between the monitoring of deviations in the company and the length of operation on the market, the result of the Chi-square test again showed the same result and confirmed the dependence. We again rejected the null hypothesis of the absence of dependence and accept the alternative hypothesis. The strength of the dependence expressed by the coefficient of dependence ranges from weak to medium. The influence of the last analysed factor, the legal form of business, has not been proven. The chi-square test did not confirm dependence, which means that the null hypothesis that there is no dependence cannot be rejected. Furthermore, we aimed to identify whether there is a dependence between the existence of controlling in the company and the monitoring of deviations. We performed the Chi-square test again.

Since the calculated value of p is lower than the level of significance $\alpha = 0.05$, we reject the null hypothesis and accept an alternative hypothesis that refers to dependence between the existence of controlling in the company and the monitoring of deviations. Pearson's correlation coefficient refers to a medium-strong dependence (Table 2).

In the Figure 2 we show a correspondence map on which the relationship between variables

is visualized. Almost all companies that have implemented controlling also monitor the deviations. This means that answers of the respondents to the two selected questions correspond and confirm that analysis of deviations is one of the main tasks of controlling, as written by Máče (2013), Synek (2011), Dolinayová and Loch (2015) and many others.

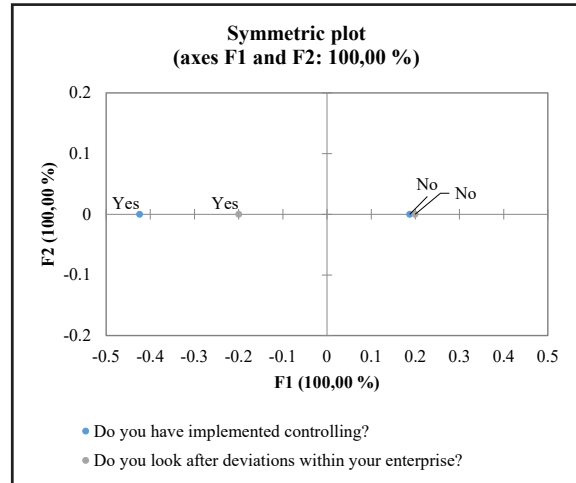

Source: own processing

Figure 2: Correspondence map.

In the next question, we asked respondents who monitor deviations about the system of monitoring. As part of the monitoring of deviations, the actually achieved results are compared with the expected ones. Expected results represent standards that may take the form of planned results or may be in the form of results achieved in previous years. These can be determined in natural or in financial terms.

As shown in Figure 3, investigated the structure of responses when comparing respondents representing small enterprises and respondents representing medium-sized enterprises is very similar. It means that the use of different methods of monitoring deviations in small and medium-sized enterprises is almost identical. Most

H_0	There is no statistically significant relationship between the existence of controlling in the company and the monitoring of deviations
H_1	There is a statistically significant relationship between the existence of controlling in the company and the monitoring of deviations
Significance of the test (p value)	0.0001
Comparison	$p < 0.05$
Result of the test	Acceptance of H_1
Pearson's correlation coefficient	0.4093

Source: own processing, XLStat

Table 2: The result of the Chi-square test and the Pearson correlation coefficient.

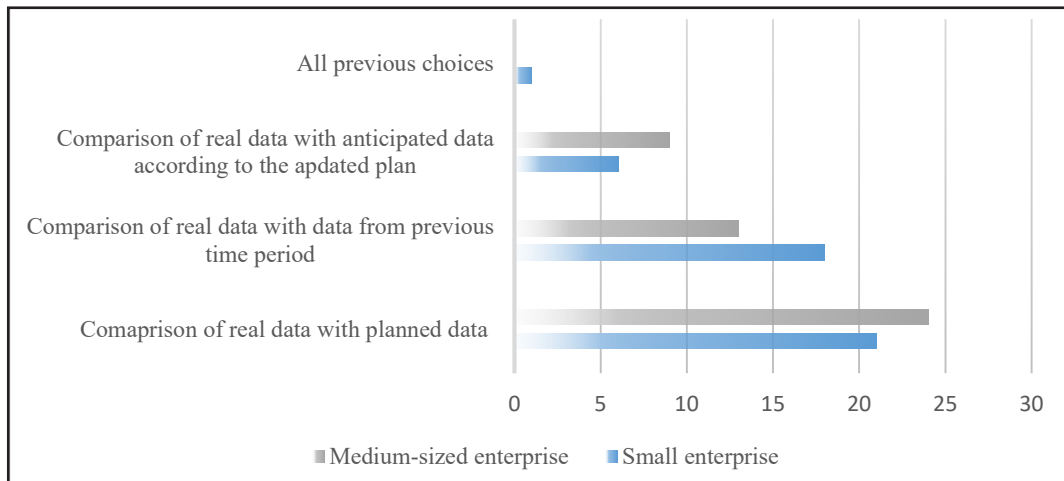

Source: own processing

Figure 3: Method of deviations monitoring within agricultural holdings.

of the small enterprises, a total of 21 (46%) and the most medium-sized enterprises, a total of 24 (52%) compare the actual data with the planned data. The comparison of the actual data with the expected data according to the updated plan is performed by 6 (13%) small agricultural entities and 9 (20%) medium-sized ones. Only 1 small enterprise (2%) stated that it implements all previous methods of monitoring deviations.

The fact that farms are not flexible by planning we evaluate as a negative fact. Látečková et al. (2018) also confirms that flexibility and integration are the basic factors of well-functioning economic systems. As explained in the abovementioned text, we must emphasize that only a small number of agricultural holdings incorporate into their original plans the changes that will occur during its implementation. It can be said that these farms approach planning is very flexible, using up-to-date information That is also reflected in their flexible management. Such planning and the resulting monitoring of deviations is desirable from the point of view of controlling. We further asked respondents who monitor the deviations if they are also looking for the cause of occurrence. The only identification of the generated deviations does not bring any useful information for the company. From all 92 agricultural holdings (small and medium-sized) following deviations, 91 (99%) of them looks also for the cause of deviation. Scholleová (2009), Petřík (2005), Fibírová and Šoljaková (2012) argue that even the most precisely defined and quantified deviation must always be supplemented by the cause of its occurrence. As the majority answered positively, we also examined the most common causes of deviations in their business. Respondents could choose more

than one option, or they could write their own answer.

From the Figure 4 it is clear at first sight that both small and medium-sized enterprises pay the greatest importance to the emergence of deviations related to changes in market conditions. 40 (87%) medium-sized enterprises and 39 (85%) small enterprises chose this option. The second most frequent response for all three types of companies was the change in weather conditions. This is due to the fact that, compared to other sectors of the economy, agriculture is significantly affected by the weather. This factor is not in the hands of agricultural holdings. Natural disasters, pests, diseases, animal diseases, epidemics are considered to be the most significant risks in agriculture. Changes in weather conditions, as the cause of deviations, concern 28 (61%) medium-sized enterprises and 34 (74%) small enterprises. Jankelová et al. (2017) confirm that the production process in agriculture directly depends on the climatic conditions, which determine the risk level in different ways in the individual areas. Changes in market conditions and changes in weather conditions are factors that are not entirely or at all controllable by agricultural holdings. According to Juričková et al. (2018) agricultural businessmen, therefore prefer to plan their managerial works in a shorter perspective, as they have to react to the challenges of given concrete and insisting situation.

The interview we conducted with selected agricultural subjects confirmed that the most common causes of deviations are the two factors described above. Farms also added that changes in weather conditions also affect changes

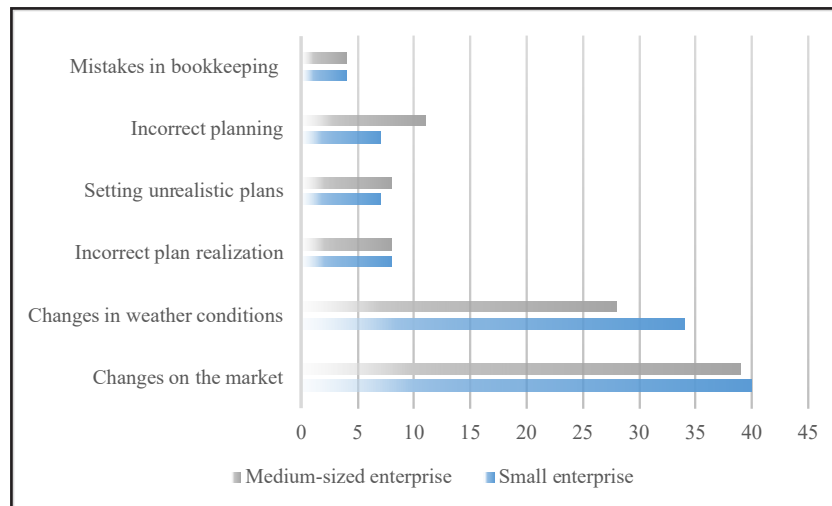

Source: own processing

Figure 4: Most common causes of deviations within agricultural enterprises.

in market conditions (e.g. due to the non-harvest of individual commodities, market prices increase and vice versa). There are also factors that are fully in the hands of the entrepreneurs. Farmers are aware that deviations can also be caused by deviations arising within the holding. These mainly cause such as incorrect planning, incorrect implementation of plans, setting unrealistic goals or errors in accounting.

Another question we asked was intended to find out in which activities and in which periods farms evaluate deviations. We offered respondents a choice of several options, or they could write their own answer. Using the Friedman test, we determined whether there were statistically significant differences in farm responses (Table 3).

H₀	There are no statistically significant differences in the frequency of evaluation of deviations for individual activities
H₁	There are statistically significant differences in the frequency of evaluation of deviations for individual activities
Significance of the test (p value)	0.0001
Comparison	$p < 0.05$
Result of the test	Acceptance of H ₁
Pearson's correlation coefficient	0.4093

Source: own processing, XLStat

Table 3: Results of Friedman test.

Using the Friedman test, we concluded that we reject the null hypothesis and accept

the alternative hypothesis, which states that there are statistically significant differences in the frequency of evaluation of deviations according to individual activities. A deeper look at the given issue is offered by Neményi's method. Results are given in the Table 4. According to the result of Neményi's method, we state that respondents most often check the price differences of inputs. The second most frequently performed control focused on the detection of deviations is the inspection of numerous states of outputs. On the contrary, the least attention is paid by agricultural holdings to the control of stocks, as well as to the control of product quality, because they do not carry out inspections in these activities as often as in the above-mentioned activities.

Activity	Groups
Inventory check	A
Quality control of outputs	A
Checking the numerous states of the outputs	A B
Control of price differences of inputs	B

Source: own processing, XLStat

Table 4: Results of Neményi's method.

The Figure 5 offers a more detailed look at how often agricultural entities evaluate deviations in specific activities. Most farms in the research sample inspect all the named activities at monthly intervals. A relatively large percentage of subjects evaluate deviations in the given activities on a weekly and quarterly basis. 20% of respondents stated that they evaluate deviations in the quality of outputs on a daily basis, and 15% of entities perform a daily inventory check. Some

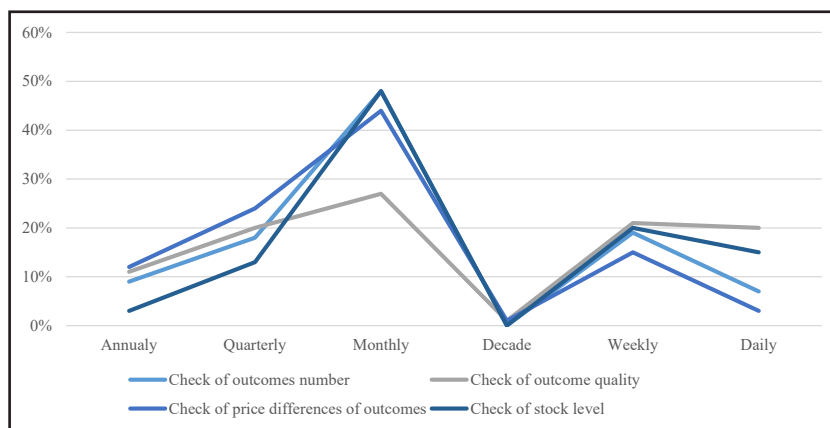

Source: own processing

Figure 5: Intervals for evaluating deviations in specific activities.

entities stated that they carry out inspections of the activities only annually. After an interview with selected agricultural entities, we can say that the daily control of the quality of outputs is carried out only in selected sections of production, especially in animal production. A typical example is a milk, the quality of which is checked every day. Also, the daily stock control is performed only in selected sections, e.g., compound feed for livestock and farm animals is inspected daily.

Conclusion

Companies in the Czech and Slovak Republic have been gradually adopting several concepts and tools for measuring and managing performance and are more familiar with them and the application process. The vast majority of their application is still limited in comparison to the rest of the world (Zámečník and Rajnoha, 2015). The issues of assessing the effectiveness of the company management system as a whole or of its individual sub-systems while making managerial decisions on their implementation are becoming an urgent issue of modern management (Kuzmina-Merlino and Savina, 2015). Monitoring and analysis of actual economic processes is an important tool for operational controlling. The aim of monitoring is to provide the management relevant information about the deviations of the actual revenues, expenses, profit, etc. (Dolinayová and Loch, 2015). Our research confirmed that the analysis of deviations is one of the most important controlling activities as there is a demonstrable statistical dependence between them (monitoring of deviations and the existence of controlling in the company). Deviation reflections focus on critically evaluating the success of decisions (Pietsch and Scherm,

2001). The problem of Slovak agricultural enterprises is that they compare the resulting deviations by comparing the actually achieved results with planned and not with expected results according to the updated plan. From the creation of the plan to its comparison with reality, they do not incorporate any changes occurring during its implementation. Such an approach lacks the basic feature of controlling, namely the reaction over time. The most common cause of deviations are changes in market conditions, which often result from changes in weather conditions, on which agriculture is more dependent than other sectors. Analysis of deviations should be a priority for all companies that want to be competitive in the market. However, our research has revealed shortcomings in this area. Not just the analysis of deviations, but also the planning itself represents important controlling activity. These two activities can bring effective results only if they are interconnected. Our research revealed that shortcomings made by farms are caused by insufficient planning. Respondents' answers pointed to the low flexibility of farms in response to changes in planning. Based on our finding we suggest further research is needed. If company lack a good and precise planning system, it is almost unimaginable to analyse deviations and their causes. If a business entity is interested in completing their business as long as possible, it is necessary to realize innovations that drive business and are regarded as a tool to maintain competitiveness (Rajnoha and Lorincová, 2015).

The future of agricultural enterprises depends on the flexibility of the management concept, which can respond quickly to frequent, dynamically changing market conditions. Deviations analysis as one of the tasks of controlling leads to corporate

flexibility. It reveals differences before the end of the process and allows corrective action to be taken at an early stage to prevent inconsistency between the reality and the plan.

Acknowledgements

This paper was supported by the Grant Agency of the Slovak University of Agriculture in Nitra under project GA 30/2019.

Corresponding authors

Ludmila Dobošová

Faculty of Economics and Management, Slovak University of Agriculture in Nitra

Tr. A. Hlinku 2, 949 01 Nitra, Slovak Republic

Phone: +421908531150, E-mail: ludmila.dobosova@uniag.sk

References

- [1] Bednárová, L. (2008) "Projekt zavádzania finančného controllingu v malých a stredných podnikoch", *Projektový management - teorie a praxe*, Reviewed collection of papers, Zlín, Tomas Bata University. ISBN 978-80-7318-695-1. (in Slovak).
- [2] Dobrovič, J. (2015) "Regional Development of Small and Medium-Sized Enterprises (smes) in the Prešov Region with Focus on Tourism", *Procedia Economics and Finance*, Vol. 34, pp. 594-599. ISSN 2212-5671. DOI 10.1016/S2212-5671(15)01673-1.
- [3] Dolinayová, A. and Loch, M. (2015) "Controlling Instruments Used for Monitoring and Evaluation Processes in the Rail Freight Companies", *Procedia Economics and Finance*, Vol. 34, pp. 113-120. ISSN 2212-5671. DOI 10.1016/S2212-5671(15)01608-1.
- [4] Fibírová, J. and Školjaková, L. (2010) "Reporting", 3rd ed., Grada Publishing, Prague. 224 p. ISBN 978-80-247-2759-2.
- [5] Foltínová, A. and Dubcová, G. (2010) "Aplikácia vybraných modelov analýzy nákladov v operatívnom controllingu", In *Aktuálne pohľady na konkurencieschopnosť a podnikanie*. Bratislava, EKONÓM. pp. 39-49. ISBN 978-80-225-3079-8. (in Slovak).
- [6] Ganeva, G. (2020) "Deviation analysis as a control method", *Trakia Journal of Sciences*, Vol. 18, No. 1, pp. 625-629. E-ISSN 1313-3551, ISSN 1312-1723. DOI 10.15547/tjs.2020.s.01.100.
- [7] Hradecký, M., Lanča, J. and Šiška, L. (2008) "Manažerské účetnictví", 1th ed., Grada Publishing, Prague, 259 p. ISBN 8024724715. (in Czech).
- [8] Chrenková, I. (2011) "Controlling in the conditions of Czech Republic", *AGRIS on-line Papers in Economics and Informatics*, Vol. 3, No. 2, pp. 3-14. ISSN 1804-1930.
- [9] Jankelová, N., Masár, D. and Moricov, Š. (2017) "Risk factors in the agriculture sector", *Agricultural Economics*, Vol. 63, pp. 247-258. E-ISSN 1805-9295, ISSN 0139-570X. DOI 10.17221/212/2016-AGRICECON.
- [10] Juričková, Z., Kapsdorferová, Z. and Kadlečiková, M. (2018) "The state of management development in agricultural entities", In *Internation scientific days 2018*, Prague: Wolters Kluwer ČR., pp. 1708-1721. ISBN 978-80_7598-180-6.
- [11] Kuzmina-Merlino, I. and Savina, S. (2015) "Assessing the Effectiveness of Improved Financial Management System Using the Expertise-oriented Approach", *Procedia-Social and Behavioral Sciences*, Vol. 207, No. 20, pp. 833-842. ISSN 1877-0428. DOI 10.1016/j.sbspro.2015.10.174.
- [12] Laval, V. (2015) "Impact of recent megatrends on the controlling role model", *Procedia Economics and Finance*, Vol. 27, pp. 54-63. ISSN 2212-5671. DOI 10.1016/S2212-5671(15)00971-5.
- [13] Látečková, A., Bolek, V. and Szabo, L. (2018) "Information Systems in Agricultural Enterprises: An Empirical Study in Slovak Republic", *AGRIS on-line Papers in Economics and Informatics*, Vol. 10, No. 2, pp. 49-60. ISSN 1804-1930. DOI 10.7160/aol.2018.100205.
- [14] Lojda J. (2011) "Manažerské dovednosti", 1th ed. Grada Publishing, Prague. ISBN 978-80-247-3902-1. (in Czech).

- [15] Máče, M. (2013) "Účetnictví a finanční řízení", 1th ed., Grada Publishing, Prague. ISBN 9788024745749. (in Czech).
- [16] Mura, L. and Buleca, J. (2014) "Trends in international business of the Slovak small and medium food enterprises", *Procedia-Social and Behavioral Sciences*, Vol. 110, pp. 905-912. ISSN 1877-0428. DOI 10.1016/j.sbspro.2013.12.936.
- [17] Petřík T. (2005) "Ekonomické a finanční řízení firmy. Manžerské účetnictví v praxi", 1th ed., Grada Publishing, Prague. ISBN 9788024710464. (in Czech).
- [18] Pietsch, G. and Scherm, E. (2001) "Die Reflexionsaufgabe im Zentrum des Controlling", *Controlling & Management Review: Zeitschrift für Controlling und Management*, Vol. 45, No. 5, pp. 307-313. ISSN 2195-8270. DOI 10.1007/BF03254043. (in German).
- [19] Pletnev, D. and Barkhatov, V. (2016) "Business success of small and medium sized enterprises in Russia and social responsibility of managers", *Procedia-Social and Behavioral Sciences*, Vol. 221, pp. 185-193. ISSN 1877-0428. DOI 10.1016/j.sbspro.2016.05.105.
- [20] Popesko, B. and Papadaki, Š. (2016) "Moderní metody řízení nákladů", 2th ed., Grada Publishing, Prague. ISBN 978-80-247-5773-5. (in Czech).
- [21] Rajnoha R. and Lorincová S. (2015) "Strategic Management of Business Performance Based on Innovations and Information Support in Specific Conditions of Slovakia", *Journal of Competitiveness*, Vol. 7, No. 1, pp. 3-21. E-ISSN 1804-1728, ISSN 1804-171X. DOI 10.7441/joc.2015.01.01.
- [22] Rautenstrauch, T. and Müller, Ch. (2005) "Verständnis und Organisation des Controlling in kleinen und mittleren Unternehmen", *Zeitschrift für Planung & Unternehmenssteuerung*, Vol. 16, pp. 189-209. ISSN 1613-9267. DOI 10.1007/BF02848578. (In German).
- [23] Sedliačiková, M., Šatanová, A. and Foltínová, A. (2012) "Finančný controlling v teórii a praxi malých a stredných podnikov", *Ekonomický časopis*, Vol. 60, No. 9, pp. 949-965. ISSN 0013-3035. (In Slovak).
- [24] Sedliačiková, M., Vacek, V. and Sopková, E. (2015) "How Slovak small and medium enterprises perceive financial controlling", *Procedia Economics and Finance*, Vol. 26, pp. 82-85. ISSN 2212-5671. DOI 10.1016/S2212-5671(15)00842-4.
- [25] Serina, P. (2012) "Controllingový prístup manažmentu nákladov vo verejnej správe", In: *Aktuálne problémy podnikovej sféry*, Collection of scientific papers, Bratislava, EKONÓM. pp. 469-474. ISBN 978-80-225-3427-7. (in Slovak).
- [26] Scholleová, H. (2009) "Investiční controlling", 1th ed., Grada Publishing, Prague. ISBN 978-80-247-2952-7. (in Czech).
- [27] Simić, S. and Mašić, B. (2013) "Controlling function is necessary in modern organizations busines", *Metalurgia International*, Vol. 18, No. 6, pp. 226-230. ISSN 1582-2214.
- [28] Smejkal, V. and Rais, K. (2013) "Řízení rizik ve firmách a jiných organizacích", 4th ed., Grada Publishing, Prague. ISBN 978-80-247-4644-9. (in Czech).
- [29] Sósová, V. (2013) "Zavádzanie personálneho controllingu v MSP", In *Aktuálne problémy podnikovej sféry*, Collection of scientific papers, Bratislava, EKONÓM. pp. 498-503. ISBN 978-80-225-3636-3. (in Slovak).
- [30] Stanciu, R. D. (2014) "Do Romanian small and medium-sized enterprises use performance management? An empirical study", *Procedia Social and Behavioral Sciences*, Vol. 124, pp. 255-262. ISSN 1877-0428. DOI 10.1016/j.sbspro.2014.02.484.
- [31] Steklá, J., Gryčová, M. and Homolka, J. (2015) "Evaluation of capital structure of agricultural cooperatives", *AGRIS on-line Papers in Economics and Informatics*, Vol.7, No. 3, pp. 37-48. ISSN 1804-1930. DOI 10.7160/aol.2015.070304.

- [32] Swinnen, J., Depaire, B., Jans, M. J. and Vanhoof K. (2012) "A Process Deviation Analysis – A Case Study", In Daniel F., Barkaoui K., Dustdar S. (eds) *International Conference on Business Process Management, BPM 2011, Lecture Notes in Business Information Processing*, Col. 99, Springer, Berlin, Heidelberg. DOI 10.1007/978-3-642-28108-2_8.
- [33] Šebej V. and Foltínová E. (2011) "Nachádza finančný controlling uplatnenie aj v malých a stredných podnikoch?", *Aktuálne pohľady na konkurencieschopnosť a podnikanie. Nové výzvy*, Collection of scientific papers, Bratislava, EKONÓM. pp. 503-507. ISBN 978-80-225-3200-6. (in Slovak).
- [34] Váryová, I., Košovská, I. and Vaňová, A. F. (2012) "Information tools of cost managing in agricultural enterprises", *Ekonomika Pol'nohospodárstva*, Vol. 12, No. 3, pp. 58-66. ISSN 1335-6186. DOI 10.22004/ag.econ.231861.
- [35] Yoshino, N. and Taghizadeh-Hesary, F. (2019) "Optimal credit guarantee ratio for small and medium-sized enterprises' financing: Evidence from Asia", *Economic Analysis and Policy*, Vol. 62, pp. 342-356. ISSN 0313-5926. DOI 10.1016/j.eap.2018.09.011.
- [36] Zámečník, R. and Rajnoha, R. (2015) "Business process performance measurement under conditions of business practice", *Procedia Economics and Finance*, Vol. 26, pp. 742-749. ISSN 2212-5671. DOI 10.1016/S2212-5671(15)00833-3.

Digitalization of Agricultural Industry – the Vector of Strategic Development of Agro-industrial Regions in Russia

Olga Anatolyevna Chernova¹, Inna Vasilievna Mitrofanova², Izabela Adamickova³, Elena Valerjevna Kleitman⁴

¹ Southern Federal University, Rostov-on-Don, Russia

² Federal Research Centre the Southern Scientific Centre of the Russian Academy of Sciences (SSC RAS), Rostov-on-Don, Russia

³ Slovak University of Agriculture in Nitra, Slovak Republic

⁴ Volgograd Institute of Management, Russian Presidential Academy of National Economy and Public Administration, Volgograd, Russia

Abstract

Today the strategic vector of agricultural development is connected with the introduction of digital technologies. Digitalization leads not only to transformation of production processes in the industry but as well has much wider environmental, social and institutional context. This paper is aimed at finding out what digital transformations have the most strategic significance for social and economic development of agro-industrial regions of the south of Russia, as well as at revealing the factors fostering or constraining these processes. Digital transformation in the south Russian regions has just affected the first level – application of new information technologies for raising economic performance and simultaneous alleviating environmental problems. The perspectives of digitalization of the agriculture are connected with developing open collaborative systems with different types of business collaborations. The authors highlight the main problems of realizing digital transformations in the agriculture of the south regions solving of which can be provided by means of authorities' institutional decisions within regional strategies of digitalization. This research gives an idea of the potential of agricultural digitalization and its results can be used for forming theoretical and methodological grounds for strategic development of agriculture in agro-industrial regions in modern circumstances.

Keywords

Digitalization, economic performance, agro-ecological systems, agro-industrial regions, regional development.

Chernova, O. A., Mitrofanova, I. V., Adamičková, I. and Kleitman, E. V. (2022) "Digitalization of Agricultural Industry – the Vector of Strategic Development of Agro-industrial Regions in Russia", *AGRIS on-line Papers in Economics and Informatics*, Vol. 14, No. 1, pp. 45-58. ISSN 1804-1930. DOI 10.7160/aol.2022.140104.

Introduction

Digitalization is an important factor of modernizing agricultural production and providing its competitiveness in the world market. Nowadays the main prerequisites for developing digital processes in agriculture such as complicating logistics systems, the necessity of renewing out-of-date material and technical base, general greening of production processes have been formed. The pandemic COVID-19 that required to transfer some business processes to online mode even strengthened this trend and led to the actual absence of any alternative

to the process of transferring to digital technologies even in the most inert agricultural industries with the lowest demand for advanced technologies among the sectors of economy.

The process of AIC digitalization (AIC digitalization) is especially actual for agro-industrial regions of the South of Russia. Digital transformations will foster the increase in labour productivity, cropping capacity and etc. Digital technologies are the key determinant of the transferring to the new technological mode in AIC (Maksimova and Zhdanova, 2018). As it was highlighted in the research of the

cooperation project «German and Russian agro-political dialogue», the potential of digitalization implies reducing conflicts of aims at using lands as the production factor¹.

It is important not only to implement «smart» technics, but as well to maximally realize digitalization opportunities in agriculture for using economic and social potential of the region to the most extent. Digitalization of the agriculture leads not only to transformation of the production processes in AIC but as well has much wider environmental, social and institutional context. This paper is aimed at finding out what digital transformations have the most strategic significance for social and economic development of agro-industrial regions of the south of Russia, as well as at revealing the factors fostering or constraining these processes. The hypothesis of this research implies that digital transformations in agriculture not only favour innovative development of the industry but as well have strategic meaning for social and economic development of the region.

So far the term “digitalization” has had “vague” meaning. Some authors both in academic and business environments trying to learn the essence of the notion “digitalization” embrace a large variety of different phenomena and processes.

In international handbooks on statistical measuring of the level of digitalization of industries, this notion is understood as the process of introducing digital resources for solving different problems. In the world review of realization of the conception “Industry 4.0” for 2016 digitalization is defined as vertical integration of business models in one organization implying introduction of digital technologies at all stages: development, procurement, production, logistics and service². The term “digitalization” is defined by many researchers in their papers within the conception “Industry 4.0” For instance, C. Hopmann and M. Schmitz describe digitalization as successive application of “digital” methods and instruments during the whole process of development and production of the product including planning and quality management (Hopmann and Schmitz, 2020). T. Jeske, M. Würfels and F. Lennings represent digitalization as the process

of introducing artificial intelligence, methods of data and information management as well as improving personnel qualification due to advances in production technologies (Jeske, Würfels and Lennings, 2021).

Process approach to the research of digital transformations in the economy is reflected in papers of the Russian scientists. Thus, for instance, T. Judina defines digitalization as the process of transferring from robotic automation to the new production based on introduction of digital technologies leading to digital capital expansion (Judina, 2018). V. Tsirenschikov also defines digitalization as on-going process of implementing digital technologies in different spheres of activity (Tsirenschikov, 2019).

The researchers of the digitalization processes within the conception “Industry 4.0” assign a leading role in their development to technologies of high-speed data transmission, Internet-technologies highlighting technological aspects of this process. For instance, L. Geris, T. Lambrechts et al. define digitalization as a combination of processes of automatization, informatization, exchange of technologies using “digital twins” – digital presentation of a product or a process which is used for projecting optimization (Geris, Lambrechts, Carlier and Papantoniou, 2018).

However, over the last years an increasing number of scientists pay attention not only to technological but to social and economic aspects of digitalization, for instance, T. Pschybilla, A. Homann highlight that digitalization implies not only technological development of a company but its overall transformation including changes in hierarchical structures and personnel’s behavior as well as presenting and exchange of information (Pschybilla and Homann, 2020).

T. Mirolyubova et al. determining indices of digital economy include in it the whole complex of relations formed at using digital technologies in the system of production, distribution, exchange and consumption of tangible and intangible goods (Mirolyubova, Karlina and Nikolaev, 2020). This approach enables to pay attention to the necessity of interconnected functioning of technological, economic and social subsystems where managing information is the key determinant creating value of the whole system.

In researches of digitalization processes in agriculture ecosystem approach prevails.

¹ Digitalization of agricultural production in Russia from 2018 to 2025. https://agrardialog.ru/files/prints/apd_studie_2018_russisch_fertig_formatiert.pdf

² PwC Global Digital IQ. https://www.pwc.ru/ru/technology/assets/global_industry-2016_rus.pdf.

For instance, Z. Kapelyuk, A. Aletdinova pay attention to the fact that in order to provide sustainable development of agricultural enterprises it is necessary to maintain bio-productivity of ecosystems; and existing intensive technologies are not enough; it is necessary to provide active use of digital solutions (Kapelyuk and Aletdinova, 2017). O. Kolomyts and I. Ivanova consider creating digital agro-food ecosystems as the vector of strategic development of agricultural areas (Kolomyts and Ivanova, 2020). Ashlee-Ann E. Pigford et al. have similar views and to their perspective digital agro-innovative ecosystems will foster transferring to sustainable development (Pigford, Hickey and Klerkx, 2018).

The role of digital technologies in developing ecosystem services in food chains are subject to investigation by A. Lajoie-O'Malley, K. Bronson et al., J. A. Wilhelm, R. G. Smith et al., who pay particular attention to the necessity of taking into consideration environmental consequences of digitalization projects realization. In particular studying insiders' perception of ecosystem consequences can become a determining factor in creating the strategy of land utilization and developing policy of agricultural production expansion (Lajoie-O'Malley, Bronson, Van der Burg and Klerkx, 2020; Wilhelm, Smith, Jolejole-Foreman and Hurley, 2020). N. Roux, T. Kastner et al. also put emphasis upon the impact of agriculture on the state of land ecosystems (Roux, Kastner, Erb and Haberl, 2021).

P. Phillips, G. Jobe et al. consider that introduction of new hardware facilities, applications for big data processing, software and other digital technologies by the farmers leads to the transformation of structures not only common for agricultural production but in related sectors as well (Phillips, Relf-Eckstein, Jobe and Wixted, 2019). In this sense the perspectives of digitalization of agriculture can be considered by means of ecosystem approach. Thus, D. C. Rose, J. Chilvers offer to approach digitalization from wider mapping of ecosystem aimed at revealing the spheres of potential cooperation generating new valuable opportunities (Rose and Chilvers, 2018). Investment in science-based-innovative technologies is a must to bring about improved livelihoods of farmers and their families by producing more and higher quality crops for national population; enhanced nutritional value and safety of food to improve the health and well-being of people; and agricultural sustainability through efficient resource use (Alaverdyan et al., 2015).

Agro-ecosystems have significant impact on social and economic development of the region, however there are different points of view concerning the character of their influence. The role of agriculture is obviously reflected not only in its contribution to the GDP but in the complex relationships how it influences the life of rural areas (Nagy-Káposzta, 2016). Some researchers consider that anticipated effects of digitalization of agriculture can include: creating additional jobs, increasing labour productivity, generating knowledge-based economy (Matthess and Kunkel, 2020). However, there is an opposing opinion according to which digital technologies are considered as a destructive factor for social and economic potential of a region, as a source of new problems related to labour, finances and etc. rather than a problem solving facility (Abbasabadi and Soleimani, 2021; Bundy, 2017). For instance, members of Via Campesina consider that introduction of digital technologies will lead to release of labour executing non-qualified work in agricultural sector. It can affect the level of unemployment in agro-industrial regions where agriculture has always provided most employment opportunities absorbing more employees³.

Researching the factors determining directions of digital transformations in agriculture K. Rijswijk, L. Klerkx, J. A. Turner highlight that the level of digitalization of agricultural enterprises in the regions is mostly determined by the agricultural producers' understanding of their own place in regional production systems. According to the researches of these authors most of agricultural producers interpret digitalization as a process oriented at developing enterprise's internal environment rather than strategic changes of the role of agriculture in regional economic system. We consider that this interpretation of digital processes leads to digital transformations of targeted character that makes it impossible to create single regional digital landscape (Rijswijk, Klerkx and Turner, 2019).

This review enables to highlight a number of different factors determining effectiveness of realizing digital transformations in agriculture as well as to understand their role in social and economic development of a region. The authors of the paper suggest to understand digitalization of agricultural production as the process of making strategic decisions aimed at decreasing the extent of dependence of the production outcomes

³ La via Campesina policy documents 5th Conference. Mozambique, 16th to 23rd October 2008. <https://viacampesina.org/en/wp-content/uploads/sites/2/2010/03/BOOKLET-EN-FINAL-min.pdf>.

on environmental and climatic as well as anthropogenic factors by means of optimal production models generated by artificial intelligence on the basis of the data obtained by it as a result of fulfilling tactical tasks of production management (Mitrofanova, Chernova, Buyanova, Ivanov et al., 2019; Shelkovnikov, Petukhova and Alekseev, 2020).

Materials and methods

The research of the impact of digital transformations in agriculture on regional development should be started with considering what particular economic problems are taken into account at developing such projects. It will enable not only to estimate digitalization effects for agricultural enterprises themselves but to determine their contribution in fulfilling strategic challenges of social and economic development of the region. The main research issues were formulated as follows: what digital technologies are used in agriculture and what challenges are fulfilled with their help in the south regions of Russia; what perspectives and opportunities can be obtained by means of using digital technologies in agriculture for fulfilling strategic tasks of regional development?

Hence this research consists of the following major stages. The first stage implies determining main directions of developing digital technologies in agriculture. On the basis of literature review devoted to the subject under consideration digital technologies in agriculture are examined from the perspective of solving problems of economic development. The second stage implies consideration of the scenario of digital transformation of agriculture in agro-industrial regions of the south of Russia. Our review supposes revealing peculiarities of digitalization processes in these regions, considering the impact of the outcomes of these processes on social and economic potential of the area. The third stage implies drawing conclusions if taken measures aimed at digitalization of agriculture correspond to strategic goals of regional development. At these stage the factors and conditions for expansion of benefits from digitalization for the economy of the region are revealed.

The authors have applied a combination of methods including methods of descriptive statistics, review of the related researches reflecting application of digital technologies in agriculture. It is necessary

to note that this research is aimed at generalization of potential opportunities of using digital technologies for meeting strategic goals of social and economic development of agro-industrial regions rather than analyzing practical usage of particular digital technologies in agriculture.

The study subject is represented by the south regions of Russia: Krasnodar Region, Rostov and Volgograd Regions having agro-industrial specialization (AIC is in the 2nd place as a contributor to GRP). The choice of these regions is determined by their significant contribution to producing agricultural goods in Russia. In terms of the key agricultural indices Krasnodar region is in the 1st place, Rostov Region – in the 2nd place, Volgograd Region – in the 9th place. The information base of the research is represented by Rosstat (Russian Federal State Statistics Service) data, reports of the Ministry of Agriculture of the RF on realization of the program “Digital Agriculture” as well as official data allocated on the sites of regional and municipal authorities of the areas under examination as well as data of rating agencies.

Results and discussion

Digital transformation in agriculture: sources and directions of value creation

Intensive development of digital technologies in Russian agricultural production started since signing the Edict of the President of the Russian Federation No. 204 “On National Goals and Strategic Challenges of Development of the Russian Federation for the period up to 2024”⁴, which set the goal of transforming priority industries of the economy including agriculture by means of introducing digital technologies platform solutions. Within realization of this goal the industry-related project “Digital Agriculture” was developed with time frame 2019–2024⁵.

At the beginning of the project realization Russia took very low positions on the level of digitalization of agriculture – the last place among European countries, the Republic of Korea,

⁴ Edict of the President of the Russian Federation from 07.05.2018 No. 204 “On National Goals and Strategic Challenges of Development of the Russian Federation for the period up to 2024”. <http://publication.pravo.gov.ru/Document/View/0001201805070038>.

⁵ Industry-related project “Digital Agriculture”: official addition . Moscow, “Rosinformagrotech” Publ., 2019. 48 c. <https://mcx.gov.ru/upload/iblock/900/900863fae06c026826a9ee43e124d058.pdf>.

Turkey and Japan⁶. It's probably caused by the fact that during industrial development (till the end of 20th century) it was commonly accepted that strategically important directions of agro-industrial complex should be determined by internal goals and objectives of the industry rather than dictated by other industries and sectors of economy (Toguzayev, Toguzayev and Modebadze, 2020). Along with it the national agriculture has always been characterized by its low investment attractiveness due to long production cycle and high natural and climatic risks.

However, development of the “digital era” couldn't leave untouched many processes in the sphere of AIC. Understanding of the necessity of digitalization in agriculture is determined by its significant lack behind Western Europe, Canada, the USA, Australia, China on indices of labour productivity, cropping yield, and others. Digitalization is supposed to enable to make a significant technological breakthrough in the sphere of AIC. However nowadays development of the digitalization processes in Russian agriculture can be characterized as “tactics of quick victories” according to which some elements of digital economy are implemented only where they are mostly required and at that they have the shortest pay-back period: satellite positioning of farm machinery and equipment; quality monitoring of executed works; resources accounting and control; control over animals' state; crop harvesting automation and etc.

Digitalization of agriculture in regions of Russia tends to move towards provision of agricultural productions with navigation systems as well as automation of organizational and managerial processes and cross-industry interactions. In countries leading in the agricultural market digital technologies robotize production, expand the range of big data application. At that digitalization of agriculture changes the whole regional landscape creating new business, economic, institutional mechanisms of development.

The estimation of the possible impact of digitalization of agriculture and forming agro-ecosystems on strategic development of the economy of the region should start with considering

what objectives were supposed to be fulfilled by means of using digital technologies in agriculture (Table 1).

Objectives fulfilled	Digital technologies
Increasing productivity of agricultural production using less fertilizers and with less environmental pollution	Geo-information monitoring systems of soils state, ecological situation. Remotely piloted vehicles. Maintaining optimal conditions for life organisms habitat, growth of plants in automated mode.
Information asymmetry related to agricultural production: financial services, marketing, access to production markets and etc.	Market places for marketing and selling agricultural production to small enterprises. Instruments for raising digital literacy
Minimizing errors in complex production processes by means of interaction model “live organism – technical systems”	Using neuro-technologies and artificial intelligence for seeds choice and selection
Raising economic efficiency of agricultural production	Agricultural machinery sharing based on digital platforms. Using remotely piloted vehicles for seeds planting
Distant management. Raising control and management coverage of agricultural arrears	Geo-information systems of growth monitoring of crops by means of satellite systems, early disease detection of plants. Irrigation management
Managing finances and monitoring commercial transactions	Digital solutions in logistics. Sales monitoring systems. Smart-contracts.

Source: Own processing

Table 1: Objectives of agricultural production fulfilled by means of using digital technologies in Russia.

On the basis of the presented data it can be assumed that digitalization of agriculture in Russia applies innovations as the source of economic growth. It means that any technological perspective can be interpreted within the question of reasonability of using this or that advanced technology in agricultural system. The main desired result of expanding digitalization processes in agriculture is providing profitability and sustainability of production systems development (Gaál, Molnár, Illés, Kiss, Lámfalusi and Kemény, 2021), raising market value of the company which in many respects is determined by digital assets. It can be proved in particular by the indices estimating the level of digitalization of AIC in regions

⁶ Digital Transformation of Industries: Starting Conditions and Priorities: Reports to XXII April International Scientific Conference on Problems of Developing Economy and Society. Moscow, “Higher School of Economy” Publ., 2021. 239 p. https://www.researchgate.net/publication/351035378_Cifrova_transformacia_otraslej_startovye_uslovia_i_prioritety.

developed by the Ministry of agriculture of the RF: testing pilot solutions and their replication, full service application of digital government and new digital technologies, introduction of amendments to normative acts providing realization of the industry project “Digital agriculture”, unifying and application of centralized decisions as well as having an opportunity switching to the existing regional systems with high level of development of IT technologies in agriculture⁷. This orientation significantly distracts researchers from opportunities of fulfilling tasks of digital development of agriculture as an agro-ecosystem whereas processes of agriculture digitalization can significantly change public face of agro-industrial regions transforming not only their agricultural systems but as well the whole regional landscape. Besides digitalization can make agriculture attractive for the youth at the same time stimulating demographic renewing of agricultural arrears.

Agricultural biodiversity, landscapes, the range of services which can be provided by agro-ecosystem are in many ways connected with measures of regional management of agriculture digitalization processes (Shah, Liu, Yang, Wang, Casazza et al., 2019). That is why further we are going to consider how agriculture digitalization opportunities are realized in practice of regional strategic planning of the south agro-industrial regions of Russia.

⁷ Expanded Review of Development of Agricultural Digitalization in the RF. State and Perspectives. As of April-May 2020. https://agrardialog.ru/files/prints/rasshirenniy_obzor_razvitiya_tsifrovizatsii_selskogo_hozyaystva_v_rf_aprel_may_2020.pdf.

Trends of digital transformations in agriculture (by the example of agro-industrial regions of the south of Russia)

In order to highlight and think over the main trends of development of digital processes in agriculture of agro-industrial regions of the south of Russia, conceptualize links related to the consequences of digitalization firstly let us characterize the present state of this sector in the regions under examination.

Agriculture has a significant role for Krasnodar, Rostov and Volgograd Regions. The share of this sector of economy in GRP makes up slightly over 10 percent.

As it can be seen from the Figure 1 agriculture of Krasnodar Region is developing relatively stable whereas Rostov and Volgograd Regions are distinguished by unstable character of development of agricultural productions.

Growth indices of crop production in the areas are more changeable than growth indices of animal production (Figure 2, 3) that is caused by higher sensitivity of this sector to natural and climatic factors. Simultaneously we can note that in Rostov Region there is a trend to decreasing animal production.

Development of the agricultural production is connected with solving problems of import substitution (Mitrofanova, Buyanova, Chernova, Ivanov et al., 2019) and increasing export of agricultural production that is provided by means

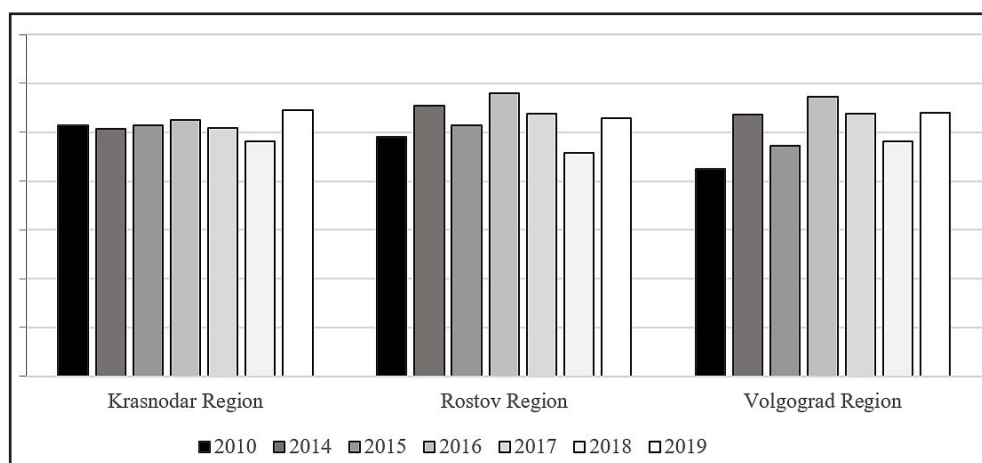

Source: Regions of Russia. Social and Economic Indices. 2020: Statistical Digest. Moscow, “Rosstat” Publ., 2020. 1242 p.

https://rosstat.gov.ru/storage/mediabank/LkooETqG/Region_Pokaz_2020.pdf.

Figure 1: Indices of agricultural production in agro-industrial regions of the South of Russia, as a percentage over the previous year.

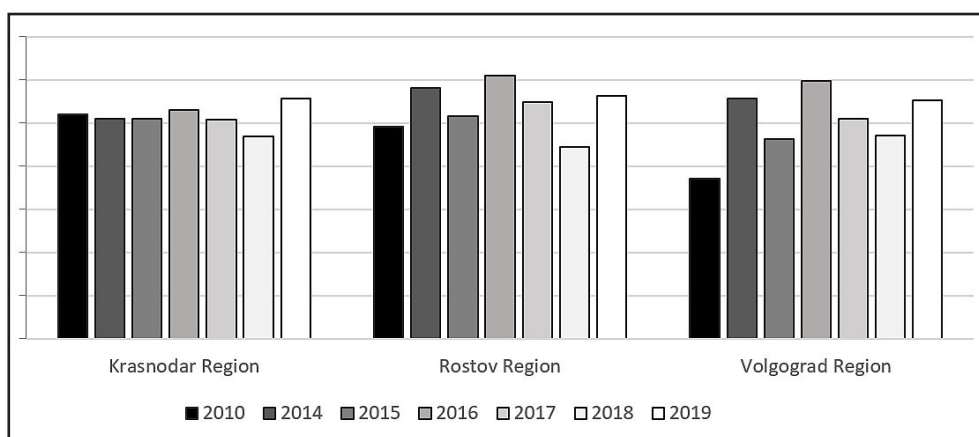

Source: Regions of Russia. Social and Economic Indices. 2020: Statistical Digest. Moscow, “Rosstat” Publ., 2020. 1242 p. https://rosstat.gov.ru/storage/mediabank/LkooETqG/Region_Pokaz_2020.pdf.

Figure 2: Crop production in agro-industrial regions of the South of Russia, as a percentage over the previous year.

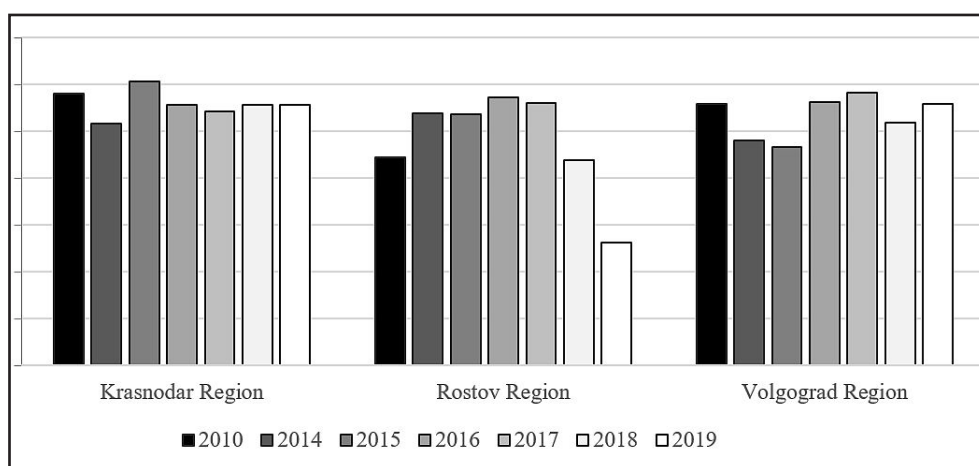

Source: Regions of Russia. Social and Economic Indices. 2020: Statistical Digest. Moscow, “Rosstat” Publ., 2020. 1242 p. https://rosstat.gov.ru/storage/mediabank/LkooETqG/Region_Pokaz_2020.pdf.

Figure 3: Animal production in agro-industrial regions of the South of Russia, as a percentage over the previous year.

of increasing areas under crops (Figure 4), as well as increasing crop productivity (Figure 5).

The structure of agriculture in the regions is represented by agricultural organizations of different sizes. Among the largest agro-industrial holding in the South of Russia there are the following: “Jug Rusi”, “Aston”, “Agrocomplex”, “Step”, “Kuban”, which accumulate over two thirds of revenues in Russian AIC. However the most agro-holdings’ revenue is generated trading oil products, gas and liquid fuels and etc⁸.

Peasant (farm) households cover 30-40%

⁸ Expert-Jug. News and Business Practice. <https://expertsouth.ru/main/top-5-krupneyshikh-agropromyshlennykh-kholdingov-yuga-rossii/>.

of agricultural production. Low-technology production prevails on most farms. Agricultural enterprises widely use non-qualified labour. The share of the employed in agricultural production makes up 11–13% (the second place after trade).

Profitability of sold goods and products of agricultural organizations is represented on Figure 6. Farmers, small and medium-size enterprises experience the most difficult financial state. It is mostly caused by the problems connected with selling their products: working with wholesalers is considered to be disadvantageous and designing trading places implies significant costs related to renting trading places, undergoing control and paying the salary to the seller.

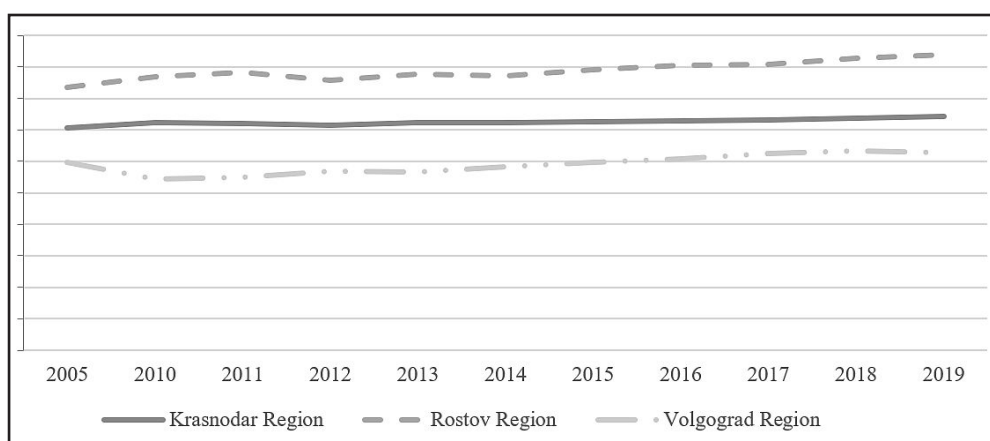

Source: Regions of Russia. Social and Economic Indices. 2020: Statistical Digest. Moscow, “Rosstat” Publ., 2020. 1242 p.

https://rosstat.gov.ru/storage/mediabank/LkooETqG/Region_Pokaz_2020.pdf.

Figure 4: Areas under crops in agro-industrial regions of the South of Russia, as a percentage over the previous year, tsd. hectare.

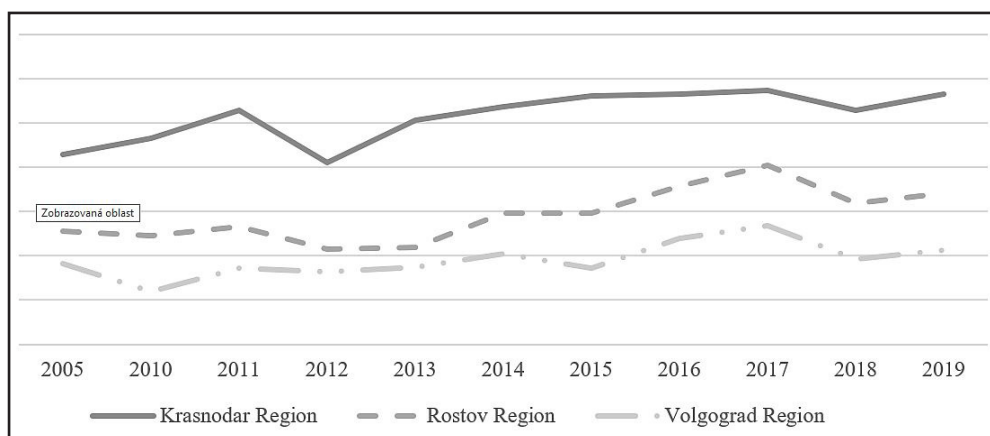

Source: Regions of Russia. Social and Economic Indices. 2020: Statistical Digest. Moscow, “Rosstat” Publ., 2020. 1242 p. https://rosstat.gov.ru/storage/mediabank/LkooETqG/Region_Pokaz_2020.pdf.

Figure 5: Productivity of grains and grain legumes in agro-industrial regions of the South of Russia, as a percentage over the previous year, centner per hectare.

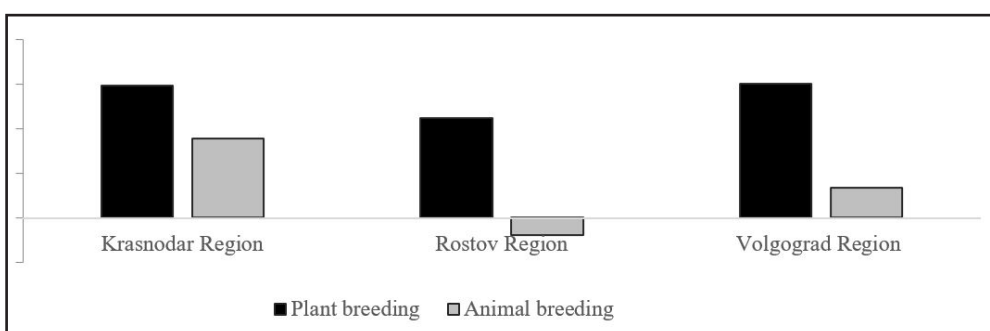

Source: Regions of Russia. Social and Economic Indices. 2020: Statistical Digest. Moscow, “Rosstat” Publ., 2020. 1242

Figure 6: Profitability of sold goods and products of agricultural organizations in agro-industrial regions of the South of Russia, %

The degree of depreciation of the main assets in agriculture makes up in Rostov Region 46,3% (including completely depreciated ones -13,4%), in Krasnodar Region 44% (including completely depreciated ones -12,4%), in Volgograd Region 34,1% (including completely depreciated ones -8,5%)⁹.

According to the expert reviews digital technologies have been introduced up to 5% of households. The most popular digital technology in agriculture is navigating agricultural machinery, inventory, monitoring executed works by means of cheap GPS-detectors that is why it was applied in many agricultural enterprises. Agro-holdings are considering the perspective of digitalization trying to assess economic effect of digitalization of all stages of agricultural production.

In plant breeding segment digitalization implies using satellite technologies for monitoring the state of cultivated lands, transport vehicles, parallel driving as well as differentiated spraying of weeds, crops, fertilizing and irrigating. At that these technologies cover up to 10% of lands under crops. Decisions of using precision agriculture are made in less than 3% of farms¹⁰. For comparison in countries of the European Union this index reaches 80%¹¹.

In animal farming the elements of precision breeding are used for monitoring the state of health of the flock and individual species as well as for monitoring the quality of animal production, and the digital data bases of production processes are formed.

Estimating the first results of digital transformations in agriculture of the regions of the South of Russia there can be highlighted two main models of development of these processes.

1. «Entrepreneurial startup» Integration of software and digital analytics into customer packet of services. Many entrepreneurs use those digital technologies that solve particular problems of their agricultural production This model is typical for small and medium-sized enterprises.

2. «Corporative model» Digital innovations are combined with modernization of material resources and technology. The example of such model is an integration of large agro-holding with world producers of agricultural machinery for mutual usage of digital opportunities.

Regardless of the model of digital processes development digital transformations in agriculture of the south Russian regions are initiated from the top downwards within realization of industry projects and taking measures as a response to authorities' requirements for environmental protection. Internal factors determined by anticipating financial benefit or caused by the trust to digital transformations as a source of economic development do not appear to be a significant driving force.

Responses to digitalization can be described as preliminary as it has not become a core component of organization development and value creating basis yet.

Both business and regional authorities interpret digital agriculture in the context of problems faced by domestic agriculture. That is why realized digitalization projects tend to have a targeted character and imply modernization changes for a particular enterprise aimed at raising its productivity.

The consequences of digitalization of a particular production are not considered in relation to other participants of the value creating chain neither agricultural producers nor regional authorities. As a result, we can observe different rates of changes in agricultural sector throwing no light on perspectives of industry development as a whole. Such approach creates a new challenge of managing mixed agricultural production at the regional level.

Only some large agro-holdings perceive digitalization strategically. The main implemented changes are connected with automation of managerial processes and interactions with state authorities. In other words most agricultural producers don't make any radical decisions related to digitalization, instead of it they continue to use traditional approaches and technologies.

Results and discussion

Ineffective development of agriculture endangers not only nature protection goals but as well existing chains of distributing agricultural production which

⁹ Regions of Russia. Social and Economic Indices. 2020: Statistical Digest. Moscow, "Rosstat" Publ., 2020. 1242 p. https://rosstat.gov.ru/storage/mediabank/LkooETqG/Region_Pokaz_2020.pdf.

¹⁰ Digital Transformation of Agriculture in Russia. Moscow, "Rosinformagrotech" Publ., 2019. 80 p. <https://mcx.gov.ru/upload/iblock/28f/28f56de9c3d40234dbdcbfac94787558.pdf>.

¹¹ Digitalization of Agriculture in Russia: stages, outcomes, plans. Geomet. <https://gpsgeometer.ru/blog/tsifrovizatsiya-selskogo-hozyajstva-v-rossii-etapy-itogi-plany>.

determine sustainability of social and economic development of the area. However, the main threat to agricultural development is local competition for land labor, and capital demonstrated by other more effective sectors rather than foreign agricultural producers (Phillips, Relf-Eckstein, Jobe and Wixted, 2019). Digital technologies enable agricultural enterprises to use new valuable opportunities.

However, in spite of multiple scientific proofs of social, economic and environmental benefits of digitalization introducing these processes in agricultural practice is still the central challenge of south Russian agro-industrial regions. Digitalization indices reflect social and economic practice of mixed economy established in the regions. At the present stage digital transformation of agriculture in the south Russian regions has affected the first layer – implementing new technologies for solving problems of economic productivity and simultaneous reduction of environmental problems.

The logical consequence of further introduction of digital technologies is forming open collaborative systems where all insiders will be able to choose business partners (Day and Sigrimis, 2020). In the world practice in particular the following forms of business interactions in the sphere of digitalization of agriculture has become commonly used: digital packet transactions related to the development of new forms of insurance for farmers from climatic risks; sharing land resources (agro-forest-melioration) for expanding forests on tillable lands aimed at preventing dust-storms sweeping out soil layer; creating digital ecosystem for all regional market insiders: transport and logistics companies, agricultural machinery, mechanization and fertilizers production related trade.

Expanding the sphere of applying digital technologies in the regions will foster forming agro-ecosystems as a complex of eco-system services taking into account production systems in which they are supposed to be integrated. The directions of agro-ecosystems development mostly depend on regional authorities understanding of their place in regional development. The standardized range of indices of ecosystem services providing includes: 1) biomass production; 2) refilling underground waters, 3) carbon storage; 4) generating the habitat for agricultural bio-diversity; 5) creating landscape attractiveness; 6) soil preservation (Ungaro, Schwartz and Piorr, 2021). Along with these direct ecosystem services some indirect ones can

be provided as well including regulating climate, agro-tourism, recreation, cultural and educational values (Shah, Liu, Yang, Wang et al., 2019).

Thus digitalization leads to the necessity of expanding cooperation: involving new partners, developing new forms of interaction, providing new kinds of services. However meeting these objectives is related to a number of problems:

- non-structured collaborative environment due to large share of shade sector of economy in AIC which is not ready to provide data revealing its performance;
- differences in perception of the value of economic effects of digitalization of agriculture by different economic agents;
- agricultural producers' orientation at production rather than sustainable development of regional ecosystem;
- the absence of motivation to realize digital projects on the part of agricultural producers;
- lack of funds experienced by small and medium-sized business and farmers necessary for realizing digitalization projects; for instance, a medium-sized farm needs 1 million rubles per year for introducing the technology of satellite monitoring;
- lack of agricultural personnel with digital competences;
- digital inequality between city and village related to the Internet access and level of digital literacy of population.

The opportunity of solving these problems is mostly determined by institutional decisions of regional authorities. For instance, developing of sharing economy can become an institutional decision fostering digitalization of small farms. In particular sharing agricultural machinery is actively experienced in Germany among small groups of farmers having close social relations. According to Nigeria and India's practice subcontractors possessing agricultural machinery and providing it to several farmers can gain more benefits using GPS-devices and software (Daum, Mayienga, Villalba, Kayode et al., 2020).

Thus, effective development of digitalization processes in agriculture of the South of Russia requires regional strategy of digitalization with assessment of obtained benefits and possible problems.

Analyzing activity of regional authorities in the sphere of digitalization it can be observed that its main directions are connected with realization of the industry project “Digital Agriculture” which at the first stage implies digital land inventory and introducing e-document flow (Mitrofanova, Chernova, Buyanova, Ivanov et al., 2019; Mitrofanova, Chernova and Patrakeeva, 2020). Realization of this program is supposed to enable application of the system of digital automation in agricultural production represented by “Smart Farm”, “Smart Field”, “Smart Greenhouse” and etc.

To our perspective regional strategies of agriculture digitalization must not only focus on technological aspects of industry program realization but as well give answers to the following questions principally important for social and economic development of the region:

- how to use digitalization processes for creating new jobs in rural areas including high-qualified ones;
- what institutional and technological decisions are required for providing participation of small and medium-sized agricultural producers and farmers in the processes of digitalization;
- what potential does digitalization have for raising ecological, tourist and recreational potential of the region;
- how can be assessed the consequences of digitalization for population, how can it influence standard and quality of life, incomes;
- how can the potential of financing of digitalization processes be assessed for different groups of agricultural producers.

Concurrently the system of regional control over the processes of digitalization in agriculture should provide integration of efforts of a large number of different actors: agricultural producers, suppliers of agricultural machinery, knowledge, environmental innovations. Coordination of digital models of developing of agricultural enterprises at the regional level would enable the following: 1) to prevent inequality in agricultural sector

Corresponding authors

Doc. Ing. Adamičková Izabela, Ph.D.

Slovak University of Agriculture in Nitra, Tr. Andreja Hlinku 2, Nitra, Slovakia

Phone: +421037641457, E-mail: izabela.adamickova@uniag.sk

ORCID: 0000-0003-4132-2543

by means of involving all insiders; 2) to provide compromise between agricultural products and services: for instance, animal breeding (pastures) – soil preservation; plant breeding – carbon storage (Zhong, Wang, Zhang and Ying, 2020; Vishnevskiy, Gokhberg, Dementjev, Dranev et al., 2021).

Conclusion

Social and economic consequences of digitalization in agriculture for regional development have been rarely discussed although such analysis can give information important to regional policy. In the whole this research gives idea of the digitalization potential in agriculture. As the result of the research the authors’ hypothesis that digital transformations of agriculture not only help to fulfill goals of innovative development of the industry but as well have strategic significance for social and economic development of the region has been proved. Digitalization is anticipated to lead to the productivity growth, increasing cropping yield, producing green goods, decreasing negative environmental effect. Many researchers highlight its impact on employment. However these issues require further examination since the absence of objectiveness can negatively influence regional policy.

It is necessary to note that abilities of getting benefit can differ depending on the level of development of agricultural production in the regions, for instance among developed and developing agricultural productions. That is why further researches will help to verify empirically conclusions made by authors.

Acknowledgments

The publication was prepared as part of the implementation of the State Assignment of the Southern Scientific Centre of the Russian Academy of Sciences (2022), project “Strategic vectors of development of the socio-economic complex of the south of Russia taking into account regional resilience (economic and demographic aspects)”, state registration No. 122020100349-6.

References

- [1] Abbasabadi, H. and Soleimani, M. (2021) "Examining the effects of digital technology expansion on Unemployment: A cross-sectional investigation", *Technology in Society*, Vol. 64. ISSN 0160-791X. DOI 10.1016/j.techsoc.2020.101495.
- [2] Alaverdyan D., Nagy, H., Panosyan, I. and Olagunju, K. (2015) "The impact of Technology Evaluation Program on agricultural productivity in Armenia", *Visegrad Journal on Bioeconomy and Sustainable Development*, Vol. 4, No. 2, pp. 62-69. E-ISSN 1339-3367. DOI 10.1515/vjbsd-2015-0014.
- [3] Bundy, A. (2017) "Smart machines are not a threat to humanity", *Communications of the ACM*, Vol. 60, No. 2, pp. 40-42. E-ISSN 1557-7317. DOI 10.1145/2950042.
- [4] Daum, T., Mayienga, S., Villalba, R., Kayode A., Gupta, S. and Birner, R. (2020) "Uber for Tractors? Opportunities and Challenges of Digital Tools for Tractor Hire in India and Nigeria", *SSRN Electronic Journal*, Feb., 34 p. E-ISSN 1556-5068. DOI 10.2139/ssrn.3526918.
- [5] Day, B. and Sigrimis, N. (2020) "An invited editorial interview with Professor Nick Sigrimis, Agricultural University of Athens, on Smart Agriculture and the digital revolution", *Biosystems Engineering*, Vol. 198, pp. 350-354. E-ISSN 1537-5129. DOI 10.1016/j.biosystemseng.2020.09.001.
- [6] Gaál, M., Molnár, A., Illés, I., Kiss, A., Lámfalusi, I. and Kemény, G. (2021) "Where do we stand with digitalization? An assessment of digital transformation in Hungarian agriculture (Chapter 11)", In: Ed. Bochtis, D., Achillas, C., Baniyas, G. and Lampridi, M. "*Bio-Economy and Agri-production*", Academic Press, pp. 195-206. ISBN 0128197749. DOI 10.1016/B978-0-12-819774-5.00011-4.
- [7] Geris, L., Lambrechts, T., Carlier, A. and Papantoniou, I. (2018) "The future is digital: In silico tissue engineering", *Current Opinion in Biomedical Engineering*, No. 6, pp. 92-98. E-ISSN 2468-4511. DOI 10.1016/j.cobme.2018.04.001.
- [8] Hopmann, C. and Schmitz, M. (2020) "Digital Engineering", In: "*Plastics Industry 4.0. Potentials and Applications in Plastics Technology*", pp. 175-220. ISBN 99781569907962. DOI 10.3139/9781569907979.006.
- [9] Jeske, T., Würfels, M. and Lennings, F. (2021) "Development of Digitalization in Production Industry – Impact on Productivity, Management and Human Work", *Proceedings of the 2nd International Conference on Industry 4.0 and Smart Manufacturing (ISM 2020)*, *Procedia Computer Science*, No. 180, pp. 371-380. E-ISSN 1877-0509. DOI 10.1016/j.procs.2021.01.358.
- [10] Judina, T.N. (2017) "Цифровизация Как Тенденция Современного Развития Экономики Российской Федерации: Pro Y Contra" (Digitalization as Modern Trend the Russian Federation Economy Pro et Contra), *State and Municipal Management. Scholar Notes*, No. 3, pp. 139-143. ISSN 2079-1690. DOI 10.23394/2079-1690-2017-1-3-139-143. (in Russian).
- [11] Kapelyuk, Z. A. and Aletdinova, A. A. (2017) "Основные Вызовы Развития Российского Аграрного Сектора Main Development" (Challenges of Russian Agricultural Sector), *The Far East Agricultural Bulletin*, Vol. 44, No. 4, pp. 198-203. ISSN 1999-6837. DOI 10.24411/1999-6837-2017-00113. (in Russian).
- [12] Kolomyts, O. N. and Ivanova, I. G. (2020) "Рус Интеграция Малых Форм Хозяйствования В Цифровую Агропродовольственную Экосистему Как Новый Вектор Эффективного Развития Сельских Аграрных Территорий Современной России" (Integration of Small Businesses into the Digital Agro-Food Ecosystem as a New Vector of Effective Development of Rural Agricultural Territories in Modern Russia), *Azimuth of Scientific Research: Economics and Administration*, Vol. 32, No. 3, pp. 191-194. ISSN 2309-1762. DOI 10.26140/anie-2020-0903-0042. (in Russian).
- [13] Lajoie-O' Malley, A., Bronson, K., Van der Burg, S. and Klerkx, L. (2020) "The future(s) of digital agriculture and sustainable food systems: An analysis of high-level policy documents", *Ecosystem Services*, Vol. 45. ISSN 2212-0416. DOI 10.1016/j.ecoser.2020.101183.

- [14] Maksimova, T. P. and Zhdanova, O. A. (2018) "Реализация Стратегии Цифровизации Агропромышленного Комплекса России: Возможности И Ограничения" (The Digitalization Strategy Implemented in the Russian Agro-Industrial Complex: Possibilities and Constraints), *Theory and Practice of Social Development*, Vol. 127, No. 9, pp. 63-67. ISSN 1815-4964. DOI 10.24158/tipor.2018.9.9. (in Russian).
- [15] Matthes, M. and Kunkel, S. (2020) "Structural change and digitalization in developing countries: Conceptually linking the two transformations", *Technology in Society*, Vol. 63. ISSN 0160-791X. DOI 10.1016/j.techsoc.2020.101428.
- [16] Mirolyubova, T. V., Karlina, T. V. and Nikolaev, R. S. (2020) "Цифровая Экономика: Проблемы Идентификации И Измерений В Региональной Экономике" (Digital Economy: Identification and Measurements Problems), *Economy of Region*, Vol. 16, No. 2, pp. 377-390. ISSN 2072-6414. DOI 10.17059/2020-2-4. (in Russian).
- [17] Mitrofanova, I. V., Chernova, O. A., Buyanova, M. E., Ivanov, N. P. and Mitrofanova I. A. (2019) "Import Substitution Potential of the Agricultural Complex of the South of Russia", In: Popkova E. and Ostrovskaya V. (eds.) "Perspectives on the Use of New Information and Communication Technology (ICT) in the Modern Economy", *ISC 2018, Advances in Intelligent Systems and Computing*, Vol. 726, pp. 817-838. ISBN 978-3-319-90835-9. DOI 10.1007/978-3-319-90835-9_94.
- [18] Mitrofanova, I. V., Chernova, O. A. and Patrakeeva, O. Yu. (2020) "Приоритетные Национальные Проекты Как Инструмент Социально-Экономической И Политической Модернизации Старопромышленных Регионов Юга России" (Priority National Projects as a Tool of Social, Economic and Political Modernization of Old Industrial Regions of the South of Russia), *Science Journal of Volgograd State University. History. Area Studies. International Relations*, Vol. 25, No. 5, pp. 213-233. ISSN 1998-9938. DOI 10.15688/jvolsu4.2020.5.17. (in Russian).
- [19] Nagy, H. and Káposzta, J. (2016) "Interpretation of land-use system in Hungary in the context of rural development", *Proceedings of the international scientific conference Engineering for Rural Development*, Latvia University of Agriculture, pp. 1330-1336. ISSN 1691-5976.
- [20] Nagy, H. and Siphesihle, N. (2021) "Blue Gold: Advancing Blue Economy Governance in Africa", *Sustainability*, Vol. 13, No. 13. E-ISSN 2071-1050. DOI 10.3390/su13137153.
- [21] Phillips, P., Relf-Eckstein, J.-A., Jobe, G. and Wixted, B. (2019) "Configuring the new digital landscape in western Canadian agriculture", *NJAS - Wageningen Journal of Life Sciences*, Vol. 90-91. ISSN 1573-5214. DOI 10.1016/j.njas.2019.04.001.
- [22] Pigford, A.-A. E., Hickey, G. M. and Klerkx, L. (2018) "Beyond agricultural innovation systems? Exploring an agricultural innovation ecosystems approach for niche design and development in sustainability transitions", *Agricultural Systems*, Vol. 164, pp. 116-121. ISSN 0308-521X. DOI 10.1016/j.agsy.2018.04.007.
- [23] Pschybilla, T. and Homann, A. (2020) "Evaluation of end-to-end process and information flow analyses through digital transformation in mechanical engineering", *Procedia CIRP*, No. 93, pp. 298-303. ISSN 2212-8271. DOI 10.1016/j.procir.2020.04.070.
- [24] Rijswijk, K., Klerkx L. and Turner, J. A. (2019) "Digitalisation in the New Zealand Agricultural Knowledge and Innovation System: Initial understandings and emerging organisational responses to digital agriculture", *NJAS - Wageningen Journal of Life Sciences*, Vol. 90-91. ISSN 1573-5214. DOI 10.1016/j.njas.2019.100313.
- [25] Rose, D. C. and Chilvers, J. (2018) "Agriculture 4.0: broadening responsible innovation in an era of smart farming", *Frontiers in Sustainable Food Systems*, Vol. 2. E-ISSN 2571-581X. DOI 10.3389/fsufs.2018.00087.
- [26] Roux, N., Kastner, T., Erb, K.-H. and Haberl, H. (2021) "Does agricultural trade reduce pressure on land ecosystems? Decomposing drivers of the embodied human appropriation of net primary production", *Ecological Economics*, Vol. 181. ISSN 0921-8009. DOI 10.1016/j.ecolecon.2020.106915.

- [27] Shah, S. M., Liu, G., Yang, Q., Wang, X., Casazza, M., Agostinho, F., Lombardi, G. V. and Giannetti, B. F. (2019) "Emergy-based valuation of agriculture ecosystem services and dis-services", *Journal of Cleaner Production*, Vol. 239. E-ISSN 1879-1786. DOI 10.1016/j.jclepro.2019.118019.
- [28] Shelkovnikov, S. A., Petukhova, M. S. and Alekseev, A. A. (2020) "Theoretical bases of managing agricultural production based on digital technologies", *RUDN Journal of Economics*, Vol. 28, No. 1, pp. 137-145. ISSN 2313-2329. DOI 10.22363/2313-2329-2020-28-1-137-145.
- [29] Toguzayev, T. K., Rakhaev, K. M. and Modebadze, N. P. (2020) "Evolution of Forms, Methods and Mechanisms of integration in Agriculture", Russia: Tendencies and Perspectives of Development: Annual; *XI International Research-to-Practice Conference "Regions of Russia; Strategies of Development and Mechanisms of Realization of Priority National Projects and Programs"*; Kursk, 5-6 June 2020, Moscow. Institute of Scientific Information on Social Sciences RAS, pp. 291-295. ISBN 978-5-248-00970-1.
- [30] Tsirenschikov, V. S. (2019) "Цифровизация Экономики Европы" (Digitalization of European Economy), *Modern Europe*, Vol. 88, No. 3, pp. 104-113. ISSN 0201-7083. DOI 10.15211/soveurope32019104113. (in Russian).
- [31] Ungaro, F., Schwartz, C. and Piorr, A. (2021) "Ecosystem services indicators dataset for the utilized agricultural area of the Märkisch-Oderland District-Brandenburg, Germany", *Data in Brief*, Vol. 34. E-ISSN 2352-3409. DOI 10.1016/j.dib.2020.106645.
- [32] Vishnevskiy, K. O., Gokhberg, L. M., Dementjev, V. V., Dranev, Y. Y., Klubova, M. A., Kotsemir, M. N., Kuzminov, I. F., Lola, I. S., Privorotskaya, S. G., Rudnik, P. B., Sokolov, A. V., Streltsova, E. A., Turovets, Y. V., Fursov, K. S., Khabirova, E. E., Altynov, A. I., Evtushenko, V. E., Kuchin, I. I. and Lobanova, P. A. (2021) "Цифровые Технологии В Российской Экономике" (*Digital Technologies in Russian Economy*), Ed. Gokhberg, L. M., Vishnevsky, K.O., Parshin, M.V. and Rudnik, P. B., Moscow, Higher School of Economics. ISBN 978-5-7598-2199-1. DOI 10.17323/978-5-7598-2199-1. (in Russian).
- [33] Wilhelm, J. A., Smith, R. G., Jolejole-Foreman, M.-C. and Hurley, S. (2020) "Resident and stakeholder perceptions of ecosystem services associated with agricultural landscapes in New Hampshire", *Ecosystem Services*, Vol. 45. ISSN 2212-0416. DOI 10.1016/j.ecoser.2020.101153.
- [34] Zhong, L., Wang, J., Zhang, X. and Ying, L. (2020) "Effects of agricultural land consolidation on ecosystem services: Trade-offs and synergies", *Journal of Cleaner Production*, Vol. 264. E-ISSN 1879-1786. DOI 10.1016/j.jclepro.2020.121412.

Regional Impacts of Direct Payments on Farm Productivity and Efficiency in the European Union

Attila Jambor, Akos Szerletics

Department of Agricultural Economics and Rural Development, Corvinus University of Budapest, Hungary

Abstract

This paper analyses the regional impacts of direct payments on the labour and land productivity of European farms. The basic assumption of the research is that direct CAP subsidies have a positive effect on productivity and efficiency. This was tested by quantitative regression-analysis models, which were based on NUTS2-level regional data from 2008-2018. The results show that direct subsidies have a negative effect on labour and productivity in agriculture, a finding that can be attributed to a number of underlying factors. The direction and magnitude of these productivity effects differ markedly between old and new Member States.

Keywords

Direct payment, CAP, regional, effect, land productivity, labour productivity.

Jambor, A. and Szerletics, A. (2022) "Regional Impacts of Direct Payments on Farm Productivity and Efficiency in the European Union", *AGRIS on-line Papers in Economics and Informatics*, Vol. 14, No. 1, pp. 59-68. ISSN 1804-1930. DOI 10.7160/aol.2022.140105.

Introduction

The Common Agricultural Policy (CAP) is one of the key policies of the European Union, encouraging the development of the European agricultural economy, the renewal of rural areas and the achievement of certain environmental and climate protection objectives through its diversified support system and market regulation instruments. CAP resources accounted for about 36% of the EU's 2018 budget. The most significant CAP subsidies are the so-called direct payments, which are generally available to farmers based on the size of their land or livestock. Direct payments are income-transfer measures aimed at strengthening agricultural production, stabilising farmers' incomes, contributing to the production of safe food, and compensating farmers for the preservation of certain public goods (such as nature protection and landscape conservation) (European Commission, 2020).

In the 2018 grant year, a total of € 41.74 billion of CAP direct aid was disbursed to 6.38 million beneficiaries across Europe. This clearly illustrates the importance of direct payments in the life of the European agricultural economy (European Commission, 2020).

Because of their magnitude and importance,

the economic impacts of direct payments have naturally been the focus of scientific analysis (see e.g. World Bank, 2018; Latruffe, 2017, Ciaian, 2015). Our present research aims to look at the regional impacts of direct payments on the labour and land productivity of European farms, via the quantitative analysis of NUTS2 regional data from 2008 to 2018. Current regional-level data allow for a more detailed level of modelling than the examination of aggregated data by country. This is the main contribution of this paper to the existing literature.

The paper is structured as follows. Section 2 provides a literature review, while Section 3 demonstrates our methodological approach. Section 4 shows the results of our model runs, followed by a discussion. The last section is the conclusion.

Literature review

The effect of the CAP on the productivity and efficiency of farms is a subject extensively studied in the literature. For instance, Zhu et al. (2012) studied the effects of CAP direct payments on the technical efficiency of German, Dutch and Swedish dairy farms between 1995 and 2004. Their results show that increasing the percentage of direct subsidies within the total agricultural income of farms has led to lower technical efficiency

in all the countries concerned. Furthermore, coupled support had an additional negative effect on technical efficiency in Germany and the Netherlands (but no significant effect in Sweden), compared with decoupled support. This suggests that the motivation of farmers to innovate and work more efficiently is reduced when they become increasingly dependent on subsidies as a source of income. In another article on the same subject (Zhu et al., 2010), the authors found the highest level of efficiency in the Netherlands, followed by Sweden and Germany. In all three countries, farm sizes and degrees of farm specialisation were positive contributors to technical efficiency, while the share of agricultural subsidies in total income was a negative contributor.

Further studies also suggest a negative effect on farm efficiency. Using microeconomic data from the Polish Farm Accountancy Data Network (FADN) on 1212 dairy farms over the period 2004-2011, Marzec and Pisulewski (2017) estimated the translog production function in order to measure the effect of CAP subsidies on technical efficiency of farms. A stochastic frontier analysis revealed that although there was some technical development in the study period among Polish dairy farms, CAP subsidies on the whole had a negative influence on efficiency.

Mary (2013) also arrived at a similar conclusion. FADN data for 1529 French crop farms for the period 1996-2003 were used to assess the impact of the CAP on total factor productivity, by estimating a production function based on the generalized method of moments approach. The calculations showed that CAP measures that were more or less automatically granted to farmers on a per-hectare or per-animal basis had a significant negative effect on the productivity of farms. However, selective measures such as investment or environmental support had no significant effect, while the decoupling of direct payments seems to have had a positive influence on farm efficiency.

Latruffe et al. (2017) also examined the association between CAP subsidies and the technical efficiency of European dairy farms by using FADN data from nine EU countries for the period 1990-2007. On this basis, a stochastic production frontier was estimated with the method of moments, to account for possible endogeneity issues. The analysis produced mixed results: direct payments influenced technical efficiency positively in two study countries and negatively in two other countries, while

no effect was detectable in the others. Furthermore, it was shown that decoupling did not change the direction in which CAP support influences technical efficiency, but it generally reduces its magnitude (when compared with coupled payments).

Based on the above-mentioned articles, one can arrive at the general conclusion that CAP direct payments tend to lower the efficiency of farms. However, it seems that the decoupling of payments can somewhat alleviate this undesirable policy effect. For example, Rizov et al. (2013) estimated the impact of the CAP on total farm productivity using a structural semi-parametric procedure. Data from the FADN for a large sample of farms from the EU-15 countries for the period 1991-2008 served as basis for the calculations. Total productivity was aggregated by country and farm type. The results showed that in the years before the 2003 decoupling of direct payments, the subsidies had a negative effect on the productivity of farms. After decoupling, however, the situation became somewhat mixed; in some countries, the effect on productivity even became positive. These empirical findings are in line with the theoretical background: in general, subsidies distort market conditions and therefore lower the efficiency of farms. On the other hand, decoupled direct support is less distortive and therefore has a more positive (or less negative) effect on farm productivity.

Decoupling was also the focus of a study performed by Kazukauskas et al. (2010), which explored the effect of decoupling on the productivity of Irish dairy farms. Using national farm survey data for the period 2001-2007, a productivity estimation model was set up based on the Olley and Pakes approach as well as on stochastic frontier analysis. The models controlled for the significant capital investment grants in the study period, and for the increased price volatility caused by the uncertainties associated with decoupling. With the exclusion of these effects, the models found a significant and positive relationship between decoupling and total productivity in the dairy sector.

In a similar study on the same subject (Kazukauskas et al., 2014), the authors used Irish, Danish and Dutch farm-level data from national agricultural surveys in the period 2001-2007. Again, they found a positive relationship between decoupling and farm productivity, which was especially significant in the case of Ireland. Moreover, decoupling

seemed to alter farmers’ choices on specialisation, in the sense that they moved towards more productive farming activities.

Note has to be taken that while the majority of studies detect a negative relationship between direct payments and efficiency, there are some exceptions. Cillero et al. (2018) performed a stochastic frontier analysis to measure the effect of direct payment on the technical efficiency of Irish beef farms. Their calculations were based on panel farm-level data from the FADN for the period 2000-2013. Their analysis revealed low overall technical efficiency in the Irish beef sector. The situation improved from 2000 to 2007, but from 2008 to 2012 a slight decline was detectable. In contrast to the general findings of other studies, it was shown that the effect of direct payments on technical efficiency was positive. In a similar article, Cillero

et al. (2019) analysed technological heterogeneity in the Irish beef sector and, by applying a latent class stochastic frontier model, they again found that decoupled direct payments had significant positive effects on technologically advanced farms.

The reviewed articles analysing the effects of direct payments on technical efficiency are summarised in Table 1.

Most studies into the subject of technical efficiency established a negative relationship between direct payments and productivity. Being a relatively stable source of income, direct support does not incentivise farmers towards innovation, newer technologies, reorganisation of economic activities or investment. Coupled support seems to be especially disadvantageous in this regard, as it influences and distorts production decisions

Author	Topic	Country	Method	Result
Zhu et al. (2012)	Effects of CAP direct payments on technical efficiency of farms	Germany Sweden Netherlands	Inefficiency Effects Model	Higher percentage of direct subsidies within total agricultural income of farms leads to lower technical efficiency in all countries concerned. Coupled support had an additional negative effect (compared with decoupled support).
Zhu et al. (2010)	Effects of CAP direct payments on technical efficiency of farms	Germany Sweden Netherlands	Inefficiency Effects Model	Positive contributors to technical efficiency are farm size and levels of farm specialization. The share of agricultural subsidies in total income is a negative contributor in all three countries.
Marzec and Pisulewski (2017)	Study of technical efficiency of Polish farms	Poland	Stochastic frontier analysis	Although there was some technical development in the study period among Polish dairy farms, CAP subsidies on the whole had a negative influence on efficiency.
Mary (2013)	Impact of CAP on total factor productivity	France	Generalized method of moments	CAP measures that are automatically granted to farmers on a per hectare basis had a negative effect on productivity. Decoupling can offset this effect to a certain extent.
Latruffe et al. (2017)	Association between CAP subsidies and farm technical efficiency	Several Member States	Stochastic frontier analysis	Direct payments influenced technical efficiency positively in two study countries, negatively in two other countries, while no effect was detectable in others.
Rizov et al. (2013)	Effect of decoupling on productivity	Old Member States (EU-15)	Structural semi-parametric estimation procedure	Decoupled direct support is less distortive and therefore has a more positive (or less negative) effect on farm productivity than coupled support.
Kazukauskas et al. (2010)	Effect of decoupling on productivity	Ireland	Stochastic frontier analysis	There is a significant and positive relationship between decoupling and total productivity in the dairy sector.
Kazukauskas et al. (2014)	Effect of decoupling on productivity	Ireland Denmark Netherlands	Stochastic frontier analysis	Decoupling seems to alter farmers’ production choices: a shift towards more productive farming activities was detected.
Cillero et al. (2018, 2019)	CAP policy effects on efficiency	Ireland	Stochastic frontier analysis	Decoupled payments decrease production risks and therefore aid farm investments, which can raise technical efficiency levels.

Source: own composition

Table 1: Effects of direct payments on productivity/efficiency of farms.

to a greater extent. Decoupling, on the other hand, appears to make its best contribution when it comes to tackling issues related to productivity. The reviewed articles unanimously underline that decoupling has a beneficial effect on the technical efficiency of farms. This can alleviate, but not eliminate, negative policy effects.

Materials and methods

Based on the literature above, the following hypotheses were tested:

H1. Direct payments increase the productivity of agricultural labour at regional level.

H2. Direct payments increase the productivity of agricultural land at regional level.

In order to test these hypotheses, changes in land and labour productivity were measured by using regional agricultural productivity data, proxied as quotients of regional agricultural value added for land as well as labour. A positive link is expected, namely that direct payments will increase agricultural productivity. Data on the volume of direct payments are from the Clearance Audit Trail System (CATS) database. The database is operated by the European Commission and records all payments made under any CAP support on an annual basis and by beneficiary. The data are reported to the Commission by the Member States each year, and form the basis for the financial accounting between the Commission and the Member States. The data on other variables were downloaded from the Annual Regional Database of the European Commission (ARDECO), the EU Statistics on Income and Living Conditions (EU-SILC), and the Eurostat database.

Based on these data, a classic ex-post impact analysis was carried out, in line with the research strategy used by Bojnec and Fertő (2019), Ciaian et al. (2015), Galluzzo (2018), Kilian et al. (2012), Klaiber et al. (2017), Tangermann (1998), and others.

For the different model runs, a number of control variables, in line with the literature (World Bank Group, 2018; Garonne et al., 2019), were also used as evidence in the following equations:

$$\begin{aligned} \ln\text{LABOURPROD}_{it} = & \alpha_0 + \alpha_1 \ln\text{DP}_{it} + \\ & + \alpha_2 \ln\text{INCRATIO}_{it} + \alpha_3 \ln\text{AGGVA}_{it} + \\ & + \alpha_4 \ln\text{NONAGGVA}_{it} + \alpha_5 \ln\text{SALARIES}_{it} + \\ & + \alpha_6 \ln\text{POPDENS}_{it} + \alpha_7 \ln\text{GFCF}_{it} + \\ & + \alpha_8 \text{CONVERGENCE} + v_{it} + \varepsilon_{it} \end{aligned} \quad (1)$$

$$\begin{aligned} \ln\text{LANDPROD}_{it} = & \alpha_0 + \alpha_1 \ln\text{DP}_{it} + \\ & + \alpha_2 \ln\text{ENTREINCOME}_{it} + \alpha_3 \ln\text{GDP}_{it} + \\ & + \alpha_4 \ln\text{GDPPERHEAD}_{it} + \alpha_5 \ln\text{NONAGGVA}_{it} + \\ & + \alpha_6 \ln\text{AGEMPL}_{it} + \alpha_7 \ln\text{HHINCOME}_{it} + \\ & + \alpha_8 \ln\text{SALARIES}_{it} + \alpha_9 \ln\text{POPDENS}_{it} + \\ & + \alpha_{10} \ln\text{GFCF}_{it} + \alpha_{11} \text{CONVERGENCE} + \\ & + v_{it} + \varepsilon_{it} \end{aligned} \quad (2)$$

To test each hypothesis, random effects panel regression models were used. As shown in the equations above, a logarithmic version of the variables was utilized – where applicable – to show percentage effects. In each case, models were tested for all Member States and then separately for the old and new Member States.

As there are relatively numerous, significant control variables present in the equations, it was presumed that unobserved heterogeneity does not cause correlation between the error term and the explanatory variables. Furthermore, Variance Inflation Factor tests for multicollinearity did not detect a high level of correlation between independent variables.

Table 2 provides a summary of the variables used.

All the data for the variables in Table 2 are available for NUTS2 regions. Data are also broken down by year, covering the period 2008-2018. However, data for some variables are not available for each year.

The names and codes of the regions are included according to the NUTS 2016 nomenclature. Out of a total of 281 NUTS2 regions, 244 regions are included in the database. The other regions were excluded from the scope of the analysis due to lack of data, or due to the fact that the area of the given region changed during the analysis period (through being merged with several regions or split into several regions), so the data for them could not be used validly.

After a uniform alignment of the values of the variables from the different data sources, a strongly balanced panel database was developed. The values of each variable can be characterised by the following descriptive statistics (Table 3).

We are aware of the limitations of our research design. First, it is clear from the structure of the Common Agricultural Policy that not only direct payments but also other forms of support (agri-environment, less-favoured areas, etc.) can have productivity or efficiency impacts. Second, there are other effects (e.g., farm structure, production structure) that are not examined in this article. Third, it is also clear that other methodological approaches (for example, stochastic frontier analysis, data envelopment analysis) may

Variable name	Description of variable	Unit of measure	Data source
LNLANDPROD	Productivity of agricultural land: agricultural GVA divided by the utilized agricultural area (UAA)	million PPS/hectare	derived statistic
LNLABOURPROD	Productivity of agricultural labour: agricultural GVA divided by agricultural employment	million PPS/thousand persons	derived statistic
LNDP	The logarithm of the number of direct payments	€	CATS
INCRATIO	Rate of agricultural income compared to total household income	ratio (from 0 to 1)	derived statistic
LNAGGVA	The logarithm of Gross Value Added in the agricultural sector (GVA), current prices	million PPS	ARDECO
LNNONAGGVA	The logarithm of Gross Value Added in all sectors outside agriculture (GVA), current prices	million PPS	ARDECO
LNSALARIES	The logarithm of salaries of persons working in agriculture	million PPS	ARDECO
LNPOPDENS	The logarithm of population density	persons/square kilometre	Eurostat
LNGFCF	The logarithm of Gross Fixed Capital Formation (GFCF) in agriculture, current prices	million €	ARDECO
LNENTREINCOME	The logarithm of income of agricultural holdings	million €	Eurostat
LNGDP	The logarithm of Gross Domestic Product (GDP), current prices	million PPS	ARDECO
LNGDPPERHEAD	The logarithm of GDP/capita	PPS	ARDECO
LNAGEMPL	The logarithm of agricultural employment	thousand persons	ARDECO
LNHHINCOME	The logarithm of household income (non-agricultural)	million €	Eurostat
CONVERGENCE	Regions eligible for financing from the European Regional Development Fund, or the European Social Fund (convergence regions)	0 – non-convergence region; 1 – convergence region	Implementing decision of the European Commission, 18 February 2014
UAA	Utilized agricultural area	hectares	Eurostat

Source: own composition

Table 2: provides a summary of the variables used.

Variable name	Number of observations	Mean	Standard deviation	Minimum	Maximum
LNLANDPROD	2 684	0.21	0.74	-3.79	3.06
LNLABOURPROD	2 684	-3.03	0.84	-9.07	-0.76
LNDP	2 683	18.26	1.23	12.13	21.20
INCRATIO	1 891	0.02	0.03	-0.03	0.23
LNAGGVA	2 684	6.22	1.11	0.81	9.27
LNNONAGGVA	2 684	10.28	0.93	6.70	13.30
LNSALARIES	2 440	4.87	1.08	0.10	7.54
LNPOPDENS	2 637	5.02	1.13	0.99	8.92
LNGFCF	2 439	5.18	1.04	0.80	7.77
LNENTREINCOME	1 661	5.24	1.22	0.00	9.12
LNGDP	2 684	10.42	0.91	6.85	13.42
LNGDPPERHEAD	2 684	10.1	0.38	8.82	11.29
LNAGEMPL	2 684	2.97	1.26	-2.3	6.72
LNHHINCOME	2 466	9.97	1.00	6.55	12.86
CONVERGENCE	2 684	0.27	0.44	0.00	1.00
UAA	2 684	646.58	659.12	7.01	4 643.46

Source: own composition

Table 3: Main descriptive statistics of the model variables.

lead to different results. However, the chosen methodology has been used by a large number of researchers in this subject.

Results and discussion

According to our hypotheses, direct payments increase regional agricultural productivity in the European Union. The results of the models for agricultural labour productivity are detailed in the Table 4. The model was first run on all Member States' data, and then also on the data of old and new Member States, separately.

(Please note that the number of observations used by the models is smaller than the total number of observations indicated in Table 3. This is due to the fact that the model only runs on observations where the values of all regression variables are jointly present, which is not always the case.)

The results of the model contradict our hypothesis: direct subsidies have a negative effect on labour productivity in agriculture. With a 1% increase in direct payments, the labour productivity indicator will deteriorate by 0.016%, which means a lower agricultural value added (GVA) produced by a thousand people. The result is consistent with Zhu et al. (2010, 2012), Marzec and Pisulewski (2017), Mary (2013) and Latruffe et al. (2017), by examining the technical efficiency of farms in general and showing a negative relationship

between productivity and the level of direct subsidies.

The negative effects of direct subsidies on efficiency are due to the following factors (Zhu et al., 2012):

- Direct subsidies are a stable source of income, increasing the income realised from agricultural activity, regardless of how technically efficient the production process is. In this way, farmers may become interested in sub-optimal production activities, thus reducing efficiency.
- Due to their stable nature, direct payments distort farmers' risk perceptions and preferences, which affect their production activities and often encourage them to be less efficient.
- Coupled support is particularly disadvantageous in terms of efficiency, as it can encourage farmers to produce goods that cannot be produced particularly efficiently under the given circumstances.

For all these reasons, direct payments do not encourage farmers to innovate, to develop new technologies, to invest or to restructure economic activities. This way, producers' efficiency efforts decline, and the phenomenon of wastage of factors of production, such as agricultural labour, emerges (Bakucs et al., 2010).

Dependent variable: labour productivity	all Member States	old Member States	new Member States
Amount of direct payments	-0.016** (0.008)	0.012 (0.009)	-0.663** (0.028)
Agricultural GVA	0.044*** (0.015)	0.008 (0.017)	0.208*** (0.04)
Non-agricultural GVA	-0.244*** (0.033)	-0.180*** (0.041)	-0.441*** (0.089)
Population density	0.379*** (0.045)	0.316*** (0.049)	0.06 (0.156)
Agricultural GFCF	0.036*** (0.011)	0.049*** (0.012)	0.024 (0.029)
Agricultural salaries	0.046*** (0.016)	0.110*** (0.024)	0.007 (0.025)
Income ratio	-0.655*** (0.25)	-1.201*** (0.407)	-0.582 (0.374)
Convergence region	-2.967*** (0.324)	0.488*** (0.16)	-0.660* (0.35)
Constant term	-2.967*** (0.324)	-3.992*** (0.374)	1.74 (1.079)
Number of observations	1842	1539	303
Number of regions	214	182	32
R squared	0.211	0.232	0.061

Source: own composition

Table 4: Impacts of direct payments on labour productivity – model results.

Furthermore, the introduction of a maximum ceiling for direct payments (a support amount beyond which no payment can be made to a single beneficiary) has led to the splitting up of large farms into smaller, therefore less competitive units. This also acts against technical efficiency (Szerletics, 2018).

The coefficients of certain control variables were as follows:

- The use of gross fixed assets in agriculture (GFCF) has a positive effect on labour productivity. This is because in the model, the degree of fixed asset accumulation reflects productive investments (such as the purchase of agricultural machinery and equipment) that increase the efficiency of production.
- The level of agricultural wages also has a positive effect on labour productivity, presumably because the amount of wages paid suggests not only the quantity but also the quality of the labour used, which increases efficiency.

- Convergence regions are less economically developed regions of the Union, so it is not surprising that the model for such regions has shown overall lower labour productivity.
- As the population density decreases, agricultural labour productivity also decreases. Presumably this is due to the shrinking labour supply in sparsely populated areas of the Union.

There is an interesting difference between the old and new Member States. While the regression model run on data from the old Member States did not find a significant correlation between direct payments and labour productivity, a significant negative effect could be identified in the new Member States. These findings indicate that direct payments do not seem to have affected labour productivity in the old Member States, but they have negatively affected labour productivity in the new ones.

The results of the model for agricultural land productivity are detailed in the Table 5.

Dependent variable: land productivity	all Member States	old Member States	new Member States
Amount of direct payments	-0.081*** (0.018)	-0.069** (0.028)	-0.04 (0.037)
Agricultural employment	0.098*** (0.029)	0.081** (0.034)	-0.012 (0.069)
Agricultural income	0.114*** (0.008)	0.111*** (0.034)	0.099*** (0.018)
GDP	3.296*** (0.27)	3.272*** (0.316)	4.033*** (0.587)
GDP/capita	1.006*** (0.073)	0.977*** (0.087)	0.902*** (0.233)
Agricultural GFCF	0.277*** (0.018)	0.346*** (0.02)	0.009 (0.039)
Non-agricultural income	-0.326*** (0.057)	-0.344*** (0.069)	-0.153 (0.123)
Non-agricultural GVA	-3.562*** (0.274)	-3.613*** (0.322)	-4.089*** (0.512)
Population density	0.485*** (0.04)	0.537*** (0.043)	0.425*** (0.126)
Agricultural salaries	0.174*** (0.023)	0.230*** (0.033)	0.103*** (0.033)
Convergence region	-0.248*** (0.093)	-0.237* (0.129)	-0.105 (0.238)
Constant term	-8.528*** (0.608)	-8.297*** (0.925)	-9.507*** (1.395)
Number of observations	1562	1284	278
Number of regions	193	161	32
R squared	0.535	0.559	0.558

Source: own composition

Table 5: Impacts of direct payments on the productivity of land – model results.

The results of the model run counter to our original expectation: direct payments have a negative impact on agricultural productivity of arable land. With a 1% increase in direct payments, the land productivity indicator will deteriorate by 0.08%, i.e., the agricultural value added (GVA) per hectare.

The negative link between the productivity of agricultural land and direct payments occurs because farmers receive payments mainly according to the amount of the agricultural land they use. (Although there are some livestock-based direct payments, most payments are calculated on an area basis.) To maximise direct support amounts, farmers are therefore interested in securing as much agricultural land as possible for their own use. There are basically two ways to achieve this:

- more land is bought or leased, and market demand for agricultural land increases accordingly (Constantin et al., 2017);
- previously unused land is also brought into agricultural production. In doing this, farmers may also involve marginal, inferior land in production, merely to establish their entitlement to direct payment. The standard of agricultural production in these areas lags behind that of better-quality land, and consequently productivity decreases.

In addition to the deterioration of the quality of the land, the decrease in productivity may also be exacerbated by the fact that direct subsidies, which can be considered a more or less guaranteed income element, do not contribute to the efficiency and innovation of agricultural production technology (Zhu et al., 2012). It is interesting to note that in extreme cases the increased demand for agricultural land may culminate in the phenomenon of “land grabbing”. In this context, investors embark on large-scale land acquisitions, which upset traditional land use conditions and lead to high levels of land concentration, resulting in possible social tensions and environmental problems. “Land grabbing” is a well-known phenomenon in many regions of the world, driven by several market factors. One such factor in Europe is CAP area-based direct support, which contributes to increased pressure in the agricultural land market (Kay, 2016).

Regarding the coefficient of certain control variables, it can be asserted that the use of gross fixed assets in agriculture has a positive effect on the productivity of agricultural land. This is consistent with the results of the labour productivity

model; fixed asset investment generally aids technological advancement and thus increases the efficiency of the use of factors of production. The variable representing convergence regions also had a negative coefficient in this model, in line with preliminary theoretical expectations. The impact on land productivity is negative in the old Member States, while being not significantly different from zero in the new Member States. Interestingly, this is the opposite of what has been shown in terms of labour productivity. On the one hand, this may be due to the fact that the old Member States have higher levels of direct aid per hectare than the new Member States on average. Thus, there is more incentive for farmers to include less productive land in production because the higher amounts of direct support compensate for the possible losses. On the other hand, in the new Member States, there is a larger area of relatively productive land that can be involved in agricultural production (Constantin et al., 2017). Therefore, the inclusion of new land in the new Member States does not lead to the same reduction in productivity as in the old Member States.

At the same time, it is important to stress that the phenomenon of “land grabbing” is much more prevalent in the new Member States overall than in the old ones, because the price of agricultural land is much lower in the new Member States. At the same time, the decline in land productivity related to CAP direct payments is still lower in the new Member States.

Conclusion

The results of the analysis showed that direct subsidies have a negative effect on labour productivity in agriculture. The result is in line with the findings of previous research, which generally showed a negative relationship between productivity and levels of direct support. The effect is mainly due to the fact that direct payments are a stable source of income, increasing the income realized from agricultural activity, regardless of how technically efficient the production process may be. Direct payments therefore do not encourage farmers to innovate and reorganise their economic activities, so that factors of production, such as agricultural labour, may be used in an irrational, wasteful way.

Likewise, a negative correlation was identified between direct payments and agricultural land productivity. This is due to the fact that farmers receive payments primarily on the basis

of the size of the agricultural land used, which increases the demand for land. Farmers buy or rent more land, or involve marginal, less productive land in production, leading to reduced efficiency.

The direction and magnitude of these productivity effects differ markedly between the old and new Member States. CAP direct payments seem to influence labour productivity in a negative way in new Member States, while no significant effect is detected on land productivity in these countries. This may be due to the fact that in the new Member States, there is a larger area of productive land that can be newly included in agricultural production; therefore, the productivity of agricultural land does not decline as the demand for it increases due to CAP direct support.

The results of the research may have interesting policy implications. In the light of the findings, a shift from direct income support towards insurance premium subsidies and income stabilization instruments could be advisable.

These policy tools could respond to the criticisms of productivity and technological efficiency made against direct subsidies. Direct support is a fixed income supplement for the farmer, regardless of how efficiently they handle resources and production factors, and how much they encourage technological development and innovation. However, in the framework of income stabilization instruments, if the beneficiary was able to operate more efficiently and productively in the previous period, thereby increasing their agricultural income, the increased income reference would be the basis for support in the future. In this way, farmers could become more interested in efficient operation and increasing competitiveness.

Further research may analyse other impacts direct payments may have on regional data, or may use other variables to explain the relationships described above in a deeper way.

Corresponding authors

Prof. Attila Jambor

Department of Agricultural Economics and Rural Development

Corvinus University of Budapest, Fővám tér 8, 1093-Budapest, Hungary

E-mail: attila.jambor@uni-corvinus.hu

References

- [1] Bakucs, L., Latruffe, L., Fertő, I. and Fogarasi, J. (2010) "The impact of EU accession on farms' technical efficiency in Hungary", *Post-Communist Economies*, Vol. 22, pp. 165-175. ISSN 1463-1377. DOI 10.1080/14631371003740639.
- [2] Bojnec, Š. and Fertő, I. (2019) "Do CAP subsidies stabilise farm income in Hungary and Slovenia?", *Agricultural Economics (Czech Republic)*, Vol. 65, pp. 103-111. ISSN 0139-570X. DOI 10.17221/190/2018-AGRICECON.
- [3] Ciaian, P., Kancs, d'A. and Gomez y Paloma, S. (2015) "Income distributional effects of CAP subsidies: Micro evidence from the EU", *Outlook on Agriculture*, Vol. 44, pp. 19-28. ISSN 0030-7270. DOI 10.5367/oa.2015.0196.
- [4] Cillero, M. M., Thorne, F., Wallace, M. and Breen, J. (2019) "Technology heterogeneity and policy change in farm-level efficiency analysis: an application to the Irish beef sector", *European Review of Agricultural Economics*, Vol. 46, No. 2, pp. 193-214. ISSN 0165-1587. DOI 10.1093/erae/jby028.
- [5] Cillero, M. M., Thorne, F., Wallace, M., Breen, J. and Hennessy, T. (2018) "The Effects of Direct Payments on Technical Efficiency of Irish Beef Farms: A Stochastic Frontier Analysis", *Journal of Agricultural Economics*, Vol. 69, No. 3, pp. 669-687. ISSN 0021-857X. DOI 10.1111/1477-9552.12259.
- [6] Constantin C., Luminita, C. and Vasile, A. J. (2017) "Land grabbing: A review of extent and possible consequences in Romania", *Land Use Policy*, Vol. 62, pp. 143-150. ISSN 0264-8377. DOI 10.1016/j.landusepol.2017.01.001.
- [7] European Commission (2020) "*The Common Agricultural Policy at a glance*". [Online]. https://ec.europa.eu/info/food-farming-fisheries/key-policies/common-agricultural-policy/cap-glance_en Brussels, Belgium. [Accessed: 12 March 2021].

- [8] Galluzzo, N. (2018) "Impact of the Common Agricultural Policy payments towards Romanian farms", *Bulgarian Journal of Agricultural Science*, Vol. 24, No. 2, pp. 199-205. ISSN 1310-0351.
- [9] Garrone, M., Emmers, D., Lee, H., Olper, A. and Swinnen, J. (2019) "Subsidies and agricultural productivity in the EU", *Agricultural Economics*, Vol. 50, No. 6, pp. 803-817. ISSN 0169-5150. DOI 10.1111/agec.12526.
- [10] Kay, S. (2016) "*Land grabbing and land concentration in Europe*", Transnational Institute, Amsterdam, Netherlands. [Online]. https://www.tni.org/files/publication-downloads/landgrabbingeurope_a5-2.pdf [Accessed: 5 Feb. 2021].
- [11] Kazukauskas, A., Newman, C. and Sauer, J. (2014) "The impact of decoupled subsidies on productivity in agriculture: a cross-country analysis using microdata", *Agricultural Economics*, Vol. 45, No. 3. pp. 327-336. ISSN 0169-5150. DOI 10.1111/agec.12068.
- [12] Kazukauskas, A., Newman, C. and Thorne, F. S. (2010) "Analysing the Effect of Decoupling on Agricultural Production: Evidence from Irish Dairy Farms using the Olley and Pakes Approach", *German Journal of Agricultural Economics*, Vol. 59, pp. 144-157. ISSN 0002-1121. DOI 10.22004/ag.econ.145290.
- [13] Kilian, S., Antón, J., Salhofer, K. and Röder, N. (2012) "Impacts of 2003 CAP reform on land rental prices and capitalization", *Land Use Policy*, Vol. 29, No. 4, pp. 789-797. ISSN 0264-8377. DOI 10.1016/j.landusepol.2011.12.004.
- [14] Klaiber, H. A., Salhofer, K. and Thompson, S. R. (2017) "Capitalisation of the SPS into Agricultural Land Rental Prices under Harmonisation of Payments", *Journal of Agricultural Economics*, Vol. 68, pp. 710-726. ISSN 0021-857X. DOI 10.1111/1477-9552.12207.
- [15] Latruffe, L., Bravo-Ureta, B. E., Carpentier, A., Desjeux, Y. and Moreira, V. H. (2017) "Subsidies and technical efficiency in agriculture: Evidence from European dairy farms", *American Journal of Agricultural Economics*, Vol. 99, No. 3, pp. 783-799. ISSN 0002-9092. DOI 10.1093/ajae/aaw077.
- [16] Mary, S. (2013) "Assessing the Impacts of Pillar 1 and 2 Subsidies on TFP in French Crop Farms", *Journal of Agricultural Economics*, Vol. 64, No.1, pp. 133-144. ISSN 0021-857X. DOI 10.1111/j.1477-9552.2012.00365.x.
- [17] Marzec, J. and Pisulewski, A. (2017) "The effect of CAP subsidies on the technical efficiency of Polish dairy farms", *Central European Journal of Economic Modelling and Econometrics*, Vol. 9, No. 3, pp. 243-273. ISSN 2080-0886.
- [18] Rizov, M., Pokrivcak, J. and Ciaian, P. (2013) "CAP subsidies and productivity of the EU farms", *Journal of Agricultural Economics*, Vol. 64, No. 3, pp. 537-557. ISSN 0021-857X. DOI 10.1111/1477-9552.12030.
- [19] Szerletics, Á. (2018) "Degressivity, capping and European farm structure: New evidence from Hungary", *Studies in Agricultural Economics*, Vol. 120, pp. 80-86. ISSN 1418-2106. DOI 10.7896/j.1811.
- [20] Tangermann, S. (1998) "An Ex-post Review of the 1992 MacSharry Reform", In: Ingersent, K.A., Rayner, A.J. and Hine, R.C. (eds.) "*The Reform of the Common Agricultural Policy*". Palgrave Macmillan, London. ISBN 978-1-349-26103-1. DOI 10.1007/978-1-349-26101-7_2.
- [21] World Bank Group (2018) "*Thinking CAP: Supporting agricultural jobs and incomes in the EU*", World Bank, Washington. [Online]. <https://documents.worldbank.org/en/publication/documents-reports/documentdetail/892301518703739733/eu-regular-economic-report-thinking-cap-supporting-agricultural-jobs-and-incomes-in-the-eu> [Accessed: 20 Feb. 2021].
- [22] Zhu, X. and Demeter, M. R. (2012) "Technical efficiency and productivity differentials of dairy farms in three EU countries: the role of CAP subsidies", *Agricultural Economics Review*, Vol. 13, No. 1, pp. 66-92. ISSN 1109-2580. DOI 10.22004/ag.econ.253496.
- [23] Zhu, X. and Lansink, A. O. (2010) "Impact of CAP Subsidies on Technical Efficiency of Crop Farms in Germany, the Netherlands and Sweden", *Journal of Agricultural Economics*, Vol. 61, No. 3, pp. 545-564. ISSN 0021-857X. DOI 10.1111/j.1477-9552.2010.00254.x

The Effect of Inward Foreign Direct Investment and Information and Communication Technology on Economic Growth in Indonesia

Heppi Millia¹, Pasrun Adam², Abd Azis Muthalib¹, Tajuddin¹, Yuwanda Purnamasari Pasrun³

¹ Department of Economics, Universitas Halu Oleo, Kendari, Indonesia

² Sekolah Tinggi Ilmu Ekonomi Enam Enam, Kendari, Indonesia

³ Department of Information System, Universitas Sembilanbelas November, Kolaka, Indonesia

Abstract

Inward foreign direct investment indirectly or directly affect economic growth through various means. For instance, the direct effect might be attributed to production factors, while information and communication technology changes are linked to the indirect effect. This study aimed to examine the impact of direct and indirect inward foreign investment and information and communication technology on Indonesian economic growth. The data was collected from the annual time series from 1994 to 2019. Furthermore, an autoregressive distributed lag model was used to analyze the data and provide accurate conclusions. The results showed that short-term and long-term inward foreign direct investment and information and communication technology significantly affects Indonesian economic growth. In the long term, the direct and indirect effects of inward foreign direct investment are negative and positive, respectively. However, the long-term effect of information and communication technology on economic growth is positive.

Keywords

Inward foreign direct investment, information and communication technology, economic growth, ARDL model.

Millia, H., Adam, P., Muhatlib, A. A., Tajuddin and Pasrun, Y. P. (2022) "The Effect of Inward Foreign Direct Investment and Information and Communication Technology on Economic Growth in Indonesia", *AGRIS on-line Papers in Economics and Informatics*, Vol. 14, No. 1, pp. 69-79. ISSN 1804-1930. DOI 10.7160/aol.2022.140106.

Introduction

Background and research objective

Studies show that information and communication technology (ICT) and inward foreign direct investment (IFDI) play an important role in the world economy. Developing countries, such as Indonesia, rely heavily on IFDI as an external source of state finance to improve the performance of their economies. Several developed and developing countries attract IFDI through well-drafted policies that attract these companies to operate in these countries. Host countries benefit from job creation, quality products from increased competitiveness, and the transfer of technology that can be used for future growth (Makiela and Quattara, 2018). On the other hand, ICT also plays a role in sharing, storing, and sending information between companies, investors, and consumers in a country and sometimes between countries worldwide. ICT also helps companies

to promote their products and sell them to distributors or consumers. Moreover, distributors and consumers also utilize ICT in finding quality products, buy them, make transactions online, and resell them on online platforms (Farhadi et al., 2012).

Thus far, it is clear that IFDI can directly or indirectly affect economic growth in any nation. The production factors having a direct influence on the economy include capital investment and the growth of workers. In contrast, the indirect influence includes increased worker productivity, new technologies, including ICT and knowledge (Makiela and Quattara, 2018). This concept has led economics and finance scientists to state three contradictory perspectives regarding the effect of IFDI on economic growth. The first perspective suggests that IFDI can directly or indirectly affect economic growth positively. This idea results from the neoclassical and modernization school of thought, which states that IFDI can increase

domestic capital accumulation, employ domestic workers, and enhance technology transfer, thus improving economic growth (Rahman, 2015). The second line of argument is that by worsening the current transaction on the current account and increasing foreign debt, which in turn can reduce economic growth. This perspective is from the dependency theory, which argues that IFDI can negatively affect economic growth due to an industrial monopoly structure (Dutt, 1997; Adams, 2009; Rahman, 2015).

Furthermore, foreign multinational companies often use advanced technology that can only be operated by skilled professional workers that domestic workers rarely meet the required expertise. Many foreign multinational companies investing in the country will accept only a few local workers from the host country, which may not have an expected impact on unemployment in domestic countries. An increase in the unemployment rate hurts economic growth (Moura and Forte, 2013). The third perspective explains that IFDI can positively or negatively affect economic growth depending on several factors, such as the host country's socio-political, economic, and technological conditions (Ilhan Oztuk, 2010; Edwards et al., 2016) or the period of data used (Novita and Nachrowi, 2005; Adam et al., 2015). According to the theory, a positive effect on the economy happens if the host country's economy is development-oriented; on the other hand, the negative effect will occur if the host country has a poor distribution of resources in trade (Dritsaki and Stiakakis, 2014).

ICT will impact the economy when people use it to improve their performance in production. Investors and companies often use ICT to facilitate investment, business and service activities (Kramer et al., 2007; D'souza and Joshi, 2018), reduce production costs and transaction costs (Ketteni et al., 2014). This cost reduction can increase investors' and companies' income, thus increasing national income and economic growth (Lee and Xuan, 2019; Nguen and Pam., 2020; Millia et al., 2020; Rosnawintang et al., 2021).

Several empirical studies have investigated how IFDI and ICT affect economic growth in various countries with different findings. For example, Alfaro et al. (2004) investigated the effect of IFDI on economic growth in 20 OECD countries and 51 non-OECD countries, and Anwar and Sun (2011) based their study in Malaysia with interesting results. These studies concluded that IFDI has

a positive effect on economic growth. However, these findings contradicted Alvarado et al. (2017) that investigated the effect of IFDI on the economy of Latin American countries with low income and found that IFDI had a negative impact. Interestingly, the study found that IFDI did not have a significant effect on countries with middle income. Another study by Temiz and Go'kmen (2013) in Turkey supports the later finding that IFDI does not affect economic growth.

Various researchers with interesting findings have also investigated the role of ICT on economic growth. For example, a study by Amaghionyeodiwe and Annansingh-Jamieson (2017) investigated the effect of ICT on economic growth in Caribbean countries, García (2019) in Mexico, Solomon and Klyton (2020) in African countries, Saidi et al. (2020), and Rosnawintang (2021) in Indonesia, and Arabi and Allah (2017) in Sudan. Amaghionyeodiwe and Annansingh-Jamieson (2017), García (2019), and Arabi and Allah (2017) investigated how internet users and mobile-phone users as ICT proxies affect economic growth, while Solomon and Klyton (2020), Saidi et al. (2020), and Rosnawintang (2021) examined the use of internet users as a proxy for ICT. All these studies found that ICT affects economic growth positively.

Additional studies have also examined the effect of ICT and IFDI on economic growth, including Arvin et al. (2021) that focused on G20 countries using the panel data model. The study found that ICT is affected by IFDI, which in turn affects economic growth in host countries. However, some studies examine how the interaction between ICT and IFDI affects economic growth. An excellent example of such a study is Asongu and Odhiambo (2019), conducted on 25 Sub-Saharan African countries. The study established that IFDI promotes ICT, which then affects economic growth. However, there are limited published studies on the interaction between ICT and IFDI on economic growth, and none has focused on Indonesia as a focal study. Statistically, the interaction effect in question is the indirect effect of IFDI via ICT on economic growth.

This study intends to determine the effect of IFDI, ICT, and their interaction on economic growth in Indonesia. Therefore, it can be form part of the empirical literature in economics and finance, in several areas such as (1) the direct effect of IFDI on economic growth; (2) the effect of the interaction between IFDI and ICT on economic growth, (3) the direct effect of ICT

on economic growth, and (4) the testing of these effects using an autoregressive distributed lag (ARDL) model with interaction variables. The fourth point deviates from the previous studies (Asongu and Odiambo, 2019) that used multiple regression models with interaction variables. The use of the ARDL makes it possible to examine the short and long-term effects.

Literature review

Under this subsection, the study reviews some relevant previous empirical studies to borrow their understanding. The review is divided into three groups, 1) studies focusing on the effect of IFDI on economic growth, 2) studies examining the effect of ICT on economic growth, and 3) studies explaining the interaction effect of IFDI and ICT on economic growth.

Different empirical studies conclude that IFDI has a positive or negative impact on economic growth. For instance, Aurangzeb and Stengos (2014) examined the role of IFDI on economic growth in several countries across the world using a semi-parametric smooth coefficient approach as the test tool. They found that an increase in IFDI promotes economic growth. Abdouli and Hammami (2017) conducted a study to investigate the relationship between IFDI and economic growth in MENA countries using the PVAR test of annual time series with data from 1990 to 2012. The study established that changes in IFDI cause changes in economic growth.

Additionally, Rahman (2015) conducted a study using Bangladesh's annual data from 1999 to 2013 to evaluate the effect of IFDI on economic growth in that country. Rahman employed a multiple regression model analysis, concluding that IFDI had a positive effect on economic growth. Another study by Adams (2009) used the dynamic panel model in examining the effect of IFDI on economic growth in Sub-Saharan African countries. This study collected data from 1990 to 2003, showing that IFDI positively affects economic growth. Herzer et al. (2008) also examined the effect of foreign direct investment on economic growth in 28 developing countries using the ARDL panel model to analyze the data. However, the finding of this research has divided the effects into two categories, long and short-term effect of foreign direct investment on economic growth. In the long term, foreign direct investment is found to have positive effects on some countries, while the rest is negative. Research by Susilo (2018) examined the effect of IFDI on economic growth in the United

States, dividing the economy into several sectors, such as manufacturing, real estate, wholesale trade, retail trade, finance, information, banking, insurance, and services. The finding of the results based on the multiple regression model shows that almost all sectors (manufacturing, retail, wholesale trade, real estate trade, and rentals) negatively affect economic growth.

Habibi and Zabardast (2020) focused on the effect of ICT (proxy by internet and mobile phone users) on the economy using the fixed effect panel model, with the Middle East and OECD countries as the focal of study using annual data from 2000 to 2017. The finding of this study suggested that ICT positively affects economic growth. Tripathy and Inani (2020) also investigated the ICT's effect on economic growth in South Asian Association for Regional Cooperation (SAARC) countries, including Pakistan, India, Bangladesh, and Sri Lanka. This study used a panel data model analyzing annual data from 1990 to 2014 and established that ICT proxied by internet and mobile phone users had a positive effect on the economic growth in the four countries. The study also concluded that ICT had a greater impact on India's economy than its counterparts. Another study that showed ICT's positive relationship with economic growth is Makun and Devi (2019), which focused on Fiji Islands country using the autoregressive distributed lag (ARDL) model with data from 1990 to 2016. Makun and Devi demonstrated that increased use of mobile cellular and cell phones for the internet promoted economic growth.

Dimelis and Papaioannou (2010) used annual data from 1993 to 2001 from 42 developing and developed countries and investigated the effect of IFDI and ICT on economic growth. The study's panel data model test found that IFDI positively affects economic growth in developed countries but does not affect production growth in developing countries. However, the study also established that ICT affects economic growth in all developed and developing countries. On the other hand, Ketteni et al. (2014) surveyed the effect of ICT, IFDI, and their interaction on economic growth in 15 OECD countries using annual data from 1980-2004. The test analysis used the non-parametric estimation method and concluded that IFDI, ICT, and interactions significantly impacted economic growth. Dhrifi (2015) sought to determine how IFDI and ICT on economic growth in 83 developed and developing countries by examining annual data from 1990 to 2012. The study used the number

of computer users as a proxy for ICT. A simultaneous equation model to test this effect showed that IFDI and ICT significantly affect economic growth. Some studies also ascertain that IFDI has a significant positive effect on economic growth indirectly through ICT.

Furthermore, Latif et al. (2018) explored IFDI and ICT's impact on economic growth in BRICS countries using data from 2000 to 2014. The ICT variable was proxied by the ICT index and the panel model test, concluding that IFDI and ICT affect economic growth. A U.S.-based study by Adedoyin et al. (2020) looked into the effect of IFDI, ICT, and their interaction on GDP in the country using a multiple regression model with the interaction variable and annual data from 1981 to 2017 showed that IFDI negatively affects GDP growth. It also established that ICT and interaction positively affect the GDP of the country. According to the study, the negative effect is related to the education level and the institution quality of IFDI in the United States.

Materials and methods

Data

This study uses three annual time series data types: IFDI, ICT index, and GDP per capita from 1994 to 2019. This study uses ICT index data constructed from data in internet users, mobile phone users and fixed telephone users using the weighted index method (see Latif et al., 2018 and Nair et al., 2020). In the analysis model, the variables that accommodate the natural logarithm of IFDI, ICT index, and GDP per capita data are expressed by FDI, ITI, and GDP, respectively, where GDP is a proxy for economic growth. Moreover, the interaction variable between FDI and ITI is mathematically expressed by FIT, where $FIT = FDI \times ITI$. The units of FDI are USD, ITI is expressed as a percentage (%), and GDP is the USD. ICT (internet users, mobile phone users and fixed telephone users) and GDP per capita data are obtained from the World Bank website, while IFDI data is obtained from the Indonesian Central Statistics Agency.

Methods

The study's methodology examines the long and short-term effects of IFDI, ICT, and their interactions on economic growth. The regression model is used to test the long-term cointegration between variables used with the specification

of the equation.

$$GDP_t = C + \theta FDI_t + \varphi ITI_t + \delta FIT_t + \varepsilon_t \quad (1)$$

where C , θ , φ , and δ are the long-term multiplier parameters of the regression equation (1) which are believed to be stable between 1994 and 2019. The classical assumptions of error or residual is fulfilled by ε_t in the equation (1), namely: homoscedastic, independent and normally distributed. FIT in equation (1) is the interaction variable between FDI and ITI, thus $FIT_t = FDI_t \times ITI_t$, $t = 1994, 1995, \dots, 2019$.

Equation (1) determines the modification result of the autoregressive distributed lag (ARDL) model. In the long run, the FDI, ITI, FIT, and GDP variables are considered (stable) (Heij et al., 2004). The ARDL model formulation with a time lag length of p, q, r, s abbreviated ARDL(p, q, r, s) is as follows (Pesaran et al., 1999; Heij et al., 2004).

$$GDP_t = C_0 + \sum_{i=1}^p \alpha_i GDP_{(t-i)} + \sum_{j=0}^q \theta_j FDI_{(t-j)} + \sum_{k=0}^r \varphi_k ITI_{(t-k)} + \sum_{l=0}^s \delta_l FIT_{(t-l)} + \varepsilon_{1t} \quad (2)$$

where C_0 , $\alpha_i (i = 1, 2, \dots, p)$, $\theta_j (j = 0, 1, \dots, q)$, $\varphi_k (k = 0, 1, \dots, r)$, and $\delta_l (l = 0, 1, \dots, s)$. The equation (2) also has long-term parameters, meaning that the ARDL model in (2) is also regarded as the long-term model, representing the effect of IFDI, ICT, and their interaction on economic growth in the long term (Ozturk and Acaravci, 2010). The relationship between the parameters in equations (1) and (2) is $C = \frac{C_0}{1 - \sum_{i=1}^p \alpha_i}$,

$$\theta = \frac{\sum_{j=0}^q \theta_j}{1 - \sum_{i=1}^p \alpha_i}, \quad \varphi = \frac{\sum_{k=0}^r \varphi_k}{1 - \sum_{i=1}^p \alpha_i}, \quad \text{and} \quad \delta = \frac{\sum_{l=0}^s \delta_l}{1 - \sum_{i=1}^p \alpha_i}.$$

The residual ε_{1t} is identically distributed which is independent and homoscedastic, while the parameters $\alpha_i (i = 1, 2, \dots, p)$, $\theta_j (j = 0, 1, \dots, q)$, $\varphi_k (k = 0, 1, \dots, r)$, and $\delta_l (l = 0, 1, \dots, s)$ are stable in the long term.

This study conducted four test steps to establish the relationship between IFDI, ICT, interaction, and economic growth. These four steps include 1) testing the unit root of the variables involved in the model (1) or (2); 2) testing the cointegration between FDI, ITI, FIT, and GDP variables; 3) estimating the model parameters, and 4) testing the model assumptions for residuals and parameter stability. The study employed the Augmented Dickey-Fuller (ADF) (Dickey and Fuller, 1979) and the Phillip-Perron (PP) test (Phillips

and Perron, 1988) to which are unit root tests in the first step. The hypothesis is formulated as H_0 : time series has a unit root (not stationary) versus H_1 : time series does not have a unit root (stationary). In determining whether the time series is stationary, the study used a test criterion for testing hypothesis where H_0 is rejected (H_1 is accepted) if the p-value of the test statistic is less than the critical value at a significance level of 1%, 5%, or 10%.

The second step explored the cointegration between FDI, ITI, FIT, and GDP using the theARDL bound cointegration test (Pesaran et al., 2001). The ARDL model does not allow variables that are stationary in the second difference or process I(2). This step is valuable in ensuring that none of the variables in the model in the process I(2) are non-stationary. Another requirement is that variables on the ARDL model regressors can be stationary at the first difference, level, or both. Therefore, the expected results can be represented as I(0), I(1), or both; however, the dependent variable can be represented as I(0) or I(1) (Sam et al., 2019). The ARDL bound cointegration test model formula is as follows:

$$D(GDP_t) = C_0 + \sum_{i=1}^{p-1} \alpha_i D(GDP_{(t-i)}) + \sum_{j=0}^{q-1} \theta_j D(FDI_{(t-j)}) + \sum_{k=0}^{r-1} \varphi_k D(ITI_{(t-k)}) + \sum_{l=0}^{s-1} \delta_l D(FIT_{(t-l)}) + \beta_1 GDP_{t-1} + \beta_2 FDI_{t-1} + \beta_3 ITI_{t-1} + \beta_4 FIT_{t-1} + \varepsilon_{2t} \quad (3)$$

where β_i ($i = 1, 2, 3, 4$) is the parameters of the regression equation (3) and ε_{2t} is the residual. The ARDL bound cointegration test hypothesis formulation between FDI, ITI, FIT and GDP is H_0 : $\beta_1 = \beta_2 = \beta_3 = \beta_4 = 0$ signifying that all-time series are not cointegrated. On the other hand, the alternative hypothesis is H_1 : is $\beta_j \neq 0, j = 1, 2, 3, 4$ signifying that all-time series are cointegrated. If the F-statistic value is greater than the critical value

of the upper bound I(1) at a significance level of 1%, 5%, or 10% , then the H_0 is rejected and (H_1 is accepted).

The third step of the study examines the short-term effect of IFDI, ICT, and their interaction on economic growth using the error correction model (ECM-ARDL). The formula for the ECM-ARDL(p-1, q-1, r-1, s-1) model is as follows (Heij et al., 2004).

$$D(GDP_t) = \theta_0 D(FDI_t) + \varphi_0 D(ITI_t) + \delta_0 D(FIT_t) + \pi EC_{t-1} + \sum_{i=1}^{p-1} \alpha_i^* D(GDP_{(t-i)}) + \sum_{j=1}^{q-1} \theta_j^* D(FDI_{(t-j)}) + \sum_{k=1}^{r-1} \varphi_k^* D(ITI_{(t-k)}) + \sum_{l=1}^{s-1} \delta_l^* D(FIT_{(t-l)}) + \varepsilon_{2t} \quad (4)$$

where in equation (4), α_i^* ($i = 1, 2, \dots, p - 1$), θ_j^* ($j = 1, 2, \dots, q - 1$), φ_k^* ($k = 1, 2, \dots, r - 1$) and δ_k^* ($k = 1, 2, \dots, s - 1$) are short-term parameters.

The fourth step of the analysis tests the stability of the classical assumptions of residuals and model parameters. The Breusch-Pagan-Godfrey (BPG), Breusch-Godfrey Serial Correlation LM (BGSCLM), and Jarque Bera (JB) tests were also used in testing homoscedasticity, independence, and normality of the parameters. However, testing the stability of the model parameters required the use of the CUSUM and CUSUM Square tests (Brown et al., 1975).

Results and discussion

Results

Table 1 shows the statistical values of the stationarity testing of all variables. The results of ADF and PP tests indicate that FDI and FIT are stationary in the second difference, while ITI and GDP are stationary at the level and first difference.

Variable	ADF test statistics		PP test statistics	
	Intercept	Intercept and trend	Intercept	Intercept and trend
FDI	-1.2572	-2.7615	-1.1331	-2.7118
D(FDI)	-5.6727*	-5.5613*	-6.1198*	-6.0643*
ITI	-3.6916**	1.2725	-2.9567***	1.0594
D(ITI)	-1.0408	-3.6468**	-2.5137	-3.6237**
FIT	-0.8372	-2.159	-0.7767	-2.1622
D(FIT)	-5.2916*	-5.1663*	-5.3117*	-5.1803*
GDP	1.3584	-24.6660*	0.6207	-1.5709
D(GDP)	-2.7097***	-4.1125**	-3.7397**	-4.1525**

Note: *, **, *** significant 1%, 5%, 10%
Source: Own processing

Table 1: Stationary test results.

After testing, the next step is to test the cointegration between FDI, ITI, FIT, and GDP with the ARDL bound test follows the testing for stationarity of all variables used in the research. Before the cointegration test, a determination of the length of the lag time of the ARDL model is first conducted based on the minimum statistic value of the AIC (Akaike Information Criteria), thus obtaining the time lag lengths as $p = 1$, $q = 3$ and $r = s = 4$. This means that the ARDL(1,3,4,4) bound model is used to test cointegration. According to the calculation from the data, the F-test statistic value is 177.8733, which is compared with the critical statistic of upper bound I(1) at a significance level of 1% of 4.66. Since the critical statistic is much smaller than the test statistic, it is concluded that there is long-term cointegration between FDI, ITI, FIT, and GDP.

Table 2 below contains statistic values that can help in estimating the long and short-term parameters and coefficients. The table shows that the long-term coefficients of FDI, ITI, and FIT are significant at the significance level of 7%, 1%, and 5%, respectively, meaning they affect economic growth in the long term. The result also shows that IFDI harms the economy, meaning that economic growth will decrease if it increases. However, the indirect effect of IFDI through ICT on economic

growth is positive, showing that in the long term, an increase in IFDI contributes to an increase in ICT, which in turn increases economic growth. On ICT, the results show a positive long-term effect on economic growth-. Increase in ICT promotes increased economic growth.

Table 2 in panel B also shows the estimation results for the short-term parameters of the ECM-ARDL model. All the coefficients of the variables in the ECM-ARDL(0,2,3,3) model are significant, except for D(ITI (-1)) and D(ITI(-3)). This table highlights that, in the short term, there are direct and indirect effects of IFDI and ICT on economic growth.

Table 2 also shows the calculation results of Chi-square statistic probability values from the autocorrelation (BGSCLM), homoscedasticity (BPG), and normality (JB) tests on the residuals. The ARDL(1,3,4,4) model has independent, homoscedastic, and normally distributed residuals. Furthermore, the stability of the ARDL(1,3,4,4) model parameters is also tested. The CUSUM and CUSUM Square tests show that the model parameters are stable. The stability test results are shown in Figure 1.

Intercept and variable independent	Coefficient	t-Statistics	P-value
A. Long-run coefficient, dependent variable: GDP			
FDI	-0.1667	-2.2821	0.0626
ITI	0.1141	11.234	0.0000
FIT	0.0250	3.4872	0.0130
C	7.7294	235.4484	0.0000
B. Short-run coefficient, Dependent variable: D(GDP)			
D(FDI)	0.0739	8.4423	0.0002
D(FDI(-1))	0.1562	10.4338	0.0000
D(FDI(-2))	0.1324	8.2427	0.0002
D(ITI)	0.0271	4.1334	0.0061
D(ITI(-1))	-0.0011	-0.2357	0.8215
D(ITI(-2))	0.0260	5.9585	0.0010
D(ITI(-3))	0.0040	1.3719	0.2192
D(FIT)	-0.0080	-6.8476	0.0005
D(FIT(-1))	-0.0199	-10.5522	0.0000
D(FIT(-2))	-0.0166	-8.3887	0.0002
D(FIT(-3))	0.0009	2.3080	0.0604
EC(-1)	-0.5430	-38.5004	0.0000

Note: The p-values of the test statistics based on the Chi-Square statistics of BPG, BGSCLM, and JB are 0.8130, 0.7651, and 0.377583, respectively.

Source: Own processing

Table 2: Estimation of long and short-term coefficients from ARDL(1,3,4,4) and ECM-ARDL(0,2,3,3) models.

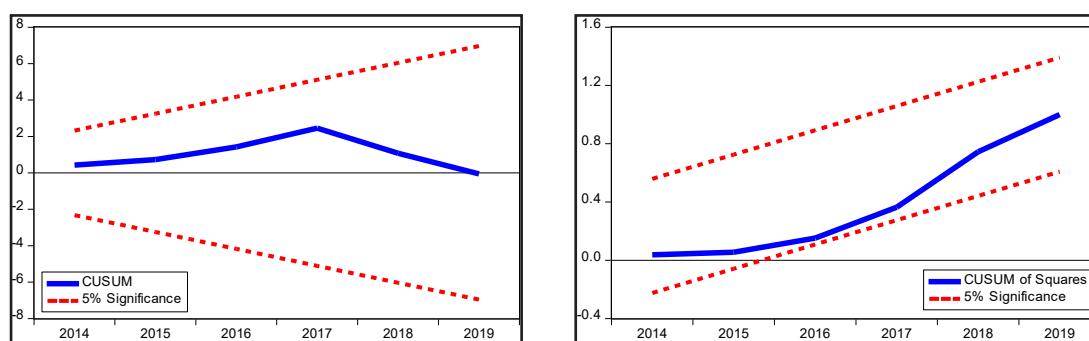

Source: Own processing.

Figure 1: CUSUM and CUSUM Square tests.

Discussion

IFDI has direct and indirect effects on economic growth in the long term. Several studies, such as Susilo (2018), Latif et al. (2018), Alafarado et al. (2017), Herzer et al. (2008), and Adedoyin et al. (2020), show that IFDI has a negative direct effect on economic growth. This is attributed to various factors, including the emergence of industrial monopolies practiced by multinational companies (Dutt, 1997; Adams, 2009; Rahman, 2015); the level of education and quality of IFDI inflow institutions (Adedoyin et al., 2020), and the low absorption of local workers by multinational companies in the host country (Moura and Forte, 2013); However, other studies, such as Dimelis and Papaioannou (2010), Aurangzeb and Stengos (2014), Abdouli and Hammami (2016), Rahman (2015), and Adams (2009) arrived at a different conclusion. This difference could be due to the differences in the characteristics of the countries used as study locations (Ozturk, 2010; Edwards et al., 2016) or the period of data used (Novita and Nachrowi, 2005; Adam et al., 2015). This is in line with Ketteni et al. (2014), Dhrifi (2015), and Adedoyin et al. (2020), which showed that this aspect positively impacting the economy. Some studies also show that IFDI can affect economic growth in the short term, as supported by Herzer et al. (2008).

ICT positively affects economic growth in the long term. Adopting technology in economic activity may increase economic growth. This is in line with Makun and Devi (2019), Habibi and Zabardast (2020), and Tripathy and Inani (2020). The proposed policy implies that IFDI is an integral part of the economy and should be promoted for economic growth.

Various stakeholder policies, including restricting industrial monopolies for multinational companies and increasing the absorption of local workers

to work in multinational companies, should prioritize making IFDI a driving factor for economic growth. The increase in worker absorption can reduce the unemployment rate, promoting economic growth, especially in Indonesia as one of the IFDI recipient countries. Although the empirical results show that ICT drives economic growth, there is room to grow in many developing countries as the world becomes digitalized. The results of this development will significantly contribute to the advancement of ICT in all fields, especially in economics and finance. The impact of ICT development relates to its use in the economy, such as minimizing industrial costs, which can increase national income and economic growth.

Conclusion

IFDI and ICT affect the world economy, including Indonesia. Studies on IFDI on economic growth show that it can directly or indirectly affect the economy. The direct effect relates to the use of capital and workers, while the indirect effect is attributed to ICT advancement. Specifically, ICT improves economic performance because companies rely on it to promote their e-commerce. Consumers also utilize it to determine quality products, buy them, and make online transactions. This study examined the direct and indirect effects of IFDI and ICT on economic growth using annual time series data from 1994 to 2019. IFDI, ICT index, and GDP per capita data were used as proxies for economic growth while data was analyzed through ARDL model.

The test using the ARDL model found long-term cointegration between IFDI, ICT, and their interactions with economic growth. The estimation results of ARDL(1,3,4,4) and ECM-ARDL(0,2,3,3) model parameters showed that the IFDI and ICT have long and short-term effects on the growth economy.

Corresponding authors

Heppi Millia

Department of Economics, Faculty of Economics and Business

Universitas Halu Oleo, Kendari 93232, Indonesia

E-mail: hepimilias3@gmail.com

References

- [1] Abdouli, M. and Hammami, S. (2017) "Investigating the causality links between environmental quality, foreign direct investment and economic growth in MENA countries", *International Business Review*, Vol. 26, No. 2, pp. 264-278. ISSN 0969-5931. DOI 10.1016/j.ibusrev.2016.07.004.
- [2] Adam, P, Rianse, U, Cahyono, E. and Rahim, M. (2015) "Modeling of the dynamics relationship between world crude oil prices and the stock market in Indonesia", *International Journal of Energy Economics and Policy*, Vol. 5, No. 2, pp. 550-557. ISSN 2146-4553.
- [3] Adam, S. (2009) "Foreign Direct investment, domestic investment, and economic growth in Sub-Saharan Africa", *Journal of Policy Modeling*, Vol. 31, pp. 939-949. ISSN 0161-8938. DOI 10.1016/j.jpolmod.2009.03.003.
- [4] Adedoyin, F. F., Bekun, F. V., Driha, O. M. and Balsalobre-Lorente, D. (2020) "The effects of air transportation, energy, ICT and FDI on economic growth in the industry 4.0 era: Evidence from the United States", *Technological Forecasting & Social Change*, Vol. 60, 120297. ISSN 0161-8938. DOI 10.1016/j.techfore.2020.120297.
- [5] Alfaro, L., Chanda, A., Kalemli-Ozcan, S. and Sayek, S. (2004) "FDI and economic growth: The role of local financial markets", *Journal of International Economics*, Vol. 64, No. 1, pp. 89-112. ISSN 0022-1996. DOI 10.1016/S0022-1996(03)00081-3.
- [6] Alvarado, R., Iñiguez, M. and Ponce, P. (2017) "Foreign direct investment and economic growth in Latin America", *Economic Analysis and Policy*, Vol. 56, pp. 176-187. ISSN 0313-5926. DOI 10.1016/j.eap.2017.09.006.
- [7] Amaghionyeodiwe, L. and Annansingh-Jamieson, F. (2017) "An investigation into the impact of mobile technologies on economic growth and employment in the Caribbean", *Athens Journal of Business & Economics*, Vol. 3, No. 3, pp. 263-278. ISSN 2241-794X. DOI 10.30958/ajbe.3.3.3.
- [8] Anwar, S. and Sun, S. (2011) "Financial development, foreign investment and economic growth in Malaysia", *Journal of Asian Economics*, Vol. 22, pp. 335-342. ISSN 1049-0078. DOI 10.1016/j.asieco.2011.04.001.
- [9] Arabi, A. M. K. and Allah, B. A. W. (2017) "The impact of information and communication technology (ICT) development on economic growth in Sudan: An application of ARDL bounds testing approach", *Archives of Business Research*, Vol. 5, No. 3, pp. 155-164. ISSN 2054-7404. DOI 10.14738/abr.53.2886.
- [10] Arvin, M. B., Pradhan, R. P. and Nair, M. (2021) "Uncovering interlinks among ICT connectivity and penetration, trade openness, foreign direct investment, and economic growth: The case of the G-20 countries", *Telematics and Informatics*, Vol. 60. ISSN 0736-5853. DOI 10.1016/j.tele.2021.101567.
- [11] Asongu, S. A. and Odhiambo, N. M. (2019) "Foreign direct investment, information technology and economic growth dynamics in Sub-Saharan Africa", *Telecommunications Policy*, Vol. 44, No. 1. ISSN 0308-5961. DOI 10.2139/ssrn.3417047.
- [12] Aurangzeb, Z. and Stengos, T. (2014) "The role of Foreign Direct Investment (FDI) in a dualistic growth framework: A smooth coefficient semi-parametric approach", *Borsa Istanbul Review*, Vol. 14, No. 3, pp. 133-144. ISSN 2214-8450. DOI 10.1016/j.bir.2014.06.004.
- [13] Brown, R. L., Durbin, J. and Evans, J. M. (1975) "Techniques for Testing the Consistency of Regression Relations Over Time", *Journal of the Royal Statistical Society. Series B (Methodological)*, Vol. 37, No. 2, pp. 149-192. ISSN 1369-7412. DOI 10.1111/j.2517-6161.1975.tb01532.x.

- [14] Dhrifi, A. (2015) "Foreign direct investment, technological innovation and economic growth: empirical evidence using simultaneous equations model", *International Review of Economics*, Vol. 62, pp. 381-400. ISSN 18634613. DOI 10.1007/s12232-015-0230-3.
- [15] Dickey, D. A. and Fuller, W. A. (1979) "Distribution of the estimators for autoregressive time series with a unit root", *Journal of the American statistical Association*, Vol. 74, pp. 427-443. ISSN 0162-1459 DOI 10.2307/2286348.
- [16] Dimelis, S. P. and Papaioannou, S. K. (2010) "FDI and ICT effects on productivity growth: A comparative analysis of developing and developed countries", *European Journal of Development Research*, Vol. 22, No. 1, pp. 79-96. ISSN 0162-1459. DOI 10.1057/ejdr.2009.45.
- [17] Dritsaki, C. and Stikakis, E. (2014) "Foreign direct investments, exports, and economic growth in Croatia: A time series analysis", *Procedia Economics and Finance*, Vol. 14, pp. 181-190. ISSN 2212-5671. DOI 10.1016/S2212-5671(14)00701-1.
- [18] D'souza, D. J. and Joshi, H. G. (2018) "ICT Intervention in the Socio-Economic Development of Udupi Jasmine", *AGRIS on-line Papers in Economics and Informatics*, Vol. 10, No. 4, pp. 17-25. ISSN 1804-1930. DOI 10.7160/aol.2018.100402.
- [19] Dutt, A. K. (1997) "The pattern of direct foreign investment and economic growth", *World Development*, Vol. 25, No. 11, pp. 1925-1936. ISSN 0305-750X. DOI 10.1016/S0305-750X(97)00081-8.
- [20] Edward, J. A., Romero, A. A. and Madjd-Sadjadi, Z. (2016) "Foreign direct investment, economic growth, and volatility: a useful model for policymakers", *Empirical Economics*, Vol. 51, pp. 681-705. ISSN 03777332. DOI 10.1007/s00181-015-1022-z.
- [21] Farhadi, M., Ismail, R. and Fooladi, M. (2012) "Information and communication technology use and economic growth", *PLoS ONE*, Vol. 17, No. 11, pp. 1-7. ISSN 19326203. DOI 10.1371/journal.pone.0048903.
- [22] García, M. J. (2019) "The impact of information and communication technologies on economic growth in Mexico", *International Journal of Business and Social Research*, Vol. 9, No. 2, pp. 11-22. ISSN 2164-2540.
- [23] Habibi, F. and Zabardast, M. A. (2020) "Digitalization, education and economic growth: A comparative analysis of Middle East and OECD countries", *Technology in Society*, Vol. 63. ISSN 0160-791X. DOI 10.1016/j.techsoc.2020.101370.
- [24] Heij, C., De-Boer, P., Franses, P. H., Kloek, T. and Van-Dijk, H. K. (2004) "Econometric method with applications in business and economics", New York: Oxford University Press. ISBN-13 978-0199268016.
- [25] Herzer, D., Klasen, S. and Nowak-Lehmann, F. (2008) "In search of FDI-led growth in developing countries: The way forward", *Economic Modelling*, Vol. 25, No. 5, pp. 793-810. ISSN 0264-9993. DOI 10.1016/j.econmod.2007.11.005.
- [26] Ketteni, E., Kottaridi, C. and Mamunea, T. P. (2014) "Information and communication technology and foreign direct investment: interactions and contributions to economic growth", *Empirical Economics*, Vol. 48, pp. 1525-1539. ISSN 0264-9993. DOI 10.1007/s00181-014-0839-1.
- [27] Kramer, W. J., Jerkins, B. and Katz, R. S. (2007) "The Role of the Information and Communications Technology Sector in Expanding Economic Opportunity (Rep. No. 22)", Cambridge, Massachusetts: Harvard Kennedy School. [Online]. Available: https://sites.hks.harvard.edu/m-rcbg/CSRI/publications/report_22_EO%20ICT%20Final.pdf [Accessed: 15 April 2018].
- [28] Latif, Z., Mengke, Y., Danish., Ximei, L., Pathan, Z. H., Salam, S. and Jianqiu, Z. (2018) "The dynamics of ICT, foreign direct investment, globalization and economic growth: Panel estimation robust to heterogeneity and cross-sectional dependence", *Telematics and Informatics*, Vol. 35, No. 2, pp. 318-328. ISSN 0736-5853. DOI 10.1016/j.tele.2017.12.006.

- [29] Lee, J. W. and Xuan, Y. (2019) "Effects of technology and innovation management and total factor productivity on the economic growth of China", *Journal of Asian Finance, Economics and Business*, Vol. 6, No. 2, pp. 63-73. ISSN 2288-4637. DOI 10.13106/jafeb.2019.vol6.no2.63.
- [30] Makiela, M. and Quattara, B. (2018) "Foreign direct investment and economic growth: Exploring the transmission channels", *Economic Modelling*, Vol. 72, pp. 296-305. ISSN 02649993. DOI 10.1016/j.econmod.2018.02.007.
- [31] Makun, K. and Devi, S. (2019) "The effect of information and Communication technology on economic output: An empirical study of the Republic of Fiji Islands", *International Journal of Development Issues*, Vol. 18, No. 2, pp. 229-242. ISSN 14468956. DOI 10.1108/IJDI-09-2018-0137.
- [32] Millia, H., Adam, P., Saenong, Z., Balaka, M. Y., Pasrun, Y. P., Saidi, L. O. and Rumbia, W. A. (2020) "The influence of crude oil prices volatility, the internet and exchange rate on the number of foreign tourist arrivals in Indonesia", *International Journal of Energy Economics and Policy*, Vol. 10, No. 6, pp. 280-287. ISSN 2146-4553. DOI 10.32479/ijeep.10083.
- [33] Moura, R. and Forte, R. (2013) "The effects of foreign direct investment on the host country economic growth - theory and empirical evidence", *Singapore Economic Review*, Vol. 58, No. 3. ISSN 0217-5908. DOI 10.1142/S0217590813500173.
- [34] Nair, M., Pradhan, R. P. and Arvin. M. B. (2020) "Endogenous dynamics between R&D, ICT and economic growth: Empirical evidence from the OECD countries", *Technology in Society*, Vol. 62. ISSN 0160-791X. DOI 10.1016/j.techsoc.2020.101315.
- [35] Nguen, L. P. and Pham, V. H. T. (2020) "Trade of ICT products, government, and economic growth: Evidence from East Asia-Pacific Region", *Journal of Asian Finance, Economics and Business*, Vol. 7, No. 8, pp. 175-183. ISSN 22884637. DOI 10.13106/jafeb.2020.vol7.no8.175.
- [36] Novita, M. and Nachrowi, N. D. (2005) "Dynamic analysis of stock price index and exchange rate using vector autoregression (VAR) empirical study in JSX 2001-2004", *Economic and Finance in Indonesia*, Vol. 53, No. 3, pp. 263-278. ISSN 0125-155X.
- [37] Ozturk, I. and Acaravci, A. (2010) "The causal relationship between energy consumption and GDP in Albania, Bulgaria, Hungary and Romania: Evidence from ARDL bound testing approach", *Applied Energy*, Vol. 87, No. 6, pp. 1938-1943. ISSN 0306-2619. DOI 10.1016/j.apenergy.2009.10.010.
- [38] Pesaran, M. H. and Shin, Y. (1999) "An autoregressive distributed-lag modeling approach to cointegration analysis", In S. Strom (eds) *Econometrics and Economic Theory in the 20th Century*, The Ragnar Frisch Centennial Symposium (pp. 371-413). Cambridge: Cambridge University Press. ISBN-13 978-0521633239. DOI 10.1017/CCOL521633230.011.
- [39] Pesaran, M. H., Shin, Y. and Smith, R. J. (2001) "Bounds testing approaches to the analysis of level relationships", *Journal of Applied Econometrics*, Vol. 162, No. 3, pp. 89-326. ISSN 0883-7252. DOI 10.1002/jae.616.
- [40] Phillips, P. C. B. and Perron, P. (1998) "Testing for a unit root in time series regression", *Biometrika*, Vol. 75, No. 2, pp. 335-346. ISSN 0006-3444. DOI 10.1093/biomet/75.2.335.
- [41] Rahman, A. (2015) "Impact of foreign direct investment on economic growth: Empirical evidence from Bangladesh", *International Journal of Economics and Finance*, Vol. 7, No. 2, pp. 178-185. ISSN 1916-971X. DOI 10.5539/ijef.v7n2p178.
- [42] Rosnawintang, R., Tajuddin, T., Adam, P., Pasrun, Y. P. and Saidi, L. O. (2021) "Effects of crude oil prices volatility, the internet and inflation on economic growth in ASEAN-5 countries: A panel autoregressive distributed lag approach", *International Journal of Energy Economics and Policy*, Vol. 11, No. 1, pp. 15-21. ISSN 21464553. DOI 10.32479/ijeep.10395.
- [43] Saidi, L. O., Millia, H., Adam, P., Pasrun, Y. P. and Arsad Sani, L. O. (2020) "Effect of internet, money supply and volatility on economic growth in Indonesia", *International Journal of Advanced Science and Technology*, Vol. 29, No. 3, pp. 5299 - 5310. ISSN 2005-4238.

- [44] Sam, C. Y., McNown, R. and Goh, S. K. (2019) "An augmented autoregressive distributed lag bounds test for cointegration", *Economic Modelling*, Vol. 80, pp. 130-141. ISSN 02649993. DOI 10.1016/j.econmod.2018.11.001.
- [45] Solomon, E. M. and Klyton, A. (2020) "The impact of digital technology usage on economic growth in Africa", *Utilities Policy*, Vol. 67. ISSN 0957-1787. DOI 10.1016/j.jup.2020.101104.
- [46] Susilo, D. (2018) "The impact of foreign direct investment on economic growth (a causal study in the United States)", *BISE: Jurnal Pendidikan Bisnis dan Ekonomi*, Vol. 4, No. 1, pp. 50-63. ISSN 2579-728X. DOI 10.20961/bise.v4i1.21422.
- [47] Temiz, D. and Gökmen, A. (2013/2014) "FDI inflow as an international business operation by MNCs and economic growth: An empirical study on Turkey", *International Business Review*, Vol. 23, No. 1, pp. 145-154.. ISSN 0969-5931. DOI 10.1016/j.ibusrev.2013.03.003.
- [48] Tripathi, M. and Inani, S. K. (2020) "Does information and communications technology affect economic growth? Empirical evidence from SAARC countries", *Information Technology for Development*, Vol. 26, No. 4, pp. 1-15. ISSN 0268-1102. DOI 10.1080/02681102.2020.1785827.

The Role of Banks in Financing the Slovak Agricultural Sector

Adriana Novotná, Kristína Kočíšová

Department of Banking and Investment, Faculty of Economics, Technical University of Košice, Slovak Republic

Abstract

A well-developed financial system plays an important role in financing individual sectors in the country. In this paper, we analyse credit development in the agricultural sector in the Slovak Republic from various perspectives. We examine the relationship between the agricultural sector's characteristics and the volume of funding at the regional level. The paper's methodology is based on a k-means algorithm for clustering the Slovak regions with four criteria. Then we examine the relationship between financial development and agricultural growth by employing the Cobb-Douglas production function. This study uses annual data covering the period from 2008 to 2019. The results reveal that financial development has a significant and positive effect on agricultural production and agricultural growth.

Keywords

Slovak agricultural sector, financial development, agriculture growth, cluster analysis, data analysis.

Novotná, A. and Kočíšová, K. (2022) "The Role of Banks in Financing the Slovak Agricultural Sector", *AGRIS on-line Papers in Economics and Informatics*, Vol. 14, No. 1, pp. 81-94. ISSN 1804-1930. DOI 10.7160/aol.2022.140107.

Introduction

One of the conditions for the successful functioning of individual sectors of the national economy is a well-functioning financial system. A financial system could be defined as the sum of financial and non-financial entities that meet in the market in which they carry out financial transactions using financial instruments. The basic task of the financial system is to ensure financial intermediation, i.e. the transfer of funds from surplus to deficit entities. This transfer of funds between surplus and deficit entities can take place in two basic ways, either directly or indirectly, depending on which we are talking about direct or indirect financing. In direct financing, the transfer of funds is made directly on the financial market, with no intermediary entering into the relationship between the creditor and the debtor. For example, market deficit may offer debt security (bonds), which surplus entities may purchase. In this way, the deficit entities will receive funds, while surplus entities invest their free funds with a future return prospect. The second is indirect financing, which is channelled through financial intermediaries specialising in raising funds from surplus entities and providing them effectively to deficit entities. In this case, there is no direct connection between

the creditor and the debtor, but into the relationship between them, the financial intermediary is entered. In European countries, the indirect financing method prevails, where commercial banks are the leading financial intermediary. Commercial banks most often raise funds in deposits from depositors and invest them in loans offered to different economic entities, whether households, non-financial corporations or other entities. The benefits of this method are transferring the potential risk to the financial intermediary and eliminating time and volume mismatches.

Commercial banks offer solution for financing individual sectors. As one of the national economy sectors, the agricultural sector has a specific role in the process of economic development of a country. As stated by the European Environment Agency (2020), the agricultural sector is one of the primary land users in Europe and thus shapes landscapes in rural areas. Two of the main challenges confronting agriculture in Europe are climate change (European Environment Agency, 2017a) and land take, i.e. the conversion of land to settlements or infrastructure (European Environment Agency, 2017b). The importance of agriculture is higher in less industrialised countries, but this does not mean that in economically developed countries, its importance

is lower. It has various direct and indirect effects on the environment, and it is dependent on natural resources, which also maintain, whereas the other sectors of the national economy only use them. In October 2018, Food and Agriculture Organization of the United Nations (2018) highlighted information that total commercial credit disbursed by commercial banks to the agricultural sector increased from 2.4% in 2016 to 2.9% in 2017. However, this appears that agricultural producers face a negative bias in access to credit due to the agriculture sector globally contributed over 4% of gross domestic product (GDP).

The role of bank credit to the agricultural sector is crucial in the southern countries, Africa and the southern region of Asia, where the population is widely involved in agriculture. One of the recent studies, by Oyelade (2019), investigates the effect of commercial bank credit on agricultural output and subsector of agriculture in Nigeria. The author explains the importance of the bank lending channel in the nation for a better performance of both the subsector of agriculture and the sector as a whole, as the monitored banking indicators are statistically significant in determining agricultural output in Nigeria. Results of the study are supported by the study by Obilor (2013). Another Nigerian study by Ammani (2012) observed that bank credit is positively and significantly related to the productivity of crops, livestock and fishing sectors. Chisasa (2014) finds a positive and significant relationship between bank credit and agricultural production in South Africa using the Cobb-Douglas function. Agbodji and Johnson (2019) show that the agriculture productivity of small farmers in Togo, who have access to credit, is higher than those who do not access it. In Pakistan, where the agriculture sector plays a major role in the economy, the analysis used by Shahbaz et al. (2013) reveals bidirectional causality between agricultural growth and financial development, with credit classification into long, medium and short terms. The importance of bank credit to agriculture in India reveals studies by Mohan (2006), Das et al. (2009), or publication by Ramakumar and Chavan (2014), which analyses an increase in the number of rural bank branches and the growth of agricultural credit in Indian in the early 2000s. Overall, we can summarise the previous results into the following points. Toby and Peterside (2014) identify a significantly positive correlation between merchant bank lending to agriculture and agricultural GDP. In the opinion of Narayanan (2015), credit can

contribute to the growth of agricultural GDP through the purchase of variable inputs. He argues that a 10% increase in credit flow in nominal terms leads to an increase by 1.7% in fertilisers consumption, 5.1% increase in the tonnes of pesticides, 10.8% increase in tractor purchases. Shahbaz et al. (2013) suggest that the government should give the rural population access to financial resources at a cheaper rate to improve the contribution of the agriculture sector in the overall economic growth. A study by Khan et al. (2017) proved that agricultural credit leads to agricultural growth, bringing prosperity for the farms. Hussain et al. (2015) conclude that agriculture credit gradually increased over the past years, and they argue that institutional credit has a significant impact on agricultural productivity.

In the literature, we can also find studies that examine agricultural productivity and analyse its changes in European countries through the decomposition of Total factor productivity (TFP). As Kijek et al. (2019) mention, productivity in agriculture can be measured as partial productivity, referring to a single factor or a total productivity (multi-factor). TFP of agriculture has been investigated extensively for a selected group of states or a selected period. For example, Baráth and Fertő (2017) use country-level data for 23 European Union (EU) countries and find out slightly decrease in agricultural productivity in the EU over the analysed period from 2004 to 2013; however, there were significant differences between old and new member states. Also, Čechura et al. (2014) analyse Total factor productivity in EU countries and they observe a positive trend in agricultural productivity in most EU countries. This methodology could also be seen in the study of Nowak et al. (2016), Laborde and Piñeiro (2018), and others.

The agricultural sector is one of the sectors with a significant share in the volume of loans in several European countries. This is also proven by the data published by the European Banking Authority (Figure 1). Based on these data, we can divide European countries into countries where the agricultural sector is largely financed by bank loans and countries where this share is lower. The countries with the highest share of loans to the agriculture of the 02Q/2020 include the Netherlands (13.9%), Luxembourg (13.8%), Iceland (13.3%), and Latvia (12.1%). On the other hand, Malta (0.1%) and Germany (0.6%) are among the countries with the lowest share of loans to agriculture. On average, in the European Union countries, the share

of loans to agriculture is 3.8%. Slovakia (4.1%), together with nine countries, is in the interval with the highest frequency. Besides Slovakia, we can also see Finland (5.4%), Ireland (5.1%), Croatia (4.9%), Norway (4.5%), Belgium (4%), the Czech Republic (3.9%), France (3.7%), Portugal (3.6%), and Lithuania (3.5%).

A study by Rogach et al. (2019) has pointed out that agriculture is one of the most important industrial branches of the European Union. There are developed several banking systems in the countries with an important role in agriculture, e.g. "Crédit Agricole" in France, "Rabobank" in the Netherlands, "the Union of German People's Banks" and "Raiffeisen Societies" in Germany, etc. As Koester (2016) stated, the development of the agricultural sector is strongly influenced by the European Union's Common Agricultural Policy. Currently, it features two main pillars: Pillar 1, under which direct payments to farmers and market interventions are covered, and Pillar 2, under which rural development programmes are supported. Even though the impact of agricultural finance is important, there is a lack of publications in Europe about this topic, comparing to Asia and Africa. Therefore there is a necessity of the research. One of the first studies focusing on most European countries is presented by Shan and Morris (2002), who examine causality tests for nineteen OECD countries. According to the results, they argue that in most instances, financial development occurs simultaneously with economic growth. Later, Fecke et al. (2016) examine the determinants of loan demand

in agriculture in Germany and bring some practical implications for banks in the agricultural sector in developed countries. Juszcyk (2018) finds out that loans for agriculture are not determining to generate the net profit of banks in Poland. Varraso and Dimitrio (2020) analyse bank loans to agriculture in Italy and Apulia during the last global economic crisis.

The relationship between Slovak agriculture and bank lending has been analysed in a study by Rabek (2006), who focuses on the development of long-term and short-term bank credits between the 2000 and 2005 period. Kalusova and Badura (2017) examine the indebtedness rate of the selected Czech and Slovak agricultural enterprises by regression analysis, with a strong positive correlation in the long-term indebtedness. The observed enterprises use bank loans as a source of financing, but the authors argue that, in general, it is not a common way of financing agricultural enterprises in these countries. Toth et al. (2020) provide an analysis of loans in Slovak agriculture of four main banks providing loans to farmers in Slovakia. Authors arguing that banks provide working capital to farms in the amount of annual farm's direct payments, and they comment there is a lack of appropriate financial products for small and young farmers (less than 40 years, farms smaller than 100 ha).

In the economy, the agriculture sector supports the diversification of economic activities in rural areas. It is an important factor in maintaining the workforce by generating job opportunities,

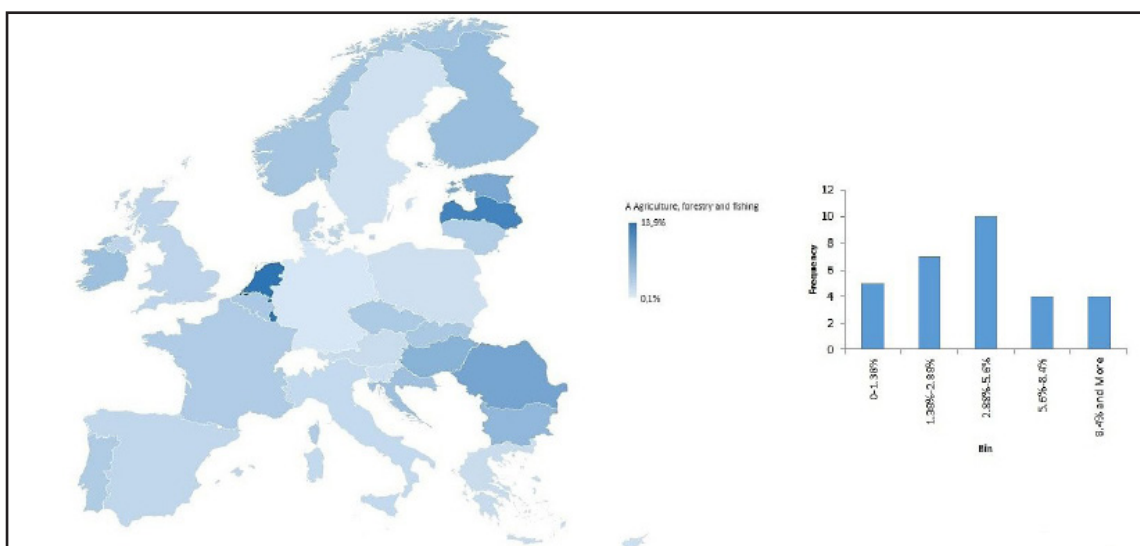

Source: Prepared by authors

Figure 1: Distribution of non-financial corporation loans advanced in Agriculture, forestry and fishing (percentage of total loans, Q2/2020).

thus contributing to the reduction of regional disparities. Therefore, it is important to focus on monitoring the financial situation, evaluate lending in agriculture as well as deposits in the agricultural sector. Skriniarova and Bandlerova (2012) state that the agricultural sector is one of the least capitalised sectors of the economy. This means that it needs sufficient credit resources to ensure continuous agricultural production. This paper aims to analyse the development of credit in the agricultural sector in Slovakia from various perspectives, as well as to examine the relationship between the characteristics of the agricultural sector and the volume of funding at the regional level, in order to determine whether the development of the financial market can be considered as an important factor in the development of agriculture in the Slovak regions during the period from 2008 to 2019.

Materials and methods

The methodological approach taken in this paper is a mixed methodology based on a k-means algorithm for clustering and examining the impact of financial development on agricultural growth by employing the Cobb-Douglas production function, which was previously used in several studies, e.g. Čechura (2006), Shahbaz et al. (2013), Ekwere and Edem (2014), Andersson et al. (2016) or Shabir et al. (2020).

Firstly, the k-means algorithm is used for clustering Slovak regions. We make clusters according to different criteria. Yaya et al. (2020) mentioned that the k-means cluster algorithm is a commonly used methodology due to its design simplicity, theoretical reliability, and excellent extendibility. This method uses distance as the evaluation index of similarity, divides the sample into clusters, which means the distance is negatively correlated with the similarity. Sample similarity differs significantly among clusters.

Before the application of cluster analysis, the data must be standardised to make variables comparable. In literature, we can find two types of standardisation: empirical and statistical standardisation. In our study, empirical standardisation is used, which normalise values compared to minimum and maximum within the sample. The reason is that our variables are in different units and have different variation, as could be seen in the results section (Table 1).

$$I_{it}^n = \frac{I_{it} - \text{Min}(I_i)}{\text{Max}(I_i) - \text{Min}(I_i)} \quad (1)$$

The classification of observations into groups requires specific methods to calculate the distance between each pair of observations. As Kaufman and Rousseeuw (1990) presented, the classical methods for distance measures are Euclidean and Manhattan distance. In our paper, we apply the Euclidean distance method, which is defined as follow:

$$d_{\text{euc}}(x, y) = \sqrt{\sum_i^n (x_i - y_i)^2} \quad (2)$$

where x and y are vectors of length n .

K-means clustering is the most commonly used algorithm for partitioning a given data set into a set of k groups (k clusters), where k represents the number of groups pre-specified by the analyst. We can use different methods to define the optimal number of clusters k . In our paper, Elbow Method, Average Silhouette Method and Gap Statistic Method are used. The Elbow method can be defined as follows:

$$\min \left(\sum_{k=1}^k W(C_k) \right) \quad (3)$$

Where C_k is the k th cluster and $W(C_k)$ is the within-cluster variation. As presented by Kaufman and Rousseeuw (1990), the total sum of the square within a cluster measures the compactness of the grouping, and we want it to be as small as possible.

The second, the Average Silhouette Method, measures the quality of clustering. As mentioned by Young (2019), this method measures the quality of clustering by determining how well each lies within its cluster object. For a cluster to be a good quality cluster, an average silhouette width must be high. This method calculates the average silhouette of observations for different values of k . The optimal number of clusters is the maximum value of the average silhouette over an array of probable values for k .

The gap statistic has been published by Tibshirani et al. (2001). The gap statistic compares the total within intra-cluster variation for different values of k with their expected values under the null reference distribution of the data. The estimate of the optimal clusters will be the value that maximises the gap statistic. This means that

the clustering structure is far away from the random uniform distribution of points.

Within the last step of our analysis, we try to investigate the impact of financial development on agricultural growth by incorporating capital in the form of loans provided by banks to the agricultural sector, while land and labour represent important impulses of agricultural productivity. We employ a Cobb-Douglas production function, where, according to Čechura (2006), the general equation can be written as follow:

$$Y_t = \alpha \times Capital_t^b \times (Land/Employees)_t^c \times klnu_t \quad (4)$$

Where Y_t is the real output of the agricultural sector measured by gross value-added in current prices in the agricultural sector in time t , where $t = 1, 2, \dots, n$, $Capital_t^b$ indicates capital use in the agricultural sector measured in the form of loans provided by banks to the agricultural sector in time t , $(Land/Employees)_t^c$ indicates the ratio between agricultural land in m^2 and the number of employees in the agricultural sector in time t , and u_t is residual. As presented by Shahbaz et al. (2013), coefficient b and c indicates the marginal impacts of capital, land and labour on agriculture production, which follows the assumption of constant returns to scale. The formula (4) can be expressed in the linear form (after logarithmic transformation) as presented by Čechura (2006) in the following form:

$$\ln Y_t = \ln \alpha + b \ln Capital_t + c \ln (Land/Employees)_t + klnu_t \quad (5)$$

As mentioned by Shahbaz et al. (2013), the financial sector allocates funds to the farmers at a cheaper cost and enables them to utilise machinery and cultivate land to stimulate agriculture economic activity and hence agriculture growth. This implies that financial development enhances capitalisation in the agriculture sector that increases her contribution to gross domestic product and value-added, and enhances the productivity of the agricultural sector. Labour force is also an important determinant of agricultural production, as it contributes to agriculture growth by utilising the available technology in the agriculture production process. The last important determinant is the agricultural land, the active cultivation of which can also lead to economic growth in agriculture.

We use panel data for 8 Slovak regions during 2008-2019 to test the hypothesis that loans are

important factors that increase the agricultural output. We use data published on the web page of the Statistical Office within the DataCube and data about the loans provided by the National bank of Slovakia.

To test the hypothesis, the standard methodology for panel data was used. According to Baltagi (2014), the estimated model (5) needs to be tested to see if it meets model assumptions (whether it is a fixed-effect model with significant time and individual effects or a random-effect model), and we also apply the Hausman test to verify which one (fixed or random-effect model) is more appropriate to use. We must test whether the model meets the statistical assumptions made on such a type of econometric model. It is testing the significance of time, individual, or both types of effects in the case of a fixed-effect model (F test), cross-sectional dependency testing (Pesaran cross-sectional dependence test), serial correlation (Breusch-Godfrey test), and heteroskedasticity (Breusch-Pagan test). To verify if it is necessary to use a panel structure of the data frame we apply a Chow test. If the p-value of the Chow test is lower than 0.05 at a 95% significance level, then it is suitable to use a panel structure of the model. Otherwise, the basic linear regression model (OLS) can be used. In the case of OLS, the standard tests are used. The presence of heteroscedasticity is examined with the Breusch-Pagan test, autocorrelation is examined with the Durbin-Watson test, multicollinearity is examined with VIF test, and normality of residuals is examined with the Jarque-Bera Normality test.

Results and discussion

As the first step of the analysis, we explore the Slovak agriculture sector and bank credit in general. In Figure 2, we can see that the volume of loans provided in Slovakia constantly increases, along with the volume of loans provided in the agricultural sector. At the end of 2019, the agricultural sector borrowed 913.286 thousand of EUR from banks. In 2019, farmers borrowed funds for long-term loans over five years (39.69% of the volume of loans provided in the sector), as well as for short-term loans where repayments last less than a year (37.61%) and medium-term loans, over one to five years (22.7%).

If we look at the distribution of loans in Agriculture, forestry, and fishing among individual regions, we can see that almost 40% of the total volume of loans

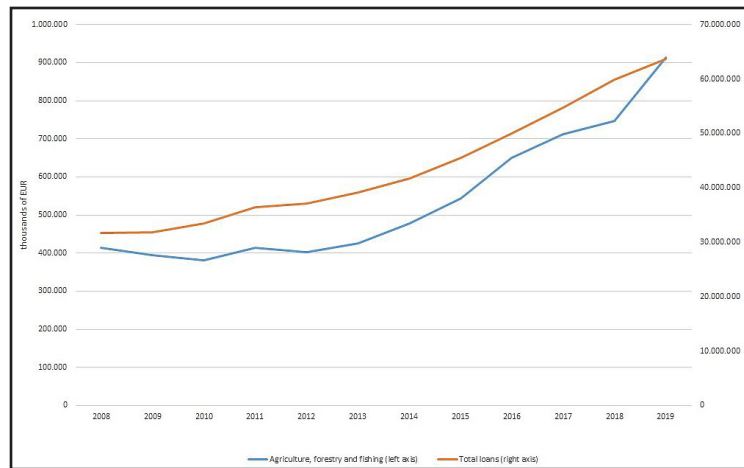

Source: Prepared by authors

Figure 2: Development of total loans and loans in Agriculture, forestry and fishing (thousands of EUR).

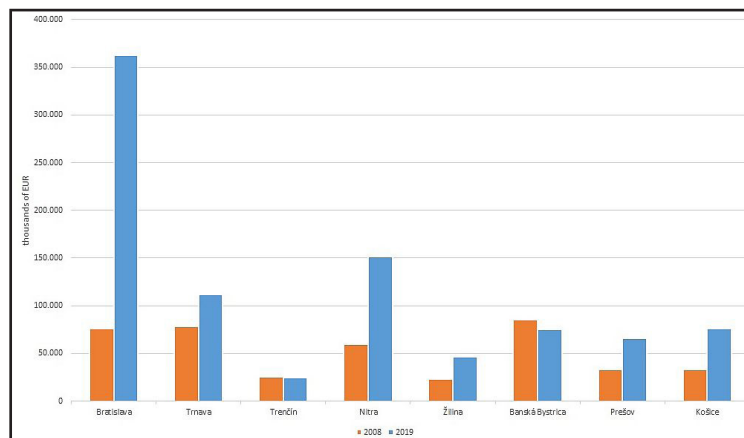

Source: Prepared by authors

Figure 3: The distribution of loans in Agriculture, forestry and fishing in regions of Slovakia (thousands of EUR).

in the agricultural sector in 2019 was provided in the Region of Bratislava. It was followed by the Region of Nitra (16.55%), the Region of Trnava (12.23%), the Region of Košice (8.3%), the Region of Banská Bystrica (8.24%), the Region of Prešov (7.19%), the Region of Žilina (5.09%) and the Region of Trenčín (2.71%). By comparing the volume of loans provided in individual regions in 2008 and 2019 (Figure 3), we can see that in all regions, there was an increase in the volume of loans provided by banks between the years, while the largest increase occurred in the Region of Bratislava.

Within the next step, we apply cluster analysis to analyse the similarities between Slovak regions from a different point of view, e.g. the employment in the agricultural sector, agricultural output, and agricultural land. We use data published on the web page of Statistical Office within

the DataCube about the number of employees in the agricultural sector, gross value-added in current prices in the agricultural sector, and agricultural land, and data about the loans provided to agricultural subjects presented by National bank of Slovakia. The descriptive statistics and correlation analysis for all variables during the whole analysed period 2008-2019 is presented in Table 1. The results of correlation analysis show that financial development (loans), land and labour (number of employees) are positively correlated with agricultural growth measured by gross value-added in the agricultural sector. There is a negative correlation found between land and the number of employees and financial development, while the correlation between labour and land is strong and positive.

The results of the optimal number of clusters for different criteria can be seen in Table 2.

	Gross value-added in current prices in the agricultural sector	Total loans in Agriculture, forestry and fishing	Number of employees in the agricultural sector	Agricultural land
	Mil. EUR	Thousands of EUR	Number	m ²
Mean	236	67442	4827	2998336127
Median	213	61354	4648	3125527963
Maximum	543	362405	10261	4686693132
Minimum	84	16679	1712	899246400
St.dev.	1 086 682	51542.04	1 737 903	1169321580
Kurtosis	0.2159	123 259	0.6324	-0.9033
Skewness	0.9658	29 152	0.4627	-0.3445
Total loans in Agriculture, forestry and fishing	0.2501	-	-	-
Number of employees in the agricultural sector	0.5783	-0.1836	-	-
Agricultural land	0.6964	-0.2251	0.8195	-

Source: Prepared by authors

Table 1: Descriptive statistics and correlation matrix.

	Loans – Agricultural output	Loans – Labour	Loans - Land
Elbow Method	4	4	4
Average Silhouette Method	2	4	9
Gap statistic Method	2	4	4

Source: Prepared by authors

Table 2: The optimal number of clusters.

According to all criteria, mostly four clusters was set up, we decide to present the results of our analysis for four clusters.

The clusters set up according to the value of loans provided in the agricultural sector and defined criteria (agricultural output, number of employees and agricultural land) are presented in Figure 4. According to the results presented in Figure 4, we can see that one cluster has a specific position within the analysis. We could see that cluster 4 in the case of agricultural output, and cluster 1 in the case of the number of employees and agricultural land put together regions with the highest level of loans while the agricultural characteristics do not below to the "best" one. Within this cluster, we can always see only the Bratislava region. This way, we can conclude that the level of provided loans is the highest one in the case of this region despite the fact that this region does not produce the highest level of agricultural output, does not employ the highest number of employees and does not cultivate the largest area of agricultural land.

Table 3 compares the volume of provided loans

in different clusters according to defined criteria. As can be seen, according to the first criterion within the fourth cluster, we can see regions with the highest volume of provided loans in the agricultural sector, while the highest value of agricultural output can be seen in the third cluster. In the case of the second criterion, the highest volume of provided loans is also not connected with the highest number of employees. On the contrary, it relates to the lowest number of employees. Also, in the third criterion, the highest volume of provided loans is not connected with the largest agricultural area but again relates to the smallest average value of the land.

We decide to apply all types of models: fixed-effect model (FE) for panel data, random-effect model (RE) for panel data and the ordinary least squares method (OLS) to estimate the parameters of the linear regression model. The Chow test results pointed out that it is not necessary to use the panel structure of the data frame. It means that the basic linear regression model could analyse the data, and additional tests for the basic linear regression model should be applied. The results

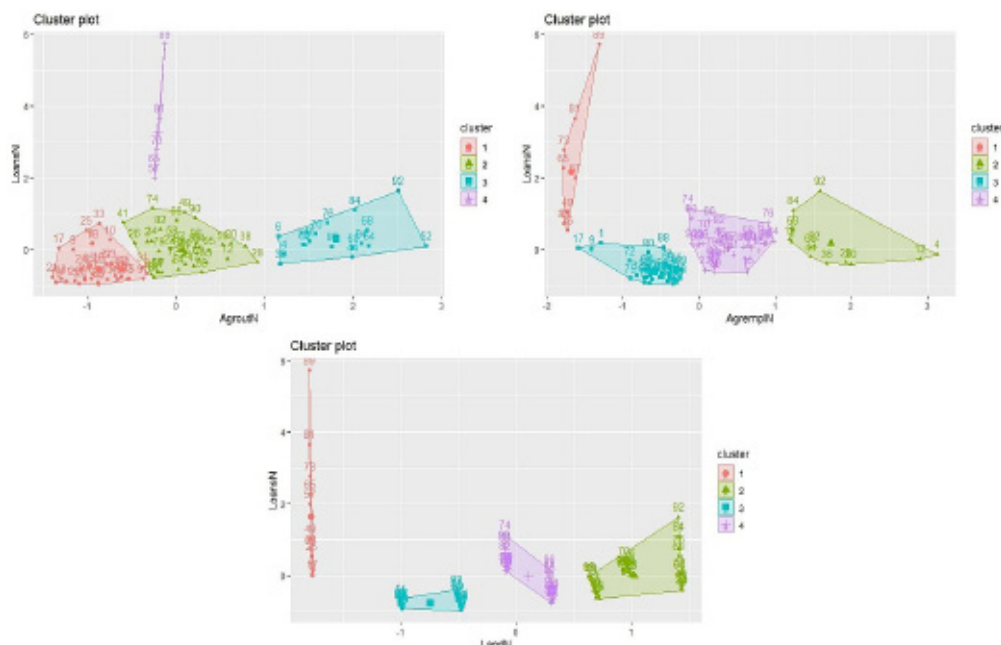

Source: Prepared by authors

Figure 4: Cluster analysis of Slovak regions.

	Criterion no. 1		Criterion no. 2		Criterion no. 3	
	Loans (thousands of EUR)	Agricultural output (mil. EUR)	Loans (thousands of EUR)	Labour (number of employees)	Loans (thousands of EUR)	Land (m²)
Cluster 1 (No. of regions)	39273	141	178566	1895	151587	914151860
	(37)	(37)	(9)	(9)	(12)	(12)
Cluster 2 (No. of regions)	66089	244	75276	7836	66844	4191373572
	(37)	(37)	(13)	(13)	(36)	(36)
Cluster 3 (No. of regions)	82050	433	34593	3815	27429	2128675227
	(17)	(17)	(37)	(37)	(24)	(24)
Cluster 4 (No. of regions)	236240	214	70509	5495	66280	3120532994
	(5)	(5)	(37)	(37)	(24)	(24)

Source: Prepared by authors

Table 3: The characteristics in different clusters (2008-2019).

of Hausmann test pointed to the fact, that in the case of panel data analysis the random-effect model (RE) is more appropriate.

We interpret the results of the test in the linear regression (OLS) model in Figure 5 and Table 4. The first plot, "Residuals vs Fitted" shows if residuals have linear or non-linear patterns. As presented by Kim (2020), there could be a non-linear relationship between predictor variables and an outcome variable, and the pattern could show up in this plot if the model does not capture the non-linear relationship. If we find equally spread residuals around a horizontal line without distinct patterns, that is a good indication we do not have non-linear relationships.

In our analysis, we can see that data is simulated in a way that meets the regression assumption, which corresponds to a red line where the points are centred around the zero value. So, we can conclude that it is appropriate to apply a linear regression model. The second plot, "Normal Q-Q" shows if residuals are normally distributed. In our sample, residuals follow a straight line so we can conclude that they are normally distributed. The third plot, "Scale-Location" shows if residuals are spread equally along with the ranges of predictors. This is how we can check the assumption of equal variance (homoscedasticity). It is good if we see a horizontal line with equally (randomly) spread points. According to the results presented in our plot, we can conclude that residuals appear randomly

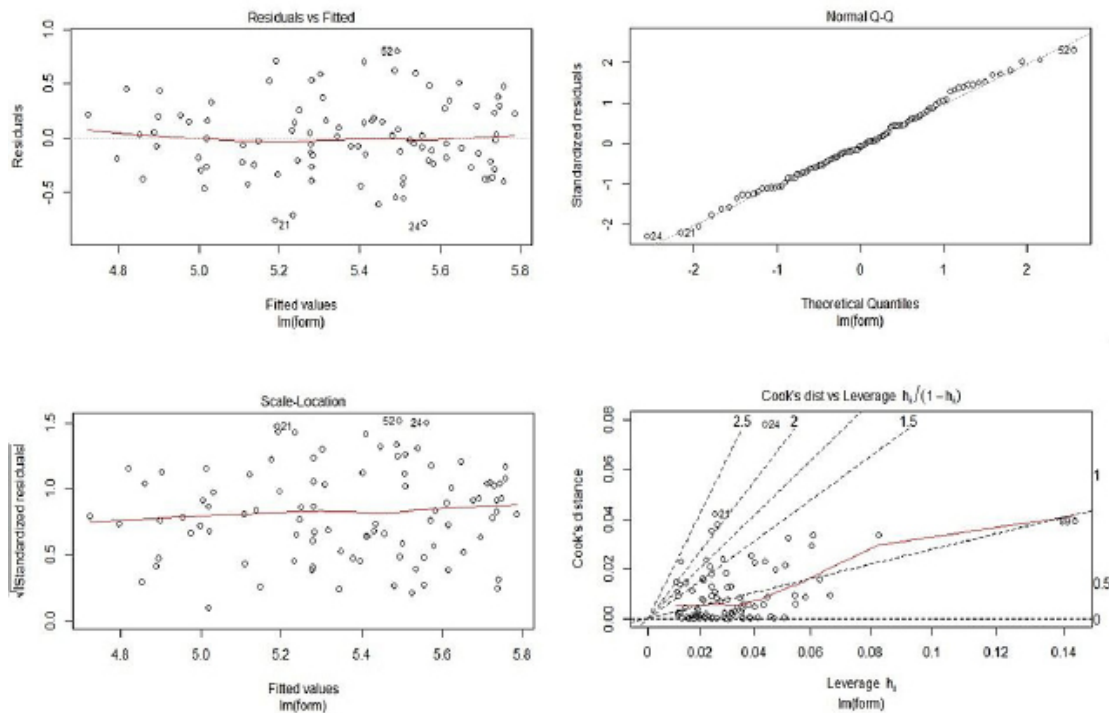

Source: Prepared by authors

Figure 5: Results of regression analysis.

spread. In the last plot, "Cook's distance vs leverage", contours of standardised residuals that are equal in magnitude are lines through the origin. The contour lines are labelled with magnitudes. Cook's distance is large if either the observation has a large residual or if it exerts high leverage on the model. As we can see from the plot, there is a value at the top of the left corner, which has a high residual (2.5) but not necessarily large leverage. In the bottom of the right corner, the converse is true, where we can see value with high leverage but low residuals (0.5). Finally, we can conclude that there are not any outliers that negatively affect our regression model.

We also applied a standard methodology for panel data. We tested if it is suitable to apply the fixed-effect model (FE) with significant time, individual or both effects. As shown in Figure 6 and in Table 4, the F test results pointed out that it is necessary to use both effects. There exists heterogeneity across regions and also heterogeneity across years.

The results of model testing and the estimated regression coefficients for a fixed-effect model (FE), random-effect model (RE) and linear model (OLS) are shown in Table 4.

The model summary result states that the coefficient of determination R-squared varies between 31.35% and 39%. It implies that explanatory variables are

explaining the dependent variable up to 31.35%. F-statistics reveals that the models are significantly robust. In the case of panel data analysis (FE and RE model), we can see that volume of provided loans in the agricultural sector has a significant and positive impact on the growth in the agricultural sector. The results of the Pesaran cross-sectional dependence test (CD test) points to the fact that there is cross-sectional dependence in the panel. Also, the Breusch-Godfrey test (PBG test) points to serial correlation in panel models. The results of the Breusch-Pagan test (BP test) shows that there is no problem with heteroskedasticity.

In the OLS model, the result of the Breusch-Pagan test (BP test) shows that there is no heteroscedasticity. Also, the result of the VIF test pointed to the fact that there is no problem with multicollinearity, the result of the Jarque-Bera (JB) Normality test shows that residuals have a normal distribution, and the result of the Durbin-Watson test (DW test) shows there is no problem with autocorrelation. As shown in Table 4, the statistically significant variables are identified: the volume of provided loans and agricultural land in relation to the number of employees. The relationship between agricultural output and both variables is positive and statistically significant. Keeping other things constant, a 1 per cent increase in the volume of provided

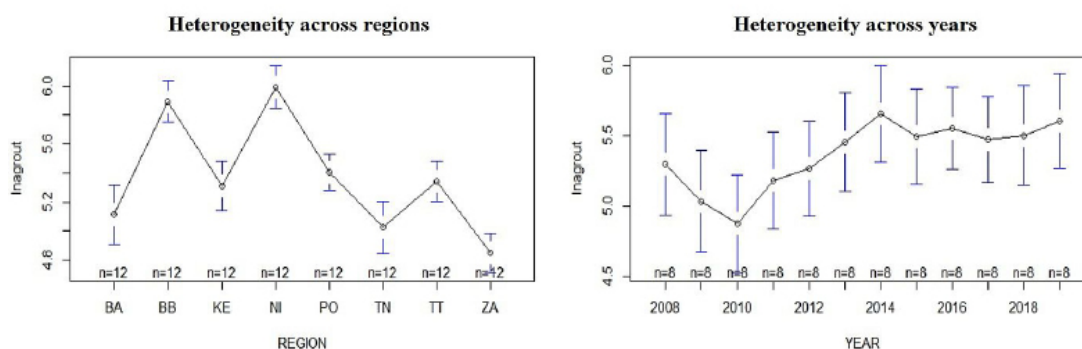

Source: Prepared by authors

Figure 6: Individual and time effects.

	FE model	RE model	OLS
Intercept		-1.5921	-8.6416
		(2.5252)	(2.1653) ***
ln(Loans)	0.428	0.4167	0.3733
	(0.0685) ***	(0.0655) ***	(0.0582) ***
ln(Land/Employees)	0.0905	0.1811	0.7464
	(0.1967)	(0.1857)	(0.1504) ***
Sample size	Balanced Panel: n=8, T=12, N=96		
R-Squared	0.318	0.3135	0.39
Time effects (F test)	Yes	Yes	-
Individual effects (F test)	Yes	Yes	-
CD test	Yes	Yes	-
PBG test	Yes	Yes	-
BP test	No	No	-
F-statistics	Yes	Yes	Yes
BP test	-	-	No
DW test	-	-	No
JB Normality test	-	-	Yes
VIF test	-	-	No

Note: **** 0.01 *** 0.05 ** 0.1. Robust standard errors appear in parentheses below estimated coefficients

Source: Prepared by authors

Table 4: Determinants of agricultural growth.

loans in the agriculture sector will stimulate growth in value-added in the agriculture sector by 0.3733 per cent. The next statistically significant variable is agricultural land in relation to the number of employees, where the 0.7464 per cent growth in value-added in the agriculture sector is linked with a 1 per cent increase in agricultural land. It indicates that land and labour play a vital role in the production of the agriculture sector. This result is in line with Čechura (2006), or Shahbaz et al. (2013), who also pointed to the fact that financial development is crucial for agricultural development. The results indicate that financial development has a positive impact on agricultural growth. This implies that financial development plays its significant role in stemming agricultural

production and hence agricultural growth. The land use in the agriculture sector in relation to the labour force in agricultural sector is also an important factor in stimulating agriculture production.

Conclusion

The role of commercial banks is essential for contribution to general prosperity for each country's economy. Banks provide many services to their clients and raise the level of economic development of the whole country. When we want to examine the issue of the role of banks more specific, one of the options is to observe individual sectors. An analysis of the agricultural credit in Europe reveals that the agricultural sector

of several countries has a significant share in the volume of loans. Bank credit in agriculture has been a subject of discussion of many studies; even there is a lack of these studies in Europe. The purpose of this paper is to analyse the role of banks in the Slovak agricultural sector with the application of cluster analysis and employing the Cobb-Douglas function from 2008 to 2019.

In this study, we analysed credit development in the agricultural sector in Slovakia from various perspectives. The results pointed to the fact that commercial banks are crucial in financing agricultural sectors. Agricultural subjects in Slovakia go to banks for medium, short-term, and long-term loans, which they use on various activities to increase their agricultural production.

The cluster analysis results, which examined the relationship between the characteristics of the agricultural sector and the volume of funding at the regional level, pointed to the fact that there exist regional disparities between Slovak regions. Bratislava region tends to be the region with the highest levels of provided loans despite the fact that this region does not produce the highest level of agricultural output, does not employ the highest number of employees and does not cultivate the largest area of agricultural land. This can be influenced by the fact that some agricultural subject may have authority in the Bratislava region but operating in another region. This could

be verified based on aggregated data published on the National Bank of Slovakia and the Statistical Office website. Therefore, the use of data at the farm level to examine the relationship between the location of authority and the place of activity of the agricultural operators may be subject to further analysis.

Within the last step of our analysis, we examined whether the development of the financial market expressed in the form of the value of provided loans in the agricultural sector can be considered an important factor in the development of agriculture in the Slovak regions during the period 2008-2019. We have found out that there exists a significant and positive relationship between the volume of provided loans and gross value-added in the Slovak agricultural sector. So, we can suppose that financial development plays a significant role in agricultural production and agricultural growth in Slovakia, which confirmed our hypothesis that loans are important factors that increase agricultural output.

Acknowledgements

This paper was supported by the Slovak Scientific Grant Agency as a part of the research project No. VEGA 1/0794/18 "Development of a methodological platform for evaluation of efficiency in the financial and non-financial sector".

Corresponding authors

Assoc. prof. Kristína Kočíšová, Ph.D.

*Department of Banking and Investments, Faculty of Economics, Technical University of Košice
Němcovej 32, 040 01 Košice, Slovak Republic*

E-mail: kristina.kocisova@tuke.sk

ORCID: 0000-0003-0784-441X

References

- [1] Agbodji, A. E. and Johnson, A. A. (2019) "Agricultural Credit and Its Impact on the Productivity of Certain Cereals in Togo", *Emerging Markets Finance and Trade*, pp. 1-17. ISSN 1540-496X. DOI 10.1080/1540496X.2019.1602038.
- [2] Ammani, A. A. (2012) "An Investigation into the Relationship between Agricultural Production and Formal Credit Supply in Nigeria", *International Journal of Agriculture and Forestry*, Vol. 2, No. 1, pp. 46-52. E-ISSN 2165-8846, ISSN 2165-882X. DOI 10.5923/j.ijaf.20120201.08.
- [3] Andersson, F. N., Burzynska, K. and Opper, S. (2016) "Lending for growth? A Granger causality analysis of China's finance-growth nexus", *Empirical Economics*, Vol. 51, No. 3, pp. 897-920. ISSN 1435-8921. DOI 10.1007/s00181-015-1034-8.
- [4] Baltagi, B. H. ed. (2015) *"The Oxford handbook of panel data"*, Oxford Handbooks. ISBN 978-0-19-994004-2. DOI 10.1093/oxfordhb/9780199940042.001.0001.

- [5] Baráth, L. and Fertő, I. (2017) "Productivity and convergence in European agriculture", *Journal of Agricultural Economics*, Vol. 68, No. 1, pp. 228-248. ISSN 1477-9552. DOI 10.1111/1477-9552.12157.
- [6] Čechura, L. (2006) "The role of credit rationing in Czech agriculture—the case of large agricultural enterprises", *Agricultural Economics–Czech*, Vol. 52, No. 10, pp. 477-488. ISSN 1805-9295. DOI 10.17221/5054-AGRICECON.
- [7] Čechura, L., Grau, A., Hockmann, H., Kroupová, Z. and Levkovych, I. (2014) "Total Factor Productivity in European Agricultural Production", COMPETE Working Paper, No. 9, DOI 10.13140/RG.2.1.3856.9367.
- [8] Chisasa, J. (2014) "An empirical study of the impact of bank credit on agricultural output in South Africa", University of South Africa, PhD Thesis. [Online]. Available: <http://uir.unisa.ac.za/handle/10500/18511>. [Accessed: 12 Dec. 2020].
- [9] Das, A., Senapati, M. and John, J. (2009) "Impact of Agricultural Credit on Agriculture Production: An Empirical Analysis in India", *Reserve Bank of India Occasional Papers*, Vol. 30, No. 2, pp. 75-107. ISSN 0972-7493.
- [10] Ekwere, G. E. and Edem, I. D. (2014) "Evaluation of Agricultural Credit Facility in Agricultural Production and Rural Development", *Global Journal of Human Social Science*, Vol. 14, No. 3, pp. 19-26. ISSN 2249-460X.
- [11] European Environment Agency (2017a) "*Climate change, impacts and vulnerability in Europe 2016*", Publications Office of the European Union, Jan. 2017. [Online]. Available: <https://www.eea.europa.eu/publications/climate-change-impacts-and-vulnerability-2016>. [Accessed: 10 Dec., 2020].
- [12] European Environment Agency (2017b) "*Landscapes in transition - An account of 25 years of land cover change in Europe*", Publications Office of the European Union, Sep., 2017. [Online]. Available: <https://www.eea.europa.eu/publications/landscapes-in-transition> [Accessed: 10 Dec., 2020].
- [13] European Environment Agency (2020) "*Agriculture*", Publications by European Environment Agency, Jan. 2020. [Online]. Available: <https://www.eea.europa.eu/sk/themes/agriculture> [Accessed: 10 Dec. 2020].
- [14] Fecke, W., Feil, J. H. and Musshoff, O. (2016) "Determinants of loan demand in agriculture empirical evidence from Germany", *Agricultural Finance Review*, Vol. 76, No. 4, pp. 462-476. ISSN 0002-1466. DOI 10.1108/AFR-05-2016-0042.
- [15] Food and Agriculture Organization of the United Nations (2018) "*Credit to agriculture*", Food and Agriculture Organization of the United Nations., Oct. 2018. [Online]. Available: <http://www.fao.org/economic/ess/investment/credit/en/> [Accessed: 26 Nov. 2020].
- [16] Hussain, A., Ali, M., Bilal, M. and Nawaz, I. (2015) "Impact of Insitutional Credit on Agriculture Production in Pakistan: A Time Series Analysis", *World Applied Sciences Journal*, Vol. 33, No. 7, pp. 1118-1124. ISSN 1818-4952.
- [17] Juszcyk, S. (2018) "The influence of loans agriculture on net profit of cooperative banks in Poland", *Problems of Agricultural Economics/Zagadnienia Ekonomiki Rolnej*, Vol. 4, No. 357, pp. 60-79. ISSN 0044-1600. DOI 10.30858/zer/100701.
- [18] Kalusova, L. and Badura, P. (2017) "Factors determining the financial structure of Czech and Slovak agricultural enterprise", *Agricultural Economics*, Vol. 63, No. 1, pp. 24-33. ISSN 1805-9295. DOI 10.17221/325/2015-AGRICECON.
- [19] Kaufman, L. and Rousseeuw, P. J. (1990) "*Finding Groups in Data: An Introduction to Cluster Analysis*", John Wiley & Sons, Vol. 344, ISBN 9780471878766. DOI 10.1002/9780470316801.
- [20] Khan, W., Fatima, S. and Jamshed, M. (2017) "Agricultural Credit-led Agricultural Growth: A VECM Approach", *Asian Journal of Agricultural Extension, Economics & Sociology*, Vol. 19, No. 1, pp. 1-16, ISSN 2320-7027. DOI 10.9734/AJAEES/2017/32304.

- [21] Kijek, A., Kijek, T., Nowak, A. and Skrzypek, A. (2019) "Productivity and its convergence in agriculture in new and old European Union member states", *Agricultural Economics*, Vol. 65, No. 1, pp. 1-9. ISSN 1805-9295. DOI 10.17221/262/2017-AGRICECON.
- [22] Kim, B. (2020) "*Understanding Diagnostic Plots for Linear Regression Analysis*", University of Virginia Library. Sep. 2015. [Online]. Available: <https://data.library.virginia.edu/diagnostic-plots/khk> [Accessed: Nov 26, 2020].
- [23] Koester, U. (2016) "*Grundzüge der landwirtschaftlichen Marktlehre*", 4th ed. in 2010, 413 p., mit vielen Übersichten und Schaubildern. Softcover Vahlen. ISBN 978-3-8006-3764-5. (in German).
- [24] Laborde, D. and Piñeiro, V. (2018) "Monitoring agricultural productivity for sustainable production and R&D planning", *Economics: The Open-Access, Open-Assessment E-Journal*, Vol. 12, No. 2018-66, pp. 1-11. ISSN 1864-6042. DOI 10.5018/economics-ejournal.ja.2018-66.
- [25] Mohan, R. (2006) "Agricultural Credit in India: Status, Issues and Future Agenda", *Economic and Political Weekly*, Vol. 41, No. 11, pp. 1013-1023. ISSN 2349-8846.
- [26] Narayanan, S. (2015) "The productivity of agricultural credit in India", *Agricultural Economics*, Vol. 47, No. 4, pp. 399-409. ISSN 0169-5150. DOI 10.1111/agec.12239.
- [27] Nowak, A., Janulewicz, P., Krukowski, A. and Bujanowicz-Haraś, B. (2016) "Diversification of the level of agricultural development in the member states of the European Union", *Cahiers Agricultures*, Vol. 25, No. 5, 7 p. ISSN 1166-7699. DOI: 10.1051/cagri/2016040.
- [28] Obilor, S. I. (2013) "The Impact of Commercial Banks' Credit to Agriculture on Agricultural Development in Nigeria: An Econometric Analysis", *International Journal of Business, Humanities and Technology*, Vol. 3, No. 1, pp. 85-94. ISSN 2162-1381.
- [29] Oyelade, A. O. (2019) "Impact Of Commercial Bank Credit On Agricultural Output In Nigeria", *Review of Innovation and Competitiveness: A Journal of Economic and Social Research*, Vol. 5, No. 1, pp. 5-20. ISSN 1849-9015. DOI 10.32728/ric.2019.51/1.
- [30] Rabek, T. (2006) "The Analyse Of Long-Term And Short-Term Bank Credits In Slovak Agriculture", In: *Actual problems solved in agrocomplex*, Slovak University of Agriculture in Nitra. pp. 471-476. ISBN 80-8069-799-X. (in Slovak).
- [31] Ramakumar, R. and Chavan, P. (2014) "Bank Credit to Agriculture in India in the 2000s: Dissecting the Revival", *Review of Agrarian Studies*, Vol. 4, No. 1, pp. 50-79. ISSN 2248-9002.
- [32] Rogach, S., Vdovenko, L. and Polishchuk, O. (2019) "Agriculture of Ukraine under the joint policy of the European Union", *Baltic Journal of Economic Studies*, Vol. 5, No. 3, pp. 178-183. ISSN 2256-0742. DOI 10.30525/2256-0742/2019-5-3-178-183.
- [33] Shabir, M., Amin, K., Muhammad, A. and Ahmad, J. (2020) "Impact of Agricultural Credit on Cereal Productivity: Case Study of District Sargodha, Punjab Pakistan", *Theoretical Economics Letters*, Vol. 10, No. 3, pp. 481-487. ISSN 2162-2078. DOI 10.4236/tel.2020.103030.
- [34] Shahbaz, M., Shabbir S. M. and But, S. M. (2013) "Effect of financial development on agricultural growth in Pakistan: New extensions from bounds test to level relationships and Granger causality tests", *International Journal of Social Economics*, Vol. 40, No. 8, pp. 707-728. ISSN 0306-8293. DOI 10.1108/IJSE-01-2012-0002.
- [35] Shan, J. and Morris, A. (2002) "Does financial development 'lead' economic growth?". *International Review of Applied Economics*, Vol. 16, No. 2, pp. 153-168. ISSN 0269-2171. DOI 10.1080/02692170110118885.
- [36] Skriniarova, K. and Bandlerova, A. (2012) "Zhodnotenie finančnej situácie v poľnohospodárskom sektore", *Business in European Union, Trade Law EU II: collection of papers from international scientific conference*, Vol. 11, pp. 145-151. ISBN 978-80-552-0819-0. (in Slovak).
- [37] Tibshirani, R., Walther, G. and Hastie, T. (2001) "Estimating the number of clusters in a data set via the gap statistics", *Journal of the Royal Statistical Society: Series B (Statistical Methodology)*, Vol. 63, No. 2, pp. 411-423. ISSN 1467-9868. DOI 10.1111/1467-9868.00293.

- [38] Toby, A. J. and Peterside, D. (2014) "Analysis of the role of banks in financing the agriculture and manufacturing sectors in Nigeria", *International Journal of Research in Business Management*, Vol. 2, No. 2, pp. 9-22. ISSN 2321-886X.
- [39] Toth, M., Rabek, T. and Strapekova, Z. (2020) "Impact of Integration and Globalisation on Business Risk and loans in Slovak Agriculture", *The 19th International Scientific Conference Globalization and its Socio-Economic Consequences 2019 – Sustainability in the Global-Knowledge Economy*, Vol. 74, 2020. ISSN 2261-2424. DOI 10.1051/shsconf/20207405027.
- [40] Varraso, I. and Dimitrio, A. (2020) "Impact of the global economic crisis on bank loans in agriculture in Italy and in Apulia (2010-2013)", *Geotema*, Vol. 52, pp. 71-87. ISSN 1126-7798.
- [41] Yaya, S., Xi, C., Xiaoyang, Z. and Meixia, Z. (2020) "Evaluating the efficiency of China's healthcare service: A weighted DEA-game theory in a competitive environment", *Journal of Cleaner Production*, Vol. 270. ISSN 1879-1786. DOI 10.1016/j.jclepro.2020.122431.
- [42] Young, K. G. (2019) "Disease endotypes of type 1 diabetes: Exploration through machine learning and topological data analysis", Rutgers University-School of Health Professions, PhD Thesis. [Online]. Available: <https://rucore.libraries.rutgers.edu/rutgers-lib/60605/> [Accessed: Nov 15, 2020].

Smart Agricultural Decision Support Systems for Predicting Soil Nutrition Value Using IoT and Ridge Regression

Mohan Kumar Sudha, Maharana Manorama, Tarigoppula Aditi

School of Information Technology and Engineering, Vellore Institute of Technology, Vellore Campus, India

Abstract

Cost effective agricultural crop productivity is an everlasting demand, this predominant expedition has raised a global shift towards practicing smart agricultural methods to increase the productivity and the efficiency of the agricultural sector, using IoT. This research identified the benefits and the challenges in IoT adoption as an alternate for out-of-date agricultural practices. The proposed decision support system using IoT for Smart Soil Nutrition Prediction (SSNP) adopts IR sensors and implements diffuse reflectance infrared spectroscopy. Information is transferred using Arduino and Zigbee protocol. It has indicated precise outcomes in various studies giving a high repeatable, low cost and fast estimation of soil properties. The measure of light absorbed by a soil example is estimated, inside several particular wavebands over a scope of frequencies to yield an infrared range utilizing an IR sensor. Using the given values, the experimental analysis using the dataset and the nutrition values of the soil such as Ca, P, SOC, Sand and pH are predicted. This proposed IoT framework would enhance the farmer's knowledge regarding the type of crops they should grow to get maximum profit from their agricultural produce.

Keywords

Agriculture, Internet of Things (IoT), IoT in agriculture, IoT sensors, IR Sensor, Regression, Smart agriculture.

Sudha, M. K., Manorama, M. and Aditi, T. (2022) "Smart Agricultural Decision Support Systems for Predicting Soil Nutrition Value Using IoT and Ridge Regression ", *AGRIS on-line Papers in Economics and Informatics*, Vol. 14, No. 1, pp. 95-106. ISSN 1804-1930. DOI 10.7160/aol.2022.140108.

Introduction

IoT, Data analytics and wireless systems support crop yield maximization that can automate day to day agricultural activities as well as offers real time monitoring and predictions for automated decision making.

Connected sensors possess various communication sensor connections, monitoring controls and so on to help farmers analyse their field and for a better operation. Using embedded wireless devices and other IOT systems can help measure moisture and nutrients in the soil and efficiently manage the energy usage. It is important to take note of such large scale solutions that are scalable for a better future in the agricultural industry. The benefits of including IoT in agriculture can be listed as follows.

- 1. Community Farming:** IoT can be utilized so as to accommodate a common data storage where the farmers and agriculture specialists can connect and share information/data. Additionally through portable applications

and the IoT facilities, the simplicity of communication can be expanded by means of free/paid services.

- 2. Safety Control and Fraud Prevention:** As much as sufficient production is of concern, the safety and nutrition of the food supply is also important and needs to be noted.
- 3. Wealth Creation and Distribution:** IoT deployment will produce new plans of action where the middle-men idea can be skipped and the farmers can be in direct relations with their clients prompting higher authentic benefits.
- 4. Cost Reduction:** Since The capacity to realize when to apply pesticides with the assistance of IoT will diminish cost.
- 5. Operational Efficiency:** Operational efficiency relates to farmers, government and non government agencies. The data collected using IoT can serve in making decisions on how one could prevent

the spread of diseases, avoid fire outbreaks, generate compensation schemes and allocate resources. With the help of data analytics, farmers can take timely decisions on farm processes and its management.

With our proposed solution, we aim to minimize losses and the cost of travel by providing farmers a clear understanding on the soil nutrition content using diffuse infrared spectroscopy. Using our smart solution combined with analytics, we aim to convey the farmer a clear idea on the values of Calcium, Phosphorus, Organic Content, pH and sand content present in the soil sample with the use of IR sensors.

Elijah et al. (2018) stated that the IoT ecosystem for agricultural domain contains four important components which are: the IoT devices, the technology used for communication, as well as Internet and data storage. Various applications could be viable such as monitoring, agriculture machinery, precision agriculture, tracking and tracing and greenhouse production. On studying further, the various issues found are to be under the broad categories of business, technical, and sectoral issues. The future trends they proposed on the basis of their study are: technological innovations, application scenarios and business and marketability.

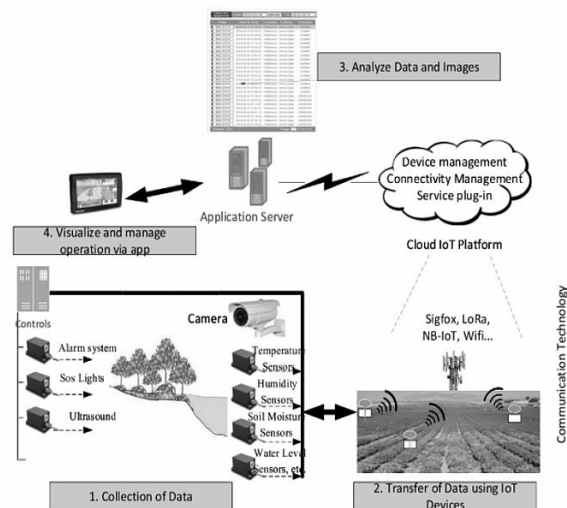

Source: Own processing

Figure 1: Architecture of proposed SSSNP model using data analytics and IOT.

They propose the usage of LPWA due to its low power consumption and long range communication. However, the infrastructure for LPWA is still being developed and it is not an open standard yet.

For security, they use signcryption (data encryption + digital signature) to protect sensitive data. The disadvantage of signcryption is that it uses multiple machine cycles that increases the computational power usage. For communication, they use NB-IoT technologies to ensure the quality of service. However, NB-IoT offers low data rate and does not provide for voice transmission. Jat et al. (2019) mentioned certain considerations to be made while designing an IoT system: Hardware considerations, data acquisition, data processing and storage, connectivity, power source, physicality of the device, cost, security and software considerations. Various monitoring techniques can be used such as: detecting soil moisture, soil pH and nutrients, humidity, temperature, rain, sunshine and image monitoring to analyse the health of crops under various conditions. They then transfer the data using Zigbee or WiFi.

Using WiFi promotes mobility, productivity and deployment. However, certain disadvantages include comparatively weaker security, low range and speed. In case zigbee is used, the advantages would include flexible network structure, easy to implement along with long battery life and low power consumption. But there are major disadvantages considering the security and low transmission rates as compared to WiFi. Further after data storage and processing, the device can be automated and brought to use (Jat et al., 2019). Using a Raspberry Pi has its advantages such as low cost and easy to handle the light/ internal web traffic. But it cannot be used on X86 Operating systems.

Another method used by Salam and Shah (2019) is Precision farming. Through the utilization of different methodologies and technologies, alongside leveraging existing framework, by including progressed phenotyping and hereditary qualities, new strategies can be created so as to increase greatest yield and nourishment while preserving water assets. However, apart from lack of training, the other factors hindering the precision farming selection are: cost, quantifiable profit and absence of precision agribusiness big data analytics (Salam and Shah, 2019). The advancement of some test beds as well as stages are done so as to actualize any new precision horticulture advances for checking, planting, and reaping through farmer or the scholarly world commitment that will help in innovation. The information on different sorts of soil frameworks would significantly help in adding to the improvement

of better underground sensing procedures. The major advantage of precision farming is that it enhances the agricultural produce by using water resources efficiently and also helps in preventing soil degradation. GPS trackers allow monitoring of fields and the method also reduces the effect of harmful environmental impact. However, the disadvantages include the cost and collection of data. Data collection and analysis is something that would take several years before one can implement this technique (Figure 2).

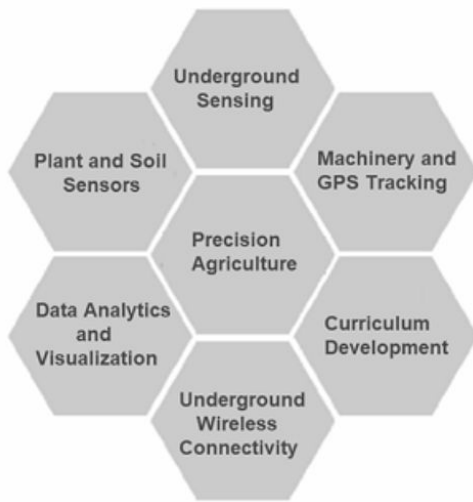

Source: Own processing
Figure 2: Overview of precision agriculture.

The re-emerging recession worldwide, that has caused some flows along the developed as well as the developing economies (Lakhwani et al., 2019). The domain of agriculture needs to be not only competent but also irreplaceable in order to ensure universal food security. Various applications have been stated such as sensor technology, RFID technology, Intelligent irrigation, radio transmission, precision seeding and spraying. The paper also states the various benefits in IOT that include: efficiency in input, cost reduction, profitability, sustainability, food safety and environment protection.

The proposed model by Prathibha et al. (2017) suggests the below architecture that is portable, low power, battery-operated, secure and has a fast connection. They analyse environmental conditions variations that will affect the overall yield of the crop. Since plants require proper monitoring and support, they used sensors to keep a track on the conditions to ensure optimal growth. Sensors used include, temperature infrared thermopile sensor- TMP007 and humidity sensor- HDC1010.

A camera is attached with a CC3200 camera booster pack via PCB using an MT9D111 camera sensor. It gives the data about the temperature, dampness in rural fields through a MMS to the farmer, on the off chance that it deviates off from the optimal range (Figure 3).

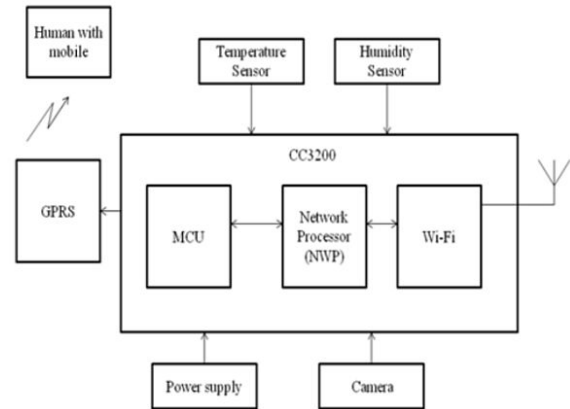

Source: Own processing
Figure 3: Architecture diagram using Node MCU and sensors.

The above model uses Node MCU that may not be as powerful as Raspberry Pi but it is the best fit in the current problem statement since it's cheaper and one can exploit the inbuilt TCP/IP configuration along with the WiFi support without the explicit need to conduct heavy operations using multithreading.

Gayatri et al. (2015) have recommended another technique using various sensors and factors like principle of transduction, input parameter and the properties that it has to measure. Sensors such as DHT11 can predict both the temperature and humidity at the same instant. They make use of ZigBee sensor nodes to obtain natural parameters like temperature, humidity and illumination information which are transmitted to the remote monitoring centre.

The customizations that are carried out are non-localization of memory and the input data is directly transferred to the datacenter in the cloud for processing. The data centers help in processing the incoming data and then compare the values to the inbuilt threshold value. Then they further pass on this information to the farmer's console application.

Communication between the sensor nodes and the data centers is done by using CDMA, 3G and 2 G wireless broadband networks. 3G provides for efficient phone calls, emails or text but the performance significantly decreases when

it comes to audio or video. Whereas 2G has a low rate of battery consumption and provides more data for an equivalent price.

Finally, in this method, water actuators will be made to water the plants immediately they sense that there is necessity for the plants to be watered (Figure 4).

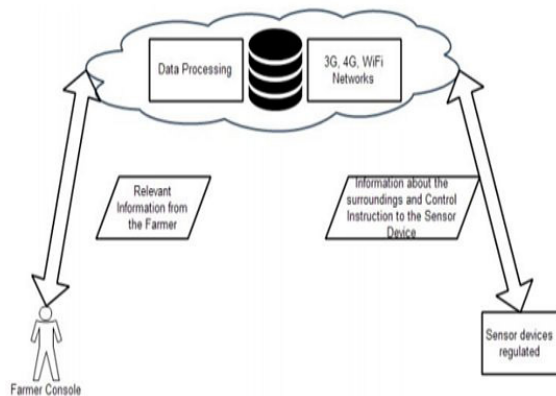

Source: Gayatri et al. (2015)

Figure 4: Architecture diagram using sensors and 3G/2G networks.

Patil and Kale (2016) proposed a model for smart agriculture which can be used to develop a monitoring system which is real time for properties of soil like temperature, soil moisture, and soil pH as well as to implement some decision support advisory models for the pest and disease advance warning, Crop Disease identification using image analysis and SMS based alerts.

It comprises of sensing local agricultural parameters, identification of location of the sensor and data collection, transfer of data from crop fields for decision making, support, actuation and control based on the crop monitoring performed using the camera Module. The first layer (perception) consists of a Ubi-Sense mote which is a generic sensor board that has various sensors concerning Temperature and Relative Humidity, Light Intensity, Atmospheric Pressure and so on. Convenient wireless connection and fast access to equipment within a short-distance can be achieved using ZigBee technique that uses WINGZ (Wireless IP Network Gateway since Zigbee fits a small-size and a low-cost wireless network that lies between the WPAN and IP network. Zigbee is a flexible network structure that is easy to implement along with long battery life and low power consumption. But there are major disadvantages considering the security and low transmission rates as compared to WiFi. In the application layer, the framework

can get and examine climate data from the web, remembering weather forecasts for the earlier days. The database then stores sensor data, streaming data, the geological data and various environmental reference values for notifying conditions into each database, and then creates an average statistical information by using the collected information. This is used to monitor crops and give alerts as and when required.

Zhao, Zhang, Feng and Li (2010) have proposed an “Agriculture greenhouse production environment measurement and control system” that uses IOT in agriculture. The basic temperature, dampness and soil signals are gathered constantly in the agriculture production process, which is sent utilizing wireless networks through the M2M (machine to machine) support stage. It is done in order to get some instantaneous information about the agricultural production environment by means of SMS, the World Wide Web, wireless application protocol (WAP) pattern, so that the terminal can use this information to guide the production. (Zhao et al., 2010) The WAP has various advantages such as real time communication of data, the multi platform functionality and the control of the appearance such as the layout and formatting for better user interface.

However, the disadvantages include cost, low speeds and low security provisions along with access to third party platforms. The estimation of these actual factors can be changed over into a low volt electric sign through a transmitter. This can be transmitted to the wireless communication terminal. The application interface shows customers information that include each greenhouse gas detection point, real-time data of air temperature and humidity, soil temperature, 24-hour, a week, or a month's curve and so on. Customers can set some alarm value, and this information can be conveyed to the manager's phone via SMS. This is done when the data is more than alarm value.

Mat et al. (2018) proposed a smart agriculture model using IOT, The Central Processing Unit (CPU) contains a microcontroller that interprets the input signals and executes control measures, in accordance with the programs stored in memory, and then further communicates the decisions they take as control signals to the output interface. The internal memory is used to perform the control measures and the programming tools are used to insert the required programs into memory.

Finally, GUI is a device that provides processed data onto the machine to the farmer and the farmers can control the equipment through GUI at the control centre. The most important part of the GUI is an alarm feature. Alarm is a digital state of NORMAL or ALARM. They tested this model on mushrooms and found that using their proposed model, the mushrooms are thicker and healthier with appropriate environmental conditions. Mat, et al. (2018) proposed an "A precision agriculture management system based on the Internet of Things and WebGIS that uses 3S, Internet of Things, network and communication techniques as its system support, to collect the data from various sources (Figure 5).

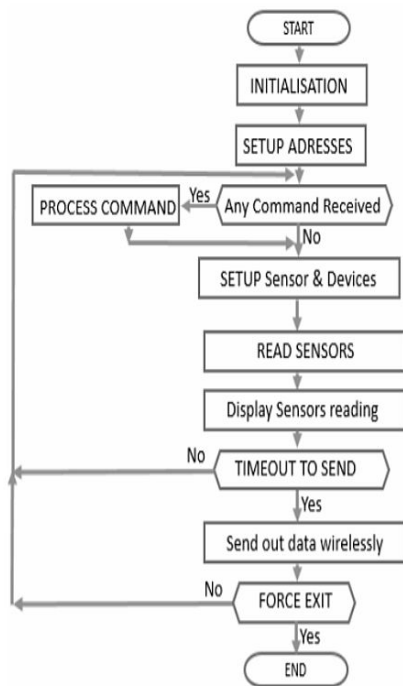

Source: Own processing

Figure 5: Overview of proposed SSNP model process flow diagram.

It uses both IOT and WebGIS. WebGIS is easy to implement, flexible and has a low cost barrier. It supports real time spatial analysis and connects to multiple structured sources of data. The system firstly receives data in real time using RFID, sensor and a 2D code technique; then secondly it transfers data accurately in real time with the combination of tele- communications network and Internet; then finally it does smart processing that analyzes and processes the mass data and information to smart control things by using smart computing techniques such as cloud computing, fuzzy

recognition. The staff uses the mobile client PAMS in order to post real-time data of the daily work done and other important updates on the growth of the plants. Then PAMS analyzes the data and gives suggestions to the staff about what to do at the next stage. This model has helped the farm monitor reduce a lot of time monitoring the staff worker and the plant growing information. Furthermore, due to the right planting methods, the plants grew better than before (Mat et al., 2018) (Figure 6).

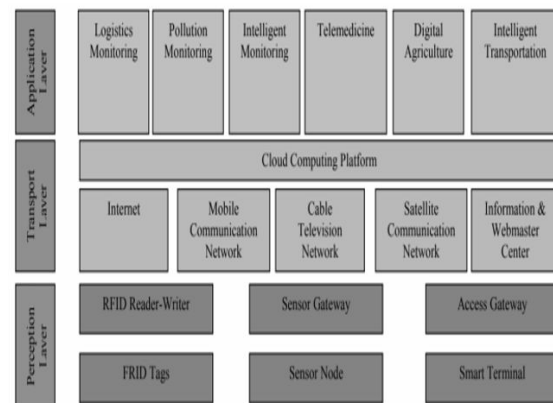

Source: Own processing

Figure 6. Architecture diagram of proposed model of PAMS using cloud computing.

Nandyala and Kim (2016) discussed the various technologies using green cloud computing and IoT. It also talks about the reduction in the consumption of energy when using Cloud Computing and IoT combination in agriculture. Additionally, this paper also presents a Green IoT Agriculture and Healthcare Application (GAHA) using a sensor-cloud integration model.

Sensor-cloud computing is considered to be one of the upcoming technologies to be used to effectively monitor agriculture. Sensor-Cloud is a new way for Cloud Computing which uses the sensors to gather data and communicate this gathered sensor data to a cloud infrastructure for analysis and effective handling of the collected data.

Sensor Cloud plays a vital role in provisioning the Sensors as a service platform while also satisfying multiple requirements. This service is provided by using virtual sensors in a cloud platform. It is also highly cost-effective as it does not require a lot of maintenance (Figure 7).

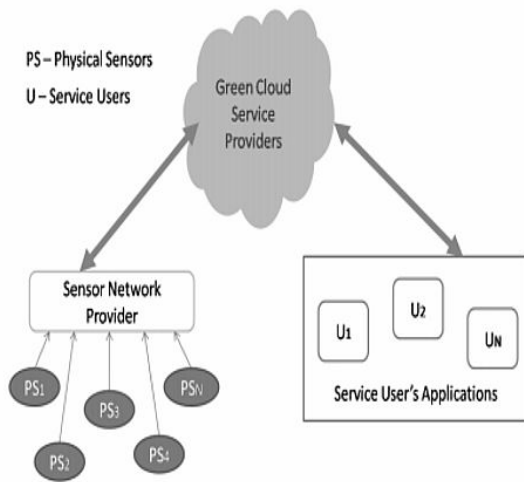

Source: Nandyala and Kim (2016)
Figure 7: GAHA Architecture.

Jaiganesh et al. (2017) outlined the uses of the Internet of Things combined with Cloud Computing in agriculture. It talks about using various kinds of sensors in order to track soil as well as the effective enabling technologies of IOT that can be used in order to optimize the farming process in order to get a better crop yield and help farmers.

Jain and Kumar (2020) used remote sensor properties to monitor the home conditions to decrease the overall costs of the agricultural process as well as to invigorate the productivity of growth normally. The proposed system suggests that the agriculture process is monitored by means of remote sensors. Precision Agriculture is clear on the boundaries of the product, geographically speaking. It makes use of a Wireless Sensor Network that needs an integrated unit of control. This WSN architecture is proposed because these sensors work very well considering the complexities of the unit controls. The sensors to be used for this collection of information must be functional, no lagging and legacy. Authentication will also be used to check credibility. There is a center area in these WSN which can include almost thousands of centers connected by means of sensors.

Centers constructed factoring in various constraints. These WSN can exhibit a simple star system and can be transformed to an advanced remote programming system.

Badhe et al. (2018) proposed systems of IOT use ZigBEE, GPS or GSM to transmit the information collected by means of soil monitoring. This method however, has been proven to not be very reliable and so a new method. This proposed method aims

to conquer the problem of meandering by means of a sensor based application that is remote and checks the soil. This is to be used to measure the vital parameters of soil like temperature, moisture as well as light sensors. Information collected via these sensors is communicated to a Thing Speak Application which makes use of the popular WiFi protocol. An MCP3204 Analog to Digital converter is used so that the raspberry pi can be an interface.

In this proposed system, each sensor is to be connected to this MCP3204 unit separately. The information gathered is sent to the cloud application, where it will be processed using some tools. Based on the results of which we can make appropriate agricultural decisions which will have a positive effect on the crop yield. ThingSpeak is highly recommended for this process as it uses the HTTP and MQTT protocol to receive data from the sensors. Since this MQTT protocol is lightweight, it can be used with ease even in case of some problems. Raspberry Pi is used due to its low cost and ease of use, especially on a Linux server. It also allows for multiple sensors to be connected to it simultaneously (Figure 8).

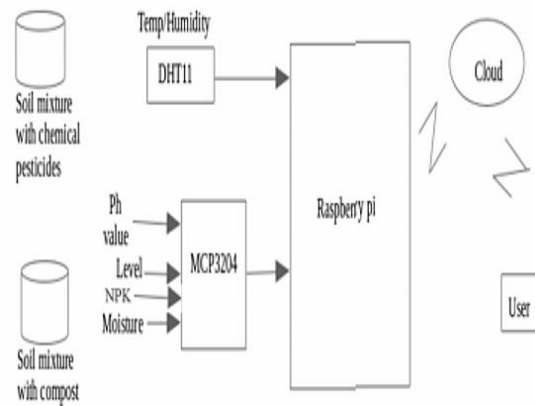

Source: Own processing
Figure 8: Smart Soil Nutrition Prediction Model.

Surai et al. (2018) used sensor networking based on multi nodes connectivity while involving good communication with the end users. This way IOT helps with implementing the networking between two objects that are physically present.

This proposed SSNP - Smart Soil Nutrition Prediction system would initially collect information about the soil. The information collected such as moisture, decision, etc. must be communicated to the end user by means of a wireless connection, so that remote users can also participate. These types of sensor networks consist of multiple nodes.

Each of these individual nodes will sense the outside environment as well as perform computation and collect data. Also, Sensor networks must also be deployed in a scattered manner in this region. By means of these wireless sensor networks, one can incorporate global warming into the soil monitoring process. Based on decisions made, the farmers can take the appropriate measures to ensure a good harvest.

Balan and Tech (2017) described sensors on a board to reduce the decoupling effect and relay being a part of the aforementioned board while also integrating noise (Balan and Tech, 2017). This type of system is to be produced due to a heavy load consumption. Proposed system is an AVR based sensor node that is wireless.

It has the highlights of ceaseless checking of certain boundaries that are indicated, has a simple deployment procedure and increments the lifetime of the batteries utilized. The IOT used for this proposed system is established using an ESP8266 module which helps in data transmission from remote location in the farm to the user. Sensor node contains various kinds of sensors which help to monitor the values of the soil moisture content. Power of downpour, current consumed by the engine by which dry run conditions and over stacked state of the engine can be determined. It also provides accurate details about the consumption of motors. Since most farms are away from technology, it is difficult to calculate any motor fluctuations which can cause motor damage. The AVR controller is used due to its low power consumption as compared to any other microcontroller.

Suma et al. (2017) proposed system the use of many features like GPS based monitoring that is controlled remotely, sensing of temperature, sensing of moisture, scaring of intruders, security, leaf moisture as well as proper irrigation facilities. It makes use of a WSN for collecting important/relevant data about the key properties of soil needed for crops and various other environmental factors that play a key role in farming. Multiple sensors are deployed in different fields around the farm so as to get a good report of the usual area. The above mentioned parameters are controlled by means of a remote device or through internet services and the operations performed are done by interfacing the various sensors, a camera with a microcontroller as well as WiFi. The PIC microcontroller is used as it is convenient to use and programming it is easy. This method also makes use of an EEPROM which stores the data about transmitter codes and receives the data related to frequency. GSM module can act

like a handphone, it can send as well as receive messages. At commands are used to send these messages. It has a reverse voltage based protection and operates in the voltage range of 900-1800 MHz. Soil moisture sensor works on the principle of an open and short circuit. For temperature an LM35 sensor is used with maximum output 5V. For every variation in temperature by 1 degree celsius its output increases by a quantity of 10 mV.

Rao and Sridhar (2018) proposed a raspberry pi based programmed irrigation system framework. This system will help to deliver modernization to the current farming system which will play a significant role in the development of crops especially in areas where the consumption of the resource water is low. This will speed up the process of farming and not to mention, significantly reduce the time spent by farmers on their fields. The management of the water system should be developed with a low complexity for circuits used. In the system proposed by them, the sensors will be placed in the field and give information about the amount of water required by the fields.

The above mentioned system makes use of two kinds of sensors: one to check the humidity and temperature of soil in the fields and another to measure the humidity and another to get the duration of daytime i.e, the time that the sun shines on the field. This system has an advantage because it uses the system of precision agriculture by integrating cloud computing to perform analysis to determine the amount of water to be used in order to ensure a good harvest. This method makes use of a Raspberry Pi microcontroller, which has a high speed. Pi3 works on a quad core 64-bit processing unit with Wifi and Bluetooth. RAM is 1GB.

Monitoring the external environmental factors is not the only thing important for automating the farming process. The system proposed by Vineela et al. (2018) to find a way to develop an automated system of agriculture using the relevant principles of IOT and hand this system to the farmers. Thing Speak will also be used to deploy this system so that it can be accessed remotely. Since this system will be developed as a low cost and efficient network of wireless sensors (Vineela et al., 2018). Raspberry Pi microcontroller is used in this proposed method as well. This method also incorporates a DHT 11 Sensor for temperature and humidity sensing. Output from this sensor is given directly to the data pin. The only disadvantage is, that a sensor can fresh data only in 2 second intervals. A relay is

a switch that is operated electrically, it is essential to this setup as the circuit needs to be controlled by means of a low powered signal (Figure 9).

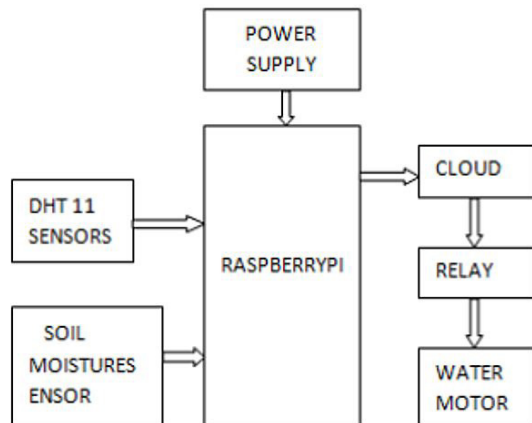

Source: Own processing

Figure 9: Block diagram of the proposed system.

Channe et al. (2015) proposed a smart agriculture system, this has been developed using advanced technologies like: Cloud Computing, Big Data analysis, sophisticated sensors and Mobile Computing (Channe et al., 2015). The vendors and farmers must be registered on the cloud module through the mobile application. The data collected from this mobile application will be sent to the cloud for analysis. Since the data collected is of large volume, big data analysis will be done to get relevant inferences from collected data. Analysis will be done in order to make decisions for the farmer like, appropriate fertilizer and its quantity, best method of crop rotation, as well as demand forecasting to find out the in-demand crops in the relevant markets.

The sensor kit is a low cost kit that is also portable. This is an IOT enabled device that has been incorporated with a memory processing capability. A GPS sensor is also included in order to detect the location data. Soil attribute sensors are also included to detect the amount of nutrients present in the soil (pH, Nitrate, Potassium, Phosphorus sensors).

The total populace is anticipated to be about 9.7 billion in the year 2050, as thus there will be incredible demand for food. This issue coupled alongside the reducing common assets, the arable land and unpredictable climate conditions make food security a huge issue for most nations around the globe. The world is beginning to use IoT along with data analytics in order to address the high demand for food in the upcoming years (Turgut and Boloni, 2017).

Materials and methods

Problem description: The farmers in our country face continuous struggles in earning their daily bread. The issues listed are inaccessibility to good quality seeds, absence of present day advances and equipment, poor irrigation system, managing middlemen to begin with. Due to these, the farmers face severe losses and aren't paid in proportion to all the hard work they put in. With our proposed solution, we aim to minimize losses, prevent excessive labor work, save energy and the cost of travel by providing farmers a clear understanding on the soil nutrition content using diffuse reflectance infrared spectroscopy.

Smart Soil Nutrition Prediction model

The proposed framework utilized the proven Support Vector Regression and Tikhonov Regularization method as its core algorithms. A version of SVM used in regression was proposed by (Drucker et al., 1997) this method is known as the support-vector regression (SVR).

The model is produced by support vector classification (SVC). It totally relies upon the subset of training data, since the cost function so as to assemble the model doesn't consider the training focuses that lie past the edge. Also, the model created by SVR relies just upon the subset of training data. This is on the grounds that the cost function so as to assemble the model disregards training data that lies near the model forecast. Another version of SVM known as the least-squares support-vector machine (LS-SVM) was proposed by Suykens and Vandewalle (1999).

Tikhonov regularization, is known as ridge regression and is utilized to decrease the issue of multicollinearity that happens in linear regression. This is a typical event in models with enormous quantities of parameters (Kennedy, 2003). The method provides improved efficiency in problems that include parameter estimation in exchange for a tolerable amount of bias (Gruber and Marvin, 1998). Also, various machine learning models are widely used for weather monitoring in short term rainfall prediction (Sudha and Subbu, 2017). Also statistical models are applied (Sudha, 2017). Medical disease diagnosis, agro decision support and in various interdisciplinary domains IoT and machine learning methods are applied nowadays (Sudha and Valarmathi, 2014; 2016). As a recent trend hybrid machine learning models

are applied in precipitation forecasting (Sudha and Valarmathi, 2015).

Process flow

We collect the data using multiple IR sensors to implement Diffuse Reflectance Infrared Spectroscopy. This is relayed using Arduino through the Zigbee protocol. The huge amount of collected data can be used to predict the values of soil nutrition for Calcium, Phosphorus, Organic Content, pH and Sand content. This will give an insight about the quality of the soil and the predicted crop yield for that area.

Experimental deployment

The proposed model will be a Level - 4 IoT System. A Level-4 IoT system is one which makes use of multiple nodes in order to perform local analysis. The information obtained from these sensors is stored. These subscribe and receive information that is collected in the cloud by means of the various IoT devices used. Level-4 IoT systems are characterized by their usability in solutions that require the use of multiple nodes and where the volume of data collected by these sensors is big.

Furthermore, the requirements of the solution are computationally intensive. The proposed solution consists of multiple nodes that monitor the soil at various areas.

Infrared sensing is utilized in a wide scope of uses including discovery, investigation: food safety, fire detection, fuel analysis, etc. Recently, they have been used for spectrometry and have facilitated as truly portable analyzers. An IR sensor could be active (emitter and detector) or passive (detector). The solution focuses on using passive IR sensors which will not have an influence over the samples or the environment around them.

Most IR sensors integrate with a microcontroller and in addition, a lens could be placed near the sensor that enables it to focus on some specific frequencies. Since all the soil samples transmit some type of radiation that normally lies in the infrared range and various materials retain particular frequencies of infrared energy, IR sensors will be used to analyse the components of the soil and identify the properties accordingly.

The advantages of utilizing the IR sensor for spectroscopy incorporate its capacity to catch an immense measure of information from the sample in detail that would help in deciding the sample structure and the fixation alongside the presence of added substances or contaminants.

Arduino the microcontroller used to support the IR sensor. The communication protocol used for this proposed system is the popular Zigbee protocol. Zigbee is a low range and low power IEEE 802.15.4 physical radio specification. It specializes in low power IoT devices, which is perfect for farmers as they can operate it using batteries. It works in permit-free groups including 868 MHz, 900 MHz and 2.4 GHz.. This protocol allows the IoT devices to communicate in many kinds of network topologies. It works especially well for a mesh topology as failure of one node does not result in failure of the entire network.

Results and discussion

After data preprocessing and plotting to understand the values in the dataset, we apply the above mentioned algorithms in order to predict the values of the five contents mentioned before.

Intent of this research is to predict the mean column wise root mean squared error metric in order to evaluate the model that we are training. We use the grid search function on the training dataset and save the best model. Gridsearch is a thorough search over determined parameter esteems for an assessor. Important members of this function are fit and predict. GridSearchCV implements a “fit” and a “score” method.

This implementation also makes use of the parameters: “predict”, “predict_proba”, “decision_function”, “transform” and “inverse_transform”. These parameters are implemented in the estimator that has been used. These parameters of the estimator are then used to apply these methods. These are further optimized by means of a cross-validated grid-search over the parameter grid. We then shuffle the dataset and split it into training and testing data.

We then apply the algorithms: Regression based on SVM (SVR) and Ridge Regression. Model trained is saved using the pickle module which is the standard way of serializing objects in python. This activity is utilized to serialize the AI calculation and use it to make any new predictions.

Models used as an input for search grid. Search grid generates all the possible combinations of the parameters. Then K-fold cross validation is performed on top of the training set with each of the previously generated combinations. It then returns the best model, which is then saved (Figure 10).

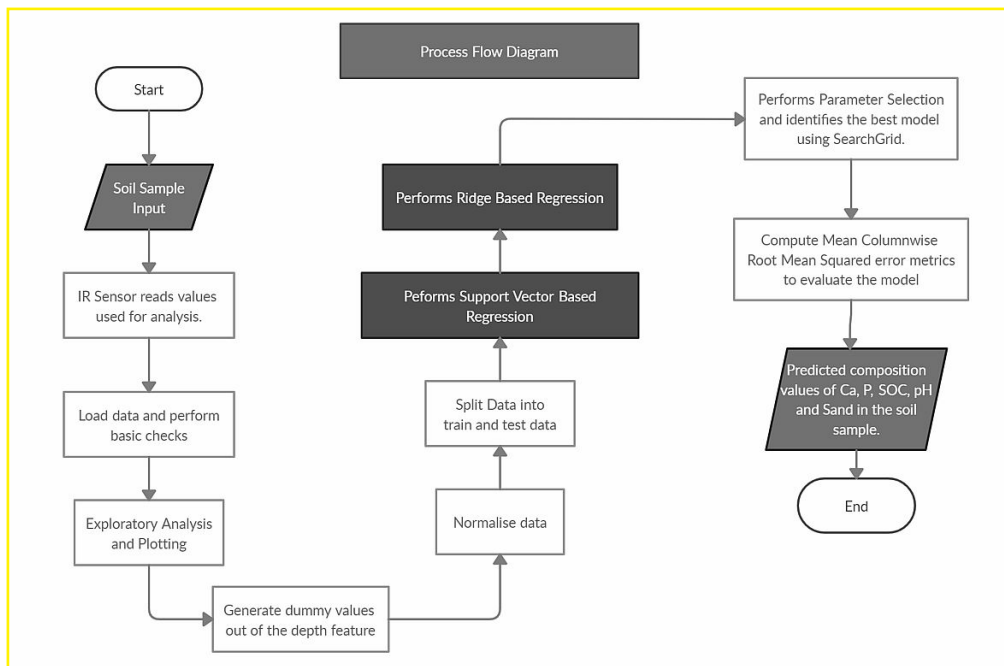

Source: Own processing

Figure 10: Smart soil nutrition prediction using IoT – experimental framework.

In the data frame considered, the number of features are actually higher than the number of entries. So proper algorithms must be implemented in order to handle the data as it is prone to overfitting. So we use simple regression models. We apply search grid to perform parameter selection.

```

=====
Ca elasticnet
=====
Fitting 5 folds for each of 20 candidates, totalling 100 fits
[mean: 0.89321, std: 0.05287, params: {'alpha': 0.01, 'l1_ratio': 0.1},
mean: 0.89176, std: 0.05748, params: {'alpha': 0.001, 'l1_ratio': 1},
mean: 0.88617, std: 0.06046, params: {'alpha': 0.01, 'l1_ratio': 0.01},
mean: 0.88480, std: 0.06309, params: {'alpha': 0.01, 'l1_ratio': 0.001},
mean: 0.88480, std: 0.06309, params: {'alpha': 0.01, 'l1_ratio': 0.001},
mean: 0.88300, std: 0.04493, params: {'alpha': 0.1, 'l1_ratio': 0.001},
mean: 0.88300, std: 0.04493, params: {'alpha': 0.1, 'l1_ratio': 0.001},
mean: 0.88095, std: 0.04489, params: {'alpha': 0.1, 'l1_ratio': 0.01},
mean: 0.87474, std: 0.08145, params: {'alpha': 0.001, 'l1_ratio': 0.1},
mean: 0.86833, std: 0.08413, params: {'alpha': 0.001, 'l1_ratio': 0.01},
mean: 0.86751, std: 0.08444, params: {'alpha': 0.001, 'l1_ratio': 0.001},
mean: 0.86751, std: 0.08444, params: {'alpha': 0.001, 'l1_ratio': 0.001},
mean: 0.86385, std: 0.05855, params: {'alpha': 0.01, 'l1_ratio': 1},
mean: 0.85118, std: 0.04948, params: {'alpha': 0.1, 'l1_ratio': 0.1},
mean: 0.84829, std: 0.04135, params: {'alpha': 1, 'l1_ratio': 0.001},
mean: 0.84829, std: 0.04135, params: {'alpha': 1, 'l1_ratio': 0.001},
mean: 0.82499, std: 0.04154, params: {'alpha': 1, 'l1_ratio': 0.01},
mean: 0.64924, std: 0.05378, params: {'alpha': 0.1, 'l1_ratio': 1},
mean: 0.59346, std: 0.05040, params: {'alpha': 1, 'l1_ratio': 0.1},
    
```

Source: Own processing

Figure 11: Log files of model training showing the target variables and their mean values.

Accordingly log files (Figure 11) are made

for the other 4 parameters that are to be predicted as well. Based on the results of those log files we come to the conclusion that: For the values of Ca, P, Soil Organic Content and Sand, Support Vector Regression gives the highest accuracy whereas for pH value, Ridge Regression gives the highest accuracy.

On performing a test on the test set based on the parameters and algorithms mentioned above we get value of MCRMSE as 0.410190847722

MCRMSE or mean column wise root mean squared error is defined as:

$$MCRMSE = \frac{1}{5} \sum_{j=1}^5 \sqrt{\frac{1}{n} \sum_{i=1}^n (y_{ij} - \hat{y}_{ij})^2}$$

where y and y^{\wedge} represent the actual and predicted values respectively.

Conclusion

This research focused on assessing the adoptability of various smart solutions using IoT in agriculture. This work explored the benefits of IoT and Data analytics and propose a model based on the same. The experimental results shown that Ridge Regression and Support Vector Regression attained maximum accuracy in predicting the soil nutrition value. On performing analysis on the data recorded by the IR sensor, the amount of Calcium,

Phosphorus, Sand, pH and organic content in the soil sample were predicted. This would enable the farmer to understand the kind of crops to grow

for maximum profit from the produce. It would enhance the operational efficiency and reduce the setup costs.

Corresponding authors

Sudha Mohankumar, Associate Professor

School of Information Technology and Engineering, Vellore Institute of Technology

Vellore Campus, Tiruvalam Rd, Katpadi, Vellore, Tamil Nadu 632014, India

E-mail: E-mail: msudha@vit.ac.in

References

- [1] Badhe, A., Kharadkar, S., Ware, R., Kamble, P. and Chavan, S. (2018) "IOT based smart agriculture and soil nutrient detection system", *International Journal on Future Revolution in Computer Science and Communication Engineering*, Vol. 4, No. 4, pp. 774-777. ISSN 2454-4248.
- [2] Balan, B. and Tech, M. (2017) "Sensor based smart agriculture using IOT", *International Journal of MC Square Scientific Research*, Vol. 9, No. 2. ISSN 0975-0932.
- [3] Drucker, H., Burges, Ch. J. C., Kaufman, L., Smola, A. and Vapnik, V. (1997) "Support Vector Regression Machines", *Advances in Neural Information Processing Systems*, NIPS 1996, pp. 155-161. ISSN 10495258.
- [4] Elijah, O., Rahman, T. A., Orikumhi, I., Leow, C. Y. and Hindia, M. N. (2018) "An overview of Internet of Things (IoT) and data analytics in agriculture: Benefits and challenges", *IEEE Internet of Things Journal*, Vol. 5, No. 5, pp. 3758-3773. ISSN 2327-4662. DOI 10.1109/JIOT.2018.2844296.
- [5] Gayatri, M. K., Jayasakthi, J. and Mala, G. A. (2015) "Providing Smart Agricultural solutions to farmers for better yielding using IoT", *IEEE Technological Innovation in ICT for Agriculture and Rural Development (TIAR)*, pp. 40-43. DOI 10.1109/TIAR.2015.7358528.
- [6] Gruber, M. (1998) *Improving Efficiency by Shrinkage: The James–Stein and Ridge Regression Estimators*, Boca Raton: CRC Press, 648 p. ISBN 0-8247-0156-9.
- [7] Channe, H., Kothari, S. and Kadam, D. (2015) "Multidisciplinary model for smart agriculture using internet-of-things (IoT), sensors, cloud-computing, mobile-computing and big-data analysis", *International Journal for Computer Technology and Applications*, Vol. 6, No. 3, pp. 374-382. ISSN 2229-6093.
- [8] Jaiganesh, S., Gunaseelan, K. and Ellappan, V. (2017) "IOT agriculture to improve food and Farming Technology", In: *2017 Conference on Emerging Devices and Smart Systems (ICEDSS) IEEE*, pp. 260-266. ISBN 9781509055562. DOI 10.1109/ICEDSS.2017.8073690.
- [9] Jain, A. and Kumar, A. (2020) "Smart Agriculture Monitoring System Using IOT", *International Journal for Research in Applied Science and Engineering Technology*, Vol. 8, No. 7, pp. 366-372. ISSN 2321-9653. DOI 10.22214/ijraset.2020.7060.
- [10] Jat, D. S., Limbo, A. S. and Singh, C. (2019) "Internet of things for automation in smart agriculture: a technical review", In: *Smart Farming Technologies for Sustainable Agricultural Development*, pp. 93-105, IGI Global. ISSN 2326-9162. DOI 10.4018/978-1-5225-5909-2.ch005.
- [11] Kennedy, P. (2003) *A Guide to Econometrics*, The MIT Press. pp. 205-206. ISBN 0-262-61183-X.
- [12] Lakhwani, K., Gianey, H., Agarwal, N. and Gupta, S. (2019) "Development of IoT for smart agriculture a review", In: *Emerging Trends in Expert Applications and Security*, pp. 425-432. Springer, ISBN-13. 978-9811322846.
- [13] Mat, I., Kassim, M. R. M., Harun, A. N. and Yusoff, I. M. (2018) "Smart agriculture using Internet of Things", In: *2018 IEEE Conference on Open Systems (ICOS)*, pp. 54-59. ISBN 978-1-5386-6666-1.

- [14] Nandyala, Ch. S. and Kim, H.-K. (2016) "Green IoT agriculture and healthcare application (GAHA)", *International Journal of Smart Home*, Vol. 10, No. 4, pp. 289-300. ISSN 1975-4094. DOI 10.14257/ijsh.2016.10.4.26.
- [15] Patil, K. A. and Kale, N. R. (2016) "A model for smart agriculture using IoT", *International Conference on Global Trends in Signal Processing, Information Computing and Communication (ICGTSPICC)*, pp. 543-545. ISBN 978-1-5090-0468-3. DOI 10.1109/ICGTSPICC.2016.7955360.
- [16] Prathibha, S. R., Hongal, A. and Jyothi, M. P. (2017) "IoT based monitoring system in smart agriculture", *International Conference on Recent Advances in Electronics and Communication Technology (ICRAECT)*, pp. 81-84. ISBN 9781509067022. DOI 10.1109/ICRAECT.2017.52.
- [17] Rao, R. N. and Sridhar, B. (2018) "IoT based smart crop-field monitoring and automation irrigation system", *IEEE, 2018 International Conference on Inventive Systems and Control (ICISC)*, pp. 478-483. ISBN 1538608073. DOI 10.1109/ICISC.2018.8399118.
- [18] Salam, A., and Shah, S. (2019) "Internet of things in smart agriculture: Enabling Technologies", *IEEE Fifth World Forum on Internet of Things (WF-IoT)*, pp. 692-695. ISBN 9781538649800.
- [19] Surai, S., Kundu, R., Ghosh, R. and Bid, G. (2018) "An IOT based smart agriculture system with soil moisture sensor", *Journal of Innovative Research*, Vol. 1, No. 1, pp. 39-42. ISSN 2349-6002.
- [20] Suma, N., Samson, S. R., Saranya, S., Shanmugapriya, G. and Subhashri, R. (2017) "IOT based smart agriculture monitoring system", *International Journal on Recent and Innovation Trends in Computing and Communication*, Vol. 5, No. 2, pp.177-181. ISSN 2321-8169. DOI 10.17762/ijritcc.v5i2.193.
- [21] Sudha, M. (2017) "Intelligent decision support system based on rough set and fuzzy logic approach for efficacious precipitation forecast", *Decision Science Letters*, Vol. 6, pp. 96-105. ISSN 19295804. DOI 10.5267/j.dsl.2016.6.002.
- [22] Sudha, M. and Subbu, K. (2017) "Statistical Feature Ranking and Fuzzy Supervised Learning Approach in Modeling Regional Rainfall Prediction Systems", *AGRIS on-line Papers in Economics and Informatics*, Vol. 9, No. 2, pp. 117-126. ISSN 1804-1930. DOI 10.7160/aol.2017.090210.
- [23] Sudha, M. and Valarmathi, B. (2014) "Rainfall forecast analysis using rough set attribute reduction and methods", *AGRIS on-line Papers in Economics and Informatics*, Vol. 6, No. 4, pp. 145-154. ISSN 18041930.
- [24] Sudha, M. and Valarmathi, B. (2015) "Impact of Hybrid Intelligent Computing in Identifying Constructive Weather Parameters for Modeling Effective Rainfall Prediction", *AGRIS on-line Papers in Economics and Informatics*, Vol. 7, No. 4, pp. 151 - 160. ISSN 1804-1930.
- [25] Sudha, M. and Valarmathi, B. (2016) "Identification of effective features and classifiers for short term rainfall prediction using rough set based maximum frequency weighted feature reduction technique", *Journal of Computing and Information Technology*, Vol. 24, No. 2, pp. 181-194. ISSN 1330-1136.
- [26] Suykens, J. A. and Vandewalle, J. (1999) "Least Squares Support Vector Machine Classifiers", *Neural Processing Letters*, Vol. 9, No. 3, pp. 293-300. ISSN 1573-773X.
- [27] Turgut, D. and Boloni, L. (2017) "Value of information and cost of privacy in the internet of things", *IEEE Communications Magazine*, Vol. 5, No. 9, pp. 62-66. ISSN 1636804. DOI 10.1109/MCOM.2017.1600625.
- [28] Vineela, T., Naga Harini, J., Kiranmai, C., Harshitha, G. and Adi Lakshmi, B. (2018) "IoT based agriculture monitoring and smart irrigation system using raspberry Pi", *International Research Journal of Engineering and Technology*, Vol. 5, pp.1417-1420. ISSN 2395-0056.
- [29] Ye, J., Chen, B., Liu, Q. and Fang, Y. (2013) "A precision agriculture management system based on Internet of Things and WebGIS", *IEEE 21st International Conference on Geoinformatics*, pp. 1-5. ISBN 9781467362283. DOI 10.1109/Geoinformatics.2013.6626173.
- [30] Zhao, J., Zhang, J., Feng, Y. and Li, J. (2010) "The study and application of the IOT technology in agriculture", *3rd IEEE International Conference on Computer Science and Information Technology, Chengdu*, Vol. 2, pp. 462-465. ISBN 9781424455409. DOI 10.1109/ICCSIT.2010.5565120.

The Role of Remote Sensing in Agriculture and Future Vision

Václav Šafář¹, Karel Charvát¹, Tomáš Mildorf², Patrick Crehan², David Kolitzus³, Tomas Orlickas⁴, Martynas Rimgaila⁴, Aušrius Kučinskas⁴, Salomėja Rybokienė⁴, Šárka Horáková¹ and Hana Kubičková²

¹ WIRELESSINFO, Litovel, Czech Republic

² Plan4all z.s., Horní Bříza, Czech Republic

³ GeoVille Information Systems and Data Processing GmbH, Innsbruck, Austria

⁴ Nacionalinė mokėjimo agentūra, Vilnius, Lithuania

Abstract

The sustainability of agriculture became one of the key priorities for policy frameworks at global and European levels. The global initiative of the United Nations that defined the Sustainable Development Goals and the European Green Deal. Use of remote sensing to achieve sustainable practices in the entire agriculture value chain can significantly contribute to fulfil the set goals by the policy frameworks. This paper analyses the stakeholders involved in agriculture including the agri-food, public, financial and food security sectors, and their needs. In situ and virtual workshops with relevant stakeholders including an online survey served as a primary source of input for the user requirements analysis and as a platform for feedback and discussion. As a result, a set of key documents including a white paper, a policy roadmap and a strategic research agenda were published. Recommendations for future utilisation of remote sensing in agriculture are described in this paper.

Keywords

Earth observation, agriculture, white paper, strategic research agenda, policy roadmap, technology watch, hackathon, webinars, questionnaires.

Šafář, V., Charvát, M., Mildorf, T., Crehan, P., Kolitzus, D., Orlickas, T., Rimgaila, M., Kučinskas, A., Rybokienė, S., Horáková, Š. and Kubičková, H. (2022) "The Role of Remote Sensing in Agriculture and Future Vision", *AGRIS on-line Papers in Economics and Informatics*, Vol. 14, No. 1, pp. 107-124. ISSN 1804-1930. DOI 10.7160/aol.2022.140109.

Introduction

The increasing economic, social and environmental needs of agriculture pose many challenges for the upcoming years. This topic of sustainable agriculture is closely related to the strategies of the United Nations and the European Union on sustainability. The United Nations adopted 17 Sustainable Development Goals in 2015 as part of the 2030 Agenda for Sustainable Development. The European Union presented in 2019 the European Green Deal - a roadmap to make the European economy sustainable (Campbell et al., 2018; Lampridi et al., 2019).

Agriculture comprises vital economic sectors producing food, agro-industrial feedstock, and energy and provides environmental services through managing soil, water, air, and biodiversity holistically. An overview of all these aspects is given in this publication (Baer and Birgé, 2018). Agriculture including forestry also contributes

to managing and reducing risks from natural disasters such as floods, droughts, landslides, and avalanches (Sivakumar, 2005; FAO, 2020). Farming with its close contact to nature provides the socio-economic infrastructure to maintain cultural heritage. Farmers are also conservers of forests, pastures, fallow lands, and their natural resources and, in turn, of the environment (Jedlička et al., 2019; Montañana et al., 2020; Navrozidis et al., 2019; Diacono et al., 2021). Agriculture today is a composite activity involving many actors and stakeholders in agri-food chains (FAO, 2017) that produce and provide food and agricultural commodities to consumers. In addition to farmers, there are farm input suppliers, processors, transporters, and market intermediaries each playing their roles to make these chains efficient (Horizon 2020 Work Programme, 2018-2020).

More than 10 years ago the FutureFarm project (Charvat and Gnip, 2009) recognized that

the agriculture sector is under a strong influence of several external drivers including climate change, demographics, energy cost, food quality and safety, policies, economical and financial instruments, sustainability, and public opinion. Interactions between different drivers influence the agri-production and the food market is then dependent on regulations and common policies.

Due to the complexity of sustainable agriculture we need to better understand all processes involved and build for each agriculture sector a new knowledge management system (Zhao et al., 2020). The main focus of paper is on the use of Earth observation, and particularly on Copernicus satellite data, in support of agriculture. This paper analyses the role of Earth observation (EO) as a knowledge management system for sustainable agriculture including its current gaps and limitations (Anderson et al., 2017; Whitcraft et al., 2015). The main focus is on Copernicus satellite data. Copernicus is a European asset for space-based monitoring of the Earth, consisting of a complex set of systems, which collect data from multiple sources: Earth observation (EO) satellites and in-situ sensors such as ground stations, airborne and sea-borne sensors. The data are processed providing users with reliable and up-to-date information through a set of services related to environmental and security issues. As it became clear, the key to unleash the huge potential of Copernicus is easy to access its data and information products. In this regard, the European Commission (EC) created the baseplate for establishing an Integrated Ground System (IGS) for Copernicus that will empower the user communities to have the maximum benefits from EO data and information (Annex 1 to the GA, Part B EO4AGRI). EO data needs to be augmented with local expertise and this means that a deep cooperation model needs to be incorporated.

The research in this paper was performed during the EO4Agri project funded by the H2020 programme. The main objective of this paper is to catalyse the evolution of the European capacity for improving operational agriculture monitoring from local to global levels based on information derived from Copernicus satellite observation data and through exploitation of associated geospatial and socio-economic information services.

Materials and methods chapter introduces the research methods used to gather and analyse gaps in exploitation of EO data for agriculture including the methodology for user requirements collection, stakeholder analysis, online survey and policy and implementation frameworks.

Results and discussion chapter presents the results in the form of a white paper and set of recommendations related to technology improvements, scientific priorities and organisation related issues.

Materials and methods

EO4Agri methodology for user requirements collection

The EO4Agri methodology was initially based on Foresight approach (Crehan and Harper, 2008). The goal was not to create new user requirements, but to make sense of the great number of requirements that have been created in the past via the efforts of projects funded by EU Framework Programmes such as H2020, ESA or ad-hoc projects and programmes funded by EU member states. Foresight is a strategic management tool, originally employed in the public sector as an aid in the design of research programmes. Nowadays, it is much more widely applied, not only in the public but in the private sector as well. Typically, a foresight exercise produces outputs such as vision statements, roadmaps and actions plans for implementation. In general, a foresight exercise involves:

- A systematic approach to generate knowledge about the future - insights about future Copernicus services and how these will benefit the four focus groups of the EO4Agri project, namely the agrifood, public, financial and food security sectors. These four groups are using services of technical providers including infrastructure providers, software providers and EO data analytics sector;
- A wide range of actors relevant to the domain of focus of the activity including decision-makers and domain experts, as well as enablers, beneficiaries and other stakeholders from the focus groups mentioned above. The purpose of their participation is to help them learn about the domain or focus of the activity, understand how change happens in that domain, contribute to the shaping of the evolution of that domain, and get ready to play a part in the implementation of recommendations that might emerge from the activity;

The outputs of the four focus groups were integrated into a set of key documents including a white paper, strategic research agenda (SRA), policy roadmap and a collaboration framework presented as results

in this paper. This set of documents should help to mobilise and structure support for the further development of Copernicus services with a view to accelerating the process of the common agriculture policy (CAP) reform, improving the livelihood of farmers in Europe and increasing Europe’s overall level of resilience and security of food systems in Europe (Crehan et al., 2019).

Stakeholder analysis

EO4Agri performed an analysis of the needs of different groups of stakeholders from the four focus areas including agri-food, public, financial and food security. These areas are connected with agriculture, not only on the level of production of agricultural products and food, but also on the level of developing policies for agriculture and financing (CAP payment system). The four focus groups include:

- Agri-food sector - agricultural producers, service providers, advisers, machinery, and food sectors that use data-intensive

services to improve their productivity in both agricultural production and business administration. The agri-food sector is composed of different players with different interests. These users can be subdivided into:

- A subgroup connected directly or indirectly with precision agriculture. This subgroup can include agricultural producers, service providers, advisers, machinery, and also the food sector. The relations between the involved stakeholder groups are depicted in Figure 1.
- A subgroup related to the analysis and prediction of the food market. Currently, customers of this information are mainly in the food industry. However, the importance of this information will grow in the future also for the primary sector concerning planning production. Figure 2 shows the relation of this group in relation

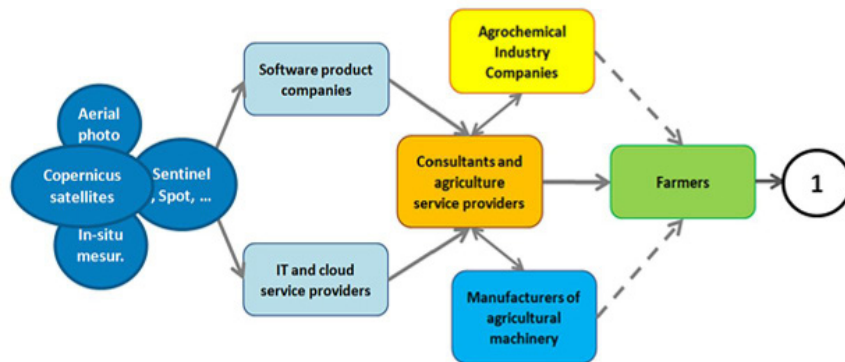

Source: Own processing.

Figure 1: data access and information services actors (EO4Agri - User Requirements and Gap Analysis in Different Sectors).

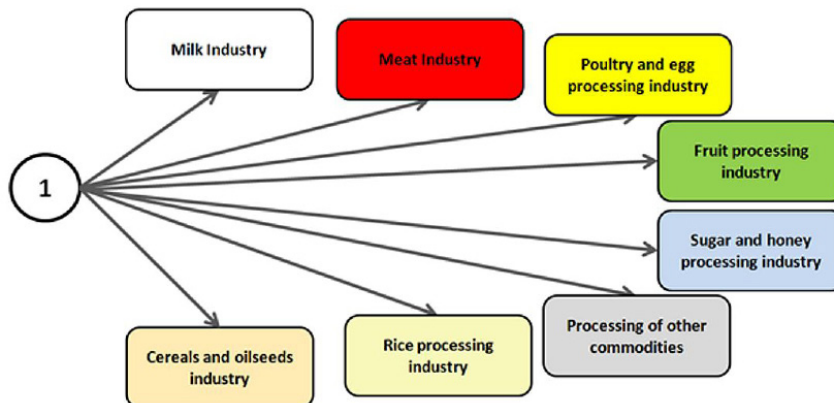

Source: Own processing.

Figure 2: Scheme of agro-industry sector and raw segments in the food industry (EO4Agri - User Requirements and Gap Analysis in Different Sectors).

to the previous group (Figure 1); Public sector organizations (and in particular national paying agencies responsible for the management of the agriculture subsidies) that use EO data as an input to agricultural policy formulation and for implementation of new farm subsidies payment systems based on monitoring (instead of inspection) and performance (instead of compliance).

- Agricultural finance institutions that provide the agri-food industry with credit and insurance services, as well as related services such as re-insurance and decision support services to commodities and derivatives traders.
- Organizations that support global food security, in particular donors involved in infrastructure and capacity building in third countries with security in food and nutrition. The activities of the donors can be related to other issues such as climate and the environment, and the management of scarce resources such as water, soil, and nitrate-based fertilizers. This group includes also local farm organizations, researchers, and the public sector in developing countries. The main incentive of this group should be to combine top-down and bottom-up approaches to solve the problem of food security.

In addition to the main four focus groups, the following stakeholder groups were identified:

- The growing industry of data service providers that transform raw data

and basic services provided by Copernicus into services adapted to the needs of the four main stakeholder groups mentioned above.

- The range of services that can be provided is in constant evolution thanks to the efforts of researchers and data entrepreneurs leveraging the latest knowledge and know-how in plant and animal sciences, environment and climate sciences, economic, social, and geophysical sciences as well as new and emerging domains of ICT based on the application of artificial intelligence, machine learning or data learning in big data analytics.

Policy framework, sustainable development goals, Green Deal and Destination Earths - new challenges

Policy frameworks for utilisation of EO in agriculture are mainly given by the UN Sustainable Development Goals (SDG) at the global scale and the European Green Deal initiative and Destination Earth strategy at the European level. From the research and implementation frameworks points of view, the Group on Earth Observations (GEO) Work Programme in the global scale, Horizon Europe, Digital Strategy for Europe and Space Strategy for Europe can be identified.

The UN SDGs are a universal call to action to end poverty, protect the planet and improve the lives and prospects of everyone, everywhere. 17 goals were adopted by all UN Member States in 2015, as part of the 2030 Agenda for Sustainable Development which set out a 15-year plan to achieve the goals (Figure 3).



Source: Own processing.

Figure 3: The UN Sustainable Development Goals (The Sustainable Development Agenda).

The UN SDGs (The Sustainable Development Agenda) were approved in May 2019 by the European Commission and many of them are directly addressed to agriculture, forestry and environment.

The European Green Deal (Annex to the Communication on the European Green Deal, 2019) is a package of European Commission’s measures announced in December 2019 that should ensure citizens and companies in European Union the transition to a more sustainable and greener economy by 2050. The Green Deal consists of a set of measures that enhances resource efficiency through the transition to a clean circular economy, prevents biodiversity loss and reduces pollution. These measures are related to the policy areas depicted in Figure 4.

Together with publishing the Green Deal, the Commission is adopting the EU industrial strategy Destination Earth (DestinE) to address the twin challenge of the green and the digital transformation. The goal is to use the potential of the digital transformation, to be a key enabler for reaching the Green Deal objectives (The European Green Deal, 2019). The Commission is planning to initiate a ‘GreenData4All’, with focus on reviewing the Directive establishing an Infrastructure for Spatial Information in the EU (INSPIRE and Combine it with the Access to Environment Information Directive). As part of this will be the ‘Destination Earth’ initiative.

A digital twin is a digital replica of a living or non-living physical entity. The digital twins created

in DestinE will give users access to high-quality information, services, models, scenarios, forecasts and visualisations (e.g., in climate modelling, weather forecasting and hurricane evolution). Digital twins are based on the integration of continuous observation, modelling and high performance simulation, resulting in highly accurate predictions of future developments.

DestinE will be implemented gradually over the next 7-10 years, starting in 2021. The operational core platform, the digital twins and services are scheduled to be developed as part of the Commission’s Digital Europe programme, whilst Horizon Europe will provide research and innovation opportunities that will support the further development of DestinE. Synergies with other EU programmes, such as the Space Programme, and related national initiatives will also be explored.

Common agriculture policy and Earth observation

The CAP is the largest and most promising area of Copernicus and Galileo data use in the public sector, with farming being one of the main economic sectors using such data. The overall objective for CAP period 2021-2027 is to move from the process of controlling agricultural activity compliance with the requirements to the increase of operational efficiency. For that, the Area Monitoring System (AMS) should be in place by 2024. AMS requires joining satellite observation data (e.g., from Copernicus) with GIS data originating from territorial Land Parcel Identification Systems (LPIS).



Source: The European Green Deal, 2019.

Figure 4: European Green Deal and key policy areas.

One of the AMS parts – Checks by Monitoring (CbM) component, based on satellite data and photos sent by farmers about the carried out agricultural activities – is in the process of implementation, but implementation is not as fast as it could be.

Each EU Member State and Paying Agency has to ensure that farmers rightfully receive subsidies for their good practices. The current practice is that these entities mainly perform on-farm checks (on a randomly selected and risk analysis-based sample of farmers), the so called on-the-spot checks, and farmers with poor performances in relation to their subsidies' requirements are subject to penalties which may include exclusion from participation in funding schemes and/or monetary fines. This system partly relies on Control with Remote Sensing (CwRS) with the use of EO data: Very High Resolution – VHR and High Resolution – HR (10-20 m) images, with the possibility to use the other available satellite data as complementary data source.

On-farm checks entail serious drawbacks. They provide only a “snapshot” verification of farmers' practices and the state of their farmland, taken at a specific moment in time; they are conducted only on a small sample of farmers (in the case of farmers applying for EU subsidies); they are time-consuming and their cost is significantly high (especially when there is a need for follow up on-farm inspections); and when performed with the support of remote sensing images at fixed time windows, they are not adequate for capturing most of the temporal agronomic practices and farming activities.

Aiming to solve the above-mentioned problems and to make the farm inspections a more efficient, transparent and flexible process, the CbM concept was introduced. CbM does not represent a standard on-the-spot checks (neither CwRS), but rather a different approach of Integrated Administration and Control System (IACS) mechanism. The ambition is to completely replace on-farm checks with the use of automated checks based on EO data which enable specific “snapshot” verification of sustainable agricultural practices, applying the same logic as in the field, but through a computer-assisted environment, or the continuous (through the year) monitoring of farmland.

CbM was introduced in 2017, and the new rules came into force in May 2018. Starting from 2018 (art. 40a of EC Regulation 809/2014) the CbM became part of IACS and there is now an option to carry out CbM on 100% of beneficiaries

for all eligibility requirements, using the Copernicus Sentinel satellite data, instead of checking 5% on the spot. This approach offers significant simplification and streamlining of IACS and should reduce the number of costly inspections in the field. Based on that all EU member states could use data from the EU's Copernicus Sentinel satellites and other EO data as evidence when checking farmers' fulfilment of requirements under the CAP for area-based payments (either direct payments to farmers or rural development support payments), as well as cross-compliance requirements, such as stubble burning. Other new forms of evidence such as geo-tagged photos, information from drones and relevant supporting documentation from farmers, such as seed labels, also are acceptable for the first time, as part of a broader shift towards a so-called ‘monitoring approach’ that will lead to a decrease in the number of on-farm checks. Visits to the field will be only necessary when the digital evidence is not sufficient to verify compliance.

Cooperation framework

In order to discuss our achievements with the broader community, EO4Agri was active in cooperation with international and European initiatives and projects. During the first year, EO4AGRI succeeded to meet most of the key players on the global and European scene. One of them is the Food and Agriculture Organization (FAO) as the main means of communication with the UN. The target of the discussion was on how EO can support global food and nutrition security and UN SDGs focused on agriculture. The cooperation with FAO was done mainly through common activity in the Agricultural Data Interest Group (IGAD) of the Research Data Alliance (RDA). EO4Agri established a contact with the Group on Earth Observations (GEO) mainly through cooperation with GEOGLAM. There was also an intensive cooperation with the Global Open Data for Agriculture and Nutrition (GODAN), where EO4Agri organised a number of meetings together with GODAN mainly on IGAD RDA meetings and also cooperated in the preparation and promotion of INSPIRE Hackathons. EO4Agri also organised a common workshop with GEOGLAM and GODAN for the GEO ministerial meeting in Canberra. The direction of the future cooperation activities with GODAN are mainly in promotion of Open Data and Capacity building. The standardisation of information in Agriculture, including EO is done through IGAD and OGC, where there is broad cooperation (Druml et al., 2020).

Analysis of previous recommendations and user requirements

One of the main tasks of the EO4Agri project was to gather recommendations from previous research projects and activities. More than 80 projects were analysed and 410 user requirements were identified and reduced to final 69 user requirements. Most analysed projects are from the Copernicus library of research projects listed in Appendix A (EO4Agri - Analysis of previous projects). The requirements were mapped to the stakeholder groups mentioned in the previous section. Requirements that are common to three or more stakeholder groups were labelled as gold requirements, overlapping requirements between two stakeholder groups were labelled as silver requirements and bronze requirements are those belonging to just one stakeholder group. The user requirements categorised as gold, silver and bronze requirements are presented in Appendix B (EO4Agri - User Requirements and Gap Analysis in Different Sectors).

Questionnaire analysis

An online questionnaire conducted by the EO4Agri project resulted in more than sixty responses that were analysed. The main results of the questionnaire include:

- 75% of respondents state that they are well acquainted with EO issues. This proportion is similar in all stakeholder groups;
- 80% of respondents who grow cereals are mainly interested in the effect of using EO information in the form of increased yield and profit and sustainability of their farming and businesses;
- 55% of respondents farm on less than 30 ha (of which 20% for less than 5 ha) and 35% farm on more than 250 ha;
- respondents see difficulties in interpreting remote sensing data and real-time unavailability of data as the main obstacles of more extensive use of EO in agriculture;
- 80% of respondents use data made available through public servers and the same number use multispectral data from Sentinel and LandSat satellites for their work at least once a week;
- RGB data is used by 40% of respondents;
- respondents consider the ground sample distance to be insufficient, when 32% of respondents require data with a ground sample distance (GSD) of less than 1 m

and another 42% of respondents require data with a GSD of less than 5 m. Only 10.5% of respondents are satisfied with the current GSD of Sentinel 2 satellites which is 10, 20 and 60 m depending on the native resolution of the different spectral bands;

- two thirds of respondents state that they buy data at a price of less than 5 euro per hectare. The same number of respondents indicates that the yield from hectares will rise by up to 20 euros thanks to EO information.

If we select only responses from the private sector, then their answers correspond to answers of other stakeholder groups with one exception. The exception is the requirement for a higher GSD which is only 50% compared to almost 90% of other stakeholder groups. A half of the respondents from the private sector are satisfied with what they work with (usually GSD = 10-30 m).

The statistical summary and responses are in Appendix C (EO4Agri - The statistical summary and response to the main user requirements).

Analysis of outputs from workshops, webinars and hackathons

The gap analysis and foresight activities started during the year 2019 and ran until January 2020. During this period EO4Agri organized four in situ meetings in order to identify gaps with the main stakeholders groups mentioned in Stakeholder analysis and provided foresight exercises to build a new vision of EO for agriculture for future periods. The gap analysis and future vision were discussed during the follow up in-situ events including the Nairobi INSPIRE Hackathon 2019, EO4Agri Stakeholder Workshop in Pilsen, GEO Week 2019 and the GEO Ministerial Summit in Canberra, November 19 OGC TC/PC Meetings - Toulouse, France 2019 and Prague Week on Big and Open Data and Innovation Hubs 2020.

The COVID 19 outbreak created an unprecedented and unpredictable situation that made it impossible to organize face-to-face conferences, workshops, seminars and hackathons. Therefore, all planned meetings and workshops were organized as fully virtual events. About ten virtual events were organised in order to validate the EO4Agri results.

During both in situ and virtual events new requirements for the agri-food and public sectors and data requirements were defined and become

part of the EO4Agri recommendations and future vision (Šafář et al., 2020), (Šafář et al., 2020), (Kubíčková et al., 2021).

Agri-Food Sector:

- To assess risks/threats to sensitive ecosystems like forests and wetlands. Forests and wetlands area known as contributors to food security particularly when sustainably used;
- accurate monitoring of crop phenology to aid the application of farm inputs like fertilizers, irrigation and farm management;
- crop growth scenarios under different weather events. Growth plan – a time interval when to start planting to maximize yield as possibilities are nitrogen plan – a time interval when to insert nitrogen fertilization to maximize its effect, Insect pests alert – alert when a risk of insect pest attack is high;
- prediction of disease susceptibility of crop using the temporal crop dynamics from Earth observation data. Using historical data of crop disease and connecting them with features extracted from Earth observation data for generating alert of probable crop disease;
- from the analysis of the agri-food sector, the main additional requirement is to support food traceability.

Data requirements:

- Used weather data and biomass to generate index-based services for Banking and insurance such as Weather and Yield;
- sampling plots from different agro-climatic zones and monitoring growth using Earth observation techniques together with ancillary data like weather data and biophysical data;
- sentinel 1 and 2 has a spatial resolution of 20 m (some bands have 10 m) so small farmers can be benefited by the products developed using images from these satellites;
- semantic data and metadata for the description of different types of data in order to assess their applicability to EO;
- requirement for implementation of OGC standards in all EO data services;

- more focus should be on time series analysis of EO data in short and also long time periods in order to better prepare new models and adopt AI tools for future scenarios;
- metadata models and views on metadata need to be updated in order to guarantee better monitoring of data life cycles to support Destination Earth.

Public sector:

- Assessment of hydrological flows through a combination of field observations and output from satellite image analysis workflows;
- augmenting weather and climate monitoring through the use of affordable in-situ weather sensors and remote sensed weather estimates;
- LandSat can particularly be used for awareness creation on issues like land degradation and land-use change and its influence on land health and the potential areas that can be used for farming;
- need to access very high-resolution data, which are mainly available as commercial services;
- gap filled time series of high-resolution EO data;
- detection of emergence and harvest data;
- even though the main driver for AMS is the cost savings, there are no real calculations of how much it will be saved - the cost of IACS increased over the years and AMS for sure will not decrease that cost (how to calculate?);
- calculation of how much use of the European Data and Information Access Services (DIAS) can save total cost;
- list of available and future Copernicus core services and their possible usage in AMS;
- data and predictions of the occurrence of voles and the system of protection against them;
- data and procedures for the protection of animals during haymaking;
- data and procedures for predicting grasshopper invasion;

- historical data for the needs of multitemporal studies;
 - data for the creation of 4D and 5D data models for agricultural production;
 - it is important to re-use previous financing and previously developed platforms from H2020 projects as building blocks for Destination Earth;
 - in order to reach the Sustainable Development Goals and European Green Deal goals, it is necessary to build public private partnership;
 - there is a need for additional multi-actor research across domains (agriculture, food, biodiversity, space, IT), which will help to use the full potential of Earth observation for agriculture.
- to deal with current issues (small parcels, complex subsidy system with few monitorable eligibility criteria, doubts about the future audits approach, lack of skills, funding, infrastructure, etc.);
 - to conduct a survey about usage of developed tools of International projects: it is still not clear how PA's are planning to test all the tools as well as Free and Open Source Software (FOSS), that are/will be developed through those international projects;
 - to organise a cycle of webinars about existing and future Copernicus Core service products: it is a need of learning how these products could be used for CAP (27 PA's out of 29 in 2020);
 - EC should be the main provider of all the needed algorithms for AMS (crop type, grass mowing detection, etc.);
 - production of centralized vegetation indices and provision of "Signals as a Services" (EEA and VA Industry). EEA has placed a contract for systematic production from Sentinel-2 of "High Resolution Vegetation Phenology & Productivity" (HR VPP) products (NDVI, LAI, FAPAR, seasonal trajectories, productivity parameters) for access via the CLMS; geographic coverage is EEA39. DG-AGRI, JRC and EEA should jointly assess the suitability of HR VPP and the possibility to steer production and data dissemination for CAP Monitoring purposes;
 - it should be made easy for Value-added Industry (e.g., Data Cube Service Providers) to integrate with the CLMS for implementing parcel-based signal and marker services based on HR VPP, if adequate;
 - necessity to define the minimum scope of CbM as a legal part of the Area Monitoring System (AMS): list of minimum requirements (measures, criteria) for setting CbM should be prepared. Current performance output indicators are not adapted to be moved to the new AMS. EU MS are overloaded with different requirements in different countries, which are not designed for direct monitoring with EO data, e.g., permanent crops rows mowing, etc., therefore there is an urgent need of simplification and reduction of their number;

Results and discussion

The white paper was the first presentation of the EO4Agri vision about the role of EO in agriculture. It was recognised that the increasing economic, social, and environmental needs of agriculture pose many challenges for upcoming years. This topic is closely related to the strategies of the UN SDGs and the European Green Deal on sustainability. The white paper stresses the importance of knowledge management for agriculture to help to solve new challenges in the agriculture sector. The white paper focuses on the definition of key problems, analysis data gaps, delivery platforms, analytical platforms, and final recommendations for future policies and financing. The document serves as an input for the Policy Roadmap and the Strategic Research Agenda.

As two main final results are:

- Policy roadmap - set of recommendations towards CAP reform;
- Strategic Research Agenda - list of priorities for future research activities in different programmes and initiatives.

Policy roadmap

The policy roadmap prepared set of recommendation for future update of Common Agriculture Policies to benefit better from Earth observation technologies:

- The current frequency of Sentinel data is sufficient, but the spatial resolution would still be preferred to be at 5 or even 1 meter;
- to prepare a horizontal action plan how

- developing a good practice knowledge database of controlling different requirements. The EC could take over this responsibility. The knowledge database should be shared among the EU MS;
- the EC should include a reference in its respective AMS regulation about conditionality: instructions on using satellite data related to conditionality (replacing cross-compliance) and remote sensing requirements, e.g., control of spreading manure; fallow; burning, etc;
- an overall EC leadership on conditionality (cross-compliance) and agri-environmental schemes is still missing;
- more suitable EU legislation for using of Copernicus Sentinels: higher threshold of minimum eligible parcel for support (when CbM applies); simplification of Greening, Agri-environmental and other CAP non-monitorable requirements (e.g., specific plants for crop diversification, two different crops for catch crops);
- it is necessary to update the respective EC Regulations to lower the requirements for MS for Monitoring approach (e.g., raise level of traffic light threshold (EUR 50/250);
- it is necessary to improve EC standards for “GeoTag” tools, aiming to increase harmonization among different countries;
- geo-tagged photos & in-situ data: the initiatives by GSA and DG-AGRI for developing tools (e.g., FAST) for helping farmers to collect and communicate in-situ information with the Paying Agencies are considered important and shall be pursued towards “de-facto” standard practices;
- “Planet Scope time-stacks data” are generated for parcels which cannot be monitored by Sentinel due to geometric resolution. There shall be guidelines on how to use VHR EO data and the EC shall continue to support demonstration projects and communicate lessons learnt to the Paying Agency’s community. Furthermore, the information shall be made widely available on how Paying Agency systems can integrate with VHR EO data dissemination services (via API);
- it is necessary to educate the general public and farmers as end users of EO to increase the proactive use of products and data from EO;
- centralised CARD4L production (DIAS): JRC (via ESA contract mechanisms) has been tasking the four industrial DIAS’s to demonstrate large-scale production of Sentinel-1 backscatter and coherence as well as Sentinel-2 L2A;
- DIAS individually reported to be ready as presented to Expert Group for Direct Payments (EGDP) during the info event on 24 January 2020;
- follow up by the EC DG AGRI and JRC with Paying Agencies in promoting these DIAS production capabilities further and of a higher technical level.

Strategic Research Agenda

The EO4Agri Strategic Research Agenda (SRA) (Šafář et al., 2020). is a set of recommendations for future research activities in the area of Earth observation for agriculture. It is one of the key deliverables in EO4Agri and there are two objectives of this deliverable:

- To prepare an input for the European Commission, European Space Agency and Group on Earth Observations (GEO) how to build future research and innovation activities in this domain;
- to help the research and innovation community to discover potential topics for their future research in the frame of the current financial mechanisms and initiatives.

The EO4Agri SRA is based on a synthesis of the current requirements coming from political and research frameworks, and gap and technological analysis provided by EO4Agri. The EO4Agri SRA is a list of recommendations for future activities in the GEO, Horizon Europe) and the Digital Europe programmes. It is not a revision of these programmes, but additional recommendations or tasks, which are important for future revisions of these programmes. Most of the gaps identified by EO4Agri are well addressed by the current programmes. In some cases, revisions of these programmes will be inevitable.

Figure 5 depicts the approach for defining the SRA.

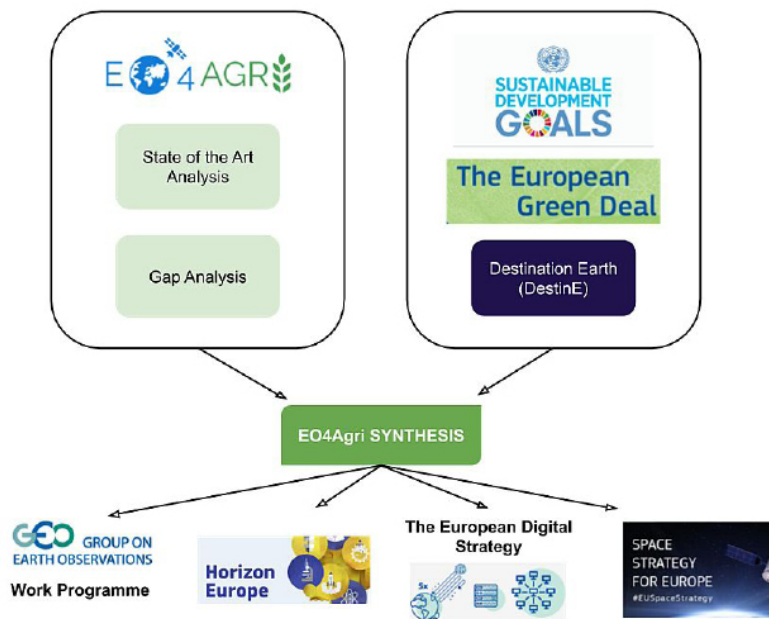

Source: Šafář et al., 2020.

Figure 5: Basic schema of the SRA definition approach.

Final recommendations

On the basis of previous analysis, the EO4Agri prepared three sets of recommendations, for future better utilisation of Earth Observation Technologies in Agriculture. It could be divided as:

- Technological recommendations
- Future scientific priorities
- Organisation recommendations

Technology recommendations

Overall, a wide range of agricultural applications supported by Copernicus data and services already exist including a long list of success stories. However, there is still a large potential for improvements. Concrete short term and long term actions were identified including the agenda for future research (Kolitzus, 2020).

Technical Aspects

For many applications in agriculture the spatial and temporal resolutions of the Sentinel missions are not sufficient, and the upcoming open satellite missions will not close this gap entirely. Data fusion with commercial data providers seems absolutely necessary and two potential Copernicus products with huge added value are possible:

- Provision of a gap-filled time series of vegetational and biophysical parameters (with S-1/S-2/S-3 and commercial VHR/HHR data) going towards daily observation;

- provision of super-resolution approaches to increase the spatial resolution of the Sentinel missions using commercial VHR/HHR data as calibration and validation points.

A major benefit would also be to integrate field polygons as open government data and directly allow analysis on field level and lifting the burden on field parcel delineation. On top, the integration of various other in-situ data is advised:

- agricultural in-situ data like JECAM (Joint Experiment for Crop Assessment and Monitoring). etc. wherever possible;
- option to integrate your own data;
- (agricultural) machinery data, support for agro-xml
- drone data
- IoT
- farm management tools such as FaST

As a consequence, the support and further development of various agriculture for research (ARD) initiatives is recommended in the short term. In long-term, a closer collaboration between open EO data service providers and commercial providers are recommended:

- Further finance and support such as Data Cube;
- consider sensor alignment with commercial

- service providers already in the design phase of new sensors;
- invest in research dedicated to data fusion techniques and cross-sensor calibration
 - close collaboration with existing and possible future providers to ensure compatibility in the long run;
 - for new projects it could be suggested and or made mandatory to contribute and share available data (following standard procedures and protocols) with one or several of the available initiatives (DIAS, Euro Data Cube);
 - furthermore, newly developed methods and applications in the field of precision agriculture and overall in the domain of remote sensing are often only trained and tested in small areas of interest and their accuracies are often much lower or highly uncertain when applied in other geographic regions. The lack of standardized and designated testing areas across the globe and the provision of reference datasets (including ground truth) would facilitate the comparability of existing methods and the assessment of their accuracies. Especially the provision of parcel/field level might will drastically improve usability and enable new applications.

Satellite mission

The Copernicus Sentinel fleet is offering unprecedented data and is the most ambitious endeavour in the domain of land monitoring so far. In the context of agricultural monitoring, a couple of aspects are noteworthy.

Given that for agriculture the natural unit is a field/parcel, the spatial resolution is dictated by this aspect. Field sizes vary largely over the globe of course, but overall, spatial resolution is not satisfactory for a large number of applications, a spatial resolution between 1 and 5 meters is desirable.

In contrast to the monitoring of other landscapes and landscape objects, agriculture is highly variable (more variable than forest) and due to crop rotation or other management practices, it might be a different phenology every other year.

In addition to that, during a single growing season, various types of plants will grow and the overall phenological fluctuation is larger than for other land cover and land use. On top of that, the window of opportunity for precision farming is very often

limited to a narrow phenological window (1 or 2 weeks) where the decision-making capabilities of Copernicus are needed. The required temporal resolution for many agricultural applications is therefore very high as well.

The existing Copernicus missions already cover many of the identified requirements of the agriculture domain. Additionally, the foreseen evolution of the existing Copernicus missions and upcoming candidate missions further fulfil the requirements. However, some conclusions can be made for the evolving mission specifications of the Sentinel programme in the long term, especially with regards to spatial resolution (~5m) and revisit times (1-3 days). A number of gaps not covered were identified, in particular concerning VHR optical data, HHR optical data and high-resolution X-band SAR data, all of which are available from commercial providers. With respect to microwave and thermal data (i.e., LSTM and CIMS), further developments may inform future more detailed data requirements on these topics.

ICT aspects

The Copernicus satellite observation capacities are operational and are routinely providing high-cadence monitoring data. In addition to the Copernicus open data hub, five DIAS are operationally providing data access as well as computational resources. However, it must be noted that no certainty about sustainability of DIAS future operations beyond 2021 exists.

The continuation of at least one of the DIAS providers is highly recommended to facilitate the use of Copernicus data and services. The functionality to process and provide higher pre-processing level data and (C)ARD have been demonstrated and is advised to continue.

Overall, the interoperability with other satellite data as well as in-situ data from all parts of the agricultural value chain still has room for improvements. This includes data such as direct meteorological data (forecast as well as historical data), climatic data or other machinery or ground-based soil data. Activities such as the Euro Data Cube and the Agricultural Virtual Laboratory are further follow-up on this approach.

Future scientific priorities

On the basis of the analysis of stakeholder needs a set of future scientific priorities were defined. These priorities could help to policy makers prepare new research programmes and scientific communities to identify new research directions.

The priorities are divided into four thematic groups:

- Biodiversity
 - Analysis of historical development and understanding of interrelation between changes in biodiversity and climate. There exists historical data from EO with relatively high frequency for more than 40 years. For such periods are also available detailed climatic data. Using Artificial Intelligence on this historical data can help us to improve understanding of biodiversity decline;
 - Earth observation data will be ideal source for real time monitoring in large scale and early warning.
- Sustainable farming
 - There is necessary research in different methods of monitoring and data fusion of Satellite data, with IoT data and also integration of climatic data and also existing terrestrial data. It is also important to include commercial very high resolution data, aerial and UAW data. There will be necessary cost benefit analysis and selection of best monitoring methods. The research has cover selection of bands, analysis of time series, data fusion;
 - future precision farming has to be focused on reducing the use of usage chemicals, but guarantee production. So, there is necessary research in nutrition and crop protection, but also in methods of seeding or tillage. Research needs to compare the potential of different approaches to utilisation of Precision Agriculture. For example, now in fertilisation are used two different strategies the Yield-oriented strategy is based on the principle of a higher requirement for nitrogen nutrient to cover a higher level of expected crop yield, which is spatially distributed by the yield productivity zones. The second strategy homogenization is based on the concept of agronomic and nutritional practice developed since the 1980's, when nitrogen is considered a yield-limiting factor and low-yielded areas are supported by higher doses of N. There exist number of similar agronomic problems, for example tillage and non-tillage, etc. and there is necessary provide comparison of all such possibilities and select, such which will help fulfil requirements of Green deal and guarantee sustainability and profitability of agriculture;
- Current Precision Agriculture is mainly focused on site specific operations (Where). Our analysis demonstrates that for future we need much more consider right timing of operation (When), based on analysis of EO and climatic data and also on selection of rights species, chemicals, operations (What);
 - combining satellite data and climatic data from different zones to build strategy for Smart Farming;
 - build new crop growth scenarios under different weather events. Plan optimal timing for different field operations;
 - prediction of disease susceptibility of crop using the temporal crop dynamics from Earth observation data;
 - accurate monitoring of crop phenology;
 - assessment of hydrological flows through a combination of field observations and output from satellite image analysis workflows;
 - augmenting weather and climate monitoring through the use of affordable in-situ weather sensors and remote sensed weather estimates;
 - usage of satellites with Very High Resolution.
- Innovation governance
 - The research has to be focused, how EO can support forming regional, national and local policies. The focus will be on analysis of agriculture production, biodiversity and provide impact assessment of governmental decisions;
 - to be able to fully use the potential of Environmental Observation it is a necessary guarantee in global scale easy discoverability of data. Metadata is necessary to include all history of processing (provenance). There is need for supporting better interoperability of Earth observation data. The recommendation is to organise Coordination and Support Action to support FAIR and Interoperability among existing platforms;
 - the FAIR principles, metadata and interoperability need to be topic;

- effective Agricultural Knowledge and Innovation Systems (AKIS) are key drivers to enhance co-creation and thus speed up innovation and the take-up of results needed to achieve the Green Deal objectives and targets. There is now a large investment into Digital Innovation Hubs (SmartAgriHubs). The model of Digital Innovation Hubs has to be implemented to increase knowledge and awareness about Earth observation methods. The existing infrastructures (DIAS, EUXDAT, EOSC, etc.).
- Enabling technologies
 - Object recognition from satellite and other images. From in situ cameras (on board cameras on Agriculture machinery) strong focus will be on embedding of AI directly into on board computers with possibility to detect objects directly on board for example to detect on the fly pest or weeds. This will be also closely related to robotics system. Similar solutions can be also applied on UAV platforms;
 - analysis of time series. This time series of data coming from IoT technologies, data from satellite and climatic data and their combination will be probably key technologies for building future scenarios Taking into account, that there exist historical satellite and climatic data for more than 40 years, this offers large possibilities for training AI tools on historical data and then use these technologies for building of future scenarios. This could be used in Precision Agriculture, biodiversity, climatic changes mitigation, etc.;
 - trust and provenance of data - it seems that these are two independent issues, but they are linked. When we will share data, which are not open we need to protect this data, so we need tools for tracing data owners, but we also need to make evidence of any operation provided on data and in the end, we need to store this information in metadata. Such functionality could be probably solved by tools for data security in combination with technologies like blockchain, which will give evidence about using data resources and their combination and analysis. This could be done by combination metadata with blockchain technologies;
- development and integration of different data like data from IoT technologies and citizens science;
- advanced 2/3/4 D visualisation methods, virtual reality;
- how to guarantee storage, easy discovery and fast access extremely large data sets;
- HPC computing including parallelization of code;
- development of new hyperspectral systems with high resolution;
- increase resolution of new systems;
- analysis of hyperspectral data including new indexes;
- temporal analysis of data;
- data fusion with other data sources;
- better utilisation of radar and lidar data.

Organisational recommendations

The last set of recommendations was focused on organisational aspects, what has to be done to guarantee better utilisation of EO data in the agriculture segment. We defined ten key recommendations:

- Organise regular workshops and conferences of all interested stakeholders. These workshops and conferences have to lead to the exchange of information, but they also need to educate all stakeholders about new methods;
- support cooperation of all players from the public and private sectors to fulfil the European Green Deal, Destination Earth and the UN SDGs. It will also invite the food industry, machinery, chemical industry, IT industry, financing organizations to build a common environment;
- support new common multi-actor research involving both EO and agriculture/agronomy experts to develop new methods that guarantee food security and agriculture sustainability;
- support the farming sector with open data, including Copernicus and other EO data. This will require additional investments. Put into the practice FAIR principles;
- developed new metadata models and strategy for sharing all data across Agriculture;
- reuse previous solution. On the one side, continue with the development of new

technologies and EO methods to build future Digital Twins. On the other side, there exists a large potential of existing technologies recently developed, which potential is not fully exploited. It's necessary to prepare an overview of existing technologies and discussion among the teams on how to make solutions interoperable and how to re-use existing solutions;

- finance a large number of smaller independent projects for technical development. This can bring new ideas in the short term;
- support standardization efforts and use of existing standards. This needs to be done in cooperation with existing standardization bodies including OGC, ISO, and W3C;
- support large scale coordination actions, which will improve cooperation among different projects, initiatives, and standardization organizations. This needs to support both standardisation and FAIR principles;
- there exist several technical problems, but the biggest problem will be at the level of legislation and financing. It will require a reform of the CAP and also build effective strategies. This cannot be done only on a political level, but it will require communication of politicians with technical experts and researchers to define a successful strategy. For this purpose, it is necessary to establish a forum, where all these players will meet. A new strategy has to be prepared based on expert opinions and scientific results.

Conclusion

Satellite data is an important source of information for future agriculture. The aim of the research, which is emphasized in the article, was to find out the real state of use of EO data for all players who enter the food production process from manufacturers of agricultural machinery, fertilizers, navigation systems through EO experts, farmers and food production complex.

Corresponding authors

Hana Kubičková,

Plan4all z.s., K Rybníčku 557, 330 12 Horní Bříza, Czech Republic

Phone: +420 608 063 093, E-mail: hana.kubickova@plan4all.eu

The paper demonstrates how the EO aspect in support of agriculture should improve. There is a clear need for new data, better spatial and temporal resolutions, new bands, and more dense data. The research, however, revealed that farmers' willingness to pay for such services are limited. This is one of the limiting factors for the future development of EO services in the agriculture domain.

The need for in-situ data is another important issue, helping users to use remote sensing data optimally. The process of deriving useful information from satellite data that can help farmers to make precise decisions must be supported. One of the conclusions on how to help make more intensive use of EO data is the idea the DIAS instances will be self-financed, which could lead to the fact that some of them will be not operational after the end of their contracts.

On the one hand, there are large investments from the public to private to build new solutions and delivery platforms. On the other hand, agriculture is highly fragmented with enormous amounts of players in different sectors (e.g., machinery, insurance, fertiliser producers). Access to knowledge is limited and the current investments are not efficiently utilised. There is an urgent need to verify the investments for all public and private partners and get a deep understanding of the return of investment for all participants as well as verification of climate change and/or environmental positive or negative effects. A new understanding of precision farming services can not only increase production but produce products of higher quality, have fewer negative influences on the environment, and also reduce different environmental risks.

Acknowledgements

The paper was prepared on the base of materials collected by all members of the EO4Agri consortium. This research was funded from the European Union's Horizon 2020 research and innovation programme under grant agreement No 821940.

References

- [1] Anderson, K., Ryan, B., Sonntag, W., Kavvada, A. and Friedl, L. (2017) "Earth observation in service of the 2030 Agenda for Sustainable Development", *Geo-spatial Information Science*, Vol.20, No.2, pp.77-96. E-ISSN 1993-5153, ISSN 1009-5020. DOI 10.1080/10095020.2017.1333230.
- [2] Annex 1 to the Grant Agreement (Description of the Action), *Part B EO4AGRI Bringing together the Knowledge for Better Agriculture Monitoring LC-SPACE-02-EO-2018 Copernicus evolution – Mission exploitation concepts, Description of Action*, 2021. [Online]. Available: [https://ec.europa.eu › ref › h2020-doa-ria-ia-csa_en](https://ec.europa.eu/ref/h2020-doa-ria-ia-csa_en) [Accessed: 20 Sept. 2021].
- [3] Appendix A, EO4Agri-Analysis of previous projects, *EO4Agri-Bringing together the Knowledge for Better Agriculture Monitoring*, 2021. [Online]. Available: <https://zenodo.org/record/4607725#.YFChEa9KhnI> [Accessed: 20 Sept. 2021]. DOI 10.5281/zenodo.4607725.
- [4] Appendix B, EO4Agri-User Requirements and Gap Analysis in Different Sectors, *EO4Agri-Bringing together the Knowledge for Better Agriculture Monitoring* (2021). [Online]. Available: <https://zenodo.org/record/4596548#.YEotgmhKhnI> [Accessed: 20 Sept. 2021]. DOI 10.5281/zenodo.4596548.
- [5] Appendix C, EO4Agri-The statistical summary and response to the main user requirements, *EO4Agri-Bringing together the Knowledge for Better Agriculture Monitoring*, 2021. [Online]. Available: <https://zenodo.org/record/4597166#.YEosmmhKhnI> [Accessed: 20 Sept. 2021]. DOI 10.5281/zenodo.4597166.
- [6] Baer, S. G. and Birgé, H. E. (2018) "Soil ecosystem services: an overview", In: "*Managing Soil Health for Sustainable Agriculture Volume 1: Fundamentals*" (Hardback), Publisher Burleigh Dodds Science Publishing Limited, United Kingdom, ISBN 10 1786761882, ISBN 13 978178676188010. DOI 10.19103/AS.2017.0033.02.
- [7] Campbell, B. M., Hansen, J., Rioux, J., Stirling, C. M., Twomlow, S. and Wollenberg, E. L. (2018) "Urgent action to combat climate change and its impacts (SDG 13): transforming agriculture and food systems", *Current opinion in environmental sustainability*, Vol. 34, pp. 13-20. ISSN 1877-3435. DOI 10.1016/j.cosust.2018.06.005.
- [8] European Commission (2019) "*Communication from the Commission: The European Green Deal*", Communication from the Commission to the European Parliament, the European Council, the Council, the European Economic and Social Committee and the Committee of the Regions the European Green Deal, COM/2019/640 final. [Online]. Available: <https://eur-lex.europa.eu/legal-content/EN/TXT/?qid=1596443911913&uri=CELEX:52019DC0640#document2>. [Accessed: 30 April 2021].
- [9] Crehan, P. and Harper, J. C. (2008) "*10. Foresight in Smaller Countries, The handbook of technology Foresight: Concepts and practice*", 216 p. ISBN 978 1 84844 810 0.
- [10] Crehan, P., Šafář, V. and Charvát, K. (2019) "WP2 – User Requirements and Gap Analysis, D2.1 End User Requirements Collection and Foresight Methodology, *EO4Agri-Bringing together the Knowledge for Better Agriculture Monitoring*". DOI 10.13140/RG.2.2.22392.19206.
- [11] Diacono, M., Trinchera, A. and Montemurro, F. (2021) "An Overview on Agroecology and Organic Agriculture Strategies for Sustainable Crop Production", *Agronomy*, Vol. 11, No. 2, 223 p. E-ISSN 2073-4395 DOI 10.3390/agronomy11020223.
- [12] Druml, S., Charvat, K., Mayer, W., Kolitzus, D., Clergue, L., Horakova, S. and Esbrí M. A. (2020) "D5.5 Collaboration Framework for Global and EU initiatives – Final", *EO4Agri-Bringing together the Knowledge for Better Agriculture Monitoring*. [Online]. Available: https://eo4agri.eu/sites/eo4agri.eu/files/public/content-files/deliverables/EO4AGRI_D5.5-Collaboration-Framework-for-Global-and-EU-initiatives-Final_v3.0.pdf. [Accessed: 30 April 2021].
- [13] European Commission (2021) "*Destination Earth*", Shaping Europe's digital future". [Online]. Available: <https://ec.europa.eu/digital-single-market/en/destination-earth-destine>. [Accessed: 30 April 2021].

- [14] FAO (2017) "*The future of food and agriculture – Trends and challenges*", Rome. ISBN 978-92-5-109551-5.
- [15] FAO (2020) "*Disaster Risk Reduction Challenge Badge*", YUNGA learning and action series – Challenge badges", Rome, Italy. ISBN 978-92-5-132079-2. DOI 10.4060/ca7445en.
- [16] Horizon 2020 Work Programme 2018-2020 (2020) "*Chapter 9 Food security, sustainable agriculture and forestry, marine, maritime and inland water research and the bioeconomy*", European Commission Decision C (2020)6320 of 17 September 2020. [Online]. Available: https://ec.europa.eu/research/participants/data/ref/h2020/wp/2018-2020/main/h2020-wp1820-food_en.pdf. [Accessed: 30 April 2021].
- [17] Charvat, K. and Gnip, P. (2009) "Analysis of external drivers for farm management and their influences on farm management information systems", *Precision agriculture*, Vol. 9, No. 915. ISSN 1385-2256, E-ISSN 1573-1618.
- [18] JECAM (2021) "*Joint Experiment for Crop Assessment and Monitoring*". [Online]. Available: <http://jecam.org/>. [Accessed: 30 April 2021].
- [19] Jedlička, K., Hájek, P., Charvát, K. and Valeš, J. (2019) "Exploitation of calculated local temperature topography variations-a case study in Kenya", In *2019 IST-Africa Week Conference (IST-Africa)*, pp. 1-11. IEEE. DOI 10.23919/ISTAfrICA.2019.8764890.
- [20] Kolitzus, D. (2020) "WP3 – Scientific & Technical Support Actions to improve Copernicus Ability for Agriculture D3.11 Towards the improvement of Copernicus Service Components in support to Agriculture", *EO4Agri-Bringing together the Knowledge for Better Agriculture Monitoring*. [Online]. Available: <https://eo4agri.eu/deliverables>. [Accessed: 25 Sept. 2021].
- [21] Kubičková, H., Šafář, V., Kozel, J., Král, M., Křivánek, Z., Řezník, T., Šafář, V., Šmejkal, J., Vrobel, J., Zadražil, F., Charvát, K., Horáková, Š., Bye, B. L. and Mildorf, T. (2021) "WP2 – User Requirements & GAP Analysis D2.4 Final Workshop-User Requirements and Gap Analysis in Different Sectors Report", *EO4Agri-Bringing together the Knowledge for Better Agriculture Monitoring*. [Online]. Available: <https://eo4agri.eu/deliverables>. [Accessed: 25 Sept. 2021].
- [22] Lampridi, M. G., Sørensen, C. G. and Bochtis, D. (2019) "Agricultural sustainability: A review of concepts and methods", *Sustainability*, Vol. 11, No. 18. E-ISSN 2071-1050. DOI 10.3390/su11185120.
- [23] Montañana, J. M., Marangio, P. and Hervás, A. (2020) "Open Source Framework for Enabling HPC and Cloud Geoprocessing Services", *AGRIS on-line Papers in Economics and Informatics*, Vol. 12, No. 4, pp. 61-76. ISSN 1804-1930. DOI 10.7160/aol.2020.120405.
- [24] Navrozidis, I., Alexandridis, T. K., Moshou, D., Pantazi, X. E., Tamouridou, A. A., Kozhukh, D., Castef, F., Lagopodi, A., Zartaloudis, Z., Mourelatos, S. and de Santos, F. J. N. (2019) "Olive trees stress detection using Sentinel-2 images" In: *IGARSS 2019-2019 IEEE International Geoscience and Remote Sensing Symposium*, IEEE, pp. 7220-7223. DOI 10.1109/IGARSS.2019.8898076.
- [25] Sivakumar, M. V. K. (2005) "Impacts of Natural Disasters in Agriculture, Rangeland and Forestry: an Overview", In: Sivakumar M. V., Motha R. P. and Das H. P. (eds) "*Natural Disasters and Extreme Events in Agriculture*", Springer, Berlin, Heidelberg. E-ISBN 978-3-540-28307-2, ISBN 978-3-540-22490-7 DOI 10.1007/3-540-28307-2_1.
- [26] Šafář, V., Charvat, K., Horakova, S., Orlickas, T., Rimgaila, M., Kolitzus, D. and Bye, B. L. (2020). "WP2-User Requirements & GAP analysis D2.2 Initial Workshop-User Requirements and Gap Analysis in Different Sectors Report Version 2.0", *EO4Agri-Bringing together the Knowledge for Better Agriculture Monitoring*. DOI 10.13140/RG.2.2.14943.48805.
- [27] Šafář, V., Charvát, K., Horáková, Š., Orlickas, T., Rimgaila M., Kolitzus, D., Bye, B. L., Kaas, O., Kepka Vichrová, M., Křivánek, Z., Vrobel, J., Kvapil, J., Křivánková, K., Leitner, F., Zadražil, F., Kozhukh, D., Šnevajs, H. and Kubičková, H. (2020) "WP2-User Requirements & GAP analysis D2.3 Mid-Term Workshop-User Requirements and Gap Analysis in Different Sectors", *EO4Agri-Bringing together the Knowledge for Better Agriculture Monitoring*. DOI 10.13140/RG.2.2.30042.98244.

- [28] Šafář, V., Kubičková, H., Krivanek, Z., Křivánková, K., Kvapil, J., Kozhukh, D., Kepka Vichrová, M., Čerbová, K., Charvat, K., Horakova, S., Druml, S., Mayer, W. H., Mayer, S., Mildorf, T., Bye, B. L. and Esbrí, M. A. P. 2020) "D6.6 Strategic Research Agenda Report", *EO4Agri-Bringing together the Knowledge for Better Agriculture Monitoring*. DOI 10.13140/RG.2.2.26922.34242.
- [29] Sustainable Development GOALS (2021) "*The Sustainable Development Agenda*". [Online]. Available: <https://www.un.org/sustainabledevelopment/development-agenda>. [Accessed: 25 Sept. 2021].
- [30] Whitcraft, A. K., Becker-Reshef, I. and Justice, C. O. (2015) "A framework for defining spatially explicit earth observation re-quirements for a global agricultural monitoring initiative (GEOGLAM)", *Remote Sensing*, Vol. 7, No. 2, pp. 1461-1481. E-ISSN 2072-4292. DOI 10.3390/rs70201461.
- [31] Zhao, X., Castka, P. and Searcy, C. (2020) "ISO Standards: A Platform for Achieving Sustainable Development Goal 2", *Sustainability*, Vol. 12, No. 22. E-ISSN 2071-1050. DOI 10.3390/su12229332.

The Impact of Subsidies on the Development of Beekeeping in the Czech Republic

Iva Živělová¹, Eliška Svobodová¹, Jozef Palkovič²

¹ Department of Regional and Business Economics, Faculty of Regional Development and International Studies, Mendel University in Brno, Czech Republic

² Department of Statistics and Operations Research, Faculty of Economics and Management, Slovak University of Agriculture in Nitra, Slovak Republic

Abstract

Given its role in landscape sustainability and health benefits, beekeeping is supported in all EU countries. The paper focuses on the assessment of the impact of beekeeping subsidies on the number of bee colonies in the Czech Republic. Subsidies in the Czech Republic are provided from national sources (state budget), from the budgets of individual regions and from EU sources. The paper presents the development of the number of bee colonies in the Czech Republic from 1990 to 2018. Until 2008, the number of bee colonies in the Czech Republic was decreasing. A significant increase occurred only in 2013. The influence of the amount of subsidy on the number of bee colonies was analysed using a panel data model and the Pearson correlation coefficient. The results show that subsidies have a significant positive influence on the number of bee colonies in Czech Republic and also in the individual regions of the Czech Republic. In terms of the specific focus of subsidies, we can observe a significant positive dependence between the number of bee colonies per beekeeper and technical support. Subsidies for the fight against varroosis are also very important.

Keywords

Number of bee colonies per km²; national sources of finance; EU sources of finance; technical support; fight against varroosis.

Živělová, I., Svobodová, E. and Palkovič, J. (2022) "The Impact of Subsidies on the Development of Beekeeping in the Czech Republic", *AGRIS on-line Papers in Economics and Informatics*, Vol. 14, No. 1, pp. 125-134. ISSN 1804-1930. DOI 10.7160/aol.2022.140110.

Introduction

Many Czech and foreign authors deal with the problems of beekeeping, its development and impact on the environment and human health as well as with the sources of funding, which include subsidies from different sources. The results of their work can be divided into two areas.

The first area deals with beekeeping from the perspective of the importance of bees as important pollinators, ways of beekeeping and bee diseases and thus it addresses beekeeping rather from a biological, technical, technological and environmental point of view. These authors include, for example, Waring (2011), who focuses on the problematics of beekeeping from a complex perspective. Crane (2014) presents the historical development of beekeeping, the basic structure of beehives and recommended practices

of beekeeping. Gallai et al. (2009), William (1994) and Klein et al. (2007), Goodrich (2019) emphasizes the essential importance of bees in terms of plant pollination. However, there are also authors such as Geldmann and González-Varo (2018), who point out the fact that support for beekeeping has a negative impact on the existence of other pollinators (different insects), and that massive support for beekeeping significantly reduces their numbers.

Therefore, they understand the support for beekeeping in terms of economic interest rather than environmental. Bee diseases causing their mortality are dealt with by Haves (2007), who was mainly involved in research into the bee disease known as CCD – Colony Collapse Disorder, which spread in the USA and caused considerable colony losses.

Research into bee diseases was also done by Huang

and Solter (2013), Oliver (2010), Chauzat et al (2013) and many others. An extensive study was also conducted by Genersch et al. (2010), who investigated the causes of winter bee mortality.

The second area, which the authors focus on, is the economic area related to the quantity and price of bee products, their market application and the sources of beekeeping financing, including subsidies supporting the development of beekeeping.

Here we can mention the work of Demircan et al. (2016) which deals with the state and development of beekeeping in Turkey, comparing honey production with other states and dealing with honey consumption and types of support for this sector. In their next paper, Sert and Demircan (2018), Demircan et al. (2016), Borowska (2016) focus on the economic analysis of beekeeping, dealing with the structure of beekeeping enterprises by their size, cost, profitability and the effect of the enterprise size on its economic performance. Aksoy et al. (2018) focus on factors affecting honey production, Majewski (2017), Jarka, Trajer (2018) on the amount and types of support provided to the EU beekeepers. Karadas and Kadirhanogullari (2017) investigate factors affecting honey and wax yields as the main products of beekeeping.

The aim of this paper is to assess the benefits of subsidies provided from national and EU funds for the development of beekeeping in the Czech Republic.

Material and methods

The article is based on a summary of the current state of knowledge published by various authors in the broader context of beekeeping development. In order to characterize the basic indicators characterizing the beekeeping sector, it mainly uses publicly available data from the Czech Statistical Office and the Ministry of Agriculture of the Czech Republic databases, which are further modified for the purpose of necessary interpretation of the context considered.

As indicators of beekeeping were analyzed following variables:

- Number of beekeepers
- Number of colonies
- Number of colonies per beekeeper
- Production of honey (in tonnes)
- Production of beeswax (in tonnes)

These indicators were investigated in relation to support indicators measured (in thousand CZK):

- Technical support
- Fight against varroosis
- Rationalization of movement of colonies
- Honey analysis
- Restocking of colonies
- Possibility of subsidies

In the analysis of subsidies impact included also size of the region (in hectares) and temperature (°C) as explanatory factors.

The statistical significance of relationship in the development of support and the number of bee colonies and bee products were verified using the Pearson correlation coefficient, which can be calculated according to the following formula 1.

$$\rho_{xy} = \frac{cov(xy)}{\sigma_x \sigma_y} \quad (1)$$

in which the covariance of the variables x and y is divided by the product of their standard deviations ($\sigma_x \sigma_y$). The Pearson correlation coefficient can take values from $<-1,1>$. Values close to zero mean no or weak dependence, values close to 1 strong positive dependence and values close to -1 strong negative dependence. The value of the coefficient was calculated as a sample characteristic and that is why it is necessary to verify that its value is significantly different from zero and relationship is significant. Significance is evaluated by comparing the p-value with the relevant significance level α . P-value lower than significance level α means statistical significance of the correlation coefficient, p-value higher than α means that the correlation coefficient is statistically insignificant and there is no dependency between the variables.

The impact of subsidies on the number of bee colonies was quantified using a panel data model with random effects. This type of model was chosen as way, how to include more data in the analysis, and avoid the variation of regression function parameters due to heterogeneity of cross-sectional units (regions). Model allows to estimate effect of subsidies using available data for all regions together, and express specific character of each region at the same time. Panel data for individual regions of the Czech Republic covering period 2010-2016 were used to estimate the parameters. A logarithmic function was used to estimate the model for more convenient shape of function and easier interpretation of results. The model was estimated in the form of equation 2.

$$y_{it} = \beta_0 + x'_{it}\beta + \alpha_i + u_{it} \quad \alpha_i \sim \text{iid}(0, \sigma_\alpha^2)$$

$$u_{it} \sim \text{iid}(0, \sigma_u^2) \quad (2)$$

Where y_{it} is a log-value of the number of bee colonies, x'_{it} is a vector of log-values of explanatory variables, β_0 is intercept, α_i is a random error specific to individual cross-sectional units, u_{it} a random error common to all cross-sectional units. The explanatory variables were: area, temperature and individual types of support: technical support, the fight against varroosis, the rationalization of the movement of honey bee colonies, honey analysis, restocking of bee colonies and the use of subsidies. Insignificant variables were eliminated from all the considered variables by stepwise elimination, also with regard to strong collinearity among the explanatory variables.

The consistency of the estimated model parameters with random effects as well as the suitability of this type of model was verified using the Hausman test.

$$m = q'(var\hat{\beta}_{FE} - var\hat{\beta}_{RE})^{-1}q,$$

where $q = \hat{\beta}_{FE} - \hat{\beta}_{RE}$ and β_{FE} are estimated parameters of the fixed-effect model, β_{RE} are estimated parameters of the random effects model, $var\hat{\beta}_{FE}$ is the variability in the estimation of parameters of a fixed-effect model, and $var\hat{\beta}_{RE}$ is the variability in the estimation of the random effect model parameters.

The resulting test statistic has a χ^2 distribution with degrees of freedom equal to the number of estimated parameters. P-value higher than the selected significance level α implies the acceptance of the null hypothesis of the consistency of the estimated model

with random effects. Rejection of the null hypothesis implies inconsistency in the estimated parameters of the random effect model and the recommendation to use a fixed effect model.

Suitability of random effect model was verified also by Breusch-Pagan test, which was used to confirm the hypothesis about different specific random error variability in regions, which is important assumption for using random effects model.

Results and discussion

The development of beekeeping in the Czech Republic

Beekeeping has a long tradition in the Czech Republic. All countries, including the Czech Republic, recognize the importance of bees for plant pollination and ecosystem stabilization. Beekeeping has been gaining importance especially in recent years as the number of other significant pollinators has decreased due to the transformation of agricultural landscapes. According to Jarka, Trajer (2018) the importance of bees for agricultural and fruit production is due to the fact, that over 70 of the 100 most important crops for humans are pollinated by bees. According to Majewski (2017) pollinating insects, especially honey bees, account for about 35% of the world's crop production. In addition to this basic function of bees, beekeeping brings products important to human health, which include honey and other products such as beeswax, bee glue, royal jelly, bee pollen and bee venom.

The development of the number of beekeepers and bee colonies between 1990 and 2018 is shown in Figure 1.

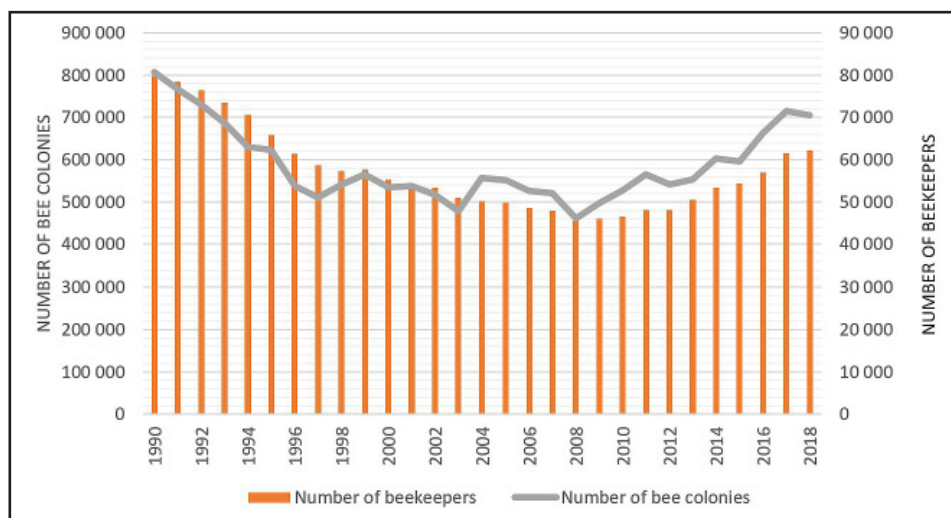

Source: Ministry of Agriculture of Czech Republic (2017, 2018); own calculation

Figure 1: The number of beekeepers and bee colonies in 1990-2018.

As can be seen from Figure 1, there were 807 429 colonies in 2009. However, the number gradually decreased until it reached its minimum in 2008. This year, only 461 086 colonies were reported, i.e. 57% of the original number. The main reason for the decline in the number of bee colonies was considered to be the economic effects which manifested themselves in the whole agriculture, and adverse weather conditions. Chauzat et al. (2013) confirm the influence of climatic conditions on beekeeping development in the EU. Bee disease, especially varroosis, and other diseases such as American foulbrood also contributed to the decline. According to Chauzat et al. (2013) the main reason for the colony losses in the EU is the varroosis. He thinks that the reliable figures on the number of honeybee colonies and their geographical locations are the key factors required for effective control of honeybee diseases. We also think that the supports for beekeepers are able to reduce the level of diseases because of their focus. As can be seen due to different types of support, the number of bee colonies gradually increased to 704 520 in 2018. The number of bee colonies differs among regions.

Hive density in the Czech Republic, measured by the number of bee colonies per km², increased in 2017 compared to 2010, as can be seen in Figure 2.

The number of bee colonies has increased in all regions of the Czech Republic, mostly in the South Moravian, Zlín and Moravian-Silesian regions. In South Moravia, it rose to 11.15 in 2017, compared to 8.25 in 2010. The district of Brno-venkov contributed most to this increase. In the Zlín region, the number of bee colonies increased from 8.61 to 12.2 colonies per km² in these years. The district of Vsetín contributed

the most to this increase. In the Moravian-Silesian region, the original value of 7.98 in 2010 increased to 11.76. The district of Frýdek-Místek contributed the most to this increase.

Interest in beekeeping started to decline in 1990, which was reflected in the decrease in the number of beekeepers in the Czech Republic. The development of the number of beekeepers showed a similar trend as the number of bee colonies, which decreased until 2008. Significant growth started only in 2013, when the number of beekeepers rose to 50 471 and continued to reach 62 327 in 2018.

Support for beekeepers in the Czech Republic

Increase in bee colonies after 2004 and especially after 2010 was also influenced by grants to support this activity. Subsidies are provided from both national and EU sources. According to Jarka, Trajer (2018) that the support of the beekeeping sector is not only because of the economic reasons (helps to improve beekeepers competitiveness), but also because of its participation in the creation of the public goods, thus affecting the level of sustainable development of rural areas. Majewski (2017) agrees with the influence of bees on the yield and quality of crops, as well as on the biodiversity. In addition, according to him this points to the need to support beekeeping.

Support for beekeeping in the Czech Republic is based on the overall strategy of the Ministry of Agriculture of the Czech Republic, which set this task in the Strategy of the Ministry of Agriculture of the Czech Republic with a view to 2030 (Ministry of Agriculture 2016). Here the Ministry of Agriculture of the Czech Republic set the following strategic goal: Stabilization of the number of bee colonies in the Czech

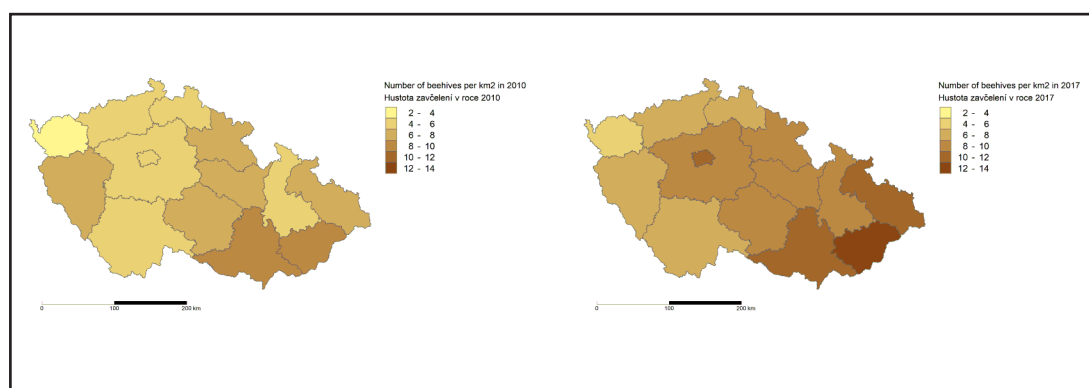

Source: Ministry of Agriculture of Czech Republic (2019); own calculation

Figure 2: Number of bee colonies per km².

Republic, support for their even distribution in the landscape in order to ensure biological balance in pollination of cultivated and wild plants and support for sufficient supplies of bee colonies in agricultural areas. The use of national and EU funds to support both new and existing beekeepers can be considered as one of the basic measures to achieve this goal.

National subsidies are provided on the basis of Act No. 252/1997 Sb. on Agriculture, as amended, in the form of subsidy I.D – Support for beekeeping.

The aim of this subsidy program is to ensure pollination of agricultural entomophilous plants. The subsidy has been provided through the Czech Beekeepers Association and its organizational units since 1996 continuing the history of support for beekeeping in the Czech Republic.

Table 1 gives an overview of the use of this subsidy in 2010-2017.

The data clearly show that after some stagnation in 2013-2015, the total amount of subsidies used to ensure pollination of entomophilous plants increased significantly. Compared to 2015, it increased by 31% in 2016, while at the same time the average subsidy per colony increased by 15%. The slower increase in the total subsidy per colony than the increase in the total sum of subsidies is due to the growing total number of colonies, which is the intention of this subsidy policy.

Beekeeping in the Czech Republic is supported not only from the state budget through the National Subsidy Programme I.D – Support for beekeeping but also from the budgets of individual regions. The form and amount of this support varies.

A substantial part of the funds allocated

to beekeepers whose aim is to renew, expand and improve the health of bees etc., consists of subsidies from common sources of the EU and national sources in the proportion of 50% of EU resources and 50% of national resources. Since 2005, they have been provided in the form of three-year programmes on the basis of Government Regulation No. 197/2005 Sb., Regulation of the European Parliament and of the Council (EU) No. 1308/2013 and Commission Delegated Regulation (EU) No. 2015/1336. Since 2005, subsidies from common EU and Czech sources have been focused on five basic areas: Technical Support, Fight against Varroosis, Rationalization of the Movement of Honey Bee Colonies, Honey Analysis and Restocking Honey Bee Colonies. Technical Support offers subsidies for beekeeping courses, management of youth beekeepers groups and the equipment necessary for harvesting and processing apiary products. Fight against Varroosis includes financial support for all costs of medicinal products, remedies and aerosols to treat or prevent varroosis. Rationalization of the Movement of Honey Bee Colonies supports the purchase of specialist equipment to move honey bee colonies for the purpose of pollination or harvest. Honey Analysis allows to get funds for honey analysis focusing on the presence of American foulbrood spores as one of the dangerous types of bee diseases. Restocking Honey Bee Colonies supports the breeding of queen bees from a recognized breeding programme pursuant to Section 5 of Act No. 154/2000 Sb. On the improvement, breeding and registration of livestock and amending certain related acts.

Year	Total value of I.D subsidies (in thousand EUR)	Value of subsidies paid by the Ministry of Agriculture (in thousand EUR)	I.D subsidies paid back to the Ministry of Agriculture (in thousand EUR)	Average value of subsidies per 1 colony (in EUR)
2010	3 716	2 746	3	5
2011	3 979	2 155	3	4
2012	3 799	2 807	7	5
2013	3 883	2 977	3	5
2014	4 256	2 979	3	5
2015	4 209	2 974	4	5
2016	4 675	3 896	5	6
2017	N/A	3 890	N/A	6

Source: Ministry of Agriculture of Czech Republic (2019); own calculation

Table 1: Use of subsidies from the national subsidy program I.D in 2010-2017.

Figure 3 clearly shows the distribution of funds used in individual years.

The graph clearly shows that until 2017, the funds for beekeeping were mostly used for technical support. However, the funds allocated for the fight against varroosis increased gradually until 2018 when the total amount exceeded the amount of funds for technical support. Thus, the biggest share representing 47% of the total amount of funds was used for the fight against varroosis. The remaining areas show a decreasing share of total subsidies in the time series.

Measuring dependence between beekeeping and subsidies

Correlation coefficient values that measure the strength of dependence between the amount of subsidy and the development of the number of beekeepers, bee colonies, bee colonies

per beekeeper and the production of honey and beeswax are given in Table 2.

The analysis was conducted utilizing annual data for the period 2006–2017. Due to the relatively lower number of observations, some values were statistically insignificant. However, based on the results, it is possible to conclude that the amount of subsidy had a significant positive influence on the number of colonies. In terms of the specific focus of subsidies, we can observe a significant positive dependence on the level of 0.1 between the number of bee colonies per beekeeper and technical support. Honey analysis subsidy correlates significantly with honey and beeswax production. The most significant positive effect was recorded in case of subsidies focused on fight against varroosis and number of beekeepers and colonies.

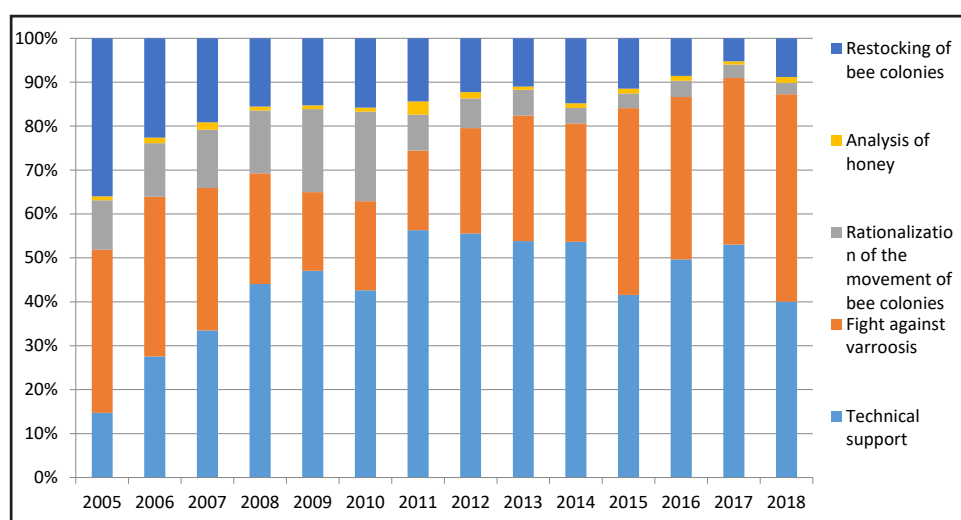

Source: Ministry of Agriculture of Czech Republic (2017); The state agricultural intervention fund (2018); own calculation

Figure 3: The structure of the use of beekeeping funds from the EU and the Czech Republic sources in 2005-2018.

	number of beekeepers	number of colonies	number of colonies per beekeeper	honey production	beeswax production
Technical support	0.39	0.47	0.51*	0.06	0.35
Fight against varroosis	0.85***	0.77***	0.30	0.26	0.56*
Rationalization of movement of colonies	- 0.71***	- 0.65**	- 0.30	-0.52	- 0.73***
Honey analysis	- 0.08	0.10	0.53	0.56*	0.51*
Restocking of colonies	- 0.68**	- 0.61**	- 0.21*	-0.46*	- 0.56*
Possibility of subsidies	0.49	0.55*	0.50	0.10	0.41

Note: *** level significance $\alpha=0.01$ ** level significance $\alpha=0.05$ * level significance $\alpha=0.1$

Source: Ministry of Agriculture of Czech Republic (2019);own calculation

Table 2: Dependence between subsidies and bee colonies, honey and beeswax production.

Quantification of the impact of subsidies on the number of bee colonies

The influence of the amount of subsidy on the number of bee colonies was analysed using a panel data model with random effects. The model was quantified using a panel of annual data for individual regions of the Czech Republic for the period 2010-2017. The dependent variable in the model was the number of bee colonies in the region, explanatory variables were subsidies and other factors that could affect the number of bee colonies, such as the size of the area, amount of precipitation and temperature. Of the considered types of individual subsidies, it was impossible to simultaneously use more explanatory variables in the model due to the strong collinearity between these variables. In order to assess the significance of the subsidies objectively, their individual types had to be included in the model separately. Logarithmic shape, which is suitable in terms of reducing the degree of variability in the data and the interpretability of the estimated elasticities in percentage, was chosen for the model. The interpreted model was achieved as a result of the gradual elimination of insignificant variables from the original model with all the explanatory factors considered. A random effect model was used to account for individual effects in the data panel, the existence of which was confirmed by the Breusch-Pagan test. This model is more suitable owing to the higher number of cross-sectional units and the lower number of analyzed periods. Its suitability was confirmed by the Hausman test.

The results are shown in Table 3 below.

The results show that subsidies and the size of the region have a significant influence on the number of bee colonies. In the case of land,

an increase of 1 % results in a 0.84 % increase in bee hives. In the case of subsidies, an increase of 1 % results in a 1.34 % increase in beehives. It can therefore be concluded on the basis of the results obtained that the subsidies have a significant effect on the number of bee colonies at the significance level $\alpha=0,05$. The model was evaluated as significant despite explaining only 18 % of the variability in the number of bee colonies.

A similarly significant result would be achieved if a variable measuring a specific subsidy for the fight against varroosis was used instead of the subsidy. These variables could not be used at the same time because collinearity would always result in one of them being insignificant. An alternative model without the subsidy for the fight against varroosis is given in Table 4 below.

The impact of the size of the area on the number of bee colonies is very similar to that estimated in the previous model. The effect of the support for the fight against varroosis is highly significant. It can be concluded that a 1 % increase in funds to support the fight against varroosis results in a 0.37 % increase in colonies. The model was significant and explains 26 % variability of bee colonies.

On the basis of the results obtained, it can be concluded that subsidies have a significant positive influence on the number of bee colonies in individual regions of the Czech Republic. From different types of subsidies was recorded the most significant positive influence on the number of bee colonies and beekeepers in case of subsidies focused on fight against varroosis. Performed analysis was limited by current availability of data. To offer more complex insights

	coefficient	standard error	t stat.	p-value	significance
const	-15.256100	6.407450	-2.381	0.0191	**
l_size	0.846132	0.215268	3.931	0.0002	***
l_use of subsidy	1.339420	0.518320	2.584	0.0112	**

Source: Ministry of Agriculture of Czech Republic (2019), Czech Statistical Office (2019); own calculation

Table 3: Results of the model with random effects – using subsidies.

	coefficient	standard error	t stat.	p-value	significance
const	-4.292	2.944770	-1.458	0.1481	
l_size	0.862741	0.214746	4.017	0.0001	***
l_fight against varroosis	0.370779	0.081628	4.542	1.54E-05	***

Source: Ministry of Agriculture of Czech Republic (2019), Czech Statistical Office (2019); own calculation

Table 4: Results of the model with random effects – support for the fight against varroosis.

into effects of subsidies, would require analysis including more data, and alternative factors influencing beekeeping in Czech Republic.

Conclusion

Beekeeping is a specific sector of agricultural production which not only fulfils the production function but also contributes significantly to the sustainability of the landscape. Bees are especially important as pollinators of agricultural, forest and wild growing plants that ensure biological balance in the landscape. Gallia et al. (2009) Beekeeping also fulfils a social function as a leisure time activity. as mentioned by Aksoy et al. (2018), Borowská (2016), Demincan et al. (2016), Chauzat et al. (2013). Young people can join beekeepers groups and gain information on the social importance of beekeeping.

For the above-mentioned importance of beekeeping, this sector is supported by various measures in all states (Jarka, Trajer, 2018). The Czech Republic benefits from 5 available measures, most of which are used for the area of Technical Support that helps to acquire the tools necessary for harvesting and processing bee products, and for the area of Fight against Varroosis where beekeepers can receive funds for medicinal products, remedies and aerosol to treat or prevent varroosis. According to Borowská (2010) these are the considered important function of subsidies.

This paper proves the significant influence of subsidies on the increase in bee colonies, therefore it is clear that subsidies are one of the tools which contribute to the increase in hives in the Czech Republic. This is further documented by the number of applications for subsidies, which exceeds the total amount of funds to be allocated. The most required subsidies for Technical Support cover the cost of honey harvesting/processing tools and the cost of education programs and young beekeepers clubs

management. The increasing number of beekeepers in recent years suggests that subsidies contribute to the development of beekeeping. In particular, they facilitate the restocking of lost colonies and thus the stabilization of bee colonies in the Czech Republic. By addressing young people, they also contribute to an increase in the number of beekeepers, which exceeds the natural generational replacement. Of great importance are subsidies for the fight against varroosis, which has been the cause of sizeable bee colony deaths. It is compulsory for the State Veterinary Administration of the Czech Republic to perform annual sampling from all the habitats in the Czech Republic in order to detect this disease and ensure necessary treatment in time. The increasing amount of this subsidy and the rise of beekeeping is evidence of help in fighting this disease.

The Czech Republic is one of the countries with the highest number of bee colonies per km², which are distributed throughout the country. This ensures uniform pollination and thus the maintenance of ecological balance and biological diversity, which also affects crop yields. However, this situation is not typical for all EU countries.

Therefore, in its report on prospects and challenges for the EU beekeeping sector of 8 February 2018, the European Parliament proposed that beekeeping be given priority in the proposals for the future agricultural policy expected after 2021, and that the EU budget be increased for national beekeeping programmes to reflect the overall importance of this sector.

Acknowledgments

This work was supported by the Faculty of Regional Development and International Studies, Mendel University of Brno within the project IGA 006/2019 Economic and Social Contribution of Food Industry Enterprises to Regional Development.

Corresponding authors

prof. Ing. Iva Živělová, CSc.

Department of Regional and Business Economics, Faculty of Regional Development and International Studies, Mendel University in Brno, Zemědělská 1, 613 00 Brno, Czech Republic

Phone: +420 545 136 404, E-mail: iva.zivelova@mendelu.cz

References

- [1] Aksoy, A, Ertürk, Y. E., Erdoğan, S., Eydurán, E. and Tariq, M. M. (2018) "Estimation of Honey Production in Beekeeping Enterprises from Eastern Part of Turkey through Some Data Mining Algorithms", *Pakistan Journal Zoology*, Vol. 50, No. 6, pp. 1999-2398. ISSN 0030-9923. DOI 10.17582/journal.pjz/2018.50.6.2199.2207.

- [2] Borowska, A. (2016) "Changes and Evolutions of Beekeeping Sector in Poland between 2010-2015, in the Context of EU Adhesion", *Problem of World Agriculture*, Vol. 16 (XXXI), No. 4, pp. 74-85. ISSN 2081-6960.
- [3] Crane, E. A. (2004) "Short history of knowledge about honey bees (*Apis*) up to 1800", *Bee World*, Vol. 85, No. 1, pp. 6-11. E-ISSN 2376-7618, ISSN 0005-772X. DOI 10.1080/0005772X.2004.11099604.
- [4] Czech Statistical Office (2020) [Online]. Available: <https://www.czso.cz/> [Accessed: 14 June 2020].
- [5] Demircan, V., Sarica, D. and Sert, D. (2016) "Current Status and Development in Beekeeping Sector in Turkey and in The World", *Lucrări Științifice*, Vol. 59, No. 1, pp. 211-218. ISSN 1454-7414.
- [6] Gallai, N., Salles, J. M., Settele, J. and Vaissière, B. E. (2009) "Economic valuation of the vulnerability of world agriculture confronted with pollinator decline", *Ecological Economics*, Vol. 68, No. 3, pp. 810-821. ISSN 0921-8009. DOI 10.1016/j.ecolecon.2008.06.014.
- [7] Geldmann, J. and Gonzáles-Varo, J. P. (2018) "Conserving honey bees does not help wildlife", *Science*, Vol. 359, No. 6374, pp. 392-393. ISSN 1095-9203. DOI 10.1126/science.aar2269.
- [8] Genersch, E., Von Der Ohe, W., Kaatz, H., Schroeder, A., Otten, C., Büchler, R., Berg, S., Ritter, W., Mühlen, W., Gisder, S., Meixner, M., Liebig, G. and Rosenkranz, P. (2010) "The German bee monitoring project: A long term study to understand periodically high winter losses of honey bee colonies", *Apidologie*, Vol. 41, pp. 332-352. E-ISSN 1297-9678, ISSN 0044-8435. DOI 10.1051/apido/2010014.
- [9] Goodrich, B. K. (2019) "Do more bees imply higher fees? Honey bee colony strength as a determinant of almond pollination fees", *Food Policy*, Vol. 83, pp. 150-160. ISSN 0306-9192. DOI 10.1016/j.foodpol.2018.12.008.
- [10] Haves, J. (2007) "Colony Collapse Disorder (CCD)", *American Bee Journal*, Vol. 147, No. 12, pp. 1023-1025. ISSN 0002-7626. DOI 10.32473/edis-in720-2007.
- [11] Huang, W. F. and Solter, L. F. (2013) "Nosema apis and Nosema ceranae; A Comparative Study in the Honey Bee Host", *American Bee Journal. United States*, Vol. 15, No. 3, pp. 277-278. ISSN 0002-7626.
- [12] Chauzat, M.-P., Cauquil, L., Roy, L., Franco, S., Hendriks, P. and Ribière-Chabert, M. (2013) "Demographics of the European Apicultural Industry", *PLoS ONE*, Vol. 8, No. 11. E-ISSN 1932-6203. DOI 10.1371/journal.pone.0079018.
- [13] Jarka, S. and Trajer, M. (2018) "Support for Beekeeping Sector in Poland and the European Union", *Problem of World Agriculture*, Vol. 18 (XXXIII), No. 4, pp. 183-191. ISSN 2081-6960. DOI 10.22630/PRS.2018.18.4.109.
- [14] Karadas, K. and Kadirhanogullari, I. H. (2017) "Predicting Honey Production using Data Mining and Artificial Neural Network Algorithms in Apiculture", *Pakistan Journal of Zoology*, Vol. 49, No. 5, pp. 1611-1619. ISSN 0030-9923. DOI 10.17582/journal.pjz/2017.49.5.1611.1619.
- [15] Klein, A. M., Vaissière, B. E., Cane, J. H., Steffan-Dewenter, I., Cunnigham, S. A., Kremen, C. and Tscharntke, T. (2007) "Importance of pollinators in changing landscapes for world crops", *Proceedings of the Royal Society*, Vol. 274, pp. 303-313. ISSN 0962-8452. DOI 10.1098/rspb.2006.3721.
- [16] Majewski, J. (2017) "Beekeeping support in the European union countries", *Scientific Papers Series Management, Economic Engineering in Agriculture and Rural Development*, Vol. 17, No. 4, pp. 193-107. E-ISSN 2285-3952, ISSN 2284-7995.
- [17] Ministry of Agriculture of Czech Republic (2019) "Beekeeping Statistics 2016, 2017", [Online]. Available: <http://eagri.cz/public/web/mze/> [Accessed: 10 Aug 2019].
- [18] Ministry of Agriculture of Czech Republic (2019) "Central Registry Office. Numbers of bee colonies by district 2010 – 2018".

- [19] Oliver, R. (2010) "Sick bees", *American Bee Journal*, Vol. 150, No. 8, pp. 767-772. ISSN 0002-7626.
- [20] Sert, D. and Demircan, V. (2018) "Economic Analysis of Beekeeping Farms: A Case Study of Isparta Province in Turkey", *International Conference: Agriculture for Life, Life for Agriculture*, Section 7, Management and Economics of Rural Areas, Book of Abstracts, p. 29, June 7 - 9, 2018, Bucharest, Romania.
- [21] The State Agricultural Intervention Fund (2018) "Press Release 2018" [Online]. Available: <https://www.szif.cz/cs> [Accessed: 20 Nov 2019].
- [22] Waring, A. and Waring, C. (2011) "Brilliant beekeeping", London: Flash. ISBN 9781444140071.
- [23] Williams, I. H. (1994) "The dependence of crop production within the European Union on pollination by honey bees", *Agricultural Zoology Reviews*, Vol. 6, pp. 229–257. ISSN 0269-0543.

Editorial board

President of Editorial Board

Prof. Ing. Miroslav Svatoš, CSc., Czech University of Life Sciences Prague, Czech Republic

Editorial advisory board

Prof. Dr. Ulrich Bodmer, Weihenstephan-Triesdorf University of Applied Sciences, Germany

Prof. Philippe Burny, Walloon Center for Agricultural Research, Gembloux, Belgium

Prof. Dr. Miklós Herdon, University of Debrecen, Hungary

Prof. Dr. Heinrich Hockmann, Leibniz Institute of Agricultural Development in Transition Economies, Halle, Germany

Prof. Ing. Jan Hron, CSc., DrSc., dr.h.c., Czech University of Life Sciences Prague, Czech Republic

Assoc. prof. Ing. Milan Kučera, CSc., Slovak University of Agriculture in Nitra, Slovak Republic

Prof. PhDr. Michal Lošťák, CSc., Czech University of Life Sciences Prague, Czech Republic

Prof. Ing. Mansoor Maitah, Ph.D. et Ph.D., Czech University of Life Sciences Prague, Czech Republic

Prof. Ing. Zuzana Pálková, Ph.D., Slovak University of Agriculture in Nitra, Slovak Republic

Assoc. prof. Ing. Ivana Rábová, Ph.D., Mendel University in Brno, Czech Republic

Ing. Helena Řezbová, Ph.D., Czech University of Life Sciences Prague, Czech Republic

Derek Shepherd, BSc, MSc, MTS, Plymouth University, Plymouth, United Kingdom

Prof. RNDr. PhDr. Antonín Slabý, CSc., University of Hradec Králové, Czech Republic

Assoc. prof. Ing. Pavel Šimek, Ph.D., Czech University of Life Sciences Prague, Czech Republic

Executive board

George Adamides, Ph.D., Agricultural Research Institute, Nicosia, Cyprus

Prof. J. Stephen Clark, Ph.D., Dalhousie University, Halifax, Canada

Prof. Ing. Lukáš Čechura, Ph.D., Czech University of Life Sciences Prague, Czech Republic

Prof. Ing. Luboš Smutka, Ph.D., Czech University of Life Sciences Prague, Czech Republic

Assoc. prof. Ing. Jiří Vaněk, Ph.D., Czech University of Life Sciences Prague, Czech Republic

Prof. Krzysztof Wach, Ph.D., Cracow University of Economics, Poland

Executive and content editors

Ing. Hana Čtyrká, Czech University of Life Sciences Prague, Czech Republic

Ing. Eva Kánská, Czech University of Life Sciences Prague, Czech Republic

Agris on-line Papers in Economics and Informatics

The international reviewed scientific journal issued by the Faculty of Economics and Management of the Czech University of Life Sciences Prague.

<http://online.agris.cz>

ISSN 1804-1930