



AgEcon SEARCH
RESEARCH IN AGRICULTURAL & APPLIED ECONOMICS

The World's Largest Open Access Agricultural & Applied Economics Digital Library

This document is discoverable and free to researchers across the globe due to the work of AgEcon Search.

Help ensure our sustainability.

Give to AgEcon Search

AgEcon Search
<http://ageconsearch.umn.edu>
aesearch@umn.edu

*Papers downloaded from **AgEcon Search** may be used for non-commercial purposes and personal study only. No other use, including posting to another Internet site, is permitted without permission from the copyright owner (not AgEcon Search), or as allowed under the provisions of Fair Use, U.S. Copyright Act, Title 17 U.S.C.*

TB 1429 (1971)

USDA TECHNICAL BULLETINS

UPDATA

THE THERMOLOGY OF WINTERING HONEY BEE COLONIES

OWENS, C. D.

1 OF 1

START

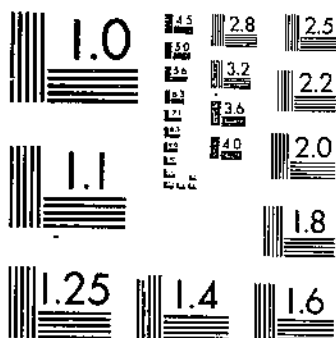

MICROCOPY RESOLUTION TEST CHART
NATIONAL BUREAU OF STANDARDS-1963-A

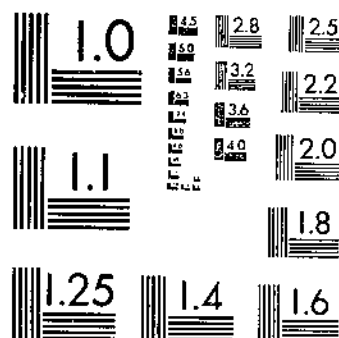

MICROCOPY RESOLUTION TEST CHART
NATIONAL BUREAU OF STANDARDS-1963-A

R630
US3-1
#1429

THE THERMOLOGY OF WINTERING HONEY BEE COLONIES

Technical Bulletin No. 1429

RECEIVED
JAN 10 1950

Agricultural Research Service
UNITED STATES DEPARTMENT OF AGRICULTURE

CONTENTS

	Page
Climatic conditions	2
Correlation of hive temperatures with colony cluster	3
Seasonal change in cluster	5
Temperature effects on cluster	8
Effects of entrance location on cluster	16
Effects of temperature on volume change	16
Population change versus time	17
Maximum temperature in cluster	19
Unusual cluster shapes	19
Refrigerated colony studies	22
Summer test	22
Winter test 1	23
Winter test 2	25
Winter test 3	25
Summary	31
Literature cited	32

THE THERMOLOGY OF WINTERING HONEY BEE COLONIES¹

By CHARLES D. OWENS, *Agricultural Engineering Research Division,*
Agricultural Research Service

A colony of honey bees (*Apis mellifera* L.) does not hibernate in winter. The bees form a cluster, clinging tightly together on the combs in the hive. The outer bees form an insulating shell that prevents excessive loss of heat. Within the cluster the warmth permits normal cluster activity such as rearing the young and consuming food. However, the precise nature of the cluster, its temperature, size, movement in response to external temperature, and ability to survive extreme cold for extended periods have not been investigated in detail. Such information is of economic value to beekeepers and of interest to bee scientists and other insect behaviorists.

Some cluster temperatures within wintering colonies have been reported by Büdel and Herald (3, pp. 115-180), Corkins (4), Lavie (5), Simpson (7), Vansell (8), and Wilson and Milum (9).¹ Most of these workers used small hives of bees for their studies. Büdel (1, 2) worked mostly with hand-constructed straw baskets or "skeps." These reports do not portray clearly a normal colony wintering in a full-size Langstroth-type movable-frame hive in the United States. Wilson and Milum used such a hive, but their recorded temperatures at a relatively few locations in the cluster do not present a complete cross section of the hive. Büdel found that 3 days were required for the clustered bees to return to normal after being disturbed. Obviously then for extensive and accurate temperature determinations to be

made within or near the cluster in winter, the use of numerous remote sensing elements or thermocouples is essential.

The treatments described here include (1) the colony in the unprotected hive, referred to as the check colony; (2) the colony in the hive wrapped with insulation and building paper, referred to as the packed colony; and (3) the colony in the hive held at 40° F. by a tape heater, referred to as the tape colony. Details of treatment and equipment have been reported (6).

The results of this study are based on a total of 1,200,000 temperature readings made from 1,600 to 2,000 thermocouple installations. The readings revealed the cluster reaction to change in outside temperature, the change in size and shape of the cluster during the winter, and the area of the cluster in which the brood developed. Some colonies were placed in a refrigerator to get better data on colony reaction to low temperature.

All hives used for this study were three hive bodies high. The bodies were 20 inches square and 6 $\frac{5}{8}$ inches deep. There was a 1-inch entrance hole in the center body and a 3- by 3 $\frac{3}{8}$ -inch entrance at the bottom board. The hives all faced south, and the combs were numbered from west to east.

Diagrams were made to illustrate the various cluster changes. Most of them present two views—a vertical cross section of the frames, combs, and bees 10 inches from the hive front and a vertical longitudinal view in interspace 6, 13 $\frac{3}{8}$ inches west of center.

All tests were conducted at Madison, Wis., from December 1 to March 31 for 5 years.

¹Italic numbers in parentheses refer to Literature Cited, p. 32.

CLIMATIC CONDITIONS

The mean outside temperature during the five winters of tests was 24.5° F. The lowest outside temperature recorded was -20° on January 29 and 30, 1951. There was generally a cold spell in mid-December, and the last part of January was always cold. A warming trend occurred throughout March. Although bees are

often kept in areas colder than Madison, the reactions of the colony to the outside temperature should be similar. Figure 1 shows the mean monthly and daily temperatures for the 4 months. These graphs can readily be compared with those for other areas to determine the wintering conditions.

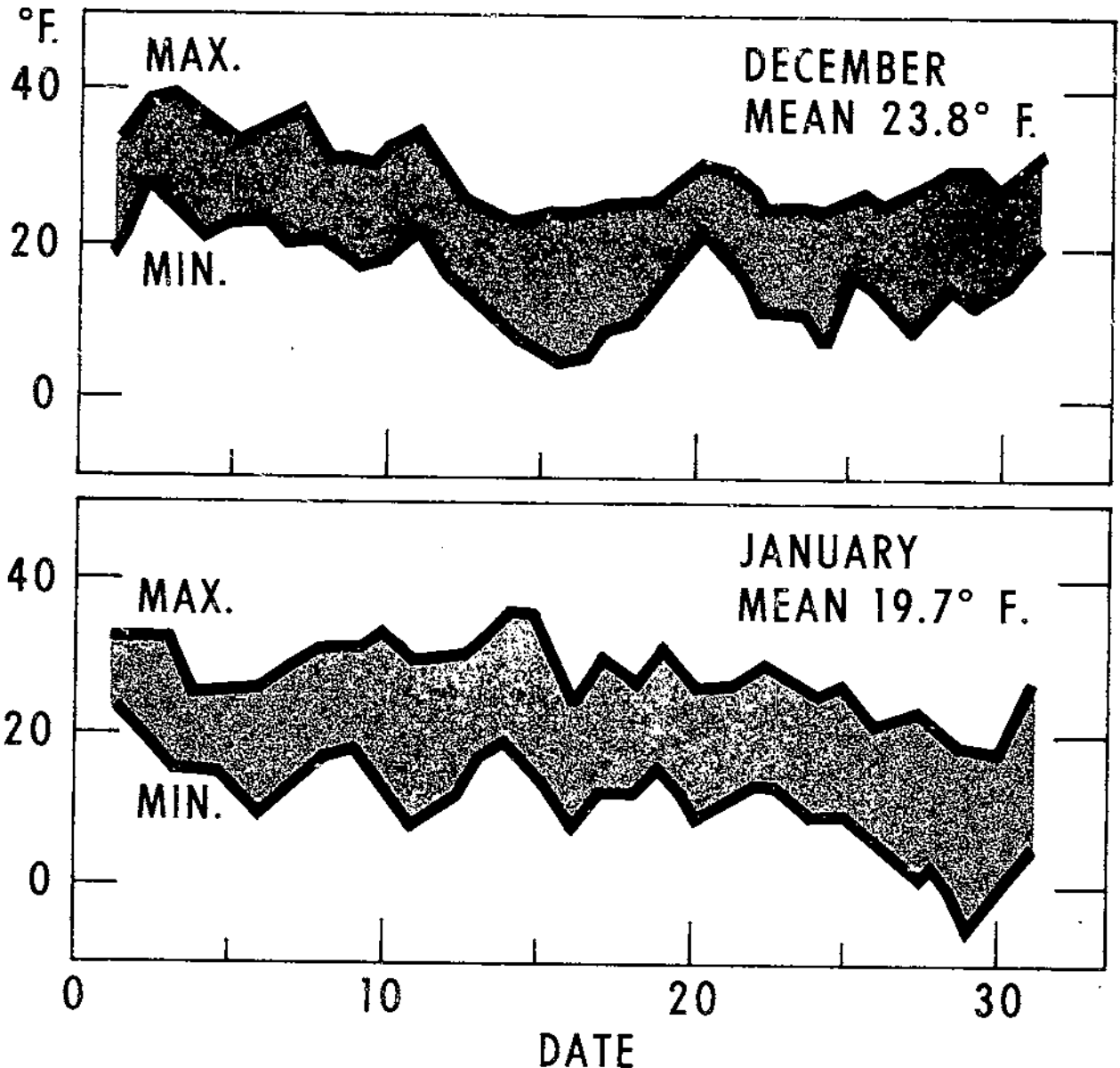

FIGURE 1.—Mean of 5 years' monthly and daily (maximum and minimum) temperatures during test period at Madison, Wis.

CORRELATION OF HIVE TEMPERATURES WITH COLONY CLUSTER

To correlate temperature readings taken throughout a hive with colony cluster location and composition, a normal colony was prepared in the following manner. Two hive bodies, each $6\frac{5}{8}$ inches deep and 12 frames wide, were each

equipped with 192 thermocouples in the interspace between combs 5 and 6. There were 12 rows of thermocouples with 32 in each row. The rows were $1\frac{1}{4}$ inches apart and the thermocouples were one-half inch apart in the

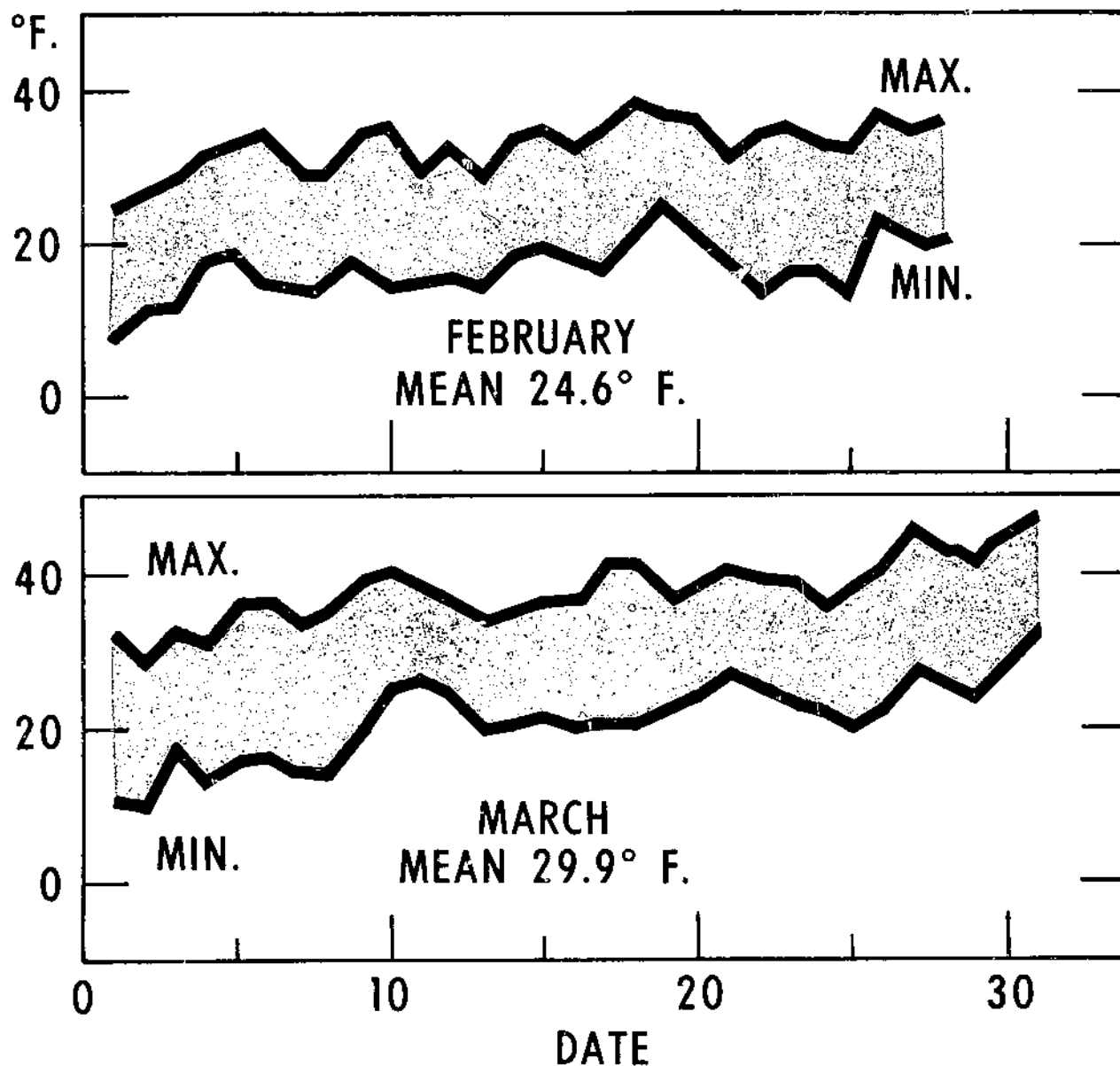

FIGURE 1.—Continued.

row. They were attached to a recording instrument so the temperatures could be determined without disturbing the colony. Then a normal colony, complete with combs of honey, brood, bees, and a queen, was transferred into this prepared hive, where it was left undisturbed for several weeks to adjust to its new domicile.

One day when it was 7° F. outside, the temperatures at all thermocouples were recorded. They ranged from 14° to 94°. The colony was killed with cyanide and temperatures were recorded as it died. There was no measurable increase in temperature, indicating that the cluster did not break up or move. The combs were carefully removed and the location of the bees and brood on all frames was recorded.

The cluster covered part of seven combs in the top body and extended a little below the

top bar on six combs in the bottom body. The center of the cluster was located between the sixth and seventh combs. Brood of various ages was on both combs facing the thermocouples. Comb 5 had various ages of brood on the side next to the thermocouples, whereas comb 6 had a scattered pattern of brood in all stages and had bees in the cells along the densely populated area of the cluster.

The combined brood location, bee location, and temperatures for the interspace prior to killing the bees are given in figure 2. For clarity, alternate temperature readings are shown. The location of the brood, its stage of development, and its boundary temperatures are shown in an enlarged view of the brood area (fig. 3).

Figure 2 shows that the temperature at the

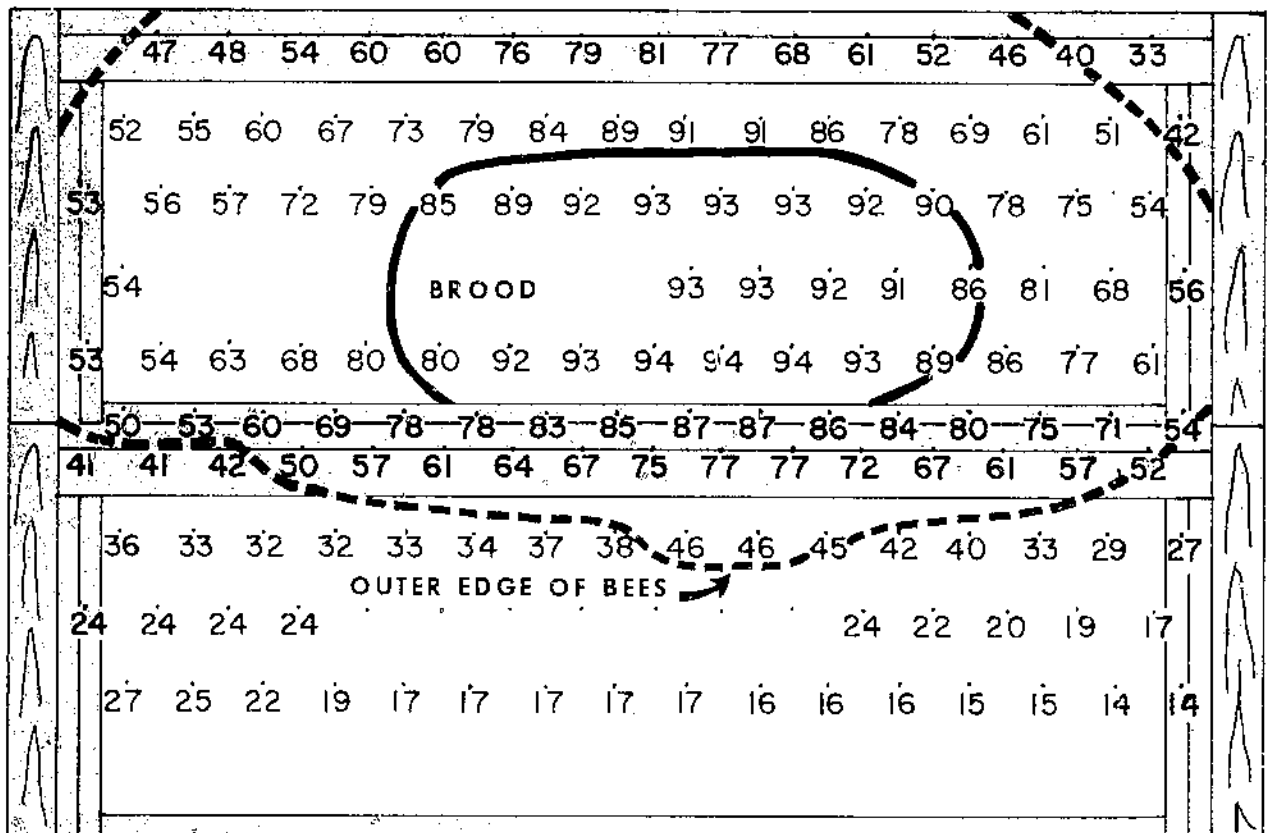

FIGURE 2.—Temperature readings (° F.) and brood and bee location one comb west of center of cluster at outside temperature of 7°.

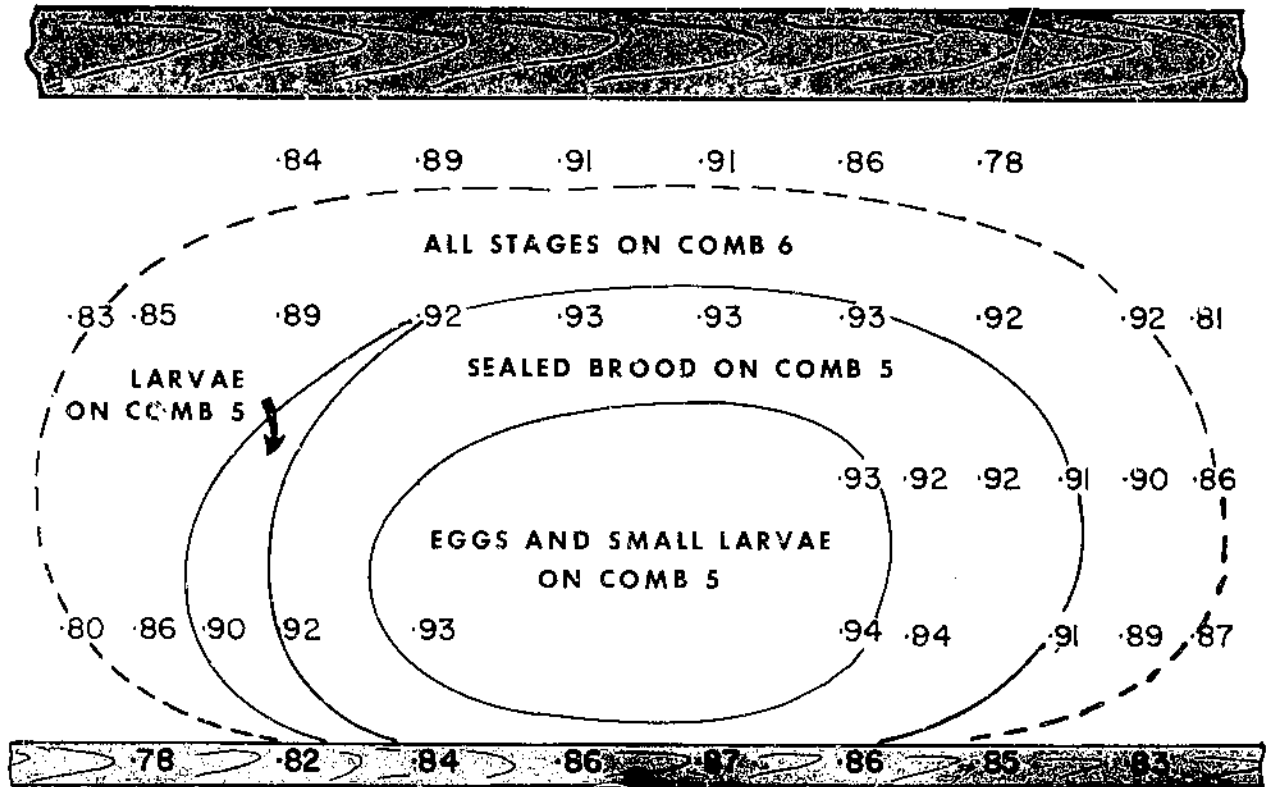

FIGURE 3.—Enlarged view of brood area in figure 2, showing composition in relation to temperatures ($^{\circ}$ F.).

outer edge of the cluster was about 44° F. Since the bees on the outer edge were facing into the cluster, this temperature was measured at the abdomen of the outermost bees. The bees were densest just inside this outer edge, where the temperature was 55° to 56° (not shown on diagram). They were in all empty cells and as close together as possible in the interspaces. Temperatures of 92° to 94° were recorded at all locations where brood was on both sides of the thermocouple, but where brood was only on one side of the thermocouple, the range was 85° to 92° , depending on the stage of the brood.

Based on this study, the makeup of other clusters was illustrated with 44° , 60° , 76° , and 92° F. isotherms, or lines connecting points of equal temperature. The 44° isotherm represents the outer edge of the cluster and the 92° the brood location. The 56° and 80° isotherms would give a truer picture of the insulating shell, but in plotting the temperature, 56° was too close to the 44° and 80° too close to 92° for clarity in the illustration. The 60° and 76° isotherms were selected primarily because they give uniform spacing between the other two isotherms and represent the main part of the insulating shell.

SEASONAL CHANGE IN CLUSTER

In the fall all colonies were arranged with the cluster in the center body. The top body contained most of the winter honey supply. In

January the clusters moved upward until they were occupying the top body and part of the second body. The cluster was smallest at this

time. In late January, brood rearing was started and the size of the cluster increased.

Sun radiation evidently affected cluster location. The cluster was always south and generally slightly west of the hive center. The clusters of the check colonies were not so close to the upper entrance as the other clusters. The upper entrance permitted the bees to leave the hive more easily during warm, sunny days than if they had only a bottom entrance.

Figure 4 illustrates the movement of the cluster in the three treatments from December to March. Each illustration is the mean of all colonies for each treatment on the first week of each month for 5 years. The location where brood was known to exist is shown only in the March diagrams.

The distance between the 44° and 60° F. isotherms shows the major effect of the treatment on the cluster. The check colonies have the least distance and therefore would have the tightest insulating shell. Since all colony populations were nearly equal, the distance between isotherms would give bee density or compactness. The January cluster usually had the smallest insulating shell. The tape colonies had the loosest insulating shell at all times. There was little difference in compactness of cluster in the tape and packed colonies.

The brood of the check colonies was more centered in the hive than the brood of the other treatments. The March data show the relationship of brood to treatment near the end of the test period. Brood volume² in the check colonies was the smallest and that in the packed colony was the largest. In the tape colonies heat did not improve brood production over that in the packed colonies. For further information on the relationship of brood production to treatment, see page 17.

Treatment had no effect on the manner in which the clusters moved nor on their location. The differences in cluster location and shape within treatments were as large as between treatments.

² See section on Effects of Temperature on Volume Change.

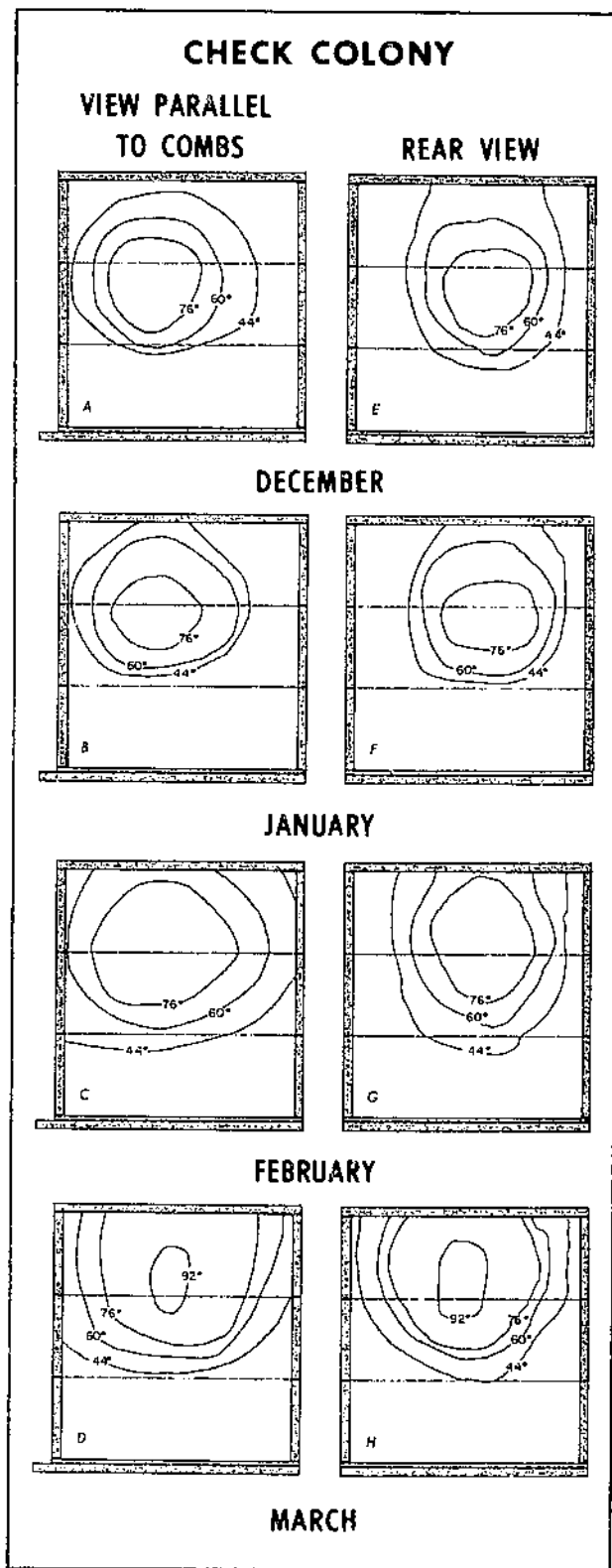

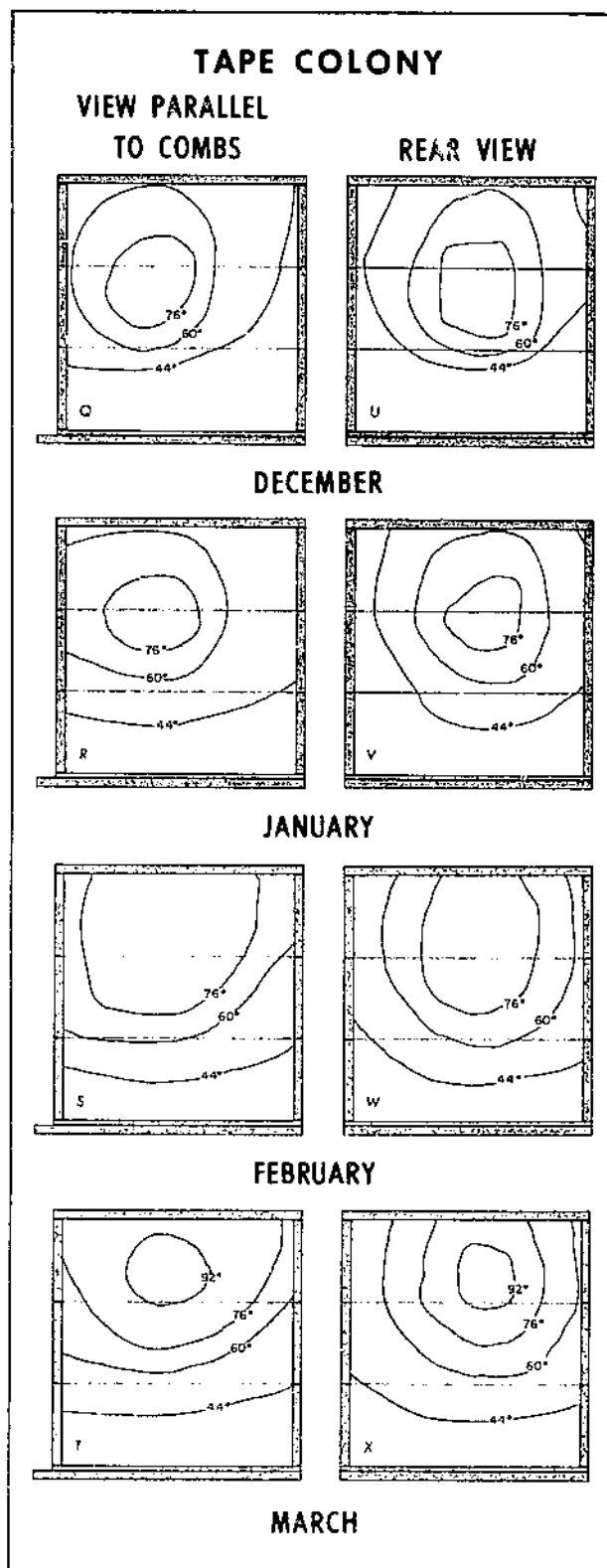
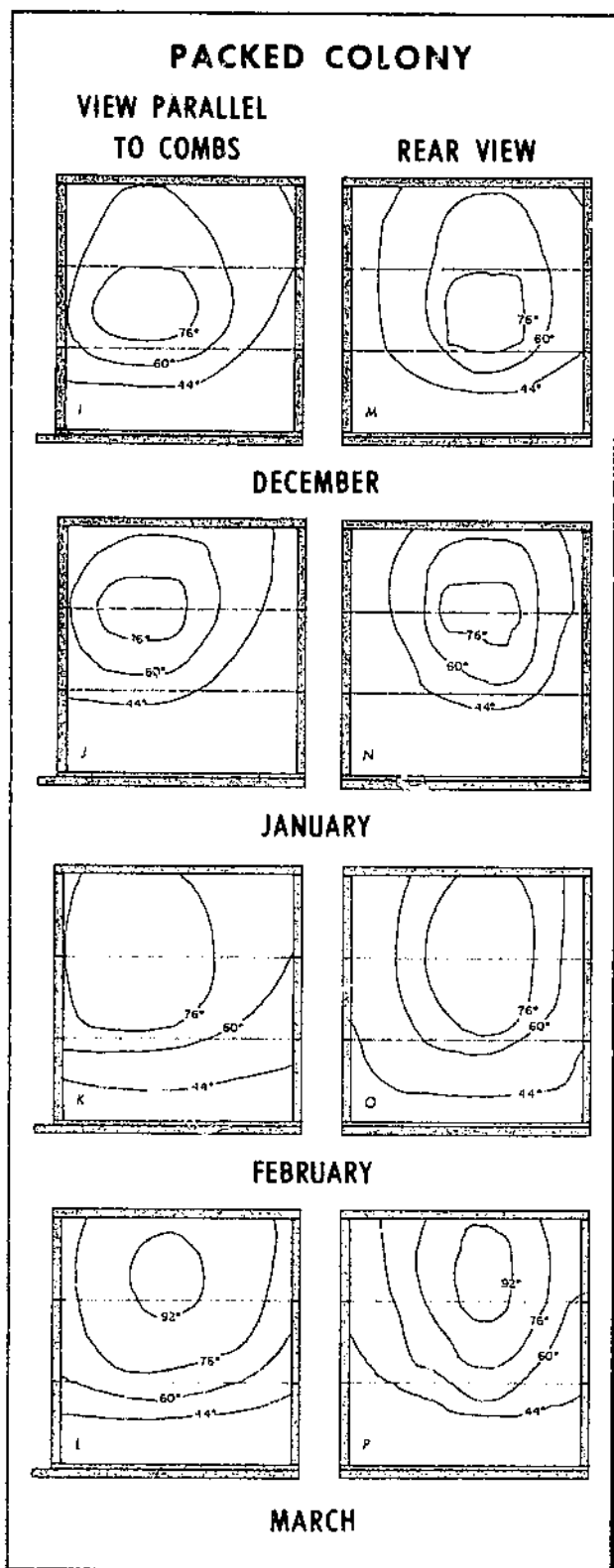

FIGURE 4.—Seasonal location and size of cluster in check, packed, and tape colonies, showing views parallel to combs and corresponding rear views.

TEMPERATURE EFFECTS ON CLUSTER

The temperature also affected the location and shape of the cluster. In the horizontal plane most of the clusters were located slightly to the southwest of the hive center. Their response to temperature fluctuations was modified by the various treatments.

Check Colonies.—Temperature affected the cluster in the check colonies more than in the other treatments. Below 25° F. the sun did not cause the cluster to move toward the hive front. Evidently at and below this temperature the heat loss from the wooden hive body was greater than the heat absorbed from the sun. Fluctuations in outside temperature caused changes in the space between the 44° to 76° isotherms. This space represents the insulating shell of the cluster, where apparently the population is constant. Therefore the bees per unit of space, or compactness of the insulating shell, must change. The area within the 76° isotherm is the active or heat-generating area of the cluster with a relatively low density of bees. The size of this area varied less with changing outside temperature than did the insulating shell. The isotherms on the bottom part of the cluster in figure 5, *A* and *B*, illustrate this change.

The cluster contracted during the low temperatures early in the morning or at night. The 44° F. isotherm in the parallel views illustrates this best. In the daytime the isotherm touched the back and front of the hive but not at night. There was less change in isotherms laterally owing to the comb restriction. In figure 5, *A*, the temperature 3 inches below the 44° isotherm was 0°.

Prior to midnight on January 3 of the same year, the outside temperature was almost constantly 40° F. for 36 hours (fig. 6). After midnight the temperature steadily declined, reaching 0° at 0800 on January 5. On January 3 no temperature was under 46° in the colony and the highest was 90°. When the outside temperature reached 2°, the lowest hive temperature was 2° and the highest 89°. The insulating shell gradually became compacted and the cluster moved away from the front of the hive.

Although this colony reacted typically to the temperature changes, a very unusual movement was also recorded. On January 4 between 0700 and midnight when the outside temperature was between 2° and 9° F., the cluster moved sideways and down into the center body (fig. 6, *L, N, P*). Then it returned to its original location. Apparently it moved to obtain honey. This demonstrates how a strong colony can move its stores under low temperature conditions. Weaker colonies might starve with honey in the frame next to the cluster, because the bees are unable to generate enough heat to let the cluster spread over additional comb. Other cluster temperature records indicated similar movements, but insufficient readings prevented determining the extent of the movement.

Casual examination of the data might indicate that all cluster movements were due to outside temperature changes. But from closer study of the data taken during periods of relatively constant temperature, it was concluded that solar radiation markedly affected cluster movement. At a constant temperature the check colony cluster withdrew from the entrance and the side of the hive at night. Figure 7 shows a typical example of this change at a relatively warm winter temperature.

Figures 5 and 6 show that the distance between isotherms changes because of temperature. If the number of bees within the insulating shell remains constant, then the density of the bees must change. Also, as shown in figure 5, there is a large temperature change within a very short distance outside the cluster. This suggests that the airflow around the cluster was small.

Figure 8, *A*, shows how the temperature at six points through the bottom edge of the cluster varied with the outside temperature. At -8° F. the temperature differed by 47° in a $\frac{5}{8}$ -inch distance between 1C and 8T at the edge of the cluster, and at 20° the maximum difference between 2C and 3C was 8° in a 1-inch distance.

The points are plotted against time in figure 8, *B*, to show how these temperatures varied

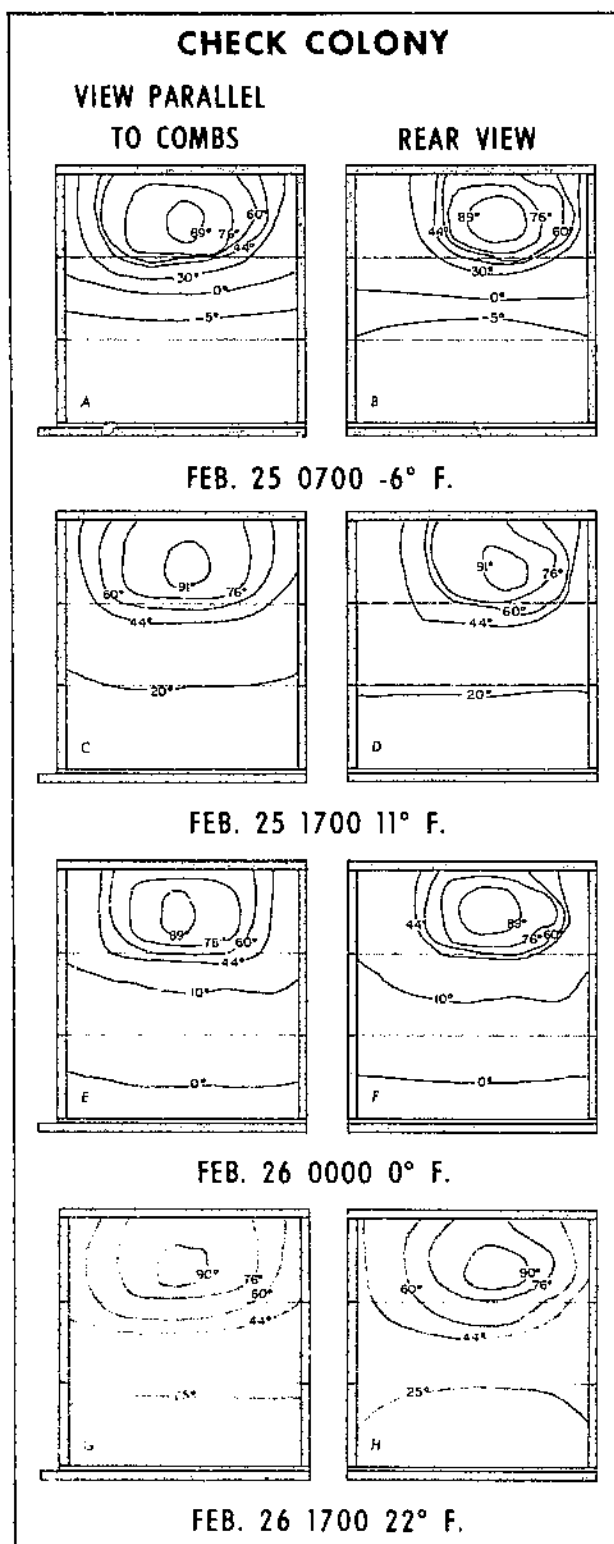

FIGURE 5.—Effect of outside temperature change on isotherms of check colony, showing views parallel to combs and corresponding rear views.

inside and outside the hive. The outer edge of the cluster is 44° F. At an outside temperature of 10° the cluster edge covered the top thermocouple in the center body, and at about 17° it covered the two top thermocouples. The location of the cluster's outer edge and the temperature outside the cluster change with outside temperature. Frequent temperature readings showed that the change in hive temperatures lagged behind the outside temperature by 1 to 2 hours. Normally no temperature in the check hives reached the daily maximum or minimum outside temperatures, but it fluctuated in accordance with them.

The 5-year tests of the check colonies showed that stronger colonies changed cluster location and size more than did weaker colonies. Weak clusters could not generate sufficient heat to move even during mild winter temperatures in Wisconsin.

Packed Colonies.—The mean temperature outside the cluster in packed colonies was 7° F. higher than in the check colonies. The cluster in the packed colonies changed shape and size as the outside temperature and solar radiation changed. Figure 9 shows a typical example of these changes.

The largest change took place between the 44° and 60° F. isotherms. Since the space between these isotherms is greater than in the check colonies, the compactness of the insulating shell was less. This is based on the assumption that the number of bees in each colony was nearly equal, which over the 5-year test period was correct. An examination of the higher temperatures recorded within the cluster showed that the maximum temperature within the cluster occurred when the outside temperature decreased. The volume inside the 76° isotherm decreased slightly with a lowering of temperature. At night the cluster withdrew slightly from the upper entrance. The change in cluster volume between day and night was less than that in the check colonies at the low temperatures, but volume was greater at outside temperatures over 30°.

Figure 10 shows the change in a packed colony for a 2-day period when the outside temperature was increasing. The cluster gen-

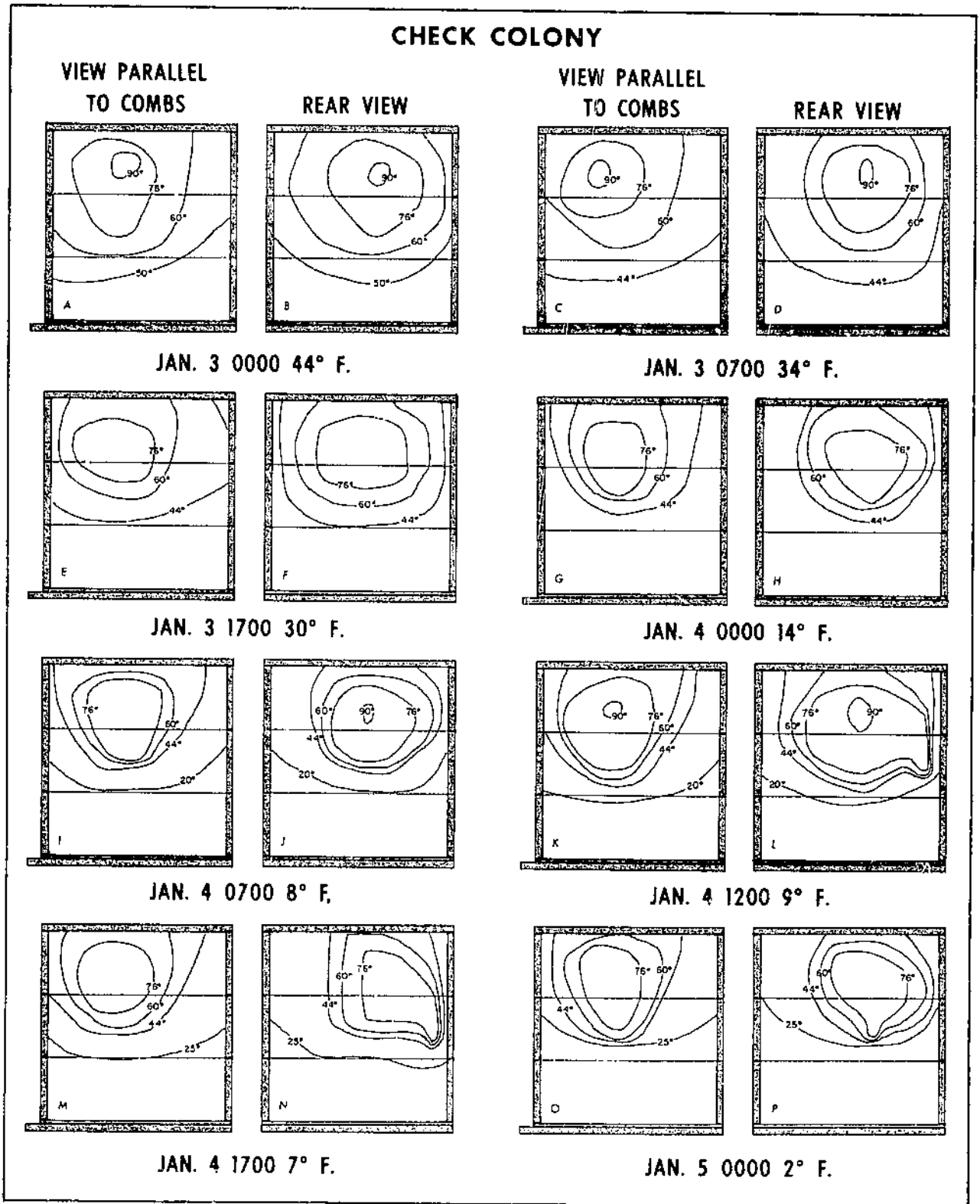

FIGURE 6.—Effect of drop in outside temperature on cluster movement of check colony, showing views parallel to combs and corresponding views at right angles from rear.

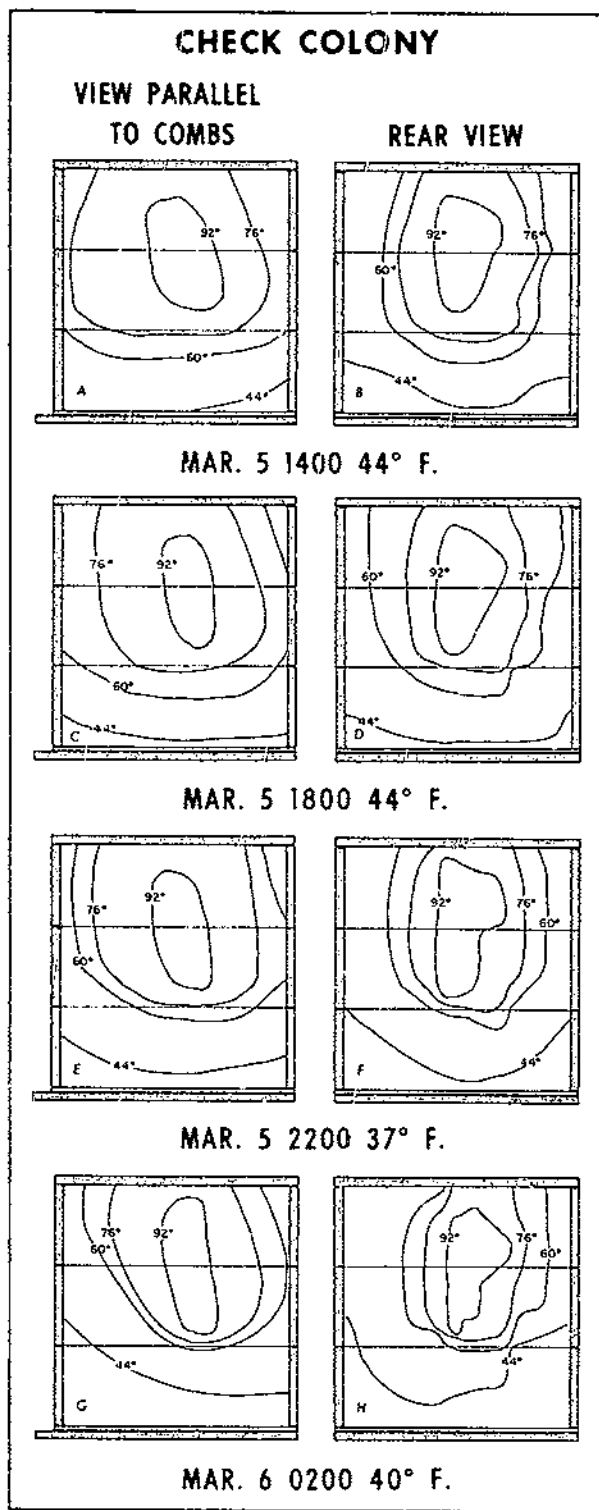

FIGURE 7.—Cluster movement of check colony during day and night with little or no change in outside temperature, showing views parallel to combs and corresponding rear views.

erates enough heat to warm the entire hive to over 40° F. when the outside temperature was over 30°. There was little effect due to solar radiation, but the 76° isotherm was farther away from the entrance at night.

Figure 11 shows that during a constant outside temperature the cluster changes only slightly between day and night. In this instance the cluster was very large because of the relatively warm temperatures, and the colony had brood in two bodies. However, no brood is shown in figure 11, A, because it was not in the plane of the diagram. Only a slight drawing away from the side walls at night was noted (fig. 11, G). The withdrawing of the cluster from the entrance in the check colonies was not observed in the packed colonies. The location of the cluster is southwest of the hive center, indicating an effect of solar radiation, although the insulation around the hive should have reduced this.

Analysis of readings taken during a 24-hour period shows that the temperature of the packed hives lagged behind that of the outside air for 6 to 8 hours. The total change in the hive temperature outside the cluster was only about one-third as great as that of the outside temperature.

Tape Colonies.—The lowest temperature recorded in the tape-heated hives with a 40° thermostat setting was 29° F. This occurred when the outside temperature was below 0°. The isotherms in the tape colonies were farther apart than in the packed colonies. The distance between the 44° and 60° isotherms suggests a very loose insulating shell. The changes in cluster size due to outside temperature were less marked in the tape colonies than in the packed colonies. At low nighttime temperatures the 44° isotherm near the hive entrance moved closer to the 60° isotherm. This would be a response to cold air at the entrance.

The change in cluster size due to night temperature is shown in figure 12. When the outside temperature was near 40° F., the cluster size varied considerably because the entire hive temperature permitted the bees to move about easily. Although the outside temperature change was small, there was a large change in the location of the 44° isotherm at

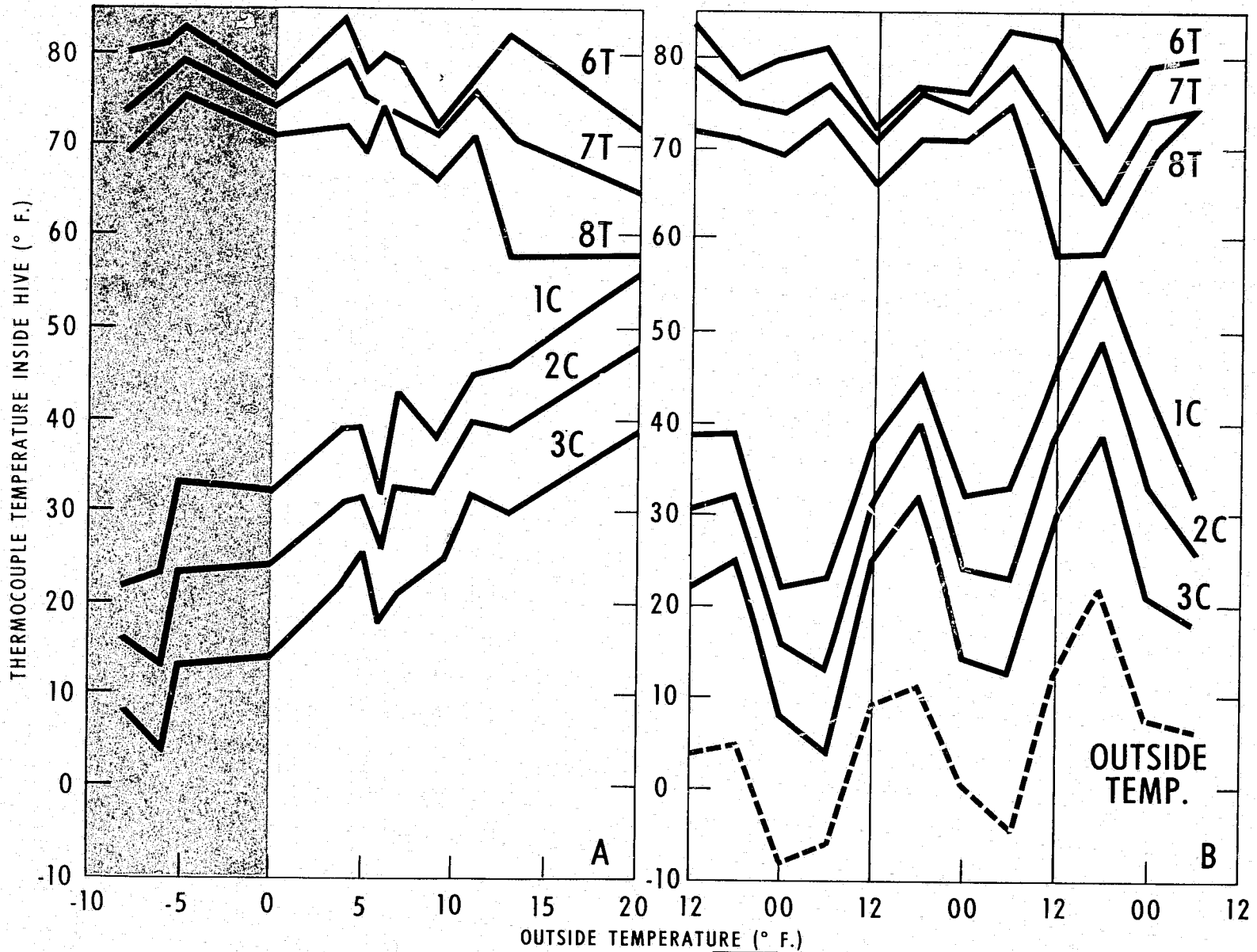

FIGURE 8.—Temperature variation in check colony versus outside temperature. (Thermocouple 8T is three-eighths inch above bottom edge of top body and 1C is one-fourth inch below top edge of center body; others are 1 inch apart in their respective directions.)

PACKED COLONY

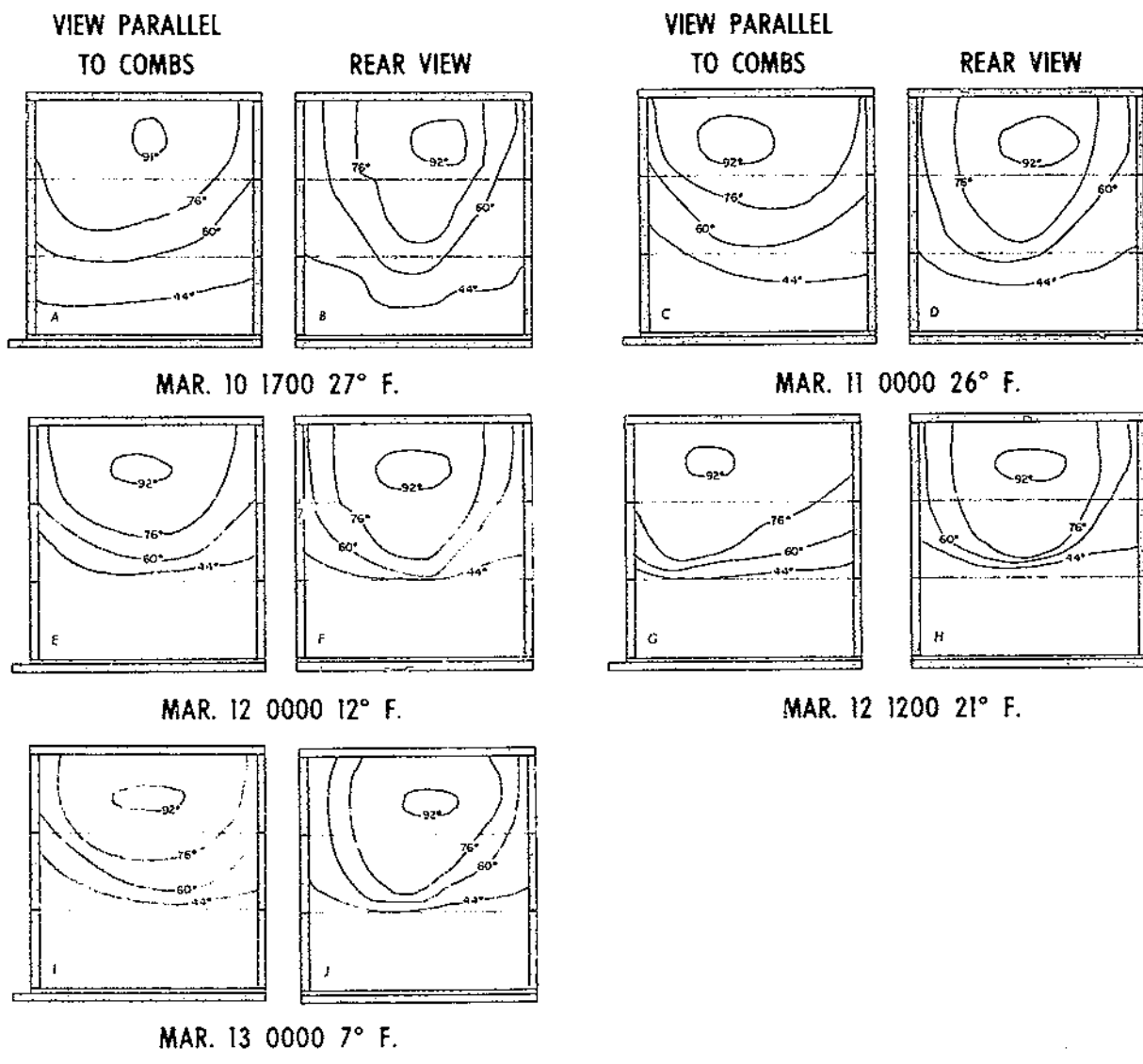

FIGURE 9.—Effect of lowering outside temperature on cluster movement of packed colony, showing views parallel to combs and corresponding rear views.

the hive entrance. However, the distance between the 60° and 76° isotherms did not change appreciably.

When the outside temperature decreased from 30° to 1° F., a large change occurred in the 44° isotherm at the entrance (fig. 13, A and G). Although there was an appreciable

change in the relative position of the 44° and some change in the 60° isotherm, the area within the 76° isotherm showed that the center of the cluster did not change in size. At a constant outside temperature the cluster position did not change between night and day in the tape colonies.

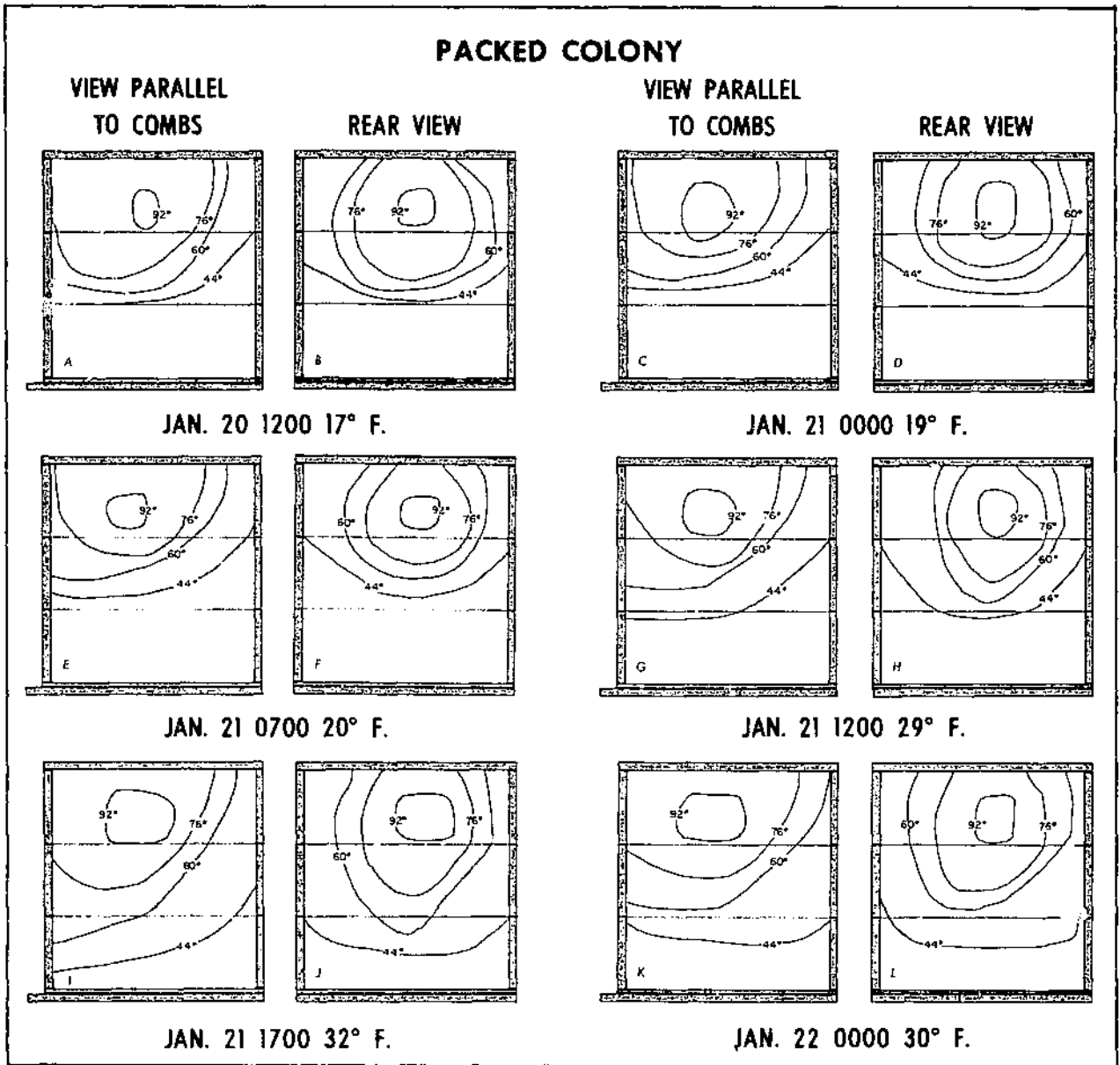

FIGURE 10.—Effect of rise in outside temperature on cluster movement of packed colony over 2-day period, showing views parallel to combs and corresponding rear views.

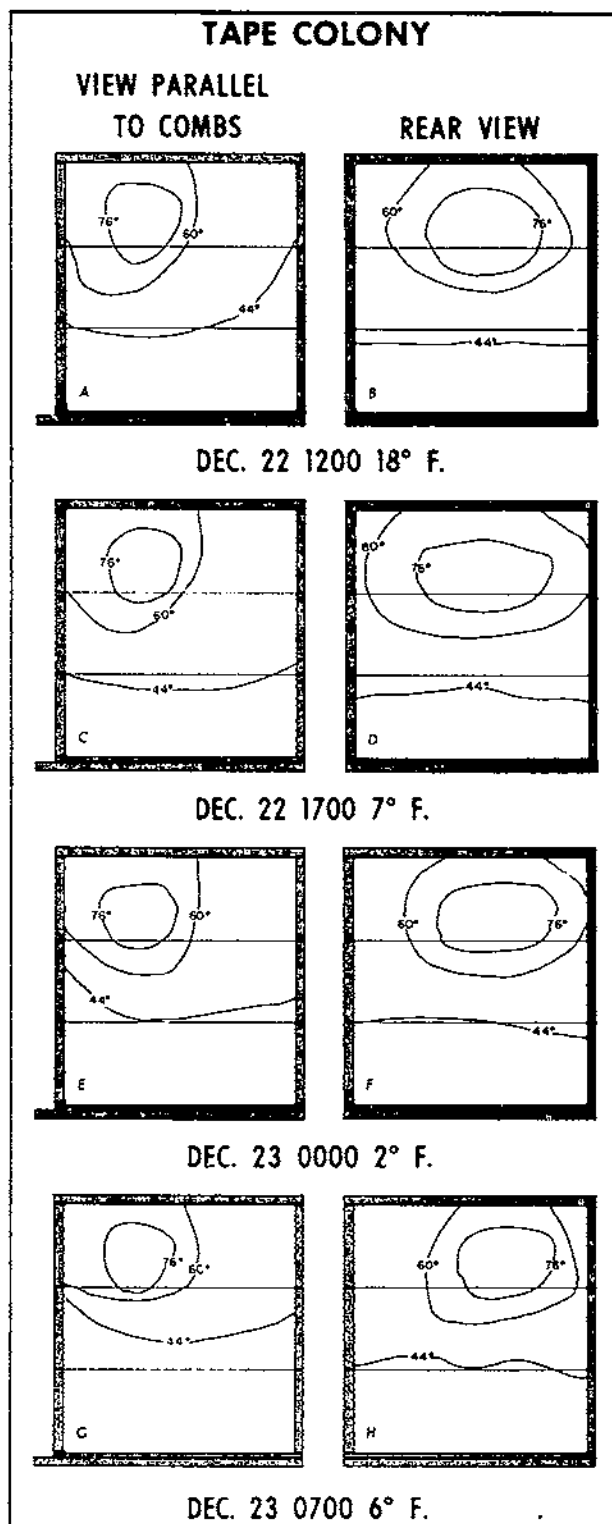
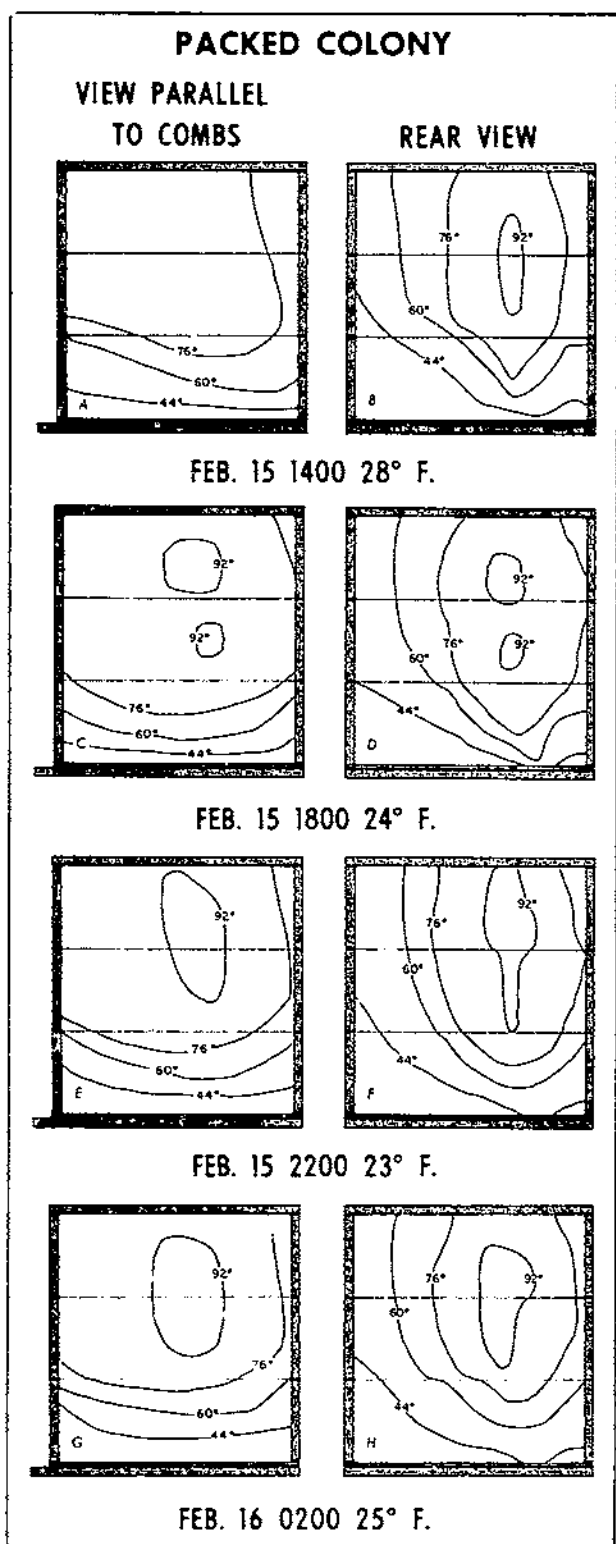

FIGURE 11.—Effect of constant outside temperature on cluster movement of packed colony, showing views parallel to combs and corresponding rear views.

FIGURE 12.—Effect of outside night temperature on cluster movement of tape colony, showing views parallel to combs and corresponding rear views. (No brood in parallel and rear views as it was not in the drawing plane.)

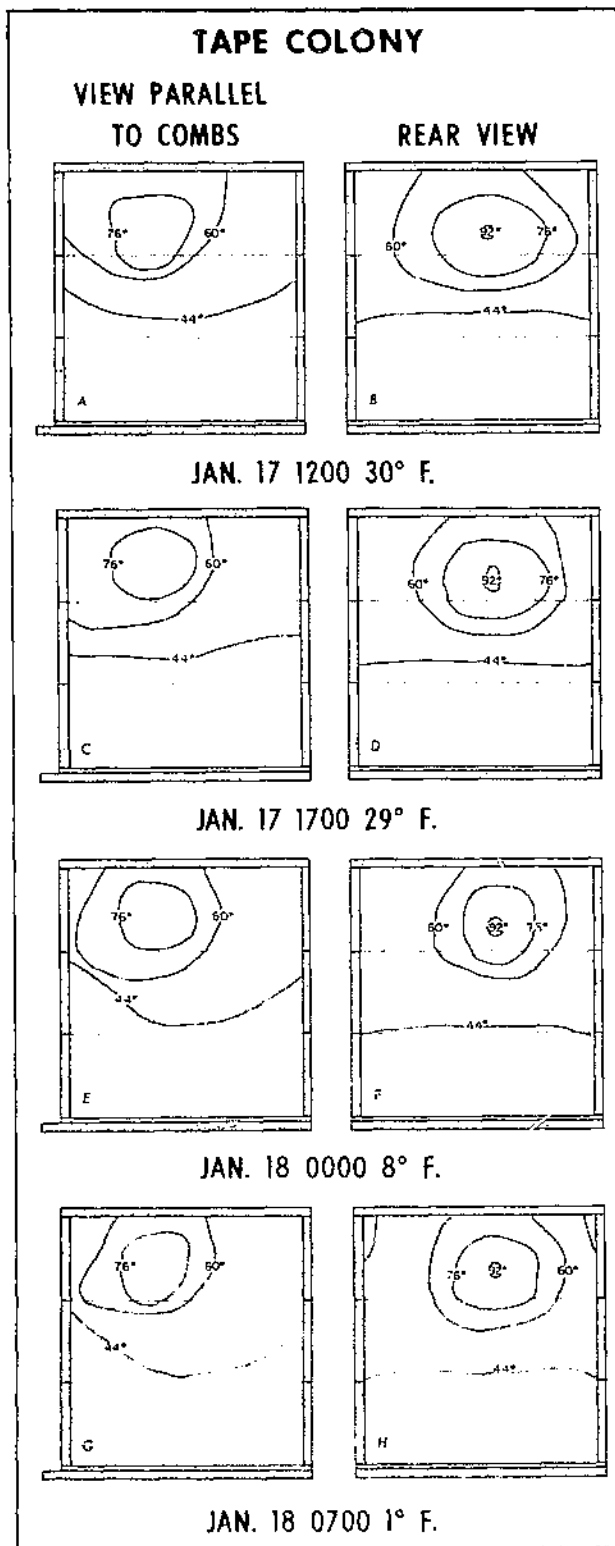

FIGURE 13.—Effect of drop in outside temperature on cluster movement of tape colony, showing views parallel to combs and corresponding rear views.

Effects of Entrance Location on Cluster

The bottom entrances were closed and the top entrances remained open on all colonies for a few days and then the openings were reversed. The bottom entrance had no effect on the reaction of the cluster because of temperature. Nor did the bottom entrance affect the temperature in the bottom body of the check or packed colonies. The tape colonies had a 2° F. rise in the bottom body when the bottom entrance was closed. When the top entrance was closed, the cluster moved closer to it and did not draw back at night as it did when it was opened. Except for temperature changes caused by the cluster movement, the temperature distribution in the hives was not altered by changing the entrances.

Although the effects of the outside temperature on the cluster were reduced when the top entrance was closed, the bees were prevented from leaving the hive on warm days. Periodical bee flights in winter seem to make for a healthier colony. Without an upper entrance the bees were confined to the hive most of the winter and thus their chance for winter survival possibly was decreased. The lower body of the unheated check and packed hives never warmed up enough to permit the bees to fly from the bottom entrance.

Effects of Temperature on Volume Change

The temperature data were plotted to scale in a plane parallel to the combs and in another vertical plane at right angle to the combs, as shown in previous diagrams. The total area within each isotherm and the horizontal and vertical dimensions of each plane were measured. The volume within each isotherm in cubic inches was then computed. The term "volume" as used here includes bees and comb enclosed by the isotherm. The 44° F. volume includes everything in the hive that is 44° or higher. The volume is calculated likewise for other temperatures used.

The ratios of the 44° to 60° F. volume, 60° to 76°, and 76° to 92° were compared. Only the 44° to 60° volume varied with temperature. Therefore this is the space that reflects the

temperature effect on the cluster. Although the other isotherms changed, they did not fluctuate directly with temperature; therefore they indicate the cluster size due to treatment and population. Since the populations over the years were about equal, the treatment contributed most to the cluster size.

A statistical analysis was made of the change due to outside temperature in the 44° F. volume for the three treatments. The data for analysis covered a 17-week period for each of the 5 years. They included the morning readings for all colonies with an outside temperature of 2° to 40°. The data showed that colonies receiving the same treatment responded the same in all years. Therefore all colonies of a treatment were used to determine the coefficients for the equation $y = ax + b$. Over this range of temperature the effect was linear and the regression equation for each treatment in the 44° volume is as follows:

$$\text{Check} = 8.14x + 98.7$$

$$\text{Packed} = 10.59x + 178.4$$

$$\text{Tape} = 5.42x + 343.7$$

x = outside temperature between 0° and 40°.

The change in the 44° F. volume per unit change in temperature of the packed and tape colonies is significantly different. The comparisons of the check to the packed or tape colonies were not significant. These regressions are limited to the specific test, but the change in size should hold for other years.

The statistical results bear out what was said about each treatment. The tape colonies had the largest cluster, and the packed colonies showed the greatest changes due to temperature. As years had no effect on the analysis, the number of bees in all colonies had to be nearly equal. The compactness or density of the bees in the cluster was greatest in the check colonies. At 40° F. the cluster size in the packed and tape colonies would be equal.

POPULATION CHANGE VERSUS TIME

As shown earlier, the best way to compare treatments is by the volume enclosed within an isotherm. Since the outside temperature primarily affected the 44° F. isotherm, fluctuations in the other temperature isotherms represent changes in cluster populations for the treatments.

The 60°, 76°, and 92° F. isotherm volumes were plotted for each year and for each colony against date. Each year the curves were similar in shape and all showed cyclical fluctuation in volume. Some of these fluctuations, like those at the 44° isotherms, were due to changes in the outside temperature. When these curves were adjusted for outside temperature, they still showed periodical changes in volume. Figure 14 shows the curves for the 60° and 92° volumes of all colonies for each treatment. The humps in the 60° lines would indicate a period of general change either to mild temperature or to short periods of brood rearing. Neither explanation is supported by the data and the humps remain unexplained.

Cluster populations continued to decrease during December and reached a minimum around mid-January, when they started to in-

crease as brood emerged. The greatest increase took place in April. The rate of brood rearing based on volume of the isotherm at 92° F. is shown in figure 14.

The volume of brood in the check colonies was lower than in the other colonies until April, then during April it increased rapidly. By the end of April the brood volume in the check colonies was as large as it was in the other treatments. Pollen supplement was fed to all colonies each year in early March. This caused an increase in brood rearing in all treatments, but the check colonies' increase was the least. The difference in brood rearing between the packed and tape colonies was small. The packing aided in early brood buildup, but adding heat to packed hives (tape colonies) did not increase the buildup over the packed colonies. When the weather warmed in late March, the brood in the check colonies increased much more than in the other treatments.

An analysis was made of the effect of treatment for all years on the brood nest based on the volume size enclosed by the 92° F. isotherm. The treatment variations in cubic inches as

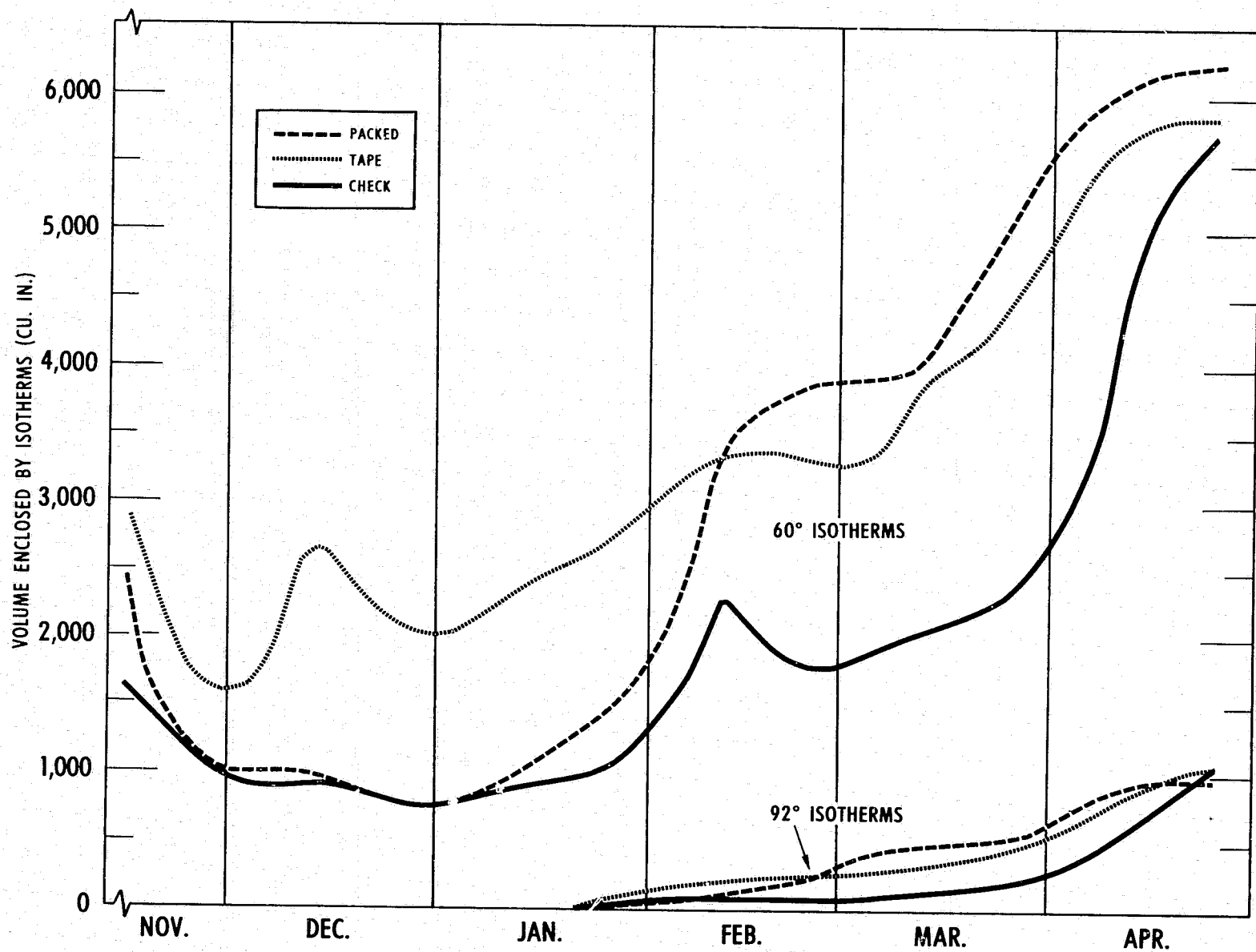

FIGURE 14.—Effect of date on changes in 60° and 92° F. isotherm volumes for each treatment. Each line represents mean of all colonies for that treatment.

they deviated from the mean of the treatments were as follows: Check —286, packed +158, and tape +126. There was a significant difference at the 5-percent level between the check colonies and the others, but there was no significant difference between packed and tape colonies. The results are significant for the specific years of the test and should be applicable for any future year.

MAXIMUM TEMPERATURE IN CLUSTER

The temperature at the center of the cluster varied throughout the season. It was lowest in the fall. The lowest temperature recorded within a cluster was 82° F. The brood nest temperatures usually were higher in the packed and tape than in the check colonies. Table 1 shows the highest temperatures recorded in the clusters and the number of thermocouples with readings over 92°. The packed colony on March 13 had 74 out of 112 thermocouples with readings over 92°. Since the high temperatures were between combs 4 and 5, they only show in the rear view in figure 15, B.

The outside temperature for the 24 hours previous had varied between 24° and 32° F. Therefore the high internal temperature was not caused by a high external temperature. In many instances when more than a 15° increase occurred above the normal daily high temperature, a cluster expansion with high temperatures in the cluster was observed on that date, as shown in table 1 for December 3.

The tape colony on February 25 had a 100° F. temperature recorded in the brood area (fig. 15). The cause of the high temperature in the hive was not determined since the outside temperature was relatively uniform and moderate.

The highest temperature recorded in any cluster occurred on January 3, when a small check colony had a temperature of 105° F. The outside temperature at that time was 8°. The population of this colony was smaller than the others in the fall, but it maintained a higher

More brood was reared in the packed and tape colonies before April 1. Heat alone did not stimulate brood rearing. Generally at Madison after the start of warm weather and food storage, the population in the check colonies can catch up with the other colonies by the time of the main honey flow. All brood volumes varied with time and were probably due to fluctuation in brood rearing.

temperature in the center area throughout the season. Why such abnormally high temperatures were created was not determined.

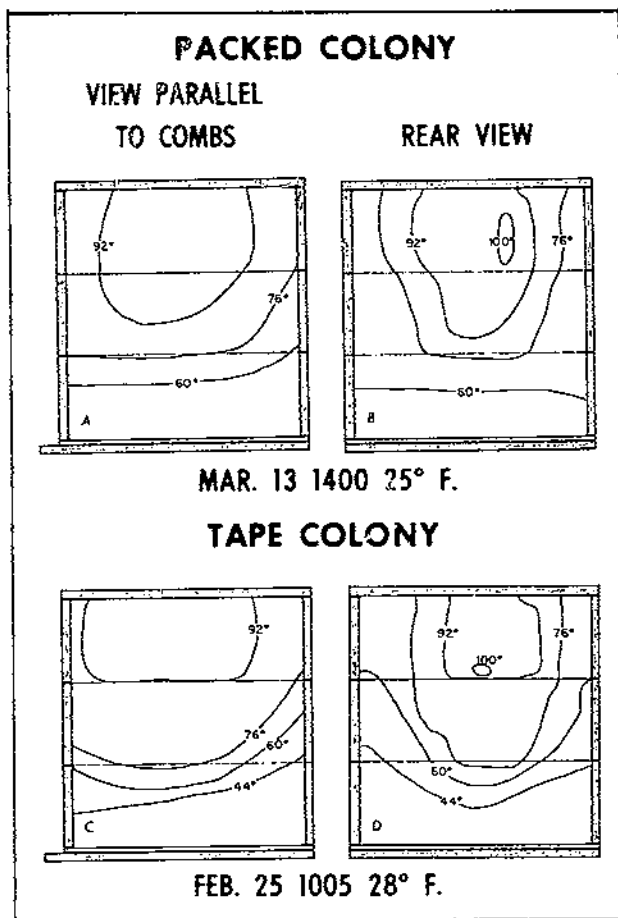

FIGURE 15.—High temperatures in clusters of packed and tape colonies, showing views parallel to combs and corresponding rear views.

UNUSUAL CLUSTER SHAPES

The cluster shape is usually ellipsoidal. The shape changes most when the cluster is relocating or apparently moving honey stores in the

hive (fig. 6, L, N, P). Sideways movement of the cluster or probable transfer of stores was observed on several occasions during the 5-

TABLE 1.—Maximum temperatures and number of thermocouples (TC) with readings over 92° F. in cluster for 3 treatments during season

Date	Air temperature	Check, 176 TC		Packed, 112 TC		Tape, 176 TC	
		Highest temperature	TC over 92°	Highest temperature	TC over 92°	Highest temperature	TC over 92°
	° F.	° F.	Number	° F.	Number	° F.	Number
November:							
11.....				88.....		92.....	1
23.....	28	84.....		85.....		87.....	
26.....	30	88.....		82.....		86.....	
29.....	42	94.....	6	89.....		88.....	
December:							
3.....	50	96.....	28	96.....	6	94.....	20
6.....	41	93.....	2	92.....	1	93.....	2
10.....	30	89.....		88.....		82.....	
20.....	22	83.....		89.....		88.....	
January:							
4.....	24	90.....		90.....		90.....	
10.....	28	91.....		92.....	1	91.....	
14.....	29	92.....	3	92.....	1	91.....	
17.....	38	92.....	1	92.....	2	90.....	
21.....	26	91.....		93.....	6	89.....	
24.....	-2	90.....		92.....	2	91.....	
28.....		90.....		92.....	4	92.....	7
31.....	35	92.....	2	92.....	1	91.....	
February:							
5.....	21	91.....		92.....	2	94.....	14
7.....	32	92.....	2	93.....	6	91.....	
11.....	33	92.....	6	94.....	10	95.....	42
14.....	21	91.....		93.....	4	93.....	22
18.....	25	92.....	8	92.....	8	93.....	16
21.....	27	91.....		92.....	7	94.....	19
25.....	24	93.....	17	95.....	38	100.....	43
28.....	30	93.....	27	96.....	52	95.....	44
March:							
3.....	28	93.....	22	94.....	43	93.....	16
6.....	24	91.....		96.....	67	92.....	20
13.....	24	93.....	21	100.....	74	98.....	61
17.....	32	93.....	16	95.....	57	93.....	27
20.....	38	93.....	20	96.....	67	96.....	53
24.....	24	92.....	6	91.....		95.....	35
31.....	50	91.....		95.....	53	95.....	60
April 15.....	50	92.....	11	93.....	50	93.....	72

year study. The cluster shape did not materially change in the vertical plane.

Two of the most extreme deviations in shape

are illustrated to show what can occur within a hive during the clustering period (fig. 16, A, B, and C). On November 14 the isotherms in the tape colony heated by thermotape to 35° F. indicated that the cluster was of uniform shape and located in the center of the hive. On November 23 when the outside temperature was 24°, the isotherms, as viewed from the rear of the hive, indicated that the cluster had divided, apparently to rearrange its stores. By November 29 it had returned to its former shape and location. The cluster was large, as shown by the depth of the 44° isotherm. Because of its size and aided by the heater it was able to divide and still maintain the required temperatures.

Normally the cluster temperatures allowed a smooth curve to be drawn connecting points of equal temperature. However, a colony heated to 40° F. during December had a very irregular shape at the 76° isotherm (fig. 16, D, E, F), and for part of the month the 60° isotherm was also irregular. In mid-December the warmer area of the cluster in the center body appeared to be splitting. In the last part of December this area of the cluster began moving into the top super, and this irregular shape remained until the cluster completed its move into the top super. Afterward it maintained a normal shape for the rest of the year. Views parallel to the combs showed no irregular shapes.

These illustrations show that a colony can and does make short-term shifts in the hive, probably to move honey into the clustering area. However, both of these incidents occurred in well-populated hives that could generate the heat to warm the area into which they were moving. Small clusters covering only the depth of the frame could move only under very mild temperatures.

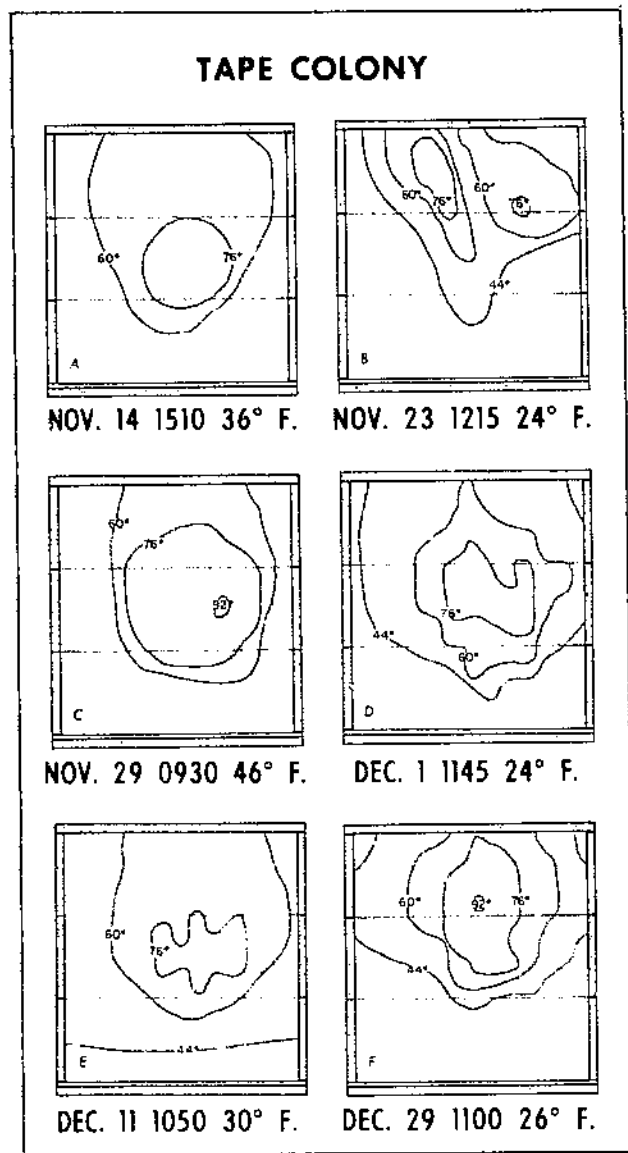

FIGURE 16.—Unusual cluster shapes of tape colony, showing rear views.

REFRIGERATED COLONY STUDIES

A special refrigeration unit was built that could hold two colonies of bees and could maintain a temperature as low as -45° F. It was equipped with two thermostats and a time clock to give two cabinet temperatures for each day. An electric heater was used to increase the cabinet temperature to the higher daily setting. A $\frac{3}{4}$ -inch tube extended from each hive entrance to the outside to provide ventilation. A heater was applied to each tube to keep it free of ice. Otherwise the moisture in the tube would condense, freeze the tube shut, and suffocate the colony.

Summer Test

Two check colonies were placed in the refrigerator on July 30. Both had a considerable amount of brood in the bottom and center supers. The cabinet was held at 0° F. for 4 days, then lowered to -45° for the remainder of the test. A period of 18 days was required after the colonies were placed in the cabinet before they formed a tight cluster (fig. 17). One colony was in the chamber for 41 days with a mean temperature of -28.8° and the other colony for 35 days at -26.8° . Each colony was removed when the temperature readings showed that only a small cluster remained. Both were in a weakened condition when removed and were 100 percent infected with nosema disease.

When the two colonies were held at -45° F., there were several 90° to 92° readings in the center of the cluster. When the cabinet temperature was at 0° , these cluster temperatures were 86° . The bees apparently were generating heat to maintain the large cluster volume at the low air temperatures by heating the center area to over 90° . A period of 14 days at -40° cabinet temperature was required to cool the bottom super to 40° and 3 more days were required to cool the same area to -30° . When the brood rearing stopped, the clusters decreased rapidly in size. The cluster had moved to the top and center super within 18 days after the thermostat in the cabinet was set at -40° .

These colonies might have fared better had

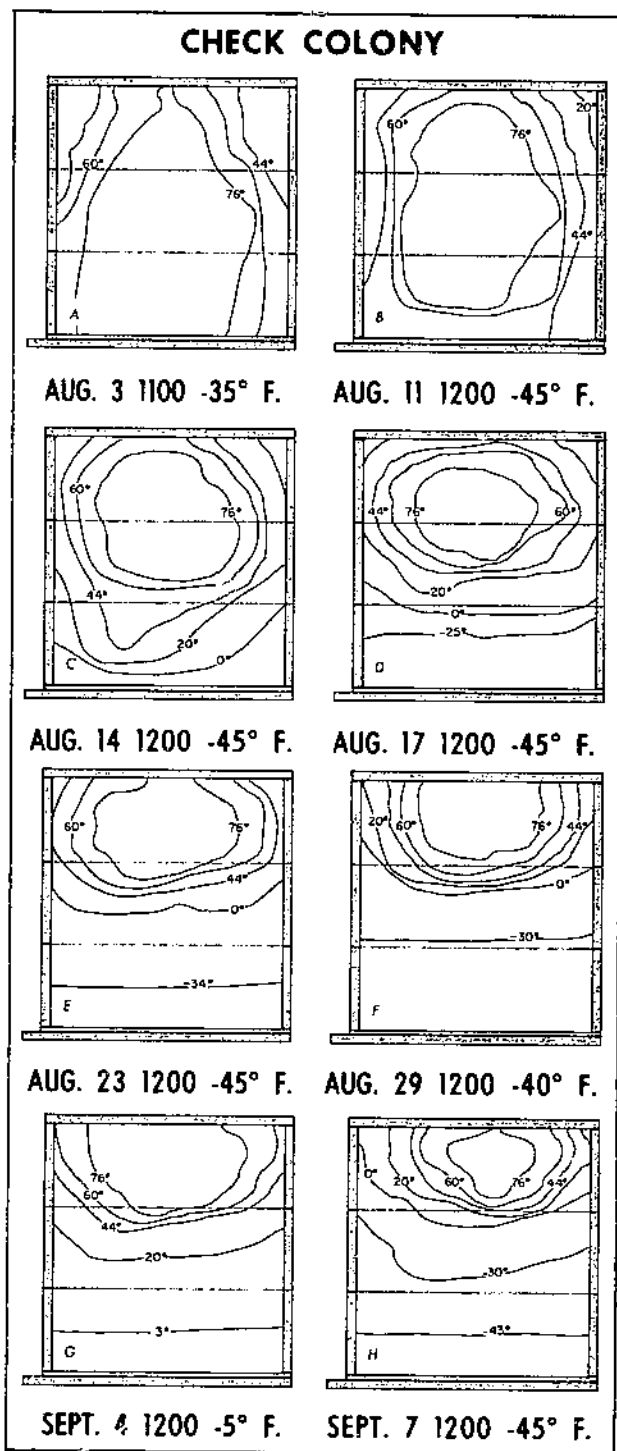

FIGURE 17.—Check colony placed in a refrigerator on July 30 and held at -45° F., showing how cluster changed in size. (Views parallel to combs.)

they been preparing for winter by forming a winter cluster prior to being placed in the chamber. The long period required to form a cluster was because the colonies tried to maintain brood rearing. A wintering cluster would not have had so much brood. The 18 days the colonies needed to form the cluster required considerably more energy to heat almost the

entire hive than would have been required by a colony already clustered.

Winter Test I

Two new three-story colonies were placed in the refrigerator on November 23. The cluster location for each prior to the test is shown in figure 18, A and E. A 1-inch layer of balsam

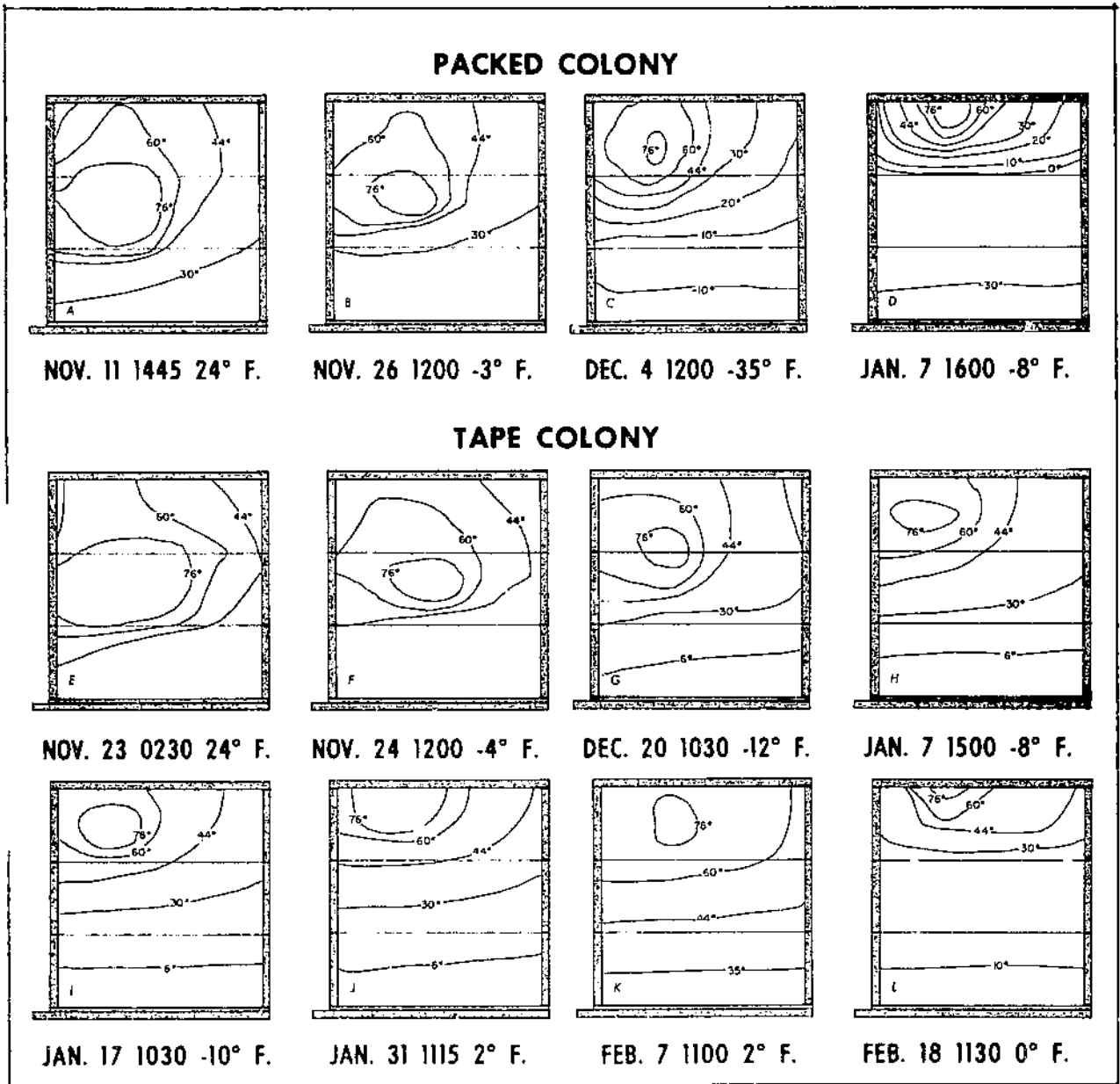

FIGURE 18.—Packed and tape colonies held in refrigerator at different temperatures for 74 and 106 days, respectively, showing how cluster changed in size. (Views parallel to combs.)

wool plus a 2-inch layer of glass wool were wrapped around each hive for insulation. One colony also had a tape heater set at 35° F. that operated for 11 weeks. The temperature was maintained with a time clock with a 20° differential, providing 15° during the day and -5° at night. The bees in both colonies formed clusters about 4 days after they were placed in the cabinet. Fifteen days after installation the clusters were entirely in the top super.

When the refrigerator was held at a constant -40° F. for 48 hours, the lowest temperature in the bottom super was -11° for the packed colony and 24° for the tape colony. The insulation did not prevent low temperatures in the packed hive but it slowed the cooling rate. The 140-watt heater did not have sufficient capacity to maintain the temperature setting in the lower body but held it in the upper bodies. Each colony was removed when the temperature reading indicated it to be in a weakened condition. After the packed colony was in the refrigerator for 74 days at a mean temperature of -3.3°, the cluster was very small (fig. 18).

The size of the tape colony cluster decreased rapidly after heating was discontinued on February 7 (fig. 18, *K* and *L*). The colony was removed after it had been in the refrigerator for 106 days at a mean temperature of

-2.4° F. Both of these colonies were heavily infected with nosema when they were taken from the cabinet.

The following winter a check colony was held in the refrigerator for 84 days (Nov. 9 to Feb. 1), during which time the cabinet temperature averaged -11.5° F. The cabinet was operated most of the time on a day-night differential of 18°. The daily maximum temperature varied from 20° to -20° and the daily minimum from -2° to -45°. The temperature was lowered each week for 7 weeks until a minimum temperature of -50° was reached. This was held constant for 48 hours. Following this the refrigerator temperature was raised a few degrees each week. The mean temperature in the hive and the volume of the cluster varied directly with the refrigerator temperature before the constant -50° period was reached. After that time the cluster fluctuations were much smaller. The maximum temperature in the cluster ranged from 79° to 88° during the test, but neither temperature occurred during the -50° period.

Figure 19 shows the temperature isotherms in the check colony when the refrigerator thermostat was set at a constant -50° F. Prior to this set of readings the refrigerator was operating at -40° at night and -20° during

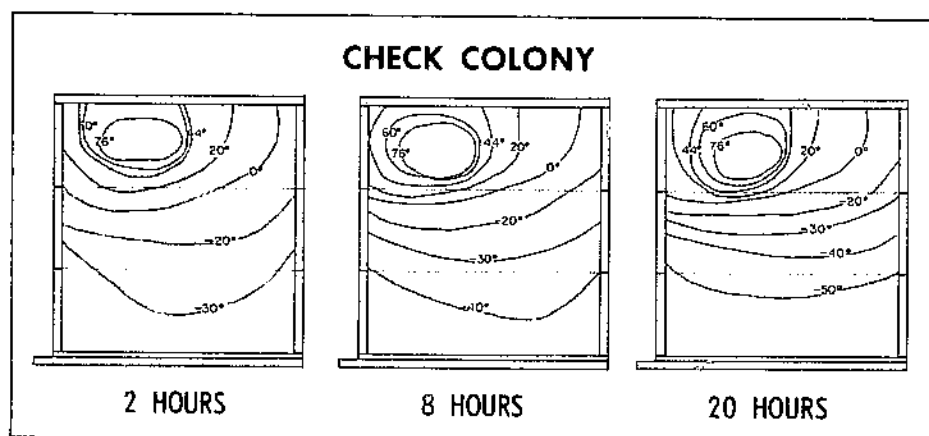

FIGURE 19.—Check colony held at -50° F., showing how hive cooled. Time is in hours after constant temperature was set. (Views parallel to combs.)

the day. Two hours after the refrigerator temperature was reduced to -50° , the lowest temperature in the hive was 40° ; 6 hours later it was -51° , and 20 hours after the setting it was -55° . Probably the air temperature was lower than indicated by the refrigerator thermostat. The maximum temperatures in the cluster were 85° , 83° , and 85° , respectively. Twenty hours after setting the thermostat, the hive temperature was 0° 1 inch below the cluster edge, which was 44° , and 6 inches to the rear of the cluster edge it was 0° . These studies showed that only 13 inches from the 85° in the center of the cluster the temperature was 140° lower or -55° . Heat from the cluster was not lost to the surrounding air, and little air circulated in the hive. Air circulation would have prevented the well-established isotherms that were recorded.

The bees maintained the center of the cluster at a temperature above 80° F., but they did not heat the hive. In fact, a large range of temperatures may exist within the hive when outside temperatures are very low and remain so for extended periods. Temperatures in some parts of the hive will approach those outside the hive.

Winter Test 2

Another colony, insulated with 2 inches of glass wool and equipped with a heater, was placed in the refrigerator on January 19 after 2 months' winter inactivity outside. It was kept in the refrigerator for 18 weeks until May 24 at a mean refrigerator temperature of -14.5° F. The highest refrigerator temperature for this test was 31° and the lowest -26° . The hive heating unit was set at 35° and operated five times during the 18 weeks for periods of 48 hours each time to determine the effect of heat on cluster volume and to let the bees move honey if necessary.

The heating of the hive changed the cluster volume. There was no indication during the heating period that the cluster shifted position or that the bees moved honey from outside the cluster area. The eventual death of the

colony was caused by starvation and failure to replace old bees. The mean hive temperature and cluster volume varied with the refrigerator temperature but were not proportional to it. Figure 20 shows these changes for the test period and also when the heater was operated. The cluster volume varied more with the daily mean temperature than with the change between night and day temperatures.

The heater raised the temperature around the hive to 40° F. and caused considerable temperature and volume change in the cluster (fig. 21). This additional heat caused brood-rearing temperatures within the cluster. Sometimes several readings were greater than 92° within the cluster. Extreme changes of outside temperature caused the 44° , 60° , and 76° isotherm volumes to change but not in direct ratio to each other. The 44° isotherm changed the most. The maximum temperature in the cluster had no relationship to the ambient temperature except when heat was suddenly added.

Winter Test 3

Another test was performed in which the refrigerator setting was varied to conform with the mean temperature recorded in International Falls, Minn., which on the average has about the coldest winters in the United States. Not only were the temperatures changed frequently to simulate normal daily changes but the length of the day temperature was adjusted to simulate winter day lengths at International Falls.

Two colonies, equal in strength, were placed in the chambers on November 18. One had no protection and the other had 2 inches of glass wool insulation. The check colony lived for 18 weeks at a mean chamber temperature of 6° F. During this time the lowest temperature was -25° and the highest 33° . The latter occurred during the first 10 days the colonies were in the cabinet. The packed colony lived 26 weeks at a mean temperature of 7.7° . Toward the end of the test the lack of honey and pollen was more detrimental to the cluster than the low temperature.

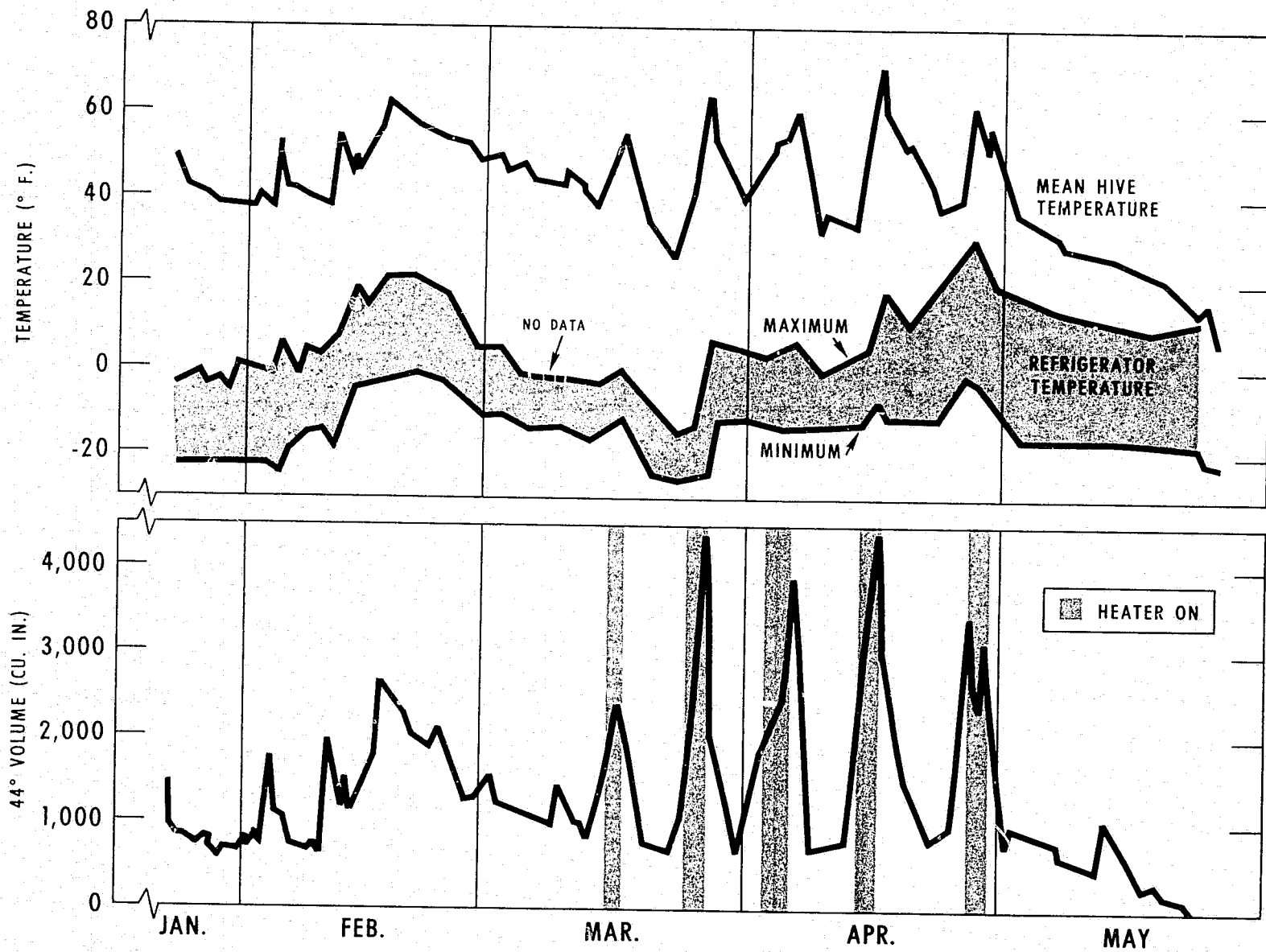

FIGURE 20.—Packed colony held in refrigerator, showing hive and refrigerator temperatures, cluster volume, and when heater was operated.

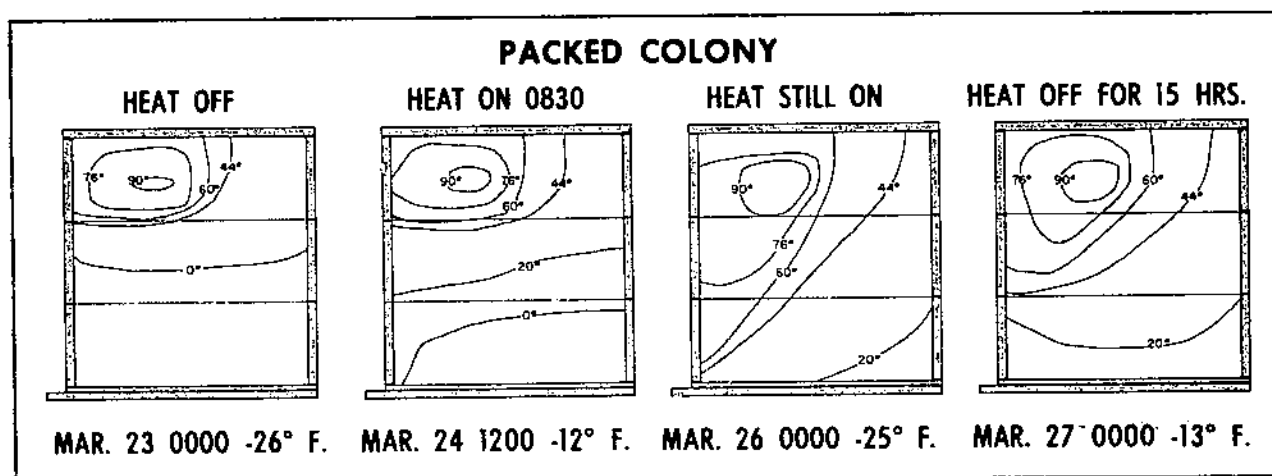

FIGURE 21.—Effect of heater on temperature and volume change in cluster of packed colony. (Views parallel to combs.)

When the chamber temperature was near 0° F., the volume of the cluster in the check colony was only 30 percent of that in the packed colony. The mean of all temperatures in the check colony was 25 to 45 percent lower than in the packed colony. This difference in temperatures depended on the cluster size, the insulation, and the refrigerator temperature. The mean temperature variations within the colony from day to night were affected by the length of time the colony had been in the refrigerator. Examples of colony temperatures at various ambient temperatures on two dates are as follows:

	Dec. 4		Jan. 16	
	Day	Night	Day	Night
Chamber air.....	8	-17	6	-14
Check colony.....	43.7	46.3	32.4	26.2
Packed colony.....	58.4	58.8	55.1	53.3

The mean temperatures tended to be lower in January because of the natural reduction in cluster population. The temperature data were analyzed for significance in change from night to day. The change in the check colony was not significant, but the change in the packed colony was significant. This means that the cluster volume in the packed colony changed with refrigerator temperature, whereas the check

colony's volume change was not directly related to the refrigerator temperature. Changes in cluster volume of the check colony occurred with the change in the mean daily refrigerator temperature more than with the difference between night and day temperatures. Possibly the insulation gave enough protection to the packed colony to permit it to adjust itself readily to outside changes, but a check colony could not do so. With a daily mean temperature change of 17.5° F., the cluster volume of the check and packed colonies changed 70 and 41 percent, respectively.

The volumes enclosed by isotherms at various temperatures for these two colonies were computed and compared. In the check hive the insulating shell (44° to 60° F.) was larger than in the packed hive. The center part of the cluster (76° and over) was also larger in proportion to the entire cluster. The cluster in the check hive had a denser insulating shell and a larger volume within the high temperature isotherm to maintain its desired temperature.

The maximum temperature in the cluster was not related to refrigerator temperature. Data from both colonies showed that there is a natural fluctuation in cluster size. This could indicate a reorganization of the cluster,

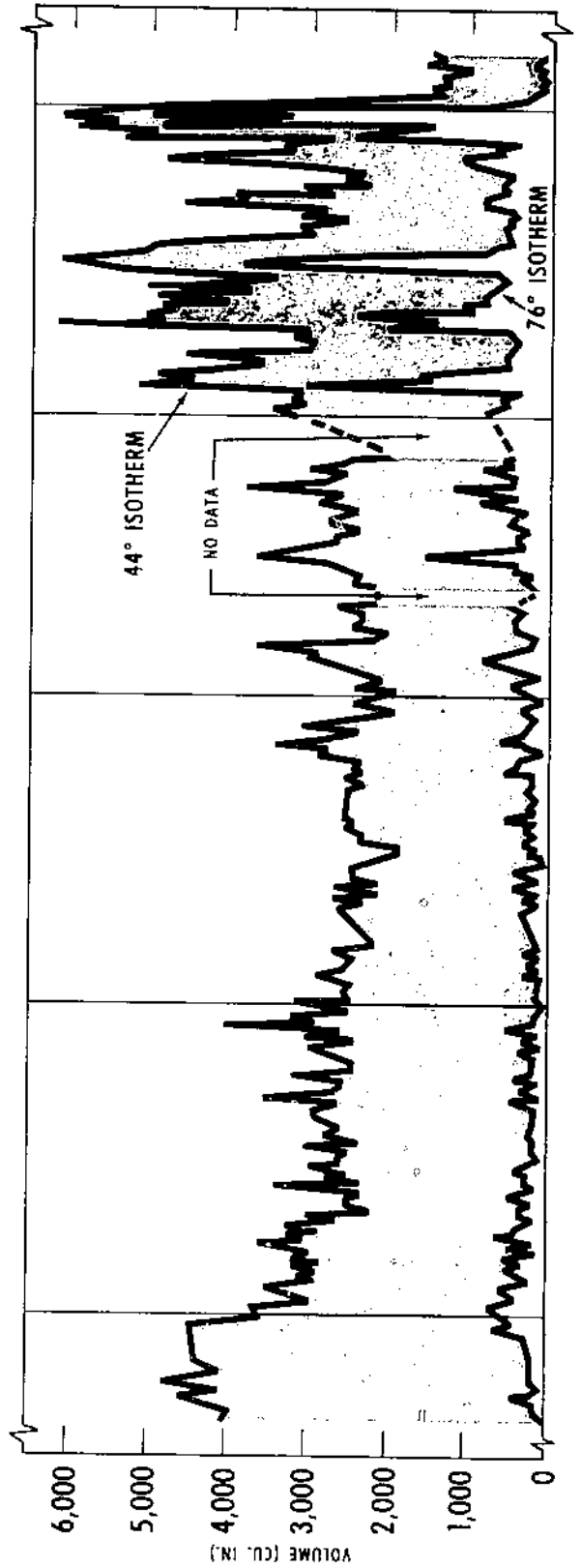
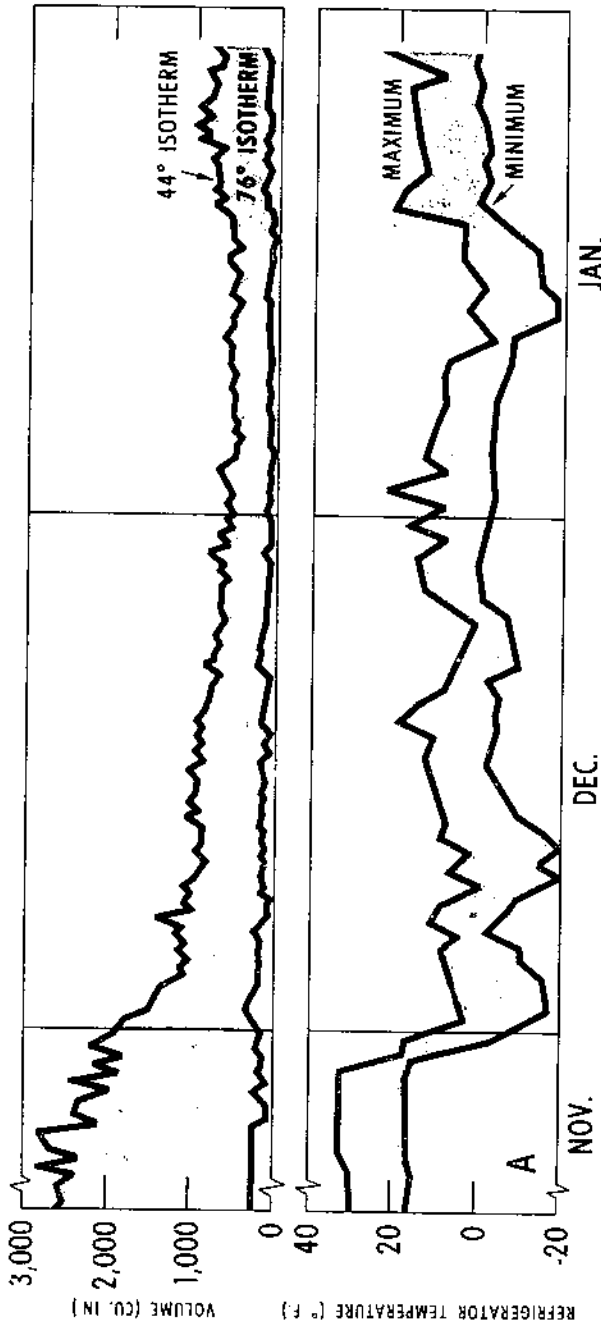

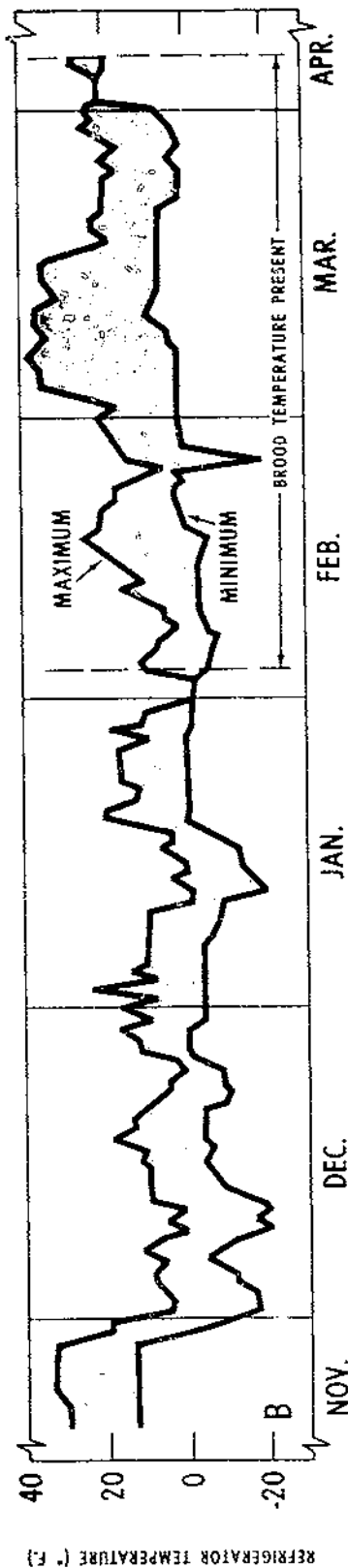

FIGURE 22.—Change in 44° and 76° F. isotherm volumes of check (A) and packed (B) colonies in refrigerator and maximum and minimum refrigerator temperatures.

which, if true, could be affected by both time and temperature. In these two colonies with different treatments the large change in cluster volume always occurred on the same dates. The cluster volume change in the 44° and 76° F. isotherms of the check colony and the refrigerator temperatures are shown in figure 22, A. The graph extends only to February because after that date there was little change in cluster volume. The data on the packed colony are shown through April 10 (fig. 22, B). After that date this colony seemed to be affected by a shortage of food. When brood was started is also indicated on this graph.

Distribution of isotherms and cluster changes are shown in figure 23. The temperature change below the cluster was greater in the check than in the packed colony. The check colony did not develop brood-rearing temperatures during the test. The packed colony developed brood-rearing temperatures after February 3. After March 1 its cluster size fluctuated widely. The uniformity among the isotherm peaks during this period indicates that the change may have been due to brood rearing, as the volumes increased rapidly and declined more gradually. Although this colony never was in an ambient temperature above 38° F., it produced brood in large amounts as long as there was a pollen supply within the hive.

The evidence is strong that colonies can withstand cold and even subzero temperatures for weeks. However, bees can maintain cluster temperatures easier if the colony is insulated. Brood can be reared under low external temperatures provided sufficient pollen and honey are available to the cluster. Fluctuation in the cluster is due in part to temperature change, which may be in the daily mean or in the differential of day to night.

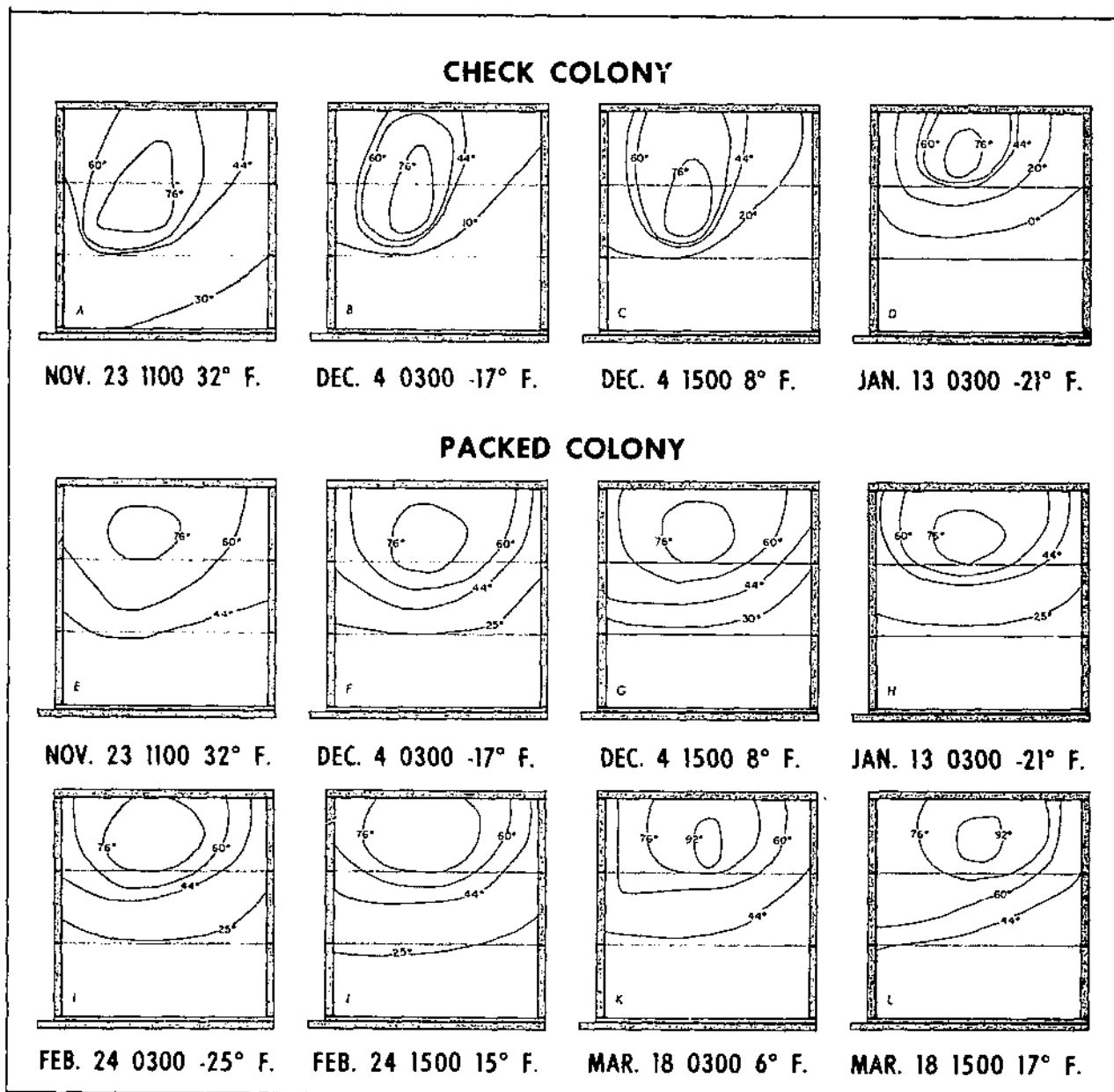

FIGURE 23.—Distribution of isotherms and cluster changes along comb of check and packed colonies in refrigerator at various dates. (Views parallel to combs.)

SUMMARY

Thermocouples were established in different planes in a hive of wintering honey bees (*Apis mellifera* L.) at Madison, Wis., and temperatures were determined. Then the colony was killed with gas. Exact determination of the cluster location in relation to recorded temperatures proved that such temperature records precisely locate the cluster and show where brood is being reared, where bee activity occurs beyond the brood area, and the insulating shell of relatively inactive bees.

From 1,200,000 thermocouple temperature determinations made in beehives during the winter, the following information was obtained:

(1) Temperature readings permit determination of the cluster size, shape, movement, and brood-rearing activities.

(2) The 44° F. isotherm establishes the outermost limit of the winter cluster.

(3) The bee population is densest at the 55° to 56° isotherm.

(4) The temperature between two frames of brood is normally 92° to 97°.

(5) When brood is on only one side of the thermocouple, the temperature ranges from 85° to 92°, depending on the stage of the brood.

(6) The unprotected (check) colonies had the tightest insulating shell, or the least distance between the 44° and 60° isotherms.

(7) A colony protected by insulation will have a less compact cluster that will fluctuate more in size with temperature change than a cluster in an unprotected colony.

(8) The area of the cluster within the 76° isotherm is the active or heat-generating area, with a relatively low density of bees.

(9) Some cluster temperature changes are associated with cluster movement for food or just changes in location.

(10) In hives heated up to 40° the cluster response is not different from that in insulated hives.

(11) Insulated colonies start brood rearing a few days earlier than unprotected colonies, but

the latter tend to catch up shortly after warmer weather arrives.

(12) As high as 100° was recorded in some seemingly normal clusters when the outside temperature was relatively uniform and moderate.

(13) The highest temperature recorded in any cluster was 105°, which occurred in a small unprotected (check) colony when the outside temperature was 8°. Its generally high cluster temperature continued for some unknown reason throughout the season.

(14) The average cluster shape is usually ellipsoidal; however, temporary unusual shapes were frequently recorded.

(15) Five colonies survived extremely low mean temperatures in a refrigerator, as follows:

Days	° F.
35	-26.8
41	-28.8
74	-3.3
84	-11.5
106	-2.4

' 2 days at -50°

(16) The temperature within the cluster varies, but under normal conditions it is not closely correlated with outside temperatures. However, a pronounced change in the temperature during the day will cause an appreciable change in the cluster size and temperature.

(17) Honey bees make no attempt to maintain the temperature in the domicile outside the winter cluster.

(18) A cluster held for long periods under freezing conditions declines in strength. The rate of decline is dependent on pollen stores available, but it is slower in insulated than in unprotected colonies.

(19) Brood rearing will occur under subzero conditions in insulated colonies with plenty of pollen and honey stores in the cluster.

(20) Under normal winter conditions either insulated or noninsulated colonies should survive at Madison, Wis.

LITERATURE CITED

- (1) BÜDEL, A.
1948. DIE FEUCHTIGKEIT IN BIENENSTOCK. Deut. Bienen Ztg. 3 (11): 163-165.
- (2) ———
1949. DIE BIENENPHYSIK IN DIENST DER PRAKTISCHEN IMKEREI. Imkerfreund 4 (9): 171-173.
- (3) ——— and HERALD, E.
1960. BIENE UND BIENZUCHT. 379 pp. Ehrenwirth Verlag, Munich.
- (4) CORKINS, C. L.
1932. THE TEMPERATURE RELATIONSHIP OF THE HONEYBEE CLUSTER UNDER CONTROLLED EXTERNAL TEMPERATURE CONDITIONS. Jour. Econ. Ent. 25: 820-825.
- (5) LAVIE, P.
1955. L'ENREGISTREMENT THERMIQUE CONTINU DANS LES POPULATIONS D' APIS MELLIFICA AVEC COUVAIN. Insectes Sociaux 2: 127-134.
- (6) OWENS, C. D., and FARRAR, C. L.
1967. ELECTRIC HEATING OF HONEY BEE HIVES. U.S. Dept. Agr. Tech. Bul. 1377, 24 pp.
- (7) SIMPSON, J.
1950. HUMIDITY IN THE WINTERING CLUSTER OF A COLONY OF HONEYBEES. Bee World 31: 41-44.
- (8) VANSSELL, G. H.
1930. BEE HIVE TEMPERATURES. Jour. Econ. Ent. 23: 418-421.
- (9) WILSON, H. F., and MILUM, V. G.
1927. WINTERING PROTECTION FOR THE HONEY BEE COLONY. Wis. Agr. Expt. Sta. Res. Bul. 75, 47 pp.

END