



AgEcon SEARCH
RESEARCH IN AGRICULTURAL & APPLIED ECONOMICS

The World's Largest Open Access Agricultural & Applied Economics Digital Library

This document is discoverable and free to researchers across the globe due to the work of AgEcon Search.

Help ensure our sustainability.

Give to AgEcon Search

AgEcon Search

<http://ageconsearch.umn.edu>

aesearch@umn.edu

*Papers downloaded from **AgEcon Search** may be used for non-commercial purposes and personal study only. No other use, including posting to another Internet site, is permitted without permission from the copyright owner (not AgEcon Search), or as allowed under the provisions of Fair Use, U.S. Copyright Act, Title 17 U.S.C.*

Agrochemical Pollution of Water Resources

**Proceedings of a Conference held on 16–18 February 2000
at Hat Yai, Thailand**

Editors: Ramsis B. Salama and Rai S. Kookana

Australian Centre for International Agricultural Research
Canberra 2001

The Australian Centre for International Agricultural Research (ACIAR) was established in June 1982 by an Act of the Australian Parliament. Its mandate is to help identify agricultural problems in developing countries and to commission collaborative research between Australian and developing country researchers in fields where Australia has a special research competence.

Where trade names are used, this constitutes neither endorsement of nor discrimination against any product by the Centre.

ACIAR PROCEEDINGS

This series of publications includes the full proceedings of research workshops or symposia organised or supported by ACIAR. Publications in the series are distributed internationally to selected individuals and scientific institutions.

© Australian Centre for International Agricultural Research, GPO Box 1571, Canberra, ACT 2601.

Salama, R.B. and Kookana, R. ed., *Agrochemical Pollution of Water Resources*. Proceedings of a Conference held on 16–18 February 2000 at Hat Yai, Thailand. Canberra, ACIAR Proceedings No. 104.

ISBN 1 86320 297 8 (print)
ISBN 1 86320 298 6 (electronic)

Managing editor: Michael Welbourn, BEST Writing and Editing Services, Adelaide, Australia

Pre-press production: Nanette Mercer, Damson Digital Design, Adelaide, Australia
Printed by:



Contents

Preface	vii
Summary of Findings	ix
Malaysia	
Site descriptions and project field activities in the Cameron Highlands <i>W.Y. Wan Abdullah, B.Y. Aminuddin, R.B. Salama, U.B. Cheah, J. Jamaluddin and G. Osman</i>	3
Monitoring of runoff and sediment load in several agroecosystems in the Cameron Highlands <i>W.Y. Wan Abdullah, J. Jamaluddin and G. Osman</i>	10
Soil erosion processes and nutrient loss in highland agricultural areas <i>G.M. Hashim and W.Y. Wan Abdullah</i>	17
Impacts of agricultural activities on soil erosion and water resources in the Cameron Highlands <i>W.Y. Wan Abdullah, R.B. Salama and B.Y. Aminuddin</i>	26
Monitoring of inorganic constituents in surface water and groundwater in selected agroecosystems in the Cameron Highlands <i>B.Y. Aminuddin, W.Y. Wan Abdullah, M. Zulkefli, A. Abd. Rahim and G. Osman</i>	32
Fate of endosulfan and methamidophos in Cameron Highlands agroecosystems <i>A.O.S. Enoma, C.U. Boh, K.Y. Lum, S. Ismail, Z. Malik and W. Y. Wan Abdullah</i>	46
Adsorption, desorption and mobility characteristics of endosulfan and methamidophos in sandy-loam and clay <i>A.O.S. Enoma, C.U. Boh, K.Y. Lum, S. Ismail and Z. Malik</i>	52
Degradation of endosulfan and methamidophos in Malaysian agricultural soils <i>A.O.S. Enoma, C.U. Boh, K.Y. Lum, S. Ismail and Z. Malik</i>	60
Thailand	
Soils, landforms and landuse in the agroecosystems of Rataphum Watershed Area, and the risk of chemical pollution <i>N. Panapitukul and W. Chatupote</i>	71
General management practices in the agroecosystems of Rataphum Watershed Area <i>A. Kamnalrut, S. Choto and S. Pipithsangchan</i>	80
On-farm comparisons between bio-insecticides and synthetic insecticides in vegetable production <i>S. Pipithsangchan, S. Sritungnan and S. Choto</i>	87
Bacterial survey in groundwater in Rataphum Watershed Area <i>N. Pengnoo and S. Choto</i>	90
Modelling pesticide and nutrient leaching in the agroecosystems of Rataphum Watershed Area <i>W. Chatupote and N. Panapitukul</i>	96

Australia

Geomorphology, soils and landuse in the Swan Coastal Plain in relation to contaminant leaching <i>R.B. Salama, D.W. Pollock, J.D. Byrne and G.W. Bartle</i>	105
Sorption of selected pesticides and their metabolites in soil profiles of the Swan Coastal Plain <i>R. Kookana, A. Kerekes, D. Oliver, R.B. Salama and J.D. Byrne</i>	118
Nutrient and pesticide leaching in experimental sites in the Swan Coastal Plain <i>R.B. Salama, J.D. Byrne and D.W. Pollock</i>	125
Modelling pesticide and nutrient transport in the Gnangara Mound <i>R.B. Salama, D.W. Pollock and J.D. Byrne</i>	138
Regional vulnerability to nutrient leaching in the Gnangara Mound under different management scenarios <i>R.B. Salama, D.W. Pollock and J.D. Byrne</i>	145
Regional vulnerability to pesticide contamination in the Gnangara Mound under different management scenarios <i>R.B. Salama, D.W. Pollock and J.D. Byrne</i>	153

Preface

THE GREAT BENEFITS of fertilisers and pesticides do not come without cost. One such cost is water pollution. Hence the implicit research question underlying each paper in these Proceedings was: how can sustainable intensive agriculture be at its most productive, without polluting water resources? The main focus was on the need for uncontaminated water to be freely available for drinking.

This volume records the main research findings of ACIAR Project LWR1/1994/054 as presented to a conference held in Thailand on 16–18 February 2000. The aim of the project was to identify and evaluate promising technologies and management options to minimise the contamination of water resources by agrochemicals. It focused on agricultural systems that depend on chemical inputs such as fertilisers and pesticides (herbicides, insecticides, and fungicides).

The purpose of the project was to better understand the principles by which agrochemicals contaminate surface water and groundwater under these conditions. The research program was developed to evaluate and use predictive modelling using system parameters, and to devise and evaluate management practices to minimise pollution. The research was conducted by three organisations: the Malaysian Agricultural Research and Development Institute (MARDI); the Faculty of Natural Resources, Prince of Songkla University, Thailand (PSU); and the Commonwealth Scientific and Industrial Research Organisation, Land and Water Division, Australia (CSIRO). The project was conducted at three contrasting sites in Malaysia, Thailand, and Australia.

In Malaysia, surface water monitoring involved small plots, small sub-catchments, catchments, and major rivers in the Cameron Highlands. Flow was measured in all sites in order to estimate pesticide loads. MARDI conducted specialised experiments evaluating transport of pollutants in surface and groundwater, field and laboratory characterisation of system parameters, long-term monitoring of experimental sites, and application and evaluation of modelling techniques.

In Thailand, groundwater monitoring was conducted in three different geomorphological areas within Rataphum Watershed: uplands (fruit orchards); slopes (rubber); and flats (vegetables). PSU investigated groundwater pollution problems through field surveys, experimentation and common technology. It evaluated the application of models and the impact of modifying management practices.

In Western Australia, CSIRO conducted detailed field experiments to investigate groundwater pollution problems in the Gnangara Mound aquifer below the Swan Coastal Plain. Monitoring of water quality with respect to selected pesticides was conducted at three different levels: small-scale (column and undisturbed cores) in the laboratory; medium-scale field experiments; and large-scale monitoring in agricultural areas.

The Australian team also coordinated the various techniques, analytical methods and modelling used in various CSIRO pesticide projects, and transferred the technology to its counterparts in Malaysia and Thailand.

Thanks are due to MARDI, PSU and CSIRO for their generous support of the project activities in their respective countries and to the landholders who provided land or access for the field work. Thanks are also due to all the scientists and support staff for their contributions to both the project and the conference.

R. B. Salama
R. Kookana

Summary of Findings

I R Willett

ACIAR Research Program Manager, Land and Water Resources

THE PROJECT'S APPROACH was to make an initial assessment of the extent and spread of contamination of surface and ground waters in the Cameron Highlands and the Rataphum watershed. This included, in each of the main cropping systems, assessment of farmers' practices that may lead to contamination of groundwater and runoff water, or to excessive losses of eroded soil.

The initial assessment was complemented by detailed plot work and the application of leaching and pesticide degradation models. Some laboratory work was required to obtain information on the sorption and degradation behaviour of pesticides used in the areas. Some of these data were applied to models to describe the leaching of nitrate and the leaching and degradation of pesticides in intensive tropical agriculture. More emphasis was given to surface runoff and soil erosion in the steep areas of the Cameron Highlands.

Recommendations for reducing nutrient and pesticide contamination of water resources were developed. Also, for those sites where the major concern is groundwater contamination, the project devised a means of assessing groundwater contamination by nitrate and pesticides on a regional scale.

Malaysia

Erosion of surface soil in the Cameron Highlands is of serious concern. Soil loss can be expected to be very large during construction of terraces and flattening of hilltops. After establishment of intensive vegetable farms, soil losses remain high – in the region of 83 t/ha/yr. Erosion rates are generally high during crop establishment, and decrease during the growing season as surface coverage increases. In furrow and bed systems used for vegetables, initial erosion is due to raindrop detachment of soil from the beds. Some of the detached soil accumulates into the compacted furrows. Rapid soil loss occurs in overland flow down the furrows during heavy rainstorms. Erosion rates of soil used for flower production under plastic shelters are very much less (about one t/ha/yr) because the soil is not subjected to natural rainfall. Erosion from tea plantations occurs in empty rows and landslip-scarred areas and is generally low.

Analyses of suspended sediment and the original soil showed that transported materials were enriched in nutrients. The finest particles were the most enriched; they were also likely to be transported furthest, and to ultimately reach reservoirs and other surface-water bodies.

Under cabbage about three per cent of applied nitrogen was lost in runoff. The loss was most rapid soon after application of the fertilisers and decreased during the growing season. The findings suggest that erosion-mitigation measures are required in vegetable-growing areas. Shelters used in high-value flower production effectively control erosion, but their high cost restricts their use to this specialised industry. Losses of nitrogen by leaching in cabbage farms were about eight per cent of the nitrogen applied. Losses of nutrients from the soil were small in comparison with the amounts applied in organic and inorganic fertilisers. Such losses were insignificant in terms of crop production; however, they may be a significant source of nitrogen in surface-water bodies.

Endosulfan and methamidophos insecticides, and their degradation products, were detected in trace quantities in surface runoff water and in water that drained into lysimeters. Residues were also detected in the soil. Methamidophos, although more mobile than endosulfan in Cameron Highland soils, was degraded rapidly by microbial activity (half-life of 5–8 days), whereas endosulfan was more persistent (half-life of 433–495 days). Therefore endosulfan has greater potential as a contaminant than methamidophos.

Thailand

In the Rataphum watershed of southern Thailand, a general assessment of risks of agrochemical contamination identified intensive vegetable production on alluvial soils with shallow watertables as most at risk. During the course of the study, misuse of pesticides and poor practices, such as over-application of homemade mixtures, were observed. Contamination risks from rubber plantations were rated as 'low' and restricted to the relatively small areas (5–10 per cent) being re-established at any one time. Tree fruit production is still a smallholder activity and not subject to large inputs of fertiliser or pesticide.

Modelling studies for a wide range of pesticides showed that there was little potential for leaching or for contamination of groundwater. However, all such studies assume homogenous porous media where water and solute flow are uniform; also the input data on pesticide properties are from other countries and known to not relate well to local soils. Therefore conclusions reached from modelling studies must be regarded as, at best, preliminary. The studies also showed that maintaining organic matter concentrations of the surface soil and reducing irrigation water applications would be effective in reducing the leaching potential of pesticides. Potential for nitrate leaching was greater than that of pesticides.

On-farm evaluations of bio-insecticides, entomopathogenic bacteria (*Bacillus thuringiensis*), and nematodes (*Stienernema carpocapsae*) showed that they were not as effective as synthetic insecticides in controlling insect pests on chaisim vegetables. The higher costs and lower yields of plots treated with the bio-insecticides and reduced inputs of synthetic insecticides make this means of pest control unattractive to farmers.

The shallow groundwater is utilised for drinking water supplies and a survey was made of coliform bacteria in wells in the rubber, fruit tree and vegetable-growing areas. Excessive numbers of coliform bacteria, in terms of drinking-water standards, were found in all areas and were greatest in shallow wells in vegetable-growing areas. Protection from contamination and boiling of water intended for human consumption are recommended.

Australia

In Western Australia, a detailed study of the soils of part of the Swan Coastal Plain was made to assess their susceptibility to leaching of pesticides and nutrients.

The soils were described in terms of their sand and organic carbon contents, soil water retention, hydraulic conductivity and bulk density. Detailed soil maps were compared to GIS-produced hydrogeomorphic maps. It was found that the hydrogeomorphic maps could be used to classify catchments in terms of their susceptibility to leaching in the absence of detailed soil maps. The sorption properties of the soils for a range of pesticides and metabolites were determined in the laboratory. There was a general trend for increasing sorption with increasing organic carbon concentration. The metabolites of atrazine and fenamiphos had much lower affinities for soil than their parent compounds, and may therefore be vulnerable to leaching to the groundwater. The sorption capacity of subsoils low in organic carbon was very low; so once a pesticide or metabolite leached below the surface soils, it moved easily. However even in field experiments where pesticide residues were detected at trace levels in the soils, they were not detected in groundwater samples taken by a range of techniques.

Modelling studies of various irrigation vs. organic carbon scenarios in surface soils indicated that the risk of pesticides leaching below one metre is low, although the potential for leaching varied between soil-types. Given the high permeability of soils in the Swan Coastal Plain, careful choice of pesticide, keeping pesticide application frequency low, and improving irrigation practices are recommended to prevent leaching. Nitrogen, as ammonium as well as nitrate, leached rapidly through these soils when used for intensive horticulture (strawberry and turf production). Reducing irrigation water applications to that required for crop growth can reduce the leaching. Regional maps of the vulnerability of groundwater to nitrate accessions were also produced. Nitrate leaching was predicted in the range 16–400 kg N/ha. The amount leached increased with the rate of fertiliser application and the quantity of irrigation water. As with pesticides, optimising fertiliser and irrigation inputs reduces the transfer of nitrate to the groundwater.

Conclusions

The first requirement in any effort to reduce pollution in agricultural systems is to identify the practices and land, soil and water systems that are the most likely sources. At each study site of the project, the agricultural systems responsible for contamination of water resources were identified.

In the Cameron Highlands, loss of nitrogen to surface runoff and then to surface water bodies, and leaching of nitrate to groundwater, during intensive (unsheltered) vegetable production were the main sources of contaminants. Loss of soil by water erosion was also serious during the construction of terraces, but could be stabilised at an acceptable level by soil conservation practices once cropping was established. Soil conservation practices are essential for horticultural production in the Cameron Highlands. The use of rain-shelters greatly reduced losses in runoff and erosion, but these are only feasible for very high-value crops such as cut flowers.

Intensive horticultural activities were also the cause of pollution in the Rataphum watershed and the Gngangara Mound area. At these two sites, the main concern was the leaching of nitrate to the groundwater. Although none of the tested pesticides was detected in groundwater, it is likely that some residues, too low to detect experimentally, would reach the groundwater especially in the irrigated shallow-waterable areas.

At all project sites used for perennial trees (tropical fruits and rubber in Thailand, tea plantations and jungle in Malaysia, and pine plantations and disturbed bushland in Western Australia) there was very little potential for pollution because of the small rates of application of pesticides and fertilisers and the lack of irrigation.

At all sites used for intensive production it was shown that reduction in the pollution of groundwater can be achieved by limiting:

- fertiliser applications to that required for production,
- pesticide inputs to the recommended rates, and
- irrigation water applications to that required for crop growth.

In light-textured soils that receive pesticides it is also recommended that organic carbon concentrations in the surface soil be maintained or increased. The non-point nature of the pollution considered in the agricultural systems of this project can only be reduced by changes in farmers' practices. It is unlikely that legislation or regulation would be effective in achieving this, other than by deregistering persistent pesticides.

Implementation of the project's results requires educational activities to show farmers how to change their practices to reduce pollution. This may be achieved by incorporating environmental objectives with extension activities primarily aimed at improving crop production and farmers' incomes. Another approach, which has been successful in other countries, would be to link promotion of non-polluting practices with external support for improving water supplies in rural areas. It seems more likely that rural folk will adopt practices that reduce contamination of water if they understand the direct link between health and improved water supply and quality.

These results are being transferred to existing programs examining pesticide use and residues.

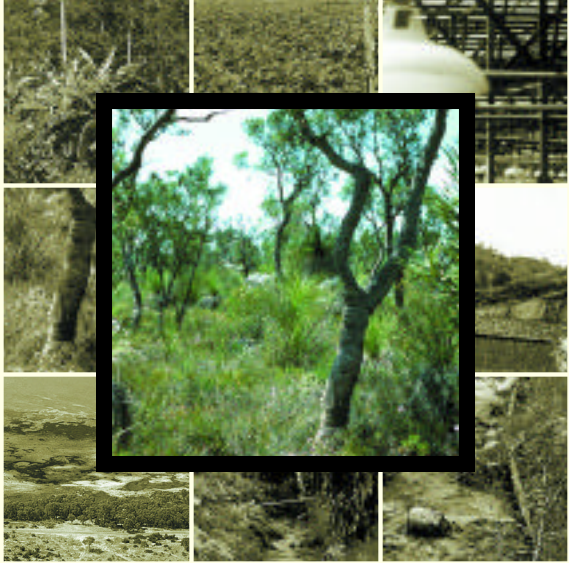

A u s t r a l i a

THE SWAN COASTAL PLAIN near Perth, Western Australia, was the location of the Australian project site. In contrast to the other sites, the climate is Mediterranean, the relief is generally low, and the soils are very sandy. The area supports remnant vegetation and some pine plantations, and is also used for intensive horticultural activities such as market gardens for vegetables, flowers and fruits, and turf farms. The Gnangara Mound aquifer, the main focus of the project, is an important source of water for the city of Perth. So, like the other two sites, protection of water resources from the effects of intensive agricultural production is a well-established priority.

Geomorphology, Soils and Landuse in the Swan Coastal Plain in relation to Contaminant Leaching

R.B. Salama, D.W. Pollock, J.D. Byrne and G.W. Bartle¹

Abstract

A detailed study of the soils of the southern part of Gnangara Mound in the Swan Coastal Plain was carried out to determine their soil-water characteristics and their leaching capacity to nutrients and pesticides. Physical, chemical and hydraulic characteristics of the topsoil (0–15 cm) and the subsoil (40–50 cm) were measured at 21 sites representing the major soils under the different landuses in the area. The results show that Bassendean Sands have higher coarse sand particles and consequently higher hydraulic conductivity than Spearwood Sands. The Bassendean Dunes generally have low relief; minor variations in topography translate into variable depths to watertable, which are the basis for division into soil mapping units. For example the Gavin soil has higher organic carbon content than all other soils sampled. The Spearwood Dunes are divided mainly on the depth of soil over the limestone substrate and the incidence of karst features. The Spearwood and Jandakot soils have lower coarse sand and lower carbon content, while the Karrakatta soils have the least amount of organic carbon. Detailed soil maps were compared with GIS-produced hydrogeomorphic maps. The results show that the distribution of HGUs in the catchment is controlled by the geological formations on which they were developed. The results also show that the hydrogeomorphic maps can be used in the absence of detailed soil maps to classify the catchment into areas that have similar soil characteristics. Filtering capacity of the soils is dependant on organic material, clays and other minerals. Based on these criteria, Spearwood Sands have the highest filtering capacity, followed by Bassendean and Quindalup.

THE GNANGARA MOUND is part of the Swan Coastal Plain which was formed mainly of depositional material either from fluvial or aeolian origin. The plain consists of a series of geomorphic entities, which are sub-parallel to the present coastline. The most easterly feature of the Mound is a series of laterite covered spurs forming the foothills of the Darling Scarp. Stretching from the foot of the hills is the relatively flat Pinjarra Plain built up of alluvium of varying ages. It is up to 13 km wide and is terminated sharply at its western edge by a series of coastal sand dunes: the Bassendean Dune System in the east, followed by the Spearwood Dune System, with the Quindalup Dune System fringing the present coastline (McArthur and Bettenay 1960).

The generalised surface geology of the study area is mainly based on the soils consisting of the Guildford clay in the east, the Bassendean and Spearwood sands in the middle, and the Tamala limestone and Safety Bay sand (Quindalup Dune System) on the beach.

The alluvial terrain includes the drainage system which discharges from the Gnangara Mound. The north and northeast drainage lines, which discharge into Gingin Brook, are mapped as Gingin Brook Complex (GG). The eastern drainage system towards Ellen Brook and the Swan River have been mapped as the Yanga unit (Ya).

Soils

The soil classification used in this study is summarised from McArthur and Bettenay (1960), and shown in Figure 1.

The Bassendean Dune System is generally of low relief with minor variations in topography; this means that the watertable is at variable depths, and this variation is the basis for division into soil mapping units. The landscape comprises 20 m high ridges and permanent open-water lakes. The flat or gently undulating terrain supporting Gavin soils (G) has less than

¹ CSIRO Land and Water, Private Bag No 5, PO Wembley, Western Australia 6913

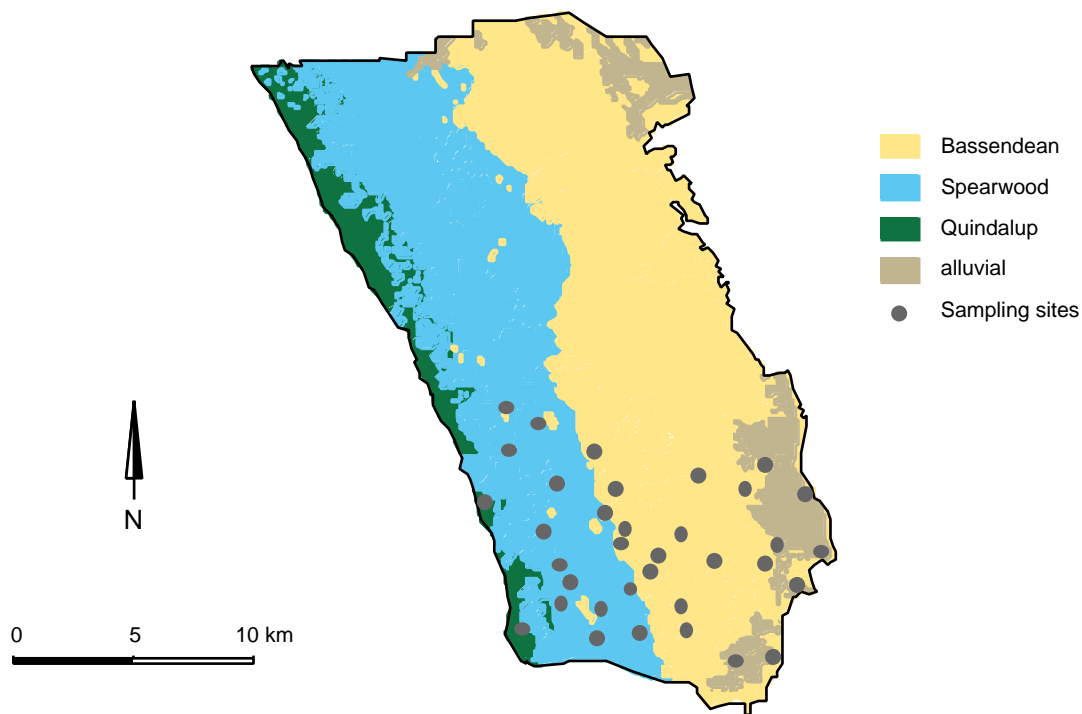

Figure 1. Gngangara Mound soils.

5 m relief. The hills and ridges (Jandakot soils (Ja) generally have more than 5 m relief, with one area of exceptionally high ridges mapped as Jandakot-Steep. The dunes probably accumulated as shoreline deposits and coastal dunes during interglacial periods of high sea-level and consist of lime sand, quartz sand and minor fine-grained, black, heavy mineral concentrations. The carbonate material has been completely leached, leaving dunes consisting entirely of quartz sand.

The Spearwood Dune System is classified mainly on the basis of depth of soil over the limestone substrate and the incidence of karst features. Limestone is exposed or covered with shallow soil (Limestone (Kls)) on the hills and ridges. In lower positions, the sand may be several metres thick and is mapped as the Karrakatta unit: the sand may be yellow almost to the surface (Karrakatta Yellow (Ky)), or grey in the surface layers (Karrakatta Grey (Kg)). In the karst depressions the slopes are mapped as Spearwood (Sp). The depressions often have permanent lakes (W) with poorly-drained areas, mapped as Beonaddy (B) around the edge.

The Quindalup Dune System occurs mainly west of the Wanneroo Road; the mapping units include

four phases (Q1–4), unstable sand (Qu), deep calcareous (Qp) and shallow calcareous (Qs).

Landuse

The three most common landuses in the Gngangara Mound are modified remnant vegetation, pine plantations, and market gardens (Figure 2 and Table 1). All three are major water users and either decrease the recharge to the aquifer (pines and reserves) or take water from the aquifer (agriculture), in addition to heavy abstraction by the Water Corporation for water supply and the thousands of wells used for domestic gardens. The minor landuses are water bodies and swamps (10 261 ha), drainage lines (2269 ha), and remnant vegetation (754 ha). This is in addition to the expanding urban areas which cover about 20 per cent of the Mound.

Modified remnant vegetation

An area of 86 000 ha is in natural reserves, in most cases slightly to moderately disturbed. This modified remnant vegetation is mainly in the Jandakot and Gavin sand ridges of the Bassendean Dune System, and the Karrakatta, Limestone and Spearwood units of the Spearwood Dune System. *Banksia* spp. predominate, and the vegetation is largely open banksia woodland or low proteaceous and myrtaceous scrub on

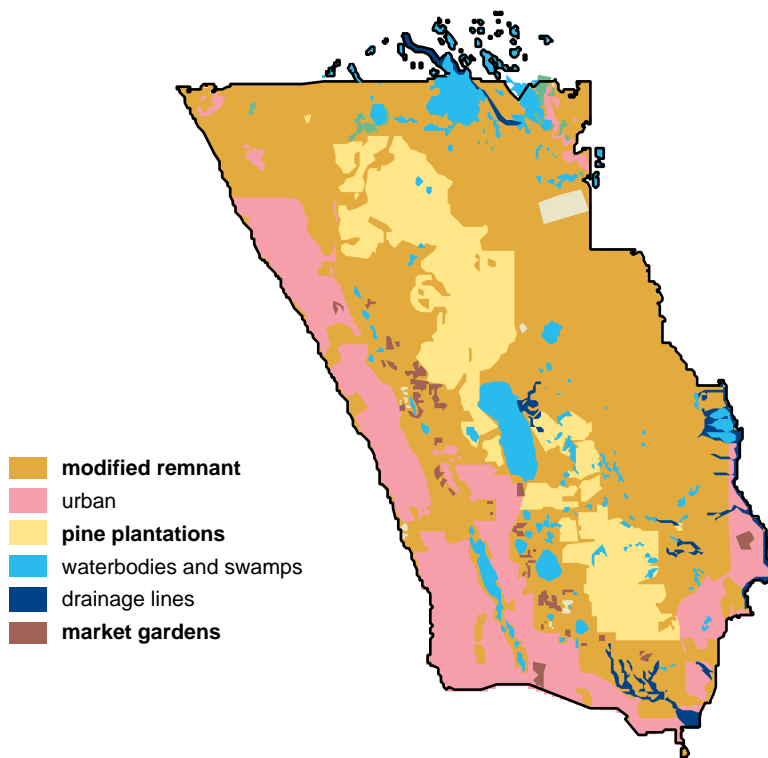

Figure 2. Gngangara Mound landuses.

limestone. It can be divided into two categories: species with deep roots; and species with shallow roots. The shallow-rooted species depend on the soil moisture in the profile, whereas the deep-rooted species may take part of their water from the capillary zone.

Pine plantations

An area of 24 000 ha has been established with pine plantations on the northern portions of the Swan Coastal Plain. The original land objectives were to produce saw-log timber for the Perth Metropolitan market.

Market gardens

The major agricultural activity in the Gngangara area is intensive horticulture (1925 ha), predominantly market gardens for vegetables, native and greenhouse flowers, citrus, avocados, stonefruit, grapevines, turf and nursery crops. It is an important market gardening area, due to its close proximity to metropolitan markets. It is a particularly significant growing area for broadleaf vegetables, and currently produces 58 per cent of the lettuce crop in Western Australia. Most production is on the sandy soils of the Bassendean and Spearwood Dune Systems.

Methodology

To study the leaching potential of the Gngangara soils to the most commonly-applied pesticides in the horticulture industry, 50 sites were selected for groundwater sampling and 21 for soil and water sampling and estimation of soil hydraulic parameters. The sites were selected to represent the three major landuses and the various management practices for the major soil-types: Gavin (G), Jandakot (Ja), Joel (J), Beonaddy (B), Karrakatta Grey (Kg), Karrakatta Limestone (Kls), Karrakatta Yellow (Ky), Spearwood (Sp).

Soil sampling

Soil samples were collected from topsoil (0–15 cm) and subsoil (40–50 cm), for the determination of physical and chemical properties of the soils. The topsoil samples were obtained with a hand trowel after removing any detritus and organic matter overburden; the subsoil samples were obtained by digging a 50 x 50 cm hole to the required depth, then using a hand trowel. The samples were placed into a strong plastic bag with most of the air removed and the bag sealed with PVC tape. The samples were well mixed

and divided into two halves, one for the determination of physical and hydraulic properties, the other for chemical and pesticide studies. Separate samples were also collected from each site for bulk density.

Table 1. Landuse in the southern Gngangara Mound.

Landuse	Area (ha)	Proportion (%)
Modified remnant	86 074	54.9
Urban	30 998	19.8
Pine Plantations	23 807	15.2
Water bodies & swamps	10 261	6.5
Drainage lines	2269	1.4
Market gardens	1925	1.2
Remnant	754	0.5
Unidentified	736	0.5
Totals	156 824	100.0

Particle-size distribution

Particle-size distribution was carried out using sieve analysis as recommended by the US Department of Agriculture (USDA). The soil was mixed thoroughly and a homogeneous sub-sample of about 200 g was placed in an air-forced drying cabinet for 12 hours at 52° C. The samples were sieved through a 2 mm sieve to remove any large organic matter, stones and gravel. The clean sample was passed through a set of five sieves for the following sizes: 1–2 mm (very coarse sand); 0.5–1.0 mm (coarse sand); 0.180–0.5 mm (medium sand); 0.063–0.180 mm (fine sand); and < 0.063 mm (silt and clay). Neither gravel nor stones were partitioned from any sample.

Soil-water retention

Soil water desorption data was obtained using the method described by Topp et al. (1993). Soil water retention for both topsoil and subsoil was determined for all soils. Soil moisture content, θ_g (gravimetric) and θ_v (volumetric), were obtained for the soils at five matric potentials: 0, -10, -30, -100, and -1500 kPa. Soils were air-dried at 52°C for 12 hours. The soil core rings had a fine nylon filter mesh material of ~90 μ m secured to the bottom of the ring. The ring was held down on a smooth surface, and then the outside of the ring was gently tapped to bring the dry soil to within approximate field-measured bulk density. The soils were then brought to saturation using de-aired tap water over three days at 21°C. The saturated soil samples were placed onto porous ceramic tension plates, covered and allowed to equilibrate at the different matric potentials applied. The matric potentials of -10 and -30 kPa were applied for seven days. The negative potential of -100 kPa was applied for ten days, whilst the negative potential of -1500 kPa was applied for 14 days.

Hydraulic conductivity

Hydraulic conductivity (Ksat) measurements were made using a ponded disc permeameter, (positive water potentials) fitted with a data logger to record the rate of drop of the water column. A stainless steel ring (4 cm deep x 20 cm diameter) was placed onto the clean-levelled soil surface and gently pressed half way into the soil. Two soil samples were taken from outside of the ring to determine initial soil moisture contents. The water-filled permeameter was placed on top of the ring and set to run. Two more soil samples were obtained from under the disc permeameter immediately after the water had left the soil surface. Logged data was used to determine K values for the soils. The hydraulic conductivity was calculated from the slope of the 'cumulative infiltration versus time' graph at early and late times as infiltration proceeded. Early infiltration was attributed to predominantly capillary behaviour (sorptivity). Gravity drainage was determined when the soil reached constant moisture content.

Bulk density

One bulk density sample was obtained from the top-soil and one from the subsoil using 50 x 47 mm stainless steel rings with chamfered outer edges to reduce friction. A spatula was used to level off the top and bottom surfaces, and the sample was gently tapped into a pre-weighed 250 ml tin can and sealed. Soil moisture contents were also obtained from these samples.

Organic carbon

A 200 g sub-sample was obtained from the bulk soil samples. These were then air-dried at 52°C for 12 hours and sieved through a 2 mm sieve. A 15 g sub-sample was removed, placed into a plastic vial and sealed. The analysis was conducted in the Western Australia Chemistry Centre using the Walkley and Black Method SO9.

Soil Characteristics

Water repellence occurs in the surface horizons of many acid coarse-textured soils. This phenomenon has been attributed to the coating of the sand particles with a skin of organic material. Dehydration of these skins during a hot dry summer cause them to become hydrophobic. This results in an uneven pattern of water infiltration at the start of the wet winter period. The continuous action of the raindrops removes the organic skin (Roberts and Carbon 1971).

The soils of the Gngangara Mound are mainly sandy soils (Table 2), with no gravel and generally <1.5 % very coarse sand (1.0–2.0 mm), 2–57 % coarse sand (0.5–1.0 mm), 20–78 % medium sand (0.18–0.5 mm),

Table 2. Particle-size analysis.

Site No.	Soil-type	Landuse	Sample Depth (cm)	Particle Size (%)				
				Very Coarse Sand (1.0–2.0 mm)	Coarse Sand (0.5–1.0 mm)	Medium Sand (0.180–0.5 mm)	Fine Sand (0.180–0.063 mm)	Silt+Clay (<0.063 mm)
1	J	Bb	0–15	0.15	18.57	72.90	7.29	1.62
			40–50	0.15	14.99	77.72	5.71	1.36
2	Ja	Bb	0–15	0.13	57.87	39.33	1.88	0.74
			40–50	0.16	49.29	48.24	1.73	0.25
3	G	Bb	0–15	0.56	47.14	46.17	4.78	0.87
			40–50	0.11	29.97	62.84	6.43	0.59
4	G	Mg	0–15	0.41	16.73	77.89	3.93	1.04
			40–50	0.23	12.08	82.02	5.05	0.68
5	B	Bb	0–15	1.27	45.05	47.15	5.31	1.13
			40–50	0.84	35.07	55.71	6.73	1.59
6	G	P	0–15	0.36	27.99	65.00	4.97	1.96
			40–50	0.12	19.74	74.39	4.26	1.36
7	Ky	Mg	0–15	0.72	59.97	35.58	2.71	1.03
			0–15	0.61	51.96	43.67	2.74	1.04
8	Sp	Mg	0–15	0.69	41.45	52.45	4.00	1.42
			40–50	0.33	37.19	59.21	2.49	0.82
9	Sp	Bb	0–15	0.76	28.92	63.82	5.02	1.34
			40–50	0.2	20.79	74.92	3.61	0.61
10	Ky	Bb	0–15	0.59	75.94	20.35	1.89	1.26
			40–50	0.47	65.70	30.79	2.01	1.16
11	Ja	Bb	0–15	0.39	30.11	65.46	3.16	0.10
			40–50	0.16	22.13	72.77	4.19	0.93
12	Sp	Mg	0–15	1.13	55.78	36.10	4.33	2.72
			40–50	0.91	45.75	44.84	6.93	1.07
13	Ky	Mg	0–15	1.50	33.68	49.01	12.23	3.78
			40–50	1.07	34.46	51.90	10.45	2.33
14	Kls	Mg	0–15	2.05	32.99	48.83	13.42	3.17
			40–50	1.52	22.94	54.54	18.62	2.61
15	J	Bb	0–15	0.52	54.50	41.39	2.72	1.02
			40–50	0.29	44.06	53.15	1.70	1.00
16	Ky	Mg	0–15	0.94	54.80	35.81	6.84	1.78
			40–50	0.86	50.79	39.78	6.94	1.80
17	G	P	0–15	0.57	44.23	51.26	2.79	1.48
			40–50	0.57	41.15	55.30	2.31	0.82
18	B	Mg	0–15	1.40	45.45	41.38	8.91	3.01
			40–50	1.48	49.12	40.85	6.51	1.96
19	Kls	Mg	0–15	1.13	46.94	45.27	5.21	1.52
			40–50	0.64	57.74	37.50	3.07	1.05
20	J	Bb	10	0.06	9.97	87.07	1.94	1.00
			200	0.15	5.07	91.53	3.04	0.49
			400	0.00	2.32	91.68	6.04	0.16
21	J	Mg	0–10	0.18	49.72	43.90	4.92	1.58
			40–50	0.26	48.96	45.02	4.17	1.43

Notes: Soil Systems & Types

Bassendean Dunes: G = Gavin, Ja = Jandakot, J = Joel

Spearwood Dunes: B = Beonaddy, Kg = Karrakatta Grey, Kls = Limestone, Ky = Karrakatta Yellow, Sp = Spearwood

Landuses

Bb = Banksia bush, P= pines, Mg = market gardens.

Table 3. Soil-water retention.

Site No.	Soil-type	Landuse	Sample Depth (cm)	Bulk Density (Dry, lab-packed) (g/cm ³)	Soil Moisture Content				Wilting point (-1500 kPa)					
					Saturated Soil (0 kPa)	Field Capacity (-10 kPa)	-30 kPa	-100 kPa	θ_g	θ_v	θ_g	θ_v		
1	J	Bb	0-15	1.25	0.41	0.52	0.40	0.50	0.26	0.33	0.10	0.13	0.06	0.08
			40-50	1.52	0.26	0.39	0.24	0.36	0.16	0.24	0.05	0.07	0.02	0.03
2	Ja	Bb	0-15	1.60	0.24	0.38	0.22	0.36	0.09	0.14	0.03	0.05	0.02	0.03
3	G	Bb	40-50	1.64	0.22	0.35	0.22	0.32	0.05	0.09	0.01	0.02	0.01	0.01
			0-15	1.57	0.33	0.45	0.34	0.46	0.16	0.21	0.07	0.09	0.05	0.07
4	G	Mg	40-50	1.59	0.23	0.37	0.22	0.36	0.10	0.16	0.03	0.04	0.01	0.02
			0-15	1.46	0.32	0.46	0.30	0.44	0.14	0.21	0.06	0.08	0.04	0.05
5	B	Bb	40-50	1.59	0.25	0.40	0.23	0.37	0.11	0.18	0.02	0.03	0.01	0.01
			0-15	1.34	0.38	0.51	0.35	0.46	0.16	0.21	0.08	0.10	0.06	0.08
6	G	P	40-50	1.61	0.23	0.37	0.20	0.33	0.07	0.12	0.02	0.03	0.01	0.02
			0-15	1.26	0.39	0.49	0.37	0.47	0.25	0.32	0.11	0.14	0.08	0.10
7	Ky	Mg	40-50	1.50	0.27	0.40	0.25	0.37	0.09	0.14	0.03	0.05	0.02	0.03
			0-15	1.54	0.25	0.39	0.22	0.34	0.06	0.10	0.03	0.05	0.02	0.03
8	Sp	Mg	0-15	1.51	0.24	0.37	0.21	0.31	0.05	0.08	0.02	0.03	0.01	0.02
			0-15	1.35	0.32	0.43	0.26	0.35	0.09	0.12	0.05	0.07	0.03	0.04
9	Sp	Bb	40-50	1.34	0.28	0.38	0.25	0.30	0.07	0.09	0.03	0.04	0.01	0.02
			0-15	1.43	0.34	0.49	0.31	0.44	0.19	0.27	0.08	0.11	0.06	0.09
10	Ky	Bb	40-50	1.51	0.26	0.40	0.23	0.35	0.08	0.13	0.02	0.04	0.01	0.02
			0-15	1.46	0.28	0.41	0.23	0.34	0.07	0.10	0.04	0.06	0.02	0.03
11	Ja	Bb	40-50	1.54	0.26	0.41	0.23	0.35	0.06	0.09	0.03	0.04	0.01	0.02
			0-15	1.37	0.30	0.41	0.28	0.38	0.12	0.16	0.05	0.06	0.02	0.03
12	Mg	Mg	40-50	1.55	0.24	0.37	0.23	0.36	0.10	0.16	0.02	0.04	0.01	0.01
			0-15	1.50	0.26	0.38	0.21	0.31	0.09	0.14	0.06	0.09	0.02	0.03
13	Ky	Mg	40-50	1.52	0.26	0.40	0.22	0.33	0.08	0.12	0.04	0.05	0.01	0.02
			0-15	1.60	0.23	0.36	0.21	0.33	0.16	0.25	0.08	0.12	0.03	0.04
14	Kls	Mg	40-50	1.48	0.28	0.42	0.25	0.38	0.17	0.26	0.07	0.10	0.03	0.04
			0-15	1.51	0.26	0.39	0.22	0.33	0.15	0.22	0.07	0.11	0.02	0.03
15	J	Bb	40-50	1.54	0.25	0.39	0.22	0.34	0.14	0.22	0.04	0.06	0.02	0.03
			0-15	1.27	0.37	0.47	0.32	0.40	0.14	0.14	0.06	0.08	0.05	0.06
16	Ky	Mg	40-50	1.57	0.24	0.38	0.23	0.36	0.06	0.10	0.03	0.04	0.01	0.02
			0-15	1.42	0.30	0.42	0.26	0.37	0.11	0.16	0.05	0.08	0.03	0.04
17	G	P	40-50	1.56	0.25	0.38	0.22	0.34	0.07	0.11	0.03	0.05	0.01	0.02
			0-15	1.30	0.36	0.47	0.31	0.41	0.15	0.19	0.13	0.17	0.05	0.06
18	B	Mg	40-50	1.58	0.23	0.37	0.22	0.35	0.07	0.12	0.02	0.03	0.01	0.02
			0-15	1.28	0.34	0.44	0.32	0.41	0.22	0.28	0.13	0.17	0.06	0.08
19	Kls	Mg	40-50	1.13	0.48	0.55	0.44	0.50	0.26	0.30	0.16	0.18	0.10	0.11
			0-15	1.36	0.32	0.43	0.28	0.38	0.13	0.18	0.06	0.08	0.04	0.05
20	J	Bb	10	1.52	0.27	0.41	0.23	0.35	0.08	0.12	0.03	0.06	0.02	0.03
			200	1.57	0.24	0.38	0.24	0.38	0.11	0.17	0.03	0.05	0.03	0.05
			400	1.56	0.26	0.41	0.26	0.40	0.18	0.28	0.03	0.04	0.01	0.02
21	J	Mg	0-10	1.63	0.23	0.37	0.25	0.37	0.18	0.29	0.03	0.04	0.01	0.02
			40-50	1.61	0.24	0.39	0.23	0.37	0.08	0.13	0.04	0.06	0.02	0.03
				1.78	0.19	0.33	0.17	0.31	0.09	0.16	0.03	0.05	0.02	0.03

Notes: **Soil Systems & Types** Bassendean Dunes: G = Gavin, Ja = Jandakot, J = Joel; Spearwood Dunes: B = Beonaddy, Kg = Karrakatta Grey, Kls = Limestone, Ky = Karrakatta Yellow, Sp = Spearwood

Landuses Bb = Banksia bush, P = pines, Mg = market gardens

Soil moisture content measurement methods θ_g = by weight of soil solids (gravimetric), θ_v = per volume of soil (volumetric).

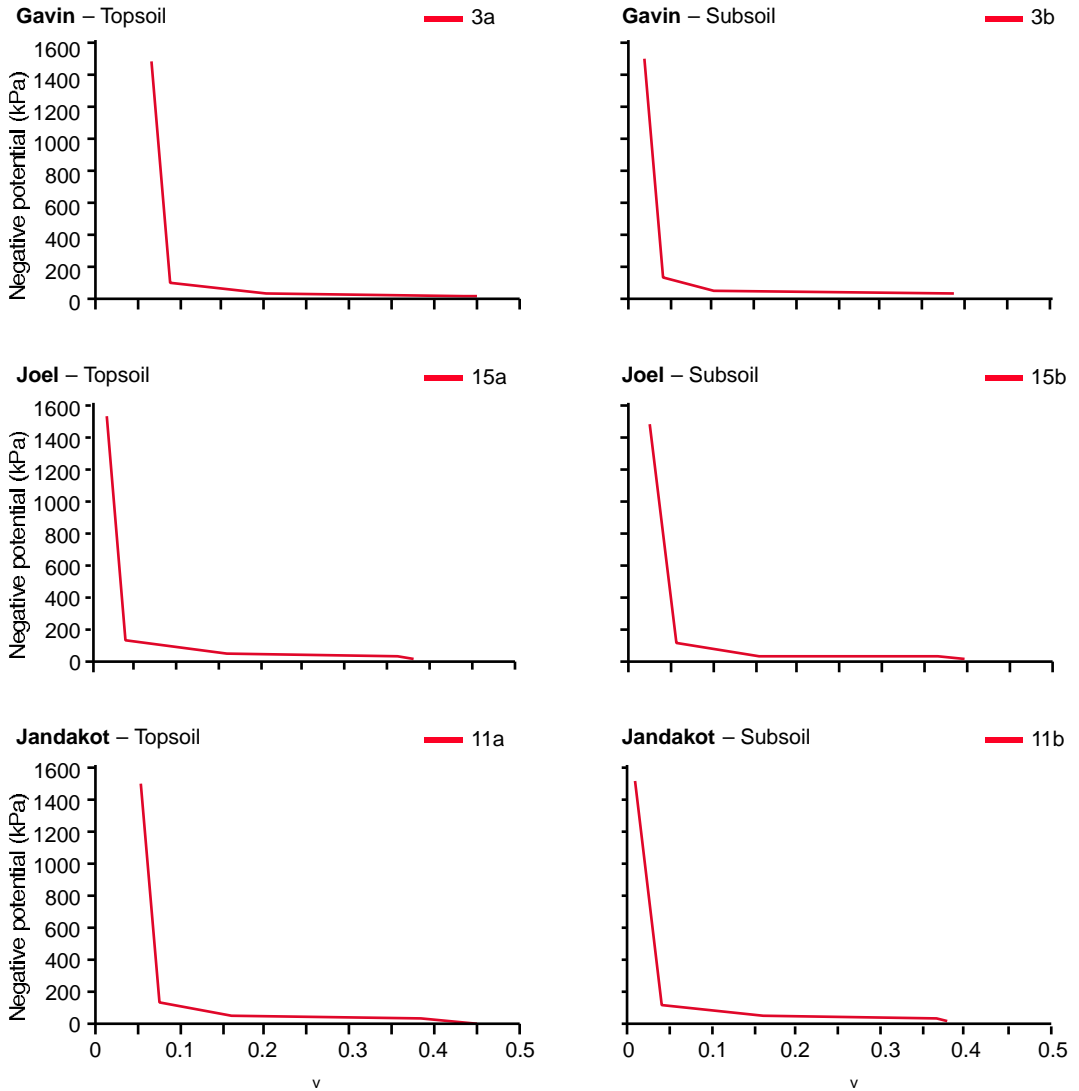

Figure 3a. Soil moisture retention (Bassendean soils).

1.7–18 % fine sand (0.063–0.18 mm), and <1.0–4 % of silt and clay (<0.063 mm). The Bassendean soils are characterised by higher percentages of coarse and medium sands, while the Spearwood soils have higher percentages of fine sand.

Soil-water retention

The soil moisture characteristic curve is strongly related to the soil texture. The greater the clay content, the greater the water retention at a particular suction. Since the Gnangara soils are mainly sandy, with relatively large pore space and low water potential (Table 3), the retention curve falls sharply with suction (Figure 3). The curves also indicate that the

soils are not compacted. Sands from the Spearwood Dune System have very little capacity to store water. Both the soil-water potential and the soil hydraulic conductivity fell rapidly with small decreases in water content. Similar results were reported earlier by Carbon et al. 1982.

Organic carbon

The organic carbon content (OC) in the Bassendean sands ranged from 0.86 per cent in clear land to 4.8 per cent in some areas under pines for the topsoil (0–10 cm); in the subsoil (40–50 cm) OC was much lower at 0.09–0.89 per cent (Table 4). In the Spearwood sand, OC was 0.57–2.5 per cent in the

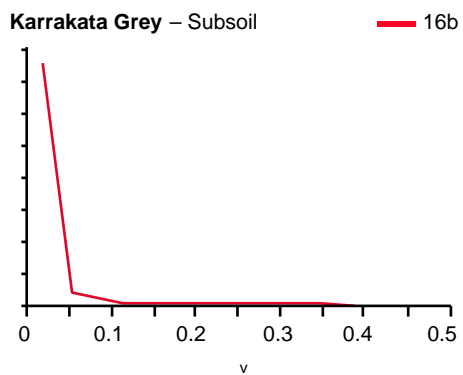
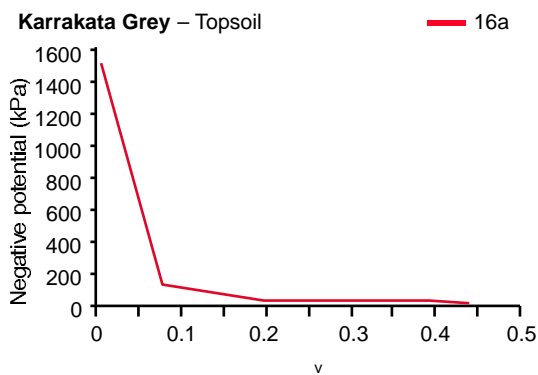
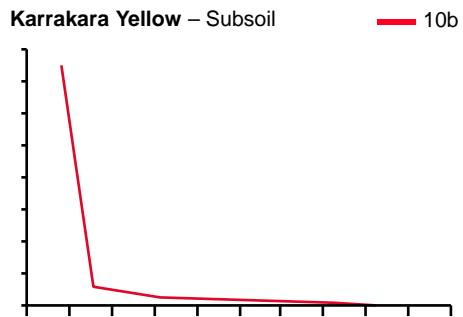
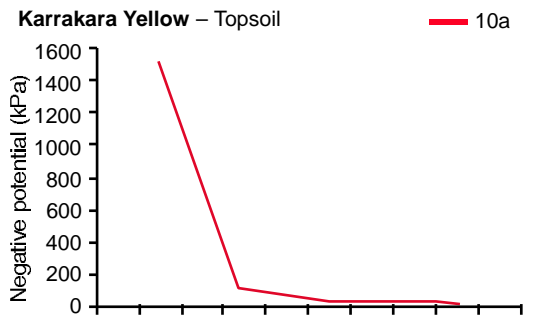
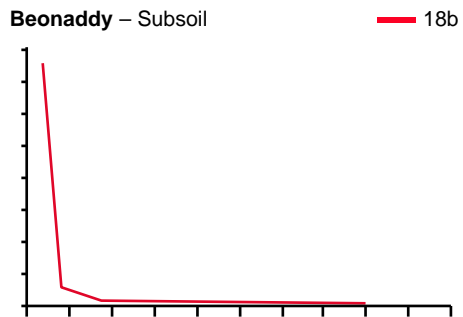
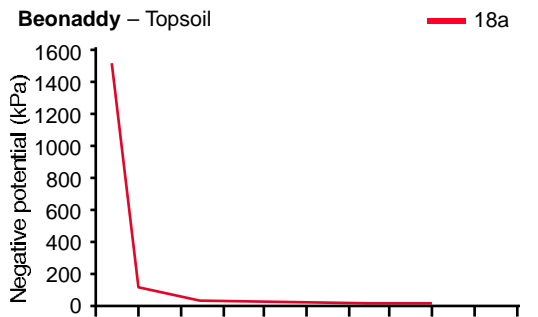
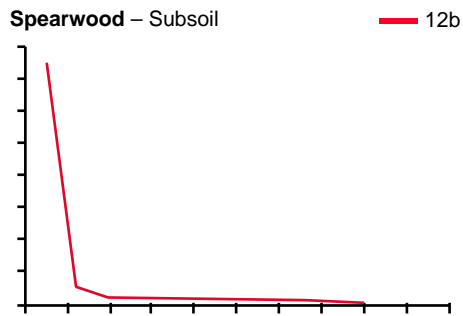
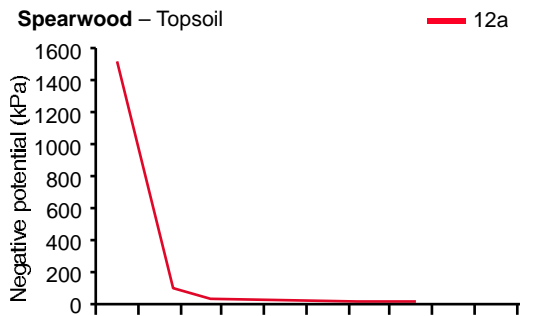

Figure 3b. Soil moisture retention (Spearwood soils).

Table 4. Soil physical properties.

Site No.	Soil-type	Landuse	Sample Depth (cm)	Organic Carbon (%)	Dry-soil Bulk Density (g/cm ³)	Porosity, E 1-(bd/2.65)	pH	Electrical Conductivity (mS/cm)
1	J	Bb	0–15	2.90	1.23	0.54	4.64	0.0237
			40–50	0.89	1.49	0.44	4.51	0.0081
2	Ja	Bb	0–15	1.02	1.46	0.45	5.00	0.0094
			40–50	0.14	1.60	0.40	5.12	0.0049
3	G	Bb	0–15	2.94	1.48	0.44	4.92	0.0389
			40–50	0.56	1.54	0.42	4.93	0.0135
4	G	Mg	0–15	1.05	1.53	0.42	4.43	0.0406
			40–50	0.09	1.55	0.42	4.39	0.0106
5	B	Bb	0–15	2.88	1.05	0.60	5.96	0.0479
			40–50	0.18	1.55	0.41	5.50	0.0199
6	G	P	0–15	4.80	1.03	0.61	4.46	0.0235
			40–50	0.66	1.49	0.44	3.91	0.0221
7	Ky	Mg	0–15	0.57	1.32	0.50	6.24	0.0354
			0–15	0.10	1.62	0.39	6.38	0.0157
8	Sp	Mg	0–15	0.78	1.45	0.45	5.61	0.0462
			40–50	0.16	1.51	0.43	6.18	0.0219
9	Sp	Bb	0–15	2.50	1.22	0.54	6.08	0.0763
			40–50	0.25	1.56	0.41	6.14	0.0239
10	Ky	Bb	0–15	0.75	1.47	0.44	5.52	0.0232
			40–50	0.28	1.54	0.42	5.62	0.0156
11	Ja	Bb	0–15	1.02	1.39	0.47	4.83	0.0220
			40–50	0.34	1.61	0.39	4.64	0.0063
12	Sp	Mg	0–1	0.85	1.64	0.38	7.19	0.0486
			40–50	0.24	1.55	0.41	7.28	0.0208
13	Ky	Mg	0–15	0.82	1.39	0.48	7.02	0.0408
			40–50	0.49	1.57	0.41	6.70	0.0389
14	Kls	Mg	0–15	0.78	1.28	0.52	7.05	0.0539
			40–50	0.29	1.56	0.41	7.15	0.0354
15	J	B	0–15	1.14	1.30	0.51	4.53	0.0166
			40–50	0.84	1.59	0.40	4.65	0.0057
16	Ky	Mg	0–15	1.13	1.49	0.44	7.00	0.0231
			40–50	0.31	1.45	0.45	7.14	0.0541
17	G	P	0–15	2.17	1.20	0.55	5.97	0.0355
			40–50	0.45	1.39	0.47	4.90	0.0177
18	B	Mg	0–15	2.16	1.48	0.44	7.16	0.0957
			40–50	3.08	1.21	0.54	7.90	0.1752
19	Kls	Mg	0–15	1.05	1.39	0.48	7.87	0.0709
			40–50	0.48	1.60	0.40	7.81	0.0588
20	J	Bb	10	0.86	1.49	0.44	4.87	0.0150
			200	0.50	1.63	0.38	5.46	0.0055
			400	0.10	1.60	0.40	5.20	0.0045
21	J	Mg	0–10	0.58	1.66	0.37	6.58	0.0575
			40–50	0.16	1.63	0.38	5.83	0.0362

Notes: Soil Systems & Types

Bassendeau Dunes: G= Gavin, Ja = Jandakot, J = Joel

Spearwood Dunes: B = Beonaddy, Kg = Karrakatta Grey, Kls = Limestone, Ky = Karrakatta Yellow, Sp = Spearwood

Landuses

Bb = Banksia bush, P= pines, Mg = market gardens.

Table 5. Hydraulic conductivity of Gnangara soils.

Site No.	Soil-type	Landuse	Sample Depth (cm)	Hydraulic Conductivity, K (m/day)
1	J	Bb	0–15	0.63
			40–50	4.26
2	Ja	Bb	0–15	1.40
			40–50	5.00
3	G	Bb	0–15	1.54
			40–50	0.41
4	G	Mg	0–15	1.12
			40–50	1.46
5	B	Bb	0–15	5.20
			40–50	3.55
6	G	P	0–15	2.32
			40–50	0.95
7	Ky	Mg	0–15	7.30
			0–15	5.33
8	Sp	Mg	0–15	3.57
			40–50	4.06
9	Sp	Bb	0–15	0.42
			40–50	3.56
10	Ky	Bb	0–15	1.26
			40–50	5.69
11	J	Bb	0–15	0.57
			40–50	5.27
12	Sp	Mg	0–15	2.99
			40–50	2.99
13	Ky	Mg	0–15	2.78
			40–50	1.82
14	Kls	Mg	0–15	4.23
			40–50	2.26
15	J	Bb	0–15	1.86
			40–50	3.30
16	Ky	Mg	0–15	2.26
			40–50	5.06
17	G	P	0–15	2.67
			40–50	7.21
18	B	Mg	0–15	2.05
			40–50	0.38
19	Kls	Mg	0–15	6.38
			40–50	4.41
20	J	Bb	10	4.75
			200	3.94
			400	3.67
21	J	Mg	0–10	1.48
			40–50	3.09

Note: Soil systems, soil-types and landuses as for Table 4.

topsoil (0–10 cm), and 0.1 to 0.82 in the subsoil. In the Beonaddy soils, which are associated with swampy regions, OC was higher ranging from 2.16 per cent in the topsoil to 3.0 per cent in the subsoil.

Hydraulic conductivity

Hydraulic conductivity measurements were carried out at 21 sites, at two depth intervals, using topsoils (0–10 cm) and subsoils (40–50 cm) (Table 5). The results of the first set of measurement of hydraulic conductivity gave comparatively lower values than the ones recorded in the literature (Carbon 1973), so a repeat of the test was made at all sites. The results from both tests were identical and showed that the hydraulic conductivities were low. The results also show that the hydraulic conductivity of the topsoil is lower than the subsoil. Although the Bassendean sands have higher hydraulic conductivities, the results also show that there are not big differences in the hydraulic conductivity between the Bassendean and the Spearwood sands. Hydraulic conductivity ranges from 0.56 to 2.85 m/day for the topsoils and 3.41 to 6.38 m/day in the subsoils.

Geomorphological mapping

Landform reflects the combined effects of the hydrological, erosional and depositional processes which take place in an area. Given similar cover and climatic conditions, lithology and soil characteristics control the rate of infiltration. A change of lithology within a slope is often reflected in the slope form, which in turn will affect surface processes as the slope configuration becomes more complex.

Recent advances in the capabilities of geographic information systems (GIS) in collating and processing spatial data have revolutionised mapping concepts. It is now possible to produce maps objectively and produce dynamic geomorphic maps using GIS-based analytical and modelling capabilities to manipulate spatial data to any required scale and for any configuration or combination of attributes such as slope, aspect and curvature. This makes static mapping obsolete. The objectives of geomorphological mapping can be summarised as:

- identify similar areas in the landscape that have similar topographic characteristics
- use these units as the basis for the hydrogeomorphic mapping
- model the hydrogeomorphic map to provide a systematic basis for the derivation of more complex hydrogeological units.

Discussion

Comparison of soil landscape with geomorphological mapping, and its relationship with soil genesis

The great Mindel-Riss Interglacial epoch occurred about 240 000 years ago. Maximum sea-level during the Riss-Wurm Interglacial has been put at about 8m higher than the present day, with some estimates as high as double that (McArthur and Bettenay 1960). It has been suggested that deposition to form the Pinjara Plain as it is today began with the retreat of the sea following the Mindel-Riss Interglacial. The Bassendean dune system, the oldest of the three dune systems, may have begun at the RissI-RissII Interstadial; however, the main accumulation took place in the Riss-Wurm interglacial period over 100 000 years. Following the Bassendean dunes, there was apparently a considerable break before the accumulation of the Spearwood dune system, which is totally different in topography and composition and must be regarded as very youthful by comparison. Accumulation of this system began in the Wurm I Interstadial. The Quindalup dune system is associated with a falling sea-level. The relatively young age of the dune systems suggest that several interrelated processes of weathering which took place since their deposition are still ongoing today.

The geomorphology of the Ngarara Mound may be depicted as consisting of the degraded surface of aeolian origin of the Bassendean Dunes in the east and the Spearwood Dunes in the west, with pockets of parabolic and nested-parabolic dune complex (Quindalup dunes) along the shore. This geomorphological classification can be mechanically performed using GIS techniques by classifying the elevation (from digital elevation data) into three main divisions and superimposing the highly undulating Quindalup along the shoreline. The Quindalup can be distinguished in the GIS by its characteristic form and slope pattern.

Table 6. Hydrogeomorphic units corresponding to the soil-types.

Soil-type	Hydrogeomorphic Units (HGU)
Gavin	61,62,71
Jandakot	72,82,83,91,92,93
Beonaddy	12
Karrakatta	43,53,63
Limestone/Spearwood	22,32,33
Quindalup	11,23,24
alluvial	41,42
waterbodies & swamps	51,52

A detailed classification of the hydrogeomorphic elements used for this study is based on nine elevation classes (10, 20, ..., 80 and >80 m) and three slope classes (<0.4°, 0.4–1.8° and 3.0–1.8°). This resulted in 27 hydrogeomorphic elements, which were correlated with the units of the soil maps. The final map was prepared by combining similar elements based on either similar elevation or similar slopes to reduce the number of elements. This was achieved by giving similar colours to the assigned units. This resulted in eight hydrogeomorphic units as shown in Table 6. The hydrogeomorphic unit (HGU) map is shown as Figure 4.

The soils of the Bassendean Dunes are Podsoles, those of the Spearwood Dunes are podsolised sands, and the Quindalup Dunes are undifferentiated calcareous sands. In the most easterly and oldest parts of the Bassendean Dunes, the humus podsoles, typified by the Gavin series, are dominant. Proceeding westward, the incidence of iron-humus podsoles (Jandakot series) becomes higher. In the Spearwood Dunes, the depth of sand overlying aeolianites is greater on the eastern edge (Karrakatta series) and show a well-defined lower horizon within the topsoil. In the Quindalup System, there is more uniform carbonate near the shore and concentration of carbonate in the lower horizons (McArthur and Bettenay 1960).

Lakes, swamps and low-lying areas mapped by the hydrogeomorphic techniques looked similar to the existing features; the main differences were associated with the undulating Spearwood and the lower ranges of the Bassendean. Due to similar elevation ranges in parts of the Spearwood were mapped as Bassendean. Similar problems are associated with the low-lying areas in the Spearwood which were within ranges of the same elevation as those in the alluvial area in the eastern parts of the catchment.

The results of the mapping show that the distribution of hydrogeomorphic units (HGUs) in the catchment is controlled by the geological formations on which they were developed. The weathering characteristics of each of the geological formations led to the development of a certain HGU. For example, the Bassendean sands are developed in the higher parts of the landscape, and the Spearwood sands are developed at the break of slope of the Bassendean sands. The series of lakes extending in the north-south line are also at the break of slope. The Quindalup sands near the shore are characterised by parabolic and nested-parabolic dune complexes. At the same time, slope, break of slope and curvature control where groundwater will discharge. In most cases, this coincided with the series of lakes and swamps that extend along the north-south line within the Spearwood sands.

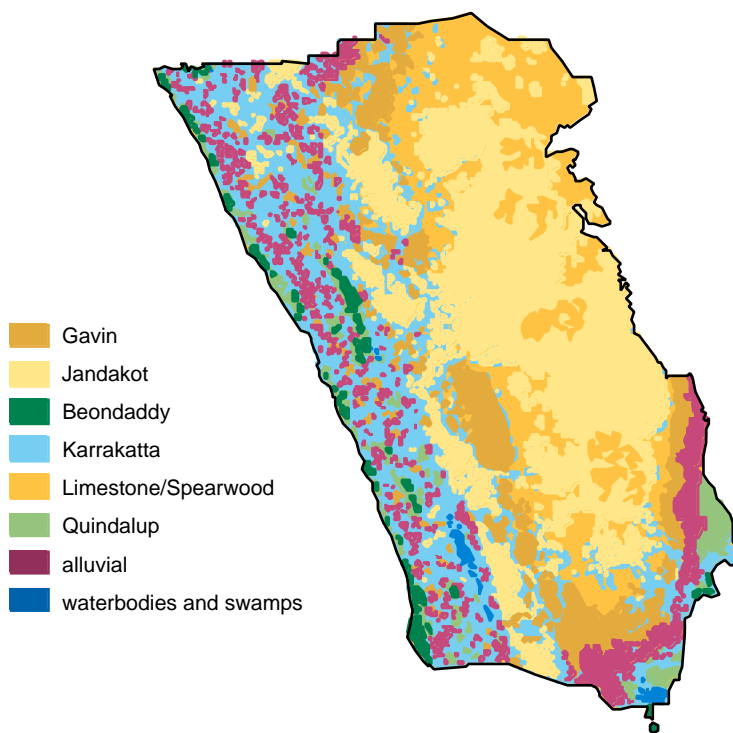

Figure 4. Gngangara Mound HGUs.

Soil characteristics of the Gngangara Mound that control pesticide leaching

Pesticide sorption in soils is dependent on both the type of pesticide and the physical and chemical characteristics of soils, including the types of minerals present. The thickness of soils, especially the topsoil which contains most of the organic matter and biota, determine the length of travel time that the contaminants will take to pass through this layer. Organic material, clays and other minerals react with the contaminants to absorb, react with or volatilise the chemicals. The soil physical characteristics and hydraulic properties influence the rate at which water infiltrates through the soil profile. Based on this, Bassendean sands would have lower filtering capacity than Spearwood sands. The Quindalup sands would have the lowest filtering capacity, especially in areas with shallow soil cover underlain by limestone. Two other important soil factors controlling the interactions are soil pH and soil solution composition.

Pesticide-organic matter interaction

Interaction between pesticides and soil organic matter occurs in two main ways: specific interaction between soil organic matter and pesticides leading to the formation of definite bonding and partitioning and formation of new compounds; and physical sorption

leading to the formation of thermodynamically-stable compounds. In tropical soils that are generally low in organic carbon, both the clay fraction and organic carbon may play an important role in controlling pesticide sorption.

The Gavin soils have high filtration potential due to the relatively high organic carbon content. The Spearwood and Jandakot sands have lower filtration capacity due to their lower carbon content and the Karrakatta soils have the least capacity for filtering pesticides due to their very low carbon content.

Soil pH

McArthur and Bettenay (1960) summarised the changes that occur in soils of the dune system with continued leaching of a highly calcareous sand. Progressive loss of carbonate, first from the surface and then completely, took place over 100 000–200 000 years. The losses of carbonate lead to a two-unit fall in pH and an increase in the calcium/magnesium ratio in the residual aeolinite. There is progressive loss of iron with more effective removal in the wetter and less-drained areas. After the complete removal of carbonate, an organic lower horizon develops and the pH falls by a further unit.

Beside the difference in organic carbon with soil-type, there are also marked differences due to

landuse. The soils under market gardens were near neutral pH, whereas those under natural vegetation were generally acidic in reaction, with some as low as pH 4. Soil pH effects are important with weakly basic (triazine) and acidic (phenoxy acid) pesticides because the relative quantities in ionic form are dependent on the pK of the pesticide and pH of the soil system. Weakly basic pesticides become cations at low pH. In variable charge soils, such pH values lead to low surface negative charge and high positive charge that result in increased sorption. In contrast, the acidic pesticides ionise to anionic form as pH increases (one or more pH units above the pKa of acid) (Weber 1993). There are some reports of increasing sorption of some pesticides with decreasing pH, as is the case in this study in the topsoils under native vegetation and pines.

Soil solution composition

Interaction between contaminants and soil particles takes place at the solid-solution interface. Thus the water content of the soil and chemistry of the soil water influence the solubility of the pesticides, interaction with the chemicals and minerals in the water, and the rate with which the interstitial water is moving downward or laterally, or both.

The soils and interstitial water in the Quindalup and Spearwood Sand systems are mainly high in pH and in alkaline material, whilst the Bassendean Sands are lower in pH. Weakly basic pesticides become cations at low pH; such pH values lead to low surface negative charge and high surface positive charge resulting in increased sorption. On the other hand, the acidic pesticides ionise to anionic form as pH increases, and this may lead to reduced sorption with increasing pH.

Conclusions

Physical, chemical and hydraulic characteristics of topsoil (0–15 cm) and subsoil (40–50 cm) were carried out at 21 sites in the southern part of the Gnangara Mound, representing the major soils under the different landuse in the area. The results show that Bassendean Sands have higher coarse sand particles and consequently higher hydraulic conductivity than Spearwood Sands. The Bassendean Dunes generally have low relief; minor variations in topography translate into variable depths to watertable, which are the basis for division into soil mapping units. For example the Gavin soil has higher organic carbon content than all other soils sampled. The Spearwood Dunes are divided mainly on the depth of soil over the limestone substrate and the incidence of karst features.

The Spearwood and Jandakot soils have lower coarse sand and lower carbon content, while the Karrakatta soils have the least amount of organic carbon.

Detailed soil maps were compared with GIS-produced hydrogeomorphic maps. The results show that the hydrogeomorphic maps can be used in the absence of detailed soil maps to classify the catchment into areas with similar soil characteristics.

Filtering capacity of the soils is dependant on organic material, clays and other minerals. Based on these criteria, Spearwood Sands have the highest filtering capacity, followed by Bassendean and Quindalup.

References

- Carbon, B.A. 1973. Some aspects of soil-plant water relations in a coarse soil. MSc Thesis, University of Western Australia.
- Carbon, B.A., Roberts, F.J., Farrington, P. and Beresford, J.D. 1982. Deep drainage and water use of forests and pastures grown on deep sands in a Mediterranean environment. *Journal of Hydrology* 55: 53–64.
- McArthur, W.M. and Bettenay, E. 1960. The development and distribution of the soils of the Swan Coastal Plain, Western Australia. Soil Publication No 16, CSIRO, Melbourne.
- Roberts, F.J. and Carbon, B.A. 1971. Water repellence in sandy soils of south-western Australia. 1. Some studies related to field occurrence. *Field Station Record*. CSIRO Division of Plant Industry: 13–20.
- Topp, G.C., Galganov, Y.T., Ball, B.C. and Carter, M.R. 1993. Soil water desorption curves. *In*: Carter, M.R., ed., *Soil Sampling and Methods of Analysis*. Lewis Publishers, Florida: 569–580.
- Weber, J.B. 1993. Ionization and sorption of fomesafen and atrazine by soils and soil constituents. *Pesticide Science* 39: 31–38.
- White, R.E. 1997. *Principles and Practice of Soil Science: The Soil as a Natural Resource*. 3rd ed. Blackwell Science, Oxford.

Sorption of Selected Pesticides and their Metabolites in Soil Profiles of the Swan Coastal Plain

R.S. Kookana¹, A. Kerekes¹, D. Oliver¹, R.B. Salama² and J.D. Byrne²

Abstract

A study was conducted to estimate the sorption of nine different pesticides in 23 soils of the Swan Coastal Plain of Western Australia. Surface and sub-surface soils were collected from several sites under native vegetation (Banksia woodland) and under market gardens around Perth. Sorption was measured by a batch equilibration method employing a single-solution concentration. The sorption coefficients (K_d) were calculated assuming a linear relation between solution and sorbed concentrations. The pesticides studied included atrazine and its two main metabolites (desethylatrazine and desisopropylatrazine), fenamiphos and its two main metabolites (sulfoxide and sulfone), fenarimol, azinphos methyl and prometryn. The soils studied showed a wide range of sorption capacities for pesticides. While a general trend of higher sorption with higher organic matter content of the soil was apparent, organic carbon alone could not explain the differences. The metabolites of atrazine and fenamiphos had much lower sorption affinities for soils than their respective parent compounds. The metabolites of fenamiphos had an order-of-magnitude lower sorption than their parent compound in some soils. Given that these metabolites are equally toxic in nature and more persistent than their parent compounds, the potential of the metabolites themselves to pollute groundwater should be taken into account. For most soils the K_d values for desisopropylatrazine were the lowest, and azinphos methyl the highest. The pesticides in descending order of sorption were: azinphos methyl > fenarimol > prometryn > fenamiphos > atrazine > fenamiphos sulfone > fenamiphos sulfoxide > desethylatrazine > desisopropylatrazine. The sorption per unit mass of organic carbon in soils (K_{oc}) showed a wide variation among the soils studied, possibly reflecting the varying nature of organic materials present in the soils. The sorption coefficients for pesticides were much lower in subsoils than in surface soils; in some cases they were negligible in subsoils. This suggests that in such soils, once the pesticide leaches beyond the top 50–100 cm, it can move with the water-front with little retardation through sorption.

INTENSIVE AGRICULTURE relies heavily on the use of pesticides to control weeds, insect pests and diseases. Continuous use of pesticides has caused contamination of surface and ground water in several parts of the world, including Australia (Vighi and Funari 1995; Kookana, Phang and Aylmore 1997). A recent monitoring study on groundwaters of several regions of Australia has revealed the presence of pesticide residues at trace levels (Bauld 1996). This is of concern to the community, especially in areas where groundwater is used for drinking or domestic use. Several rural and urban centres of Australia rely heavily on groundwater for drinking purposes. For example, nearly two thirds of the drinking water

supply in metropolitan Perth is extracted from groundwater. It is therefore imperative that such groundwater sources are protected from contamination.

Pesticides are commonly used for vegetable production, often with several applications, in the market gardens on the Gnangara Mound in the Swan Coastal Plain. This study was carried out to assess the mobility of pesticides through selected soil profiles of the area. Sorption is a key factor in controlling pesticide move-

¹ CSIRO Land and Water, Private Bag No 2, Glen Osmond, South Australia 5064

² CSIRO Land and Water, Private Bag No 5, PO Wembley, Western Australia 6913

ment through soils to the groundwater. The study objectives were therefore to:

- estimate the extent of sorption of commonly-used pesticides, through profiles representing different soil-types in the area, and
- provide the sorption coefficient as an input parameter for the assessment of groundwater vulnerability in the Swan Coastal Plain.

Materials and Methods

Soils

Twenty-three surface and sub-surface soils were sampled from 11 sites in the Gnangara Mound. The samples were mostly taken at 0–15 or 40–50 cm, and one site required sampling at 200 and 400 cm. The soils were air-dried, ground and sieved through a 2 mm sieve before determining their physico-chemical properties. The properties of the soil profiles are shown in Table 1. From the point of view of sorption of pesticides to soil, the key soil property is the organic carbon content (OC). As expected, OCs of sub-surface layers were much lower than those of the

surface layers (in some cases down to ten per cent). The soils under intensive horticulture (market gardens) had lower OC than those under native vegetation. The other key difference among soils was the pH. The soils under market gardens were near neutral, whereas those under natural vegetation were generally acidic with some as low as pH 4.

Pesticides

The pesticides in the sorption study were selected from the list of commonly-used pesticides on the basis of their persistence and likely pollution potential for the groundwater in the study area. They were, as shown in Table 2:

- atrazine (and its two main metabolites desethylatrazine (DEA) and desisopropylatrazine (DIA))
- fenamiphos (and its two main metabolites fenamiphos sulfoxide (FS) and fenamiphos sulfone (FSO))
- fenarimol
- azinphos methyl
- prometryn.

Table 1. Physical and chemical properties of the soils used in the study.

Sample No.	Site No.	Soil-type	Landuse	Sample Depth (cm)	OC (%)	Dry-soil Bulk Density (g/cm)	Porosity, E (1-(bd/2.65))	pH	Electrical Conductivity (mS/cm)
1	1	J	Bb	0–15	2.90	1.23	0.54	4.64	0.0237
2				40–50	0.89	1.49	0.44	4.51	0.0081
3	2	Ja	Bb	0–15	1.02	1.46	0.45	5.00	0.0094
4				40–50	0.14	1.60	0.40	5.12	0.0049
5	3	G	Bb	0–15	2.94	1.48	0.44	4.92	0.0389
6				40–50	0.56	1.54	0.42	4.93	0.0135
7	6	G	P	0–15	4.80	1.03	0.61	4.46	0.0235
8				40–50	0.66	1.49	0.44	3.91	0.0221
9	9	Sp	Bb	0–15	2.50	1.22	0.54	6.08	0.0763
10				40–50	0.25	1.56	0.41	6.14	0.0239
11	13	Ky	Mg	0–15	0.82	1.39	0.48	7.02	0.0408
12				40–50	0.49	1.57	0.41	6.74	0.0389
13	15	J	Bb	0–15	1.14	1.30	0.51	4.53	0.0166
14				40–50	0.84	1.59	0.40	4.65	0.0057
15	16	Ky	Mg	0–15	1.13	1.49	0.44	7.00	0.0231
16				40–50	0.31	1.45	0.45	7.14	0.0541
17	18	B	Mg	0–15	2.16	1.48	0.44	7.16	0.0957
18				40–50	3.08	1.21	0.54	7.94	0.1752
19	19	Kls	Mg	0–15	1.05	1.39	0.48	7.87	0.0709
20				40–50	0.48	1.60	0.40	7.81	0.0588
21	20	J	Bb	10	0.86	1.49	0.44	4.87	0.0150
22				200	0.50	1.63	0.38	5.46	0.0055
23				400	0.10	1.60	0.40	5.20	0.0045

Notes: Soil Systems & Types

Bassendean Dunes: G= Gavin, Ja = Jandakot, J = Joel

Spearwood Dunes: B = Beonaddy, Kg = Karrakatta Grey, Kls = Limestone, Ky = Karrakatta Yellow, Sp = Spearwood

Landuses

Bb = Banksia bush, P= pines, Mg = market gardens.

Table 2. Key properties of the pesticides used in this study (metabolites not shown).

Common name	Class	pKa	Solubility at 25°C (mg/L)	Half-life (days)	Log K_{ow}
atrazine	s-triazine herbicide	1.68	33	60	2.50
fenamiphos	organophosphate insecticide and nematocide	–	400	50	3.30
fenarimol	fungicide	–	4	360	3.69
azinphos methyl	organophosphate insecticide	–	29	10	2.96
prometryn	s-triazine herbicide	4.05	33	60	3.10

Note: half-life calculations after Wauchope et al. 1992.

Sorption measurement

Due to the large number of soils studied, a single-point sorption measurement was made as an approximate measure of pesticide sorption. The sorption coefficient (Kd) was calculated from the ratio of sorbed concentration to the soil solution concentration after equilibration. The soils were weighed out in triplicate (5 g) into centrifuge tubes, and to each tube was added 10 ml of 0.005M Ca(NO₃)₂ solution spiked with a known concentration of pesticide. The single concentration used during the sorption study for all pesticides was 2 mg/L. Soil suspensions in the centrifuge tubes were shaken for four hours on an end-over-end shaker, then centrifuged at 2000 rpm for five minutes before the supernatant was decanted. The supernatant was filtered through 0.45 µm acrodisk filters, then analysed on a High Performance Liquid Chromatograph (HPLC).

Pesticide analysis

The concentrations of pesticides in the supernatants after equilibration were measured on a Varian HPLC equipped with a Star 9012 ternary gradient pump, Polychrom 9065 diode array detector (PDA), Star 9050 programmable variable-wavelength UV detector, an auto-injector, column oven, and a Star 9100 auto-sampler with electric sample valve. Data were collected and processed on the Star HPLC data system.

Atrazine and metabolites (DEA and DIA) and azinphos methyl

Waters radial pak liquid chromatography C₁₈ cartridges (10 cm x 5 mm ID, 4 µm particle size); gradient elution with mobile phase 90:10 H₂O:CH₃CN for first two minutes, which then changes over for the following five minutes to 50:50 H₂O:CH₃CN and is maintained at this composition for the next eight minutes; flow rate 1.0 mL/min; UV-Vis detector wavelength 220 nm; retention times: DEA, 6.2 minutes; DIA, 7.4 minutes; atrazine, 10.0 minutes; azinphos methyl, 13.5 minutes.

Fenamiphos, fenamiphos sulfoxide and fenamiphos sulfone

C₁₈ column (25 cm x 4.6 mmID); isocratic elution with mobile phase 50:50 H₂O:CH₃CN; flow-rate

1 mL/min; PDA detector wavelength: fenamiphos sulfoxide and fenamiphos sulphone 224 nm and 248 nm; retention times: fenamiphos sulfoxide, 4.5 minutes; fenamiphos sulphone, 7.4 minutes; fenamiphos, 15 minutes.

Fenarimol and prometryn

C₁₈ column (25 cm x 4.6 mmID); isocratic elution with mobile phase 30:25:45 H₂O:CH₃CN:CH₃OH; flow rate 0.8 mL/min; PDA detector wavelength: fenarimol, 220 nm and prometryn 244 nm; retention times: fenarimol, 10.2 minutes; prometryn, 12.2 minutes.

Results

For the nine pesticides studied here, for any given soil, the atrazine metabolite DIA showed the lowest Kd and azinphos methyl the highest. Generally, the pesticides followed the following order of descending sorption: azinphos methyl > fenarimol > prometryn > fenamiphos > atrazine > fenamiphos sulfone > fenamiphos sulfoxide > DEA > DIA (Table 3).

The highest Kd for azinphos methyl is not consistent with the scale of hydrophobicity. In fact, among the nine compounds studied, fenarimol was the most hydrophobic and was expected to result in highest Kd values. While in several soils the Kd values of the two compounds were similar, in some other soils azinphos methyl showed a higher sorption coefficient.

Atrazine, DEA and DIA

The soils differed greatly in their sorption affinity for atrazine and its two metabolites. For example, Kd values for atrazine were 0.0–18.7 L/kg, for DEA 0.0–12.0 L/kg, and for DIA 0.0–9.8 L/kg. The highest Kd for the three compounds was found in surface soil (0–15 cm) from Profile 6 of Gavin soil under pines; by contrast, the sub-surface layers of Profile 20 of Joel soil (at 200 and 400 cm) showed no sorption. Not all sub-surface soils were low in organic matter content; indeed, the sub-surface layer of Beonaddy soil (Profile 18) had higher organic matter content than the surface layer (3.08 compared with 2.16 per cent), and Kd values were higher accordingly.

Table 3. Sorption coefficients (Kd, in L/kg) of pesticides in various soils.

Profile No.	Soil-type	Land-use	Sample Depth (cm)	OC (%)	Sorption Coefficient									
					A	DEA	DIA	F	FS	FSO	FL	AM	P	
1	J	Bb	0-15	2.90	10.64	7.52	5.85	>40	6.20	8.58	>50	>50	>70	
			40-50	0.89	4.19	2.36	2.00	28.30	2.42	2.54	49.72	>50	>70	
2	Ja	Bb	0-15	1.02	1.41	1.13	1.00	7.87	0.57	0.42	24.95	39.40	8.78	
			40-50	0.14	0.05	0.25	0.30	0.19	0.10	0.00	2.56	0.70	0.68	
3	G	Bb	0-15	2.94	5.22	2.96	2.61	28.19	3.12	3.37	49.33	>50	32.01	
			40-50	0.56	0.94	0.59	0.63	7.75	0.84	0.59	17.47	24.90	12.39	
6	G	P	0-15	4.80	18.72	11.98	9.79	>40	9.89	15.73	>50	>50	>70	
			40-50	0.66	2.56	1.16	1.18	18.45	1.66	1.13	>50	>50	29.11	
9	Sp	Bb	0-15	2.50	1.70	1.26	1.05	9.34	0.00	0.72	>50	>50	6.61	
			40-50	0.25	0.10	0.35	0.39	0.47	0.00	0.12	3.84	1.31	0.46	
13	Ky	Mg	0-15	0.82	0.55	0.79	0.64	4.81	0.18	0.67	21.57	27.91	1.54	
			40-50	0.49	8.38	0.93	0.67	3.90	0.08	0.58	20.26	41.66	1.86	
15	J	Bb	0-15	1.14	10.37	5.64	5.05	>40	5.07	7.89	>50	>50	>70	
			40-50	0.84	3.05	1.30	1.29	21.37	0.75	1.87	42.93	>50	32.99	
16	Kg	Mg	0-15	1.13	0.78	0.85	0.75	10.32	0.27	0.88	9.13	44.68	2.00	
			40-50	0.31	0.24	0.54	0.47	1.73	0.00	0.28	4.82	5.08	0.58	
18	B	Mg	0-15	2.16	1.26	1.74	1.13	16.51	0.76	1.65	27.25	>50	2.72	
			40-50	3.08	3.26	4.65	2.49	33.04	3.01	3.62	34.65	>50	5.09	
19	KLS	Mg	0-15	1.05	0.62	0.69	0.60	5.72	0.17	0.57	21.71	26.86	1.75	
			40-50	0.48	0.25	0.46	0.40	3.92	0.08	0.53	7.21	7.44	1.06	
20	J	Bb	0-10	0.86	1.73	1.62	1.19	5.45	0.42	1.14	12.32	>50	12.56	
			200	0.50	0.00	0.00	0.00	0.00	0.00	0.00	0.79	0.05	0.04	
			400	0.10	0.00	0.00	0.00	0.00	0.00	0.00	0.16	0.00	0.00	

Notes: **Soil-types**

B = Beonaddy, G = Gavin, J = Joel, Ja = Jandakot, Kg = Karrakatta Grey, KLS = Limestone, Ky = Karrakatta Yellow, Sp = Spearwood

Landuses

Mg = market gardens, P= pines, Bb = Banksia bush

Pesticides

A = atrazine, DEA= desethylatrazine, DIA= desisopropylatrazine, F = fenamiphos, FS = fenamiphos sulfoxide,

FSO = fenamiphos sulfone, FL= fenarimol, AM = azinphos methyl, P= prometryn

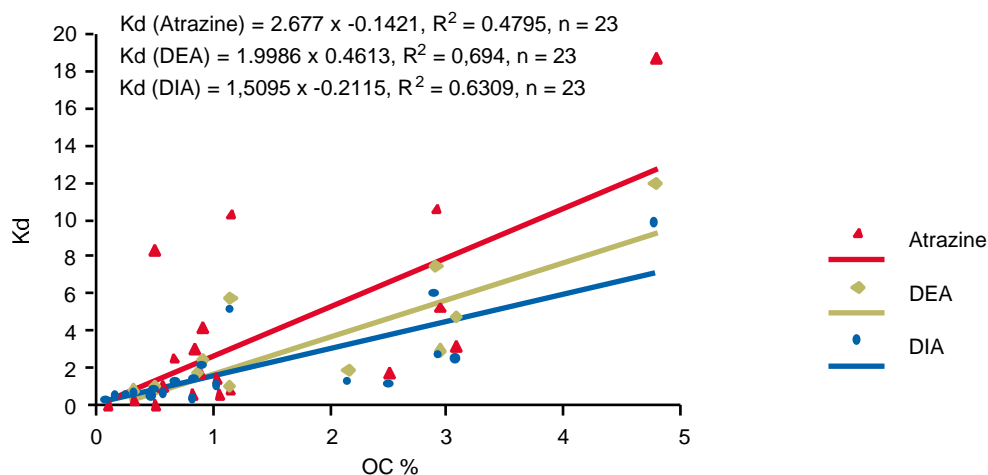

Figure 1. Relationship between sorption coefficient (Kd) of atrazine and its two metabolites (DEA and DIA) and organic carbon (OC).

Fenamiphos, fenamiphos sulfoxide and fenamiphos sulfone

Fenamiphos showed the highest sorption coefficient followed by its two metabolites FS and FSO. For example, K_d values for fenamiphos ranged from 0.0 to >40 L/kg, whereas for FS and FSO ranged from 0.0 to 15.7 L/kg. As was observed in the case of atrazine and its metabolites, the highest K_d values for the three compounds were found in the surface soil (0–15 cm) from Profile 6 of Gavin soil. The sub-surface K_d values were always lower than the corresponding values for the surface layer, due to lower organic carbon content of the sub-surface soils. However, as with the sorption of atrazine and its metabolites, the K_d values of the three compounds in the Beonaddy soil were higher in the sub-surface layer, due to a higher organic matter content. There was negligible sorption of fenamiphos and the metabolites in the Joel soil. For the two metabolites, the K_d values in several sub-surface layers were very low.

Fenarimol, azinphos methyl and prometryn

Sorption of fenarimol and azinphos methyl in most of the surface soils was very high, especially those under Banksia bush or pines. In most surface soils, sorption was so high that, after equilibration, the concentrations of the pesticides left in soil solutions were below the limits of detection. Hence the actual K_d values could not be calculated and these have been reported as greater than a certain value (for example >50 L/kg for azinphos methyl). The K_d values for fenarimol were lower and measurable in Jandakot Profile 2 and Joel Profile 20 under the same landuse, because of a lower organic carbon content of the surface soils. In Joel Profile 20, the soil samples from 200 and 400 cm showed virtually no sorption for these pesticides, despite the high inherent sorption affinity of pesticides such as azinphos methyl. In the case of prometryn, the sorption was not as high as for the other two compounds for any given soil. In terms of sorption affinity, the three pesticides followed the order: azinphos methyl > fenarimol > prometryn.

Discussion

A comparison of sorption of parent compounds and metabolites

For both atrazine and fenamiphos, the K_d values of the metabolites were much lower than those of the respective parent compounds. Sorption of both parent and metabolite decreased in the following order: atrazine > DEA DIA and fenamiphos > FSO FS. These results are consistent with the polarity of the compounds. In both cases, the metabolites are more polar than their parent compounds, making the metabolites more soluble in water and therefore

more mobile. This is consistent with other published studies on sorption of these compounds (Lee, Green and Apt 1986; Kookana, Phang and Aylmore 1997). From the point of view of environmental impact and toxicity, the metabolites assume considerable importance, especially in the case of fenamiphos, where the metabolites FS and FSO are as equally toxic and active against the pests as the parent compound. Given that, due to lower sorption than their parents, the metabolites are much more mobile, they deserve to be taken into account in any assessment of groundwater pollution potential of these pesticides.

Effect of landuse on sorption of pesticides

The soils under intensive cultivation (market gardens) had lower K_d for the pesticides than those under Banksia bush or pines. This is generally reflected in the organic carbon contents of the soils, which tended to be lower in the market garden soils. A comparison of soils with similar organic carbon under natural vegetation (Banksia bush) and intensive cultivation (market gardens) showed that the sorption was comparable for some pesticides and not for others. For example, surface soils of Profile 2 (Jandakot) under Banksia bush and Profile 16 (Karrakatta Grey) under market gardens both had about one per cent OC, and therefore K_d s for several pesticides were comparable. However, in the case of fenarimol and prometryn, the Jandakot soil under Banksia bush showed substantially higher K_d values than the Karrakatta Grey soil. A similar pattern is observed when the surface soils from Profile 9 of Spearwood (under Banksia bush) and Profile 18 of Beonaddy (under market gardens) are compared.

The reasons for the difference in sorption of fenarimol and prometryn for these soils may be linked to the differences in other soil properties such as pH. Indeed the pH of soils under market gardens were near neutral, whereas all other soils were acidic. Soil pH can influence the sorption of ionizable pesticides such as prometryn and atrazine, both of which are weakly basic in nature.

Relationship between K_d and organic carbon

Despite similar solubilities of prometryn and atrazine, the K_d values for prometryn were generally higher. This is likely to be due to greater sensitivity of prometryn to pH differences, resulting from its higher pKa, as shown in Table 2.

The relationship between sorption and organic carbon was explored further by plotting the K_d of atrazine and fenamiphos (and their respective metabolites) against organic carbon (Figures 1 and 2).

The data in the two figures show a trend of increasing sorption with increasing organic carbon content, but a considerable scatter is evident for all

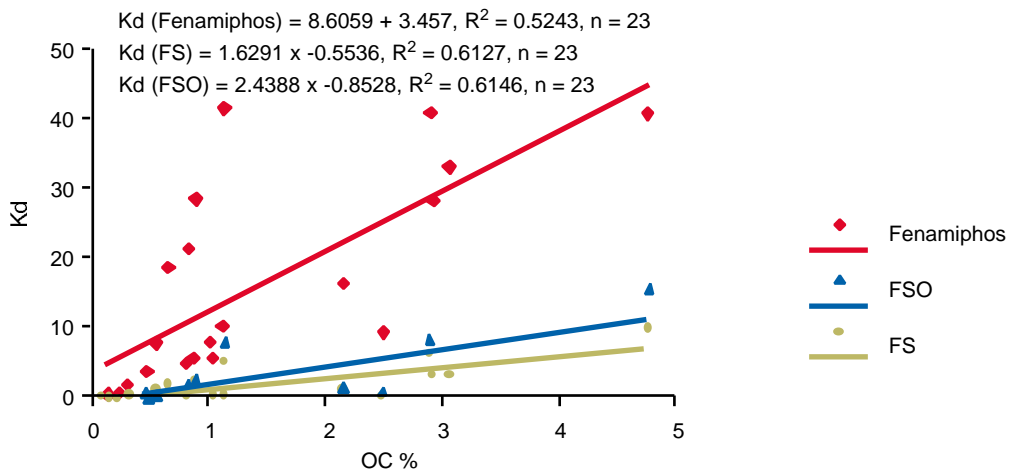

Figure 2. Relationship between sorption coefficient (K_d) of fenamiphos and its two metabolites (FSO and FS) and organic carbon (OC).

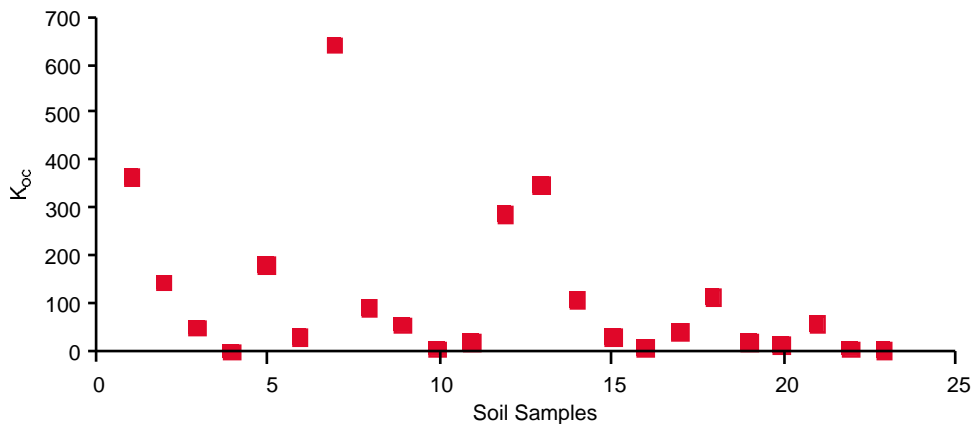

Figure 3. Variations in K_{oc} for atrazine in various soils (soil sample numbers correspond to those in Table 1).

Table 4. Sorption for various pesticides.

Pesticide	Sorption (K_{oc})			
	Mean \pm SD	Median	Range	Overseas Mean
atrazine	114 \pm 160	49	0–645	100
DEA	73 \pm 98	39	3–415	–
DIA	60 \pm 79	35	5–338	–
fenamiphos	495 \pm 492	271	0–1403	100
FS	53 \pm 86	14	0–341	–
FSO	79 \pm 129	25	0–542	–
fenarimol	905 \pm 669	749	6–1744	600
azinphos methyl	655 \pm 912	175	0–2463	1000
prometryn	1154 \pm 706	1541	0–1724	400

Notes: $K_{oc} = 100 \times K_d / \text{OC}\%$; SD = standard deviation

Overseas data are from Wauchope et al. 1992

'Overseas mean' K_{oc} for fenamiphos is weighted for sulfoxide as major residue.

pesticides. For example, the soils with OC of 2.5–3 per cent showed a K_d for fenamiphos of 10–40 L/kg. The correlation coefficient did not improve when the data from the surface soil only were plotted (results not shown). The relationship was, however, better for the metabolites than the parent compounds for both atrazine and fenamiphos. For example, while only 48 per cent of variation in the K_d for atrazine was explainable on the basis of organic carbon content of the soil, for DEA it was 69 per cent. The reason for a better correlation for the metabolites is likely to be due to the smaller magnitude of sorption of the metabolites resulting in a smaller scatter.

The poor correlation between K_d and OC is not surprising because not only can other factors, such as pH and clay content, affect the K_d , but also the type of organic matter (in terms of its aromaticity and stage of decomposition) is an important determinant of pesticide sorption (Ahmad et al. 2001). The nature of organic matter in surface soils and subsoils, as well as in soils under different landuses, is likely to be quite different.

A comparison of sorption data with that reported from overseas

The K_d and organic carbon values from Table 3 were used to derive sorption (K_{oc}) for each pesticide in each soil. K_{oc} values for each pesticide are compared with overseas data in Table 4.

If organic matter was the sole sorbent and the OC in all soils had the same sorption capacity per unit mass for each pesticide, then a narrow range of K_{oc} would be expected. However, it is clear from the table that K_{oc} ranged widely between soils, as is evident from the high standard deviations. For example while K_{oc} values for atrazine varied between soils by nearly three orders of magnitude, most of the K_{oc} data fell between 10–100. This pattern is shown in Figure 3. The pattern for other pesticides was similar.

Prometryn stood out as the pesticide with a much higher mean and median K_{oc} value than those reported in the overseas database (Table 4). This may have been caused by the acidic nature of several soils used in the study. Prometryn, being a weak base with a pKa of 4.05 (see Table 2), would be affected substantially by pH in these soils. The huge variation in K_{oc} values for various pesticides suggests that average K_{oc} values available in overseas databases for site-specific assessments of pesticide sorption are inadequate, especially for subsurface soils.

Conclusions

A study was conducted to estimate the sorption of nine different pesticides in 23 soils of the Swan Coastal Plain surface (0–15 cm) and subsurface

(40–50 cm) soils were collected from several sites under native vegetation (Banksia woodland) and market gardens. Sorption was measured by a batch equilibration method for several pesticides, namely atrazine and its two metabolites (desethylatrazine and desisopropylatrazine), fenamiphos and its two oxidation analogues (sulfoxide and sulfone), prometryn, azinphos methyl and fenarimol.

Sorption per unit mass of organic carbon in soils (K_{oc}) showed a wide variation among the soils studied, possibly reflecting the varying nature of organic materials present in the soils. Organic carbon content alone could not explain the differences in pesticide sorption among soils. The sorption figures were much lower in the subsoils, which suggests that in such soils, once the pesticide leaches beyond 50 cm depth, it can essentially move with the water-front with little retardation due to sorption. The metabolites of atrazine and fenamiphos had much lower sorption affinities for soils than their respective parent compounds. The metabolites of fenamiphos had up to an order-of-magnitude lower sorption than the parent compound in some soils. Given that these metabolites are equally toxic in nature and more persistent than the parent compound, the groundwater pollution potential of these metabolites needs adequate consideration.

References

- Ahmad, R., Kookana R.S., Alston, A.M. and Skjemstad, J.O. 2001. The nature of soil organic matter affects sorption of pesticides. I. Relationship with carbon chemistry as determined by ¹³C NMR spectroscopy. *Environmental Science and Technology* 35: 878–884.
- Bauld, J. 1996. Groundwater quality: human impact on a hidden resource. *Proceedings of 23rd Hydrology and Water Resources Symposium*, Hobart, 21–24 May: 143–147.
- Kookana, R.S., Baskaran, S. and Naidu, R. 1998. Pesticide fate and behaviour in Australian soils in relation to contamination and management of soil and water — a review. *Australian Journal of Soil Research* 36: 715–764.
- Kookana, R.S., Phang, C. and Aylmore, L.A.G. 1997. Transformation and degradation of fenamiphos nematocide and its metabolites in soils. *Australian Journal of Soil Research* 35: 753–761.
- Lee, C. C., Green, R. and Apt, W. J. 1986. Transformation and adsorption of Fenamiphos, F. sulfoxide and F. sulfone in Molokai soil and simulated movement with irrigation. *Journal of Contaminant Hydrology* 1: 211–225.
- Vighi, M. and Funari, E., eds., 1995. *Pesticide risk in groundwater*. CRC Lewis Publishers, London.
- Wauchope, R. D., Buttler, T. M., Hornsby, A. G., Augustijn-Beckers, P. M. W. and Burt, J. P. 1992. The SCS/ARS/CES pesticide properties database for environmental decision-making. *Reviews of Environmental Contamination and Toxicology* 123: 1–164.

Nutrient and Pesticide Leaching in Experimental Sites in the Swan Coastal Plain

R.B. Salama, J.D. Byrne and D.W. Pollock¹

Abstract

Different methods were used to sample soil water and groundwater from the unsaturated and saturated zones of two experimental sites in the Gngangara Mound. The results show that suction cups give more representative samples at the selected depth and time, while lysimeters give an integrated sample over a longer period. The results from the suction cups at various depths were in accordance with anticipated natural attenuation, and with the concentrations in groundwater. On the other hand, the results from the lysimeters were lower and did not reflect the higher fluxes encountered in the groundwater samples. Traces of the tested pesticides (atrazine, diazinon, dimethoate, endosulfan, fenamiphos, iprodione, malathion and chlorpyrifos) were detected in soil samples in two experimental farms in the Gngangara Mound. However none of the pesticides was detected in the groundwater samples collected by the different techniques from depths ranging from 30 cm to 2.0m. Due to excessive application of nutrients and the shallow groundwater depth, NH_4 and NO_3 were leaching to the groundwater at high rates. Initial N levels were high and rapidly decreased by depth and by distance away from the agricultural areas. The results also show that the leaching process can be greatly reduced by reducing irrigation and applying the recommended fertiliser rates.

SEVERAL METHODS for assessment of soil-water quality were experimented with in two sites in the Gngangara Mound to monitor the movement of nutrients and pesticides through soils to the unconfined aquifers. The porous ceramic suction cup and the free-draining lysimeter, as well as gravimetric soil sampling, were used in the unsaturated zone. Multi-level samplers and piezometers were used in the saturated zone. The main objectives of this study were to:

- compare the different sampling methods and assess their suitability by comparing the results of pesticides and inorganic pollutants such as $\text{NO}_3\text{-N}$, $\text{PO}_4\text{-P}$, $\text{NH}_4\text{-N}$, and pH
- monitor nutrient and pesticide leaching using different sampling techniques
- utilise the data to calibrate and validate applied models (Salama, Pollock and Byrne 2001).

Location and Methods

Two experimental sites were chosen, a strawberry farm and a turf farm. The sites were located on the Swan Coastal Plain on Bassendean Dune System

sands series (Figure 1). The Bassendean Dune System sands were formed of aeolian and fluvial depositional material with the sand grains being well sorted and rounded. The two sites are located on the Gavin and Joel sands where groundwater is within two metres of the soil surface, and the subsoil has a cemented iron-humus podsol associated with the watertable. The average bulk density of these sands is 1.5 gm/cm^3 with a greater than 98 per cent sand fraction within virgin soil.

Lysimeters, ceramic suction cups, multi-level soil-water sampling piezometers, and groundwater-sampling tubes were installed. They were sampled seven times between 19 September and 17 November 1997.

A water meter, similar to Water Corporation meters used for domestic homes, was installed in irrigation lines before the sprinklers and used to record water applied to the area surrounding the lysimeters. The irrigation sprinkler was either a *Rainbird* or a *Hunter* irrigation sprinkler with a throw

¹ CSIRO Land and Water, Private Bag No 5, PO Wembley, Western Australia 6913

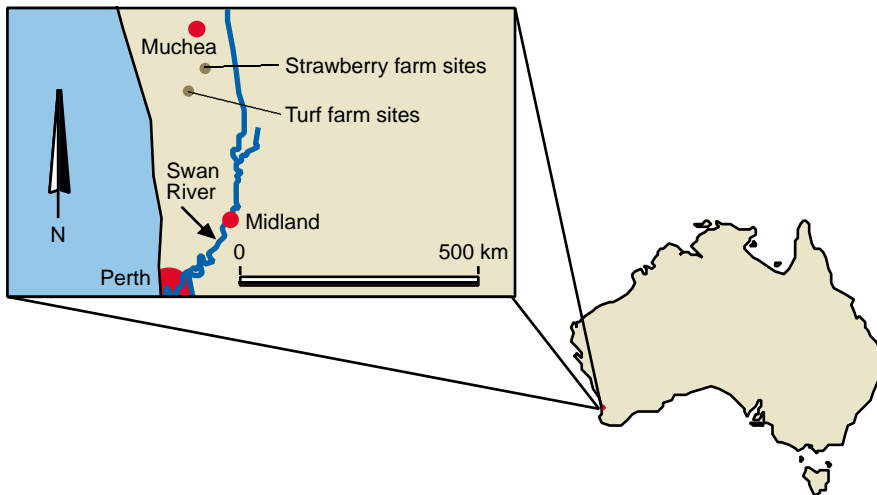

Figure 1. Location of experimental sites.

of 18 m. Rain events and amounts were recorded by a 0.2 mm tipping-bucket rain gauge which was installed approximately 100 m south-west of the lysimeters in an open area out of the influence of irrigation sprinklers.

Soil was sampled with an alloy tube, 47 mm ID x 50 mm OD x 300 mm, using a piece of wood and a hammer to gently tap the alloy tube with the sharpened end down into the soil to its full length. The sample tube was sealed at both ends with aluminum foil and the ends were taped airtight. The sample was placed into a car freezer and transported to the laboratory. At the strawberry farm the soil was sampled from the immediate surface. No soil was removed prior to sampling. At the turf farm, turf was removed to a depth of 30 mm removing both the turf itself and immediate dense root material associated with this level. The soil was sampled from this level down to 300 mm using a single-length alloy tube.

Strawberry farm

During the experiment, the Chandler variety of strawberries was planted in the farm. It is a short-day variety planted in winter. The crop was planted in the first week of June 1997. The seedlings were planted on metre-wide mounded soil beds in two rows 30–50 cm apart with plants staggered 30–40 cm apart. The average plant produces 0.75–1.0 kg per season. The picking season starts at the end of August or beginning of September. Picking takes place every second day and continues to the end of November when the crop is abandoned and spray-killed to avoid spread of fungal diseases.

The site of the experiment had been fallow for 18 months. The farmer had pre-treated the soil with raw chicken manure and mounded the bed area ready for

installation of plastic sheeting and crop planting. The crop was planted under plastic sheeting covering the metre-wide strawberry beds. This technique made it possible to measure soil water concentrations of applied chemicals from fertigation lines and pesticides applied by overhead spray from a tractor under two different conditions: under plastic; and uncovered areas.

Six small surface-area free-drainage lysimeters were installed in positions that ensured that both plants and water fertigation lines were directly above the instruments. Lysimeters and ceramic suction cups (Figure 2) were also installed under the interbed area between the strawberry beds (Figures 3–4). The interbeds are 40 cm wide and subject to overhead sprinkler, precipitation plus spray applications. This enabled sampling of soil chemicals and pesticides without the effect of plants.

Each lysimeter was installed in a 70 cm square hole. The top 30 cm of organic topsoil was set aside and placed back into position after lysimeter installation. All soil was removed to a depth of 1.2 m and stockpiled on plastic sheeting. Once the lysimeters were installed, the soil was replaced and compacted to near field density. Of the six lysimeters, five were of the same design (Figure 5): 70 cm tall x 40 cm square with a leachate collection chamber. They also had a floor sloping towards the extraction outlet of the lysimeter. This allowed the extraction of all the leachate within the chamber. The sixth lysimeter was 30 cm shorter and had no sloping floor. The leachate was extracted via individual semi-rigid nylon tubes inserted into the lysimeters' collection chambers. Inside the lysimeters, soil leachate was filtered

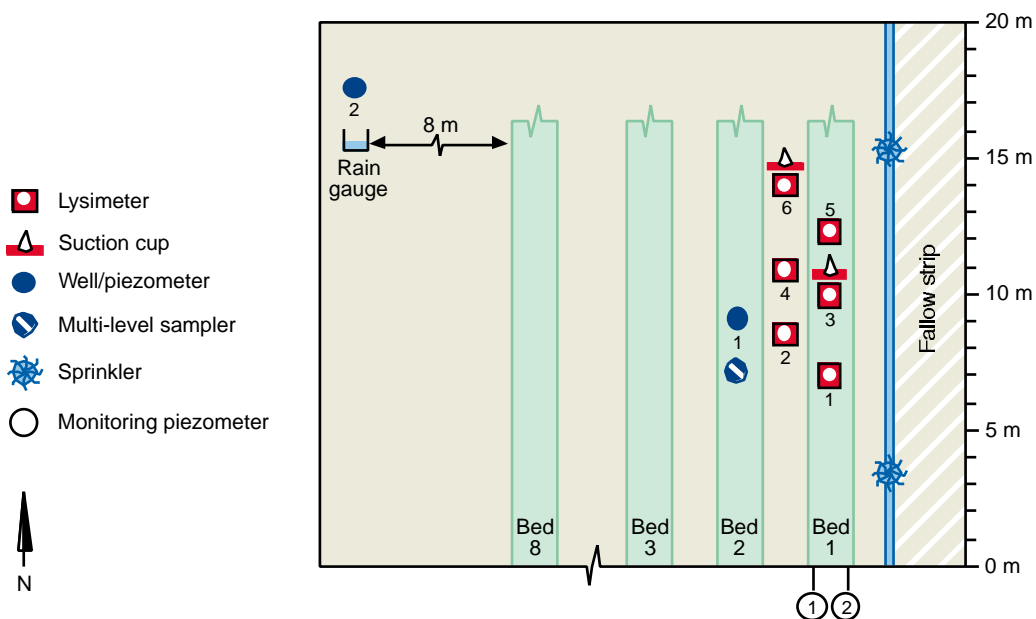

Figure 2. Instrumentation setup at the strawberry farm.

through a 45–90 μm nylon felt fabric material. The material was supported on a galvanised iron grid-mesh floor. Sampling of soil leachate from the lysimeter was achieved by a vacuum pump attached to a pyrex glass vacuum flask connected via a semi-rigid nylon tube from the lysimeter and teflon and stainless steel tubing to minimise contamination and loss of any chemicals or sorption of pesticides.

Two sets of three ceramic suction cups were installed at two locations, one set under each strawberry bed and interbed. The first suction cup was installed at 30 cm depth between the topsoil and subsoil (Figure 4). The second and third cups were placed at depths of 50 cm and 70 cm. The difference in levels between the interbeds and beds resulted in the first suction cup (30 cm) in the interbed being only 15 cm below the ground surface. The travel time for nutrients to this set of suction cups could be shorter, depending on difference in water application rates. The suction cups were evacuated and sampled via 60 ml syringes attached to each individual suction cup. The tubing on each suction cup was a hard nylon tube which did not sorb pesticides.

A set of multi-level groundwater sampling tubes ('sippers') was installed in the middle of the bed next to the lysimeters. The depths of installation were 0.6, 0.8, 1.0, 1.2, 1.4, 1.6, 1.8 and 2.0 m from ground-level. The samples were obtained by suction using individual syringes for each sampling depth.

Two piezometers were installed in the site, one in the crop area and the other west of the strawberry crop bed. They were installed to a depth of 2.5 and 3 m respectively using 50 mm diameter slotted aluminium pipe. Data loggers and water-level probes were installed in the piezometers to monitor water-level changes.

Water application was by 2 m overhead sprinklers, 15 mm slotted irrigation lines and by rainfall. The slotted irrigation lines were installed on each side of the crop bed on each side of the strawberry plants under black plastic sheeting. The plastic covered the whole width and length of the crop bed. The plastic was used to reduce soil moisture evaporation and to maintain an even soil moisture content and soil temperature.

Rain events were recorded by a 0.2 mm tipping bucket rain gauge installed west of the strawberry beds in an open area out of the influence of irrigation sprinklers (Figure 2). The rainfall pattern is shown in Figure 6.

Turf farm

Three lysimeters were placed under Wintergreen Turf (Figure 7). The lysimeters were 60 cm tall and 40 cm square with a 15 cm deep collection chamber in the base including a sloped floor for better drainage. Three were installed in a line starting two metres in from a limestone road; the other two were equally spaced with two metres centre-to-centre between all

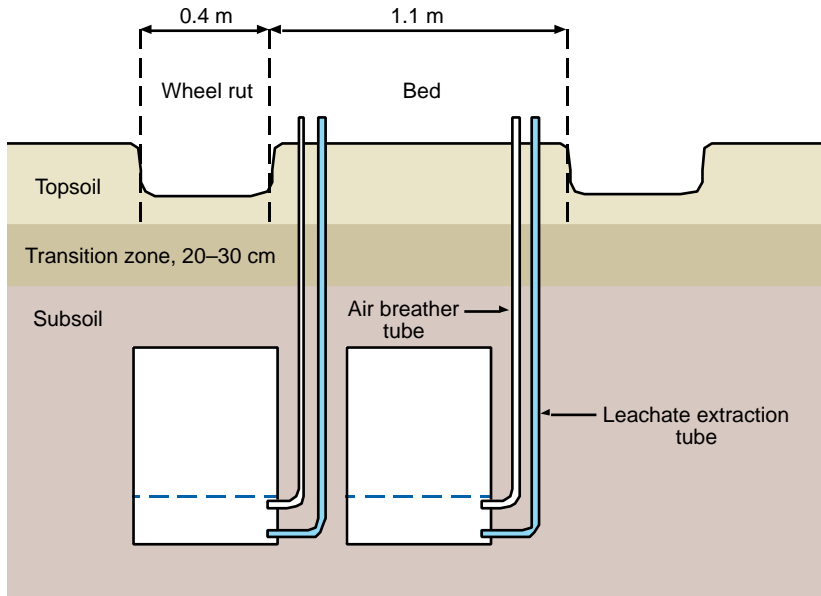

Figure 3. Lysimeter installation (strawberry farm).

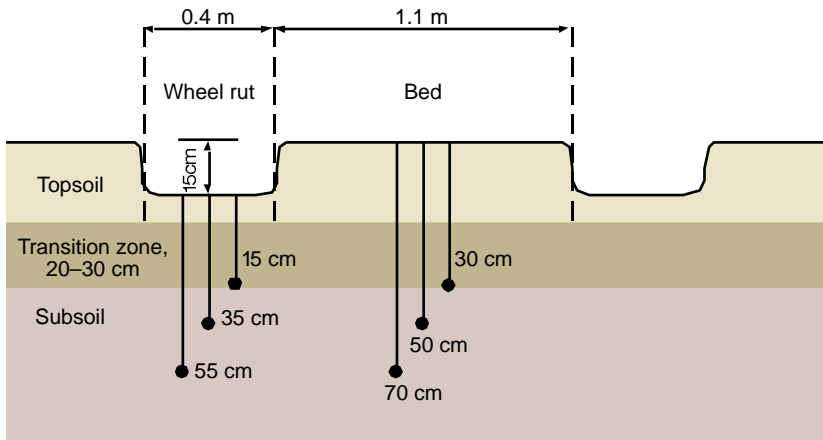

Figure 4. Suction cup installation (strawberry farm).

lysimeters (Figure 8). The turf was removed and placed to one side and then the soil from each hole removed in 20 cm intervals and piled on plastic sheeting nearby. The lysimeters were then installed and the soil layers returned in sequence. The soil was compacted back at each level to as close as to field bulk density as could be achieved. The turf was then placed back and hand compacted back to the sur-

rounding surface level. The leachate dripped into the collection chamber and samples were taken via a vacuum pump connected to a glass volumetric flask. Each lysimeter had a separate glass flask to prevent contamination.

Suction cups were installed in the lysimeter holes before the installation of the lysimeters. Each of the three holes had a set of three suction cups installed in

Results and Discussion

Infiltration and water balance

The results of a long-term study in 1998 in the strawberry farm showed that infiltration in winter and summer were 421 and 189 mm respectively. The total recharge was 44 per cent of the total water input during this period, which included 558 mm of rain. Due to the shallow depth to groundwater, it was assumed that all the water infiltrating past the lysimeter would reach the groundwater as recharge.

In short-term studies infiltration was measured for selected periods in late 1997 (Table 1). In the turf farm (between August and November) that infiltration was about 62 per cent of total water input. By contrast, in the strawberry farm (between July and November) infiltration was only 26 per cent.

Water-level fluctuations in the strawberry farm piezometer showed two distinct patterns during the recession period from September to November (Figure 9). The first pattern occurred when no irrigation was applied; the recession fell smoothly without daily fluctuations. The second pattern was noticed when irrigation started, with the water-level showing rises of 2–5 cm whenever irrigation was applied. This was clear evidence that most of the irrigation water reaches the watertable at the rate of 6–15 mm per irrigation; Specific Yield (S_y) = 0.3.

Pesticides

Although some traces of the tested pesticides (atrazine, diazinon, dimethoate, endosulfan, fenamaphos, iprodione, malathion and chlorpyrifos) were detected in soil samples in two experimental farms in the Gngangara Mound, none of the pesticides was detected in the groundwater samples collected by the different techniques from depths ranging from 30 cm to 2.0 m (Table 2).

Nutrients

In the turf farm (Figure 10), nitrate-N concentrations in leachate increased with time and depth in the suction cups (10–350 mg/L). In the groundwater samplers the concentrations increased with time and (slightly) with depth (2–60 mg/L). In the lysimeters, concentrations increased with time (10–100 mg/L). Ammonium concentrations decreased with depth and increased with time in all sampling points. The level of phosphate was high near the surface sampling points (10–95 mg/L), but decreased with depth below 0.75 m and remained constant at 2.0 m.

In the strawberry farm, the results from the suction cups below the beds (Figure 11) showed that the concentrations of nitrate decreased with depth but

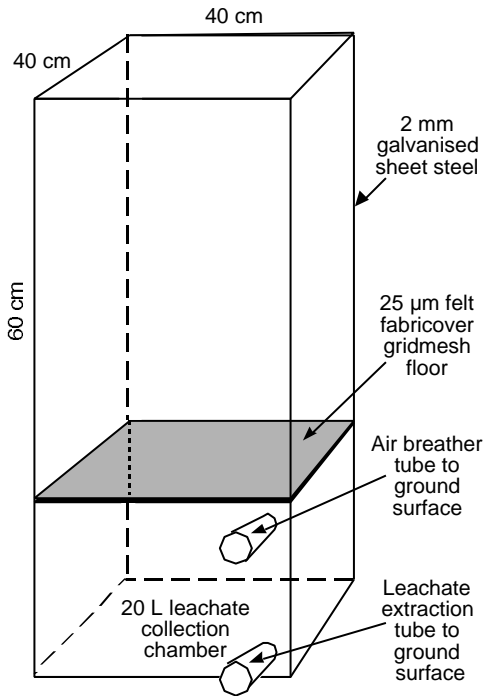

Figure 5. Typical lysimeter design used at both farms.

holes bored 40 cm horizontally into the soil. Each suction cup was installed into the hole using a fine grade silicon slurry to ensure contact with the surrounding soil. Depths of each set of suction cup were 30 cm, 60 cm and 90 cm respectively. The suction cups were 60 mm in length and 48 mm in diameter, being slightly larger in surface area than those used at the strawberry farm. The suction cups were evacuated and sampled via 60 ml syringes attached to each individual suction cup. The tubing on each suction cup was a semi rigid hard nylon tube, which did not sorb pesticides.

Multi-level groundwater sampling points were installed 4 m north of the middle lysimeter. The depths of installation were 1.4, 1.6, 1.8, 2.0 and 2.2 m from ground-level.

Two piezometers were installed (Figure 8), the first one near the limestone road in the 40 cm verge of the turf grass area; the other was installed 12 m east of the boundary of the turf farm in the banksia bushland and east of the lysimeters. They were installed at a depth of 3 m using 50 mm diameter slotted aluminium pipe. A third piezometer installed by Agriculture Western Australia was used for the recording of groundwater level fluctuations using a data logger and water-level probe.

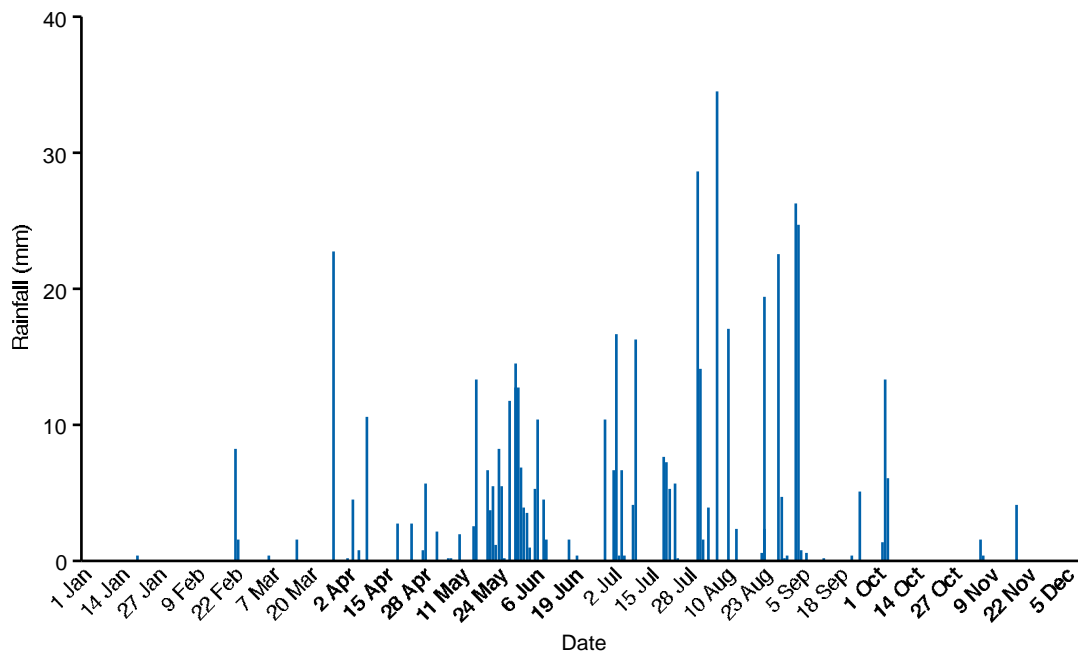

Figure 6. Daily rainfall from Pearce Weather Station, Bulls Brook, near both farms (1997).

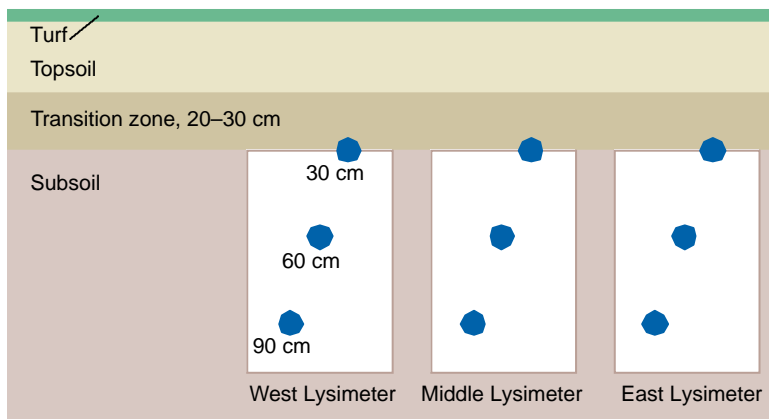

Figure 7. Location of lysimeters and suction cups (turf farm).

Table 1. Water balance of strawberry and turf farms.

Inputs (mm)			Outputs (mm)			Ratios			
R	P	I	IT	Et	Ep	R/IT	I/IT	IT/Ep	Et/Ep
<i>Strawberry farm</i> (18/08/97–17/11/97)									
226.00	430.60	426.00	856.60	630.60	423.20	0.26	0.50	2.02	1.49
<i>Turf farm</i> (23/07/97–25/11/97)									
153.60	134.00	115.58	249.58	95.98	324.50	0.62	0.46	0.77	0.30

Notes: R = Recharge, P= Precipitation, I = Irrigation, IT = Total water input (including recharge), Et = Estimated evapotranspiration, Ep = 'Class A' pan evaporation.

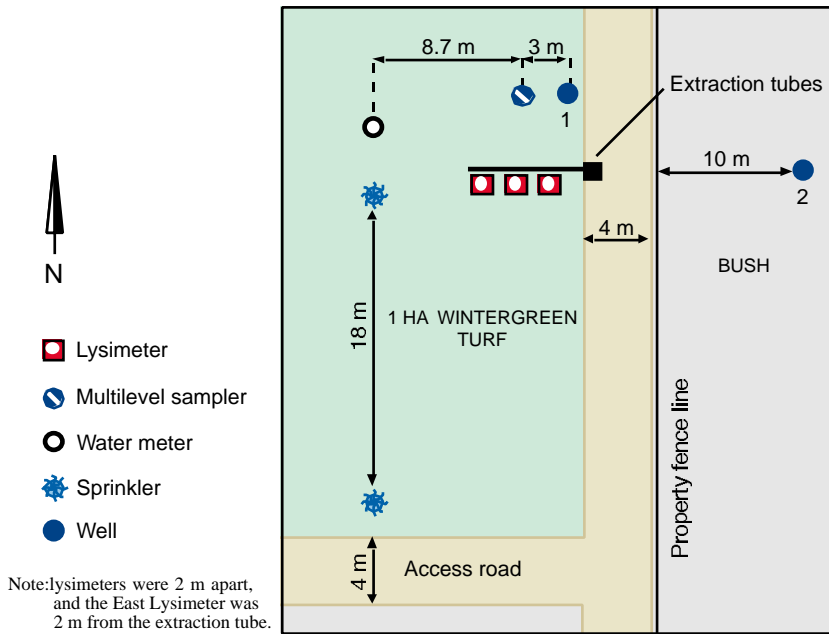

Figure 8. Location of lysimeters and other instrumentation (turf farm).

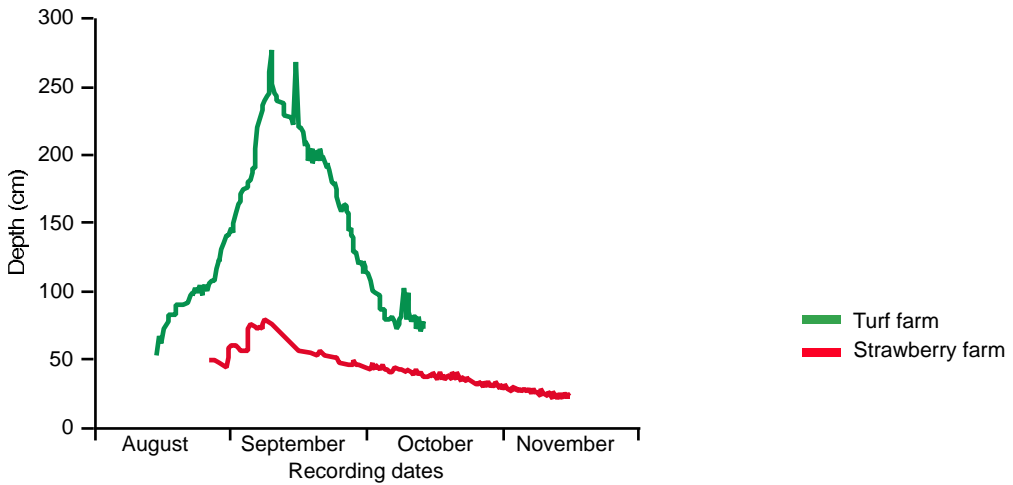

Figure 9. Water-level fluctuations.

Table 2. Pesticide analysis.

Depth of Sample (cm)	Pesticide ($\mu\text{g}/\text{kg}$)						
	Atrazine	Diazinon	Dimethoate	Endosulfan	Chlorpyrifos	Fenamiphos	Malathion
<i>Strawberry farm (18/09/97)</i>							
0–10	<1	<5	<10	<10	<5	<5	<5
10–20	<1	<5	<10	<10	<5	<5	<5
20–30	<1	<5	<10	<10	<5	<5	<5
<i>Turf farm (14/10/97)</i>							
0–10	<1	<5	<10	<10	<5	<5	<5
10–20	<1	<5	<10	<10	<5	<5	<5
20–30	<1	<5	<10	<10	<5	<5	<5

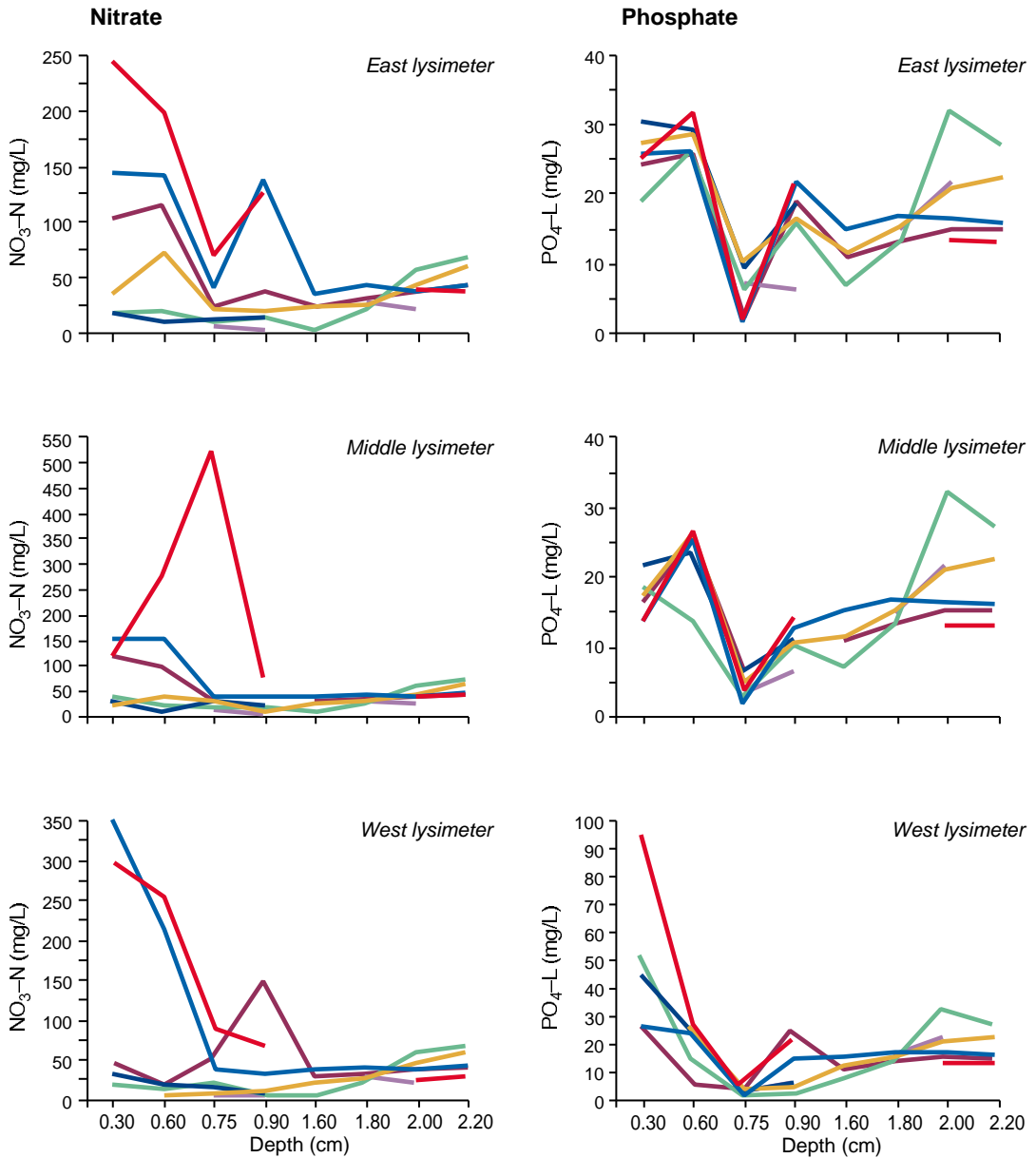
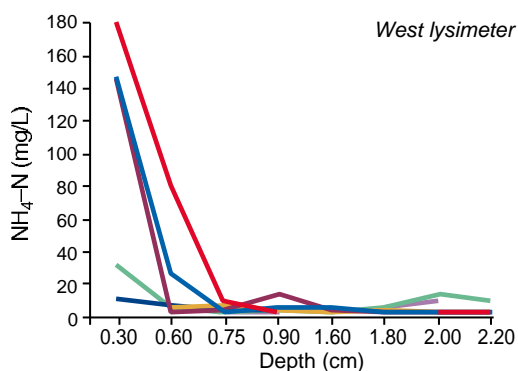
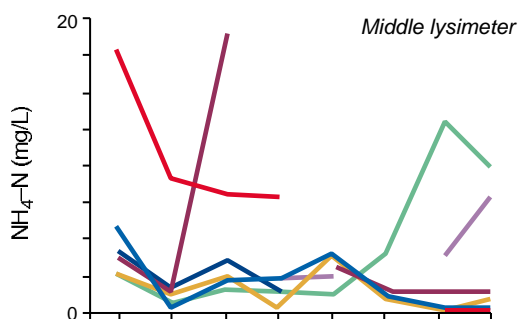
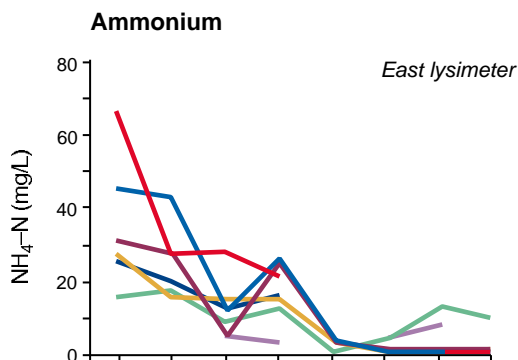

Figure 10. Distribution of NO₃, PO₄ and NH₄ in the beds at the turf farm.

Table 3. Nutrient balances for strawberry and turf farms (lysimeter data).

Inputs			Flow-weighted Concentration (mg/L)						Outputs				
Fertiliser (kg/ha)			NO ₃ -N			NH ₄ -N			Yield (kg/ha)				
Total N	PO ₄ -P	Cl	NO ₃ -N	NH ₄ -N	Total N	PO ₄ -P	Cl	NO ₃ -N	NH ₄ -N	Total N	PO ₄ -P	Cl	
<i>Strawberry farm (28/05/97-25/11/97)</i>													
384.80	46.80	0.00	34.62	3.22	37.84	6.74	29.73	61.02	5.67	66.69	11.88	52.41	
<i>Turf farm (18/08/97-17/11/97)</i>													
282.30	85.20	0.00	49.56	5.39	54.95	4.32	119.07	84.44	9.19	93.64	7.37	202.88	



Legend for Figures 10–12.

- 12/9/97
- 19/9/97
- 25/9/97
- 13/10/97
- 21/10/97
- 3/11/97
- 17/11/97

increased with time. In the groundwater samplers, nitrate decreased with depth and increased with time; in the lysimeters, concentrations slightly increased with time.

In the interbeds (Figure 12), nitrate systematically increased with both depth and time in the suction cups; in the groundwater samplers, concentration decreased with depth and slightly increased with time. There was no change in the lysimeter readings.

In both the beds and the interbeds, phosphate decreased with depth and slightly increased with time in the suction cups, decreased with depth and slightly decreased with time in the groundwater samplers, and did not change in the lysimeters. Ammonium concentrations decreased with depth and increased with time at all sampling points.

The overall results showed that due to the excessive application of nutrients, NH_4 and NO_3 leached to the groundwater at high rates. Nitrogen levels (15–54 mg/L) were above the acceptable limits in the top 1.6 m of the shallow aquifer system; this trend decreased abruptly below 2.0 m where the concentrations were 1.0 mg/L or less. Phosphorus increased with time, and decreased with depth; concentrations were 4–10 mg/L above 1.6 m and decreased to 2–4 mg/L below that depth. Ammonium concentrations ranged from <1.0 to 4 mg/L in the top 60 cm.

Leachate concentration

In the turf farm the nitrate increased with time and increased substantially when more fertiliser was applied. The concentration in the suction cups decreased regularly with depth, but the results from the lysimeters that were installed at 0.75 m were always lower than the results from the suction cup which was installed at 0.9 m. This was mainly due to variations in the disturbance caused by the installation techniques, sample size, extent of temporal integration, and to a minor degree the spatial variability (Ahmed, Sharma and Richards 1996). Concentrations continued to decrease with depth to the surface of the groundwater, and thereafter it began to increase slightly in the groundwater below 2.0 m.

Although Ahmed et al. concluded that lysimeters gave more reliable results than suction cups, results from this experiment showed that for detailed studies of water and solute movement in the unsaturated zone, the suction cups gave more reliable results than the modelling results (Salama, Pollock and Byrne 1999). However, a comparison of results among suction cups, groundwater samplers and lysimeters shows that the nitrate concentrations in samples from

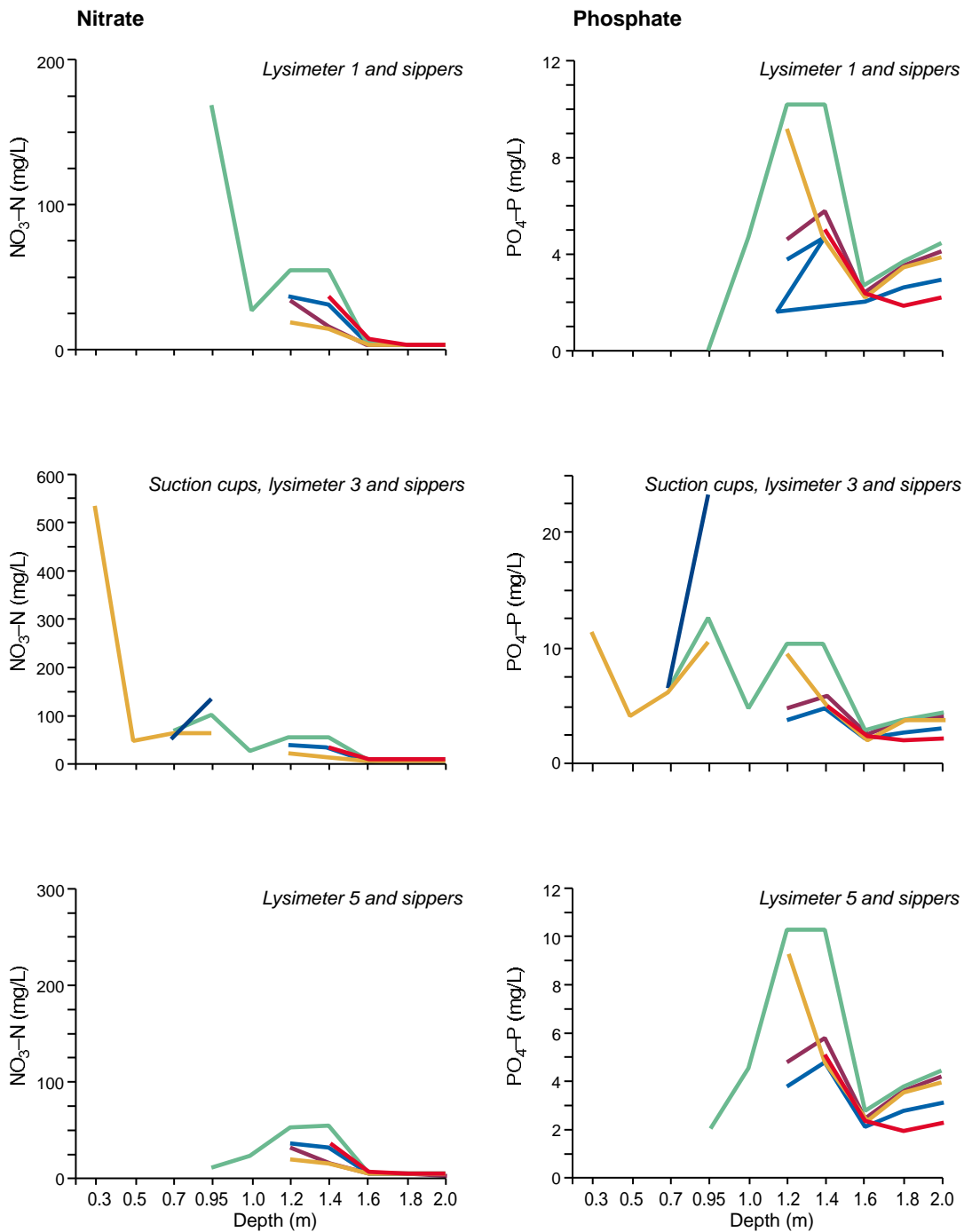
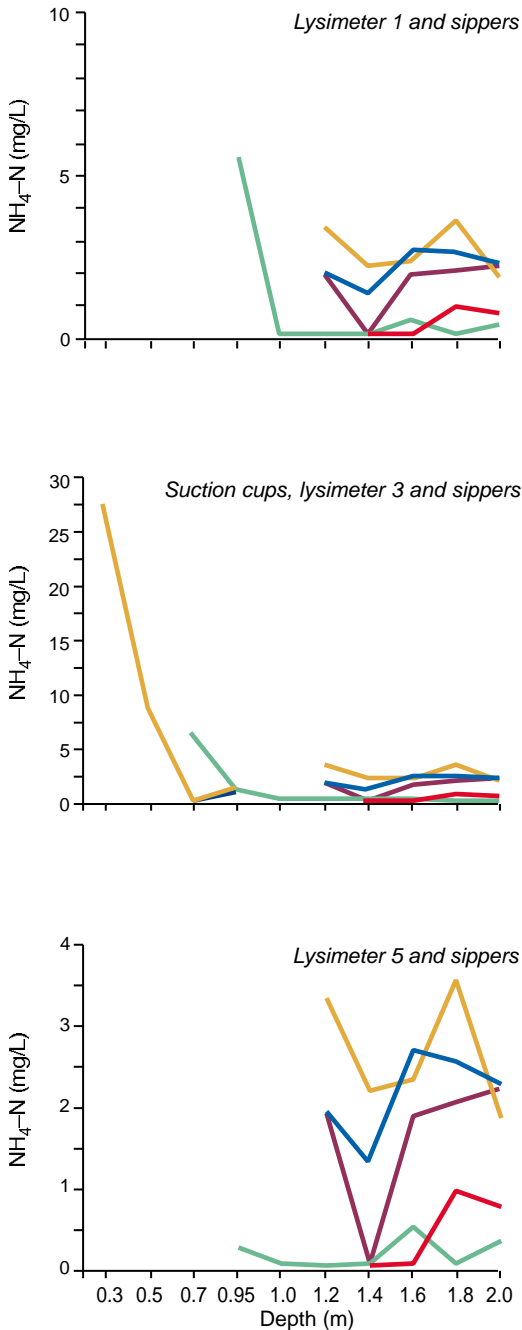

Figure 11. Distribution of NO₃, PO₄ and NH₄ in the beds at the strawberry farm.

Ammonium



the lysimeter were in most cases lower than those in the groundwater, and did not match the gradual decrease in concentration with depth from surface to groundwater.

The phosphate results were in general similar to those of the nitrate, although much lower in concentration. The concentrations in the lysimeter were very low compared with the other results from the suction cups and groundwater. It is possible that the higher degree of disturbance in the construction of the lysimeters and the compaction applied to the top organic layer may have caused more fixation of the P than the other methods. The P also increased slightly in groundwater by depth. Ammonium on the other hand decreased regularly with depth including the lysimeter. The results from the three different sets of samplers showed the variation in application rates of fertilisers, irrigation water, plant uptake and spatial variability in soil hydraulic properties.

Although the results from the strawberry farm followed the same trend as those of the turf farm, the results for nitrate from the samples under the strawberry beds are higher than the interbeds as most of the nutrients were supplied through the fertigation lines. There were no discernible patterns for NH_4 and P.

Nutrient leaching and balances

Fertiliser application rates are shown in Table 3. During the short-term monitoring in the strawberry farm, 384 kg/ha of N and 47 kg/ha of P were applied, the lysimeter outputs were 67 kg/ha of N and 12 kg/ha of P. This indicated that 82 per cent of the N and 25 per cent of the P were either used by the plants, volatilised or retained in the topsoil. It also indicated that the remaining portion of the nutrients would reach the groundwater.

During the long-term monitoring in the strawberry farm smaller amounts of nutrients were applied and the results showed that 36 per cent of the N and 26 per cent of the P passed the root zone. In the turf farm, the results showed that 33 per cent of N and 8 per cent of P passed through the root zone.

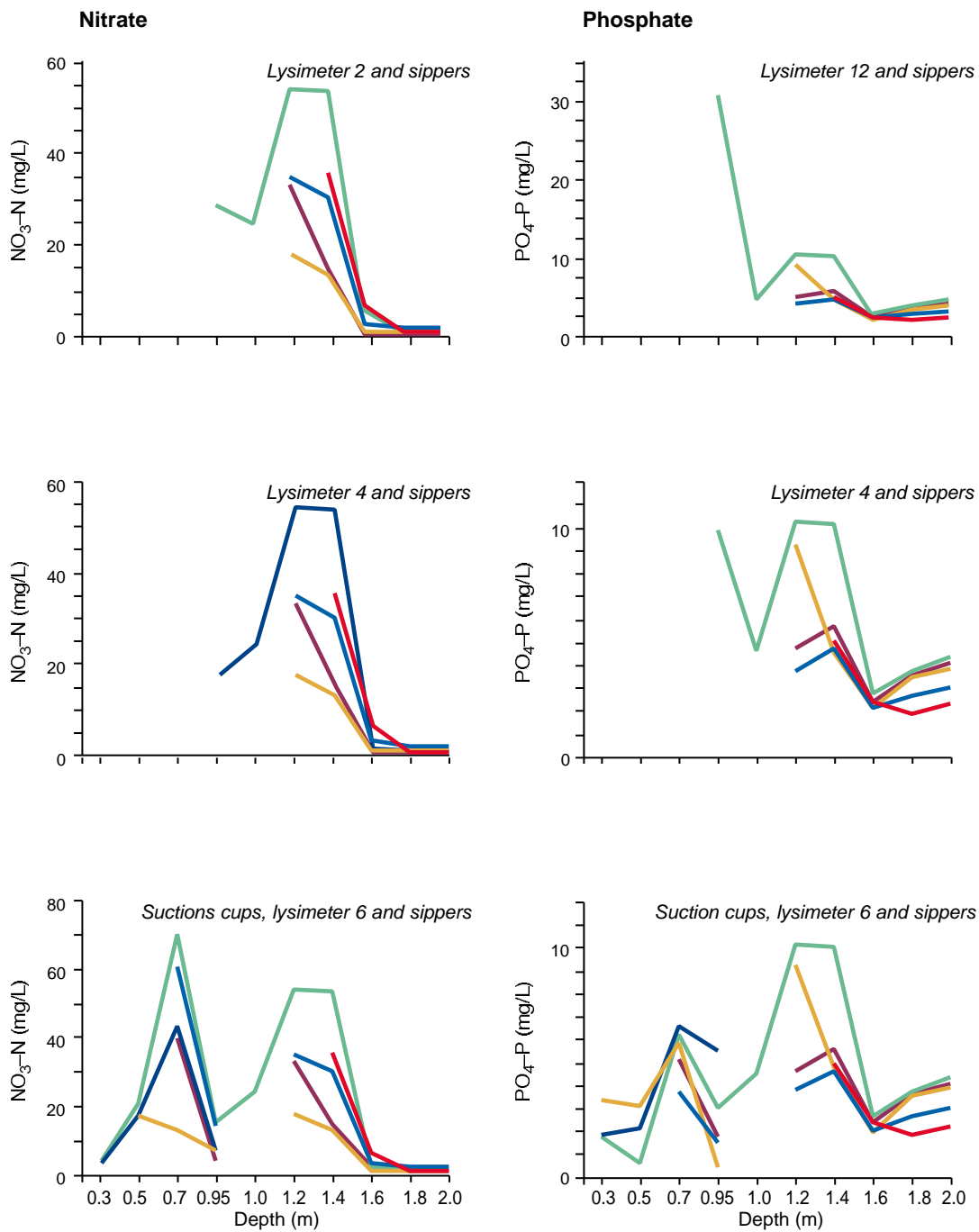
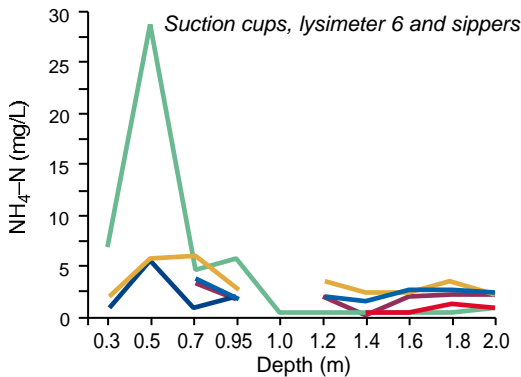
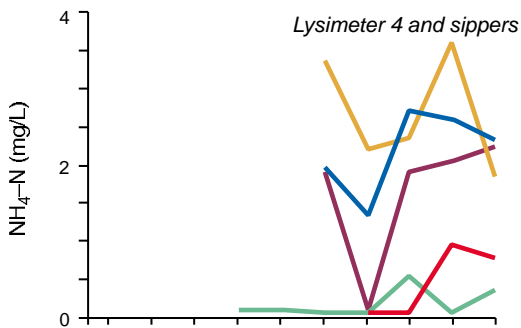
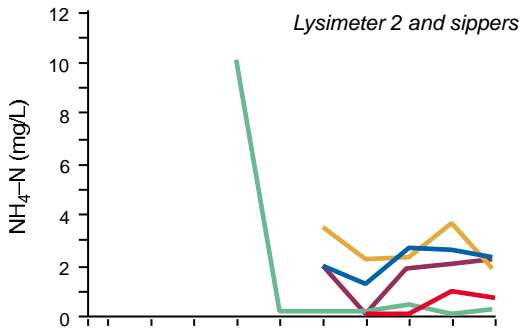

Figure 12. Distribution of NO₃, PO₄ and NH₄ in the interbeds at the strawberry farm.

Ammonium



Conclusions

Different methods were used to sample soil water and groundwater from the unsaturated and saturated zones of two experimental sites in the Gngagara Mound. The results show that most of the irrigation water reaches the watertable at the rate of 6–15 mm. Total recharge from irrigation ranged from 26 to 62 per cent of irrigation water. Ammonium and nitrate concentrations in the leachate increased with time and depth, phosphate was relatively high near the surface and decreased with depth, and pesticides were filtered in the top 1–5 cm. The results also show that the amount of nutrients leaching to the aquifer depends on application rates. Even when smaller amounts of nutrient were applied, 36 per cent of the N and 26 per cent of the P passed the root zone in the strawberry farm; in the turf farm, the corresponding figures were 33 and 8 per cent.

References

- Ahmed, M., Sharma, M.L. and Richards, Q.D. 1996. Evaluation of field sampling methods for soil water quality. *In*: Aminuddin, B.Y., Sharma, M.L., and Willett, I.R., eds., Agricultural impacts on groundwater quality. Proceedings of an international workshop held in Kota Bharu, Kelantan, Malaysia, 24–27 October. ACIAR Proceedings No 61, 64–70.
- Salama, R.B., Pollock, D. and Byrne, J. 1999. Experimental and modelling results of pesticide leaching in agricultural systems: Examples from Thailand, Malaysia and Australia. Solutions and Innovations. Proceedings of International Conference on Diffuse Pollution, Perth, Western Australia, 16–20 May.
- Salama, R.B., Pollock, D. and Byrne, J. 2001. Modelling pesticide and nutrient transport in the Gngagara Mound. These Proceedings.

Modelling Pesticide and Nutrient Transport in the Gnangara Mound

R.B. Salama, D.W. Pollock and J.D. Byrne¹

Abstract

The major agricultural activity in the Gnangara Mound area is intensive horticulture, predominantly for vegetables, native and greenhouse flowers, citrus, avocados, stone fruit, grapevines, turf and nursery crops. These industries depend heavily on pesticides and nutrients for the production and protection of their produce. The excessive use of such agrochemicals is threatening the groundwater resources of the Mound. A detailed field study was conducted of the filtration capacity of the main soil-types of the Spearwood and Bassendean Sands on which most of these activities are taking place. Two experimental sites were established in agricultural areas to monitor nutrients and pesticides in groundwater under agricultural areas. The monitoring was conducted using different techniques (lysimeters, suction cups, multi-level samplers, and shallow groundwater piezometers). None of the tested pesticides were detected in the groundwater samples collected by the different techniques from depths ranging from 30 cm to 2.0 m. These results were similar to the modelling results which showed that most of the pesticides are highly sorbed to the organically-rich soils and are therefore not leached below the top 10 cm layer. Some pesticides leach very quickly below one metre, but due to their short half-life they also degrade quickly and the amount remaining in the soil after the first week of application is very small. Atrazine, on the other hand, has higher sorption, but it persists for a long time in the soil due to its long half-life; in most cases, small amounts are leached to groundwater. A Microsoft Access database has been established for the different pesticides, soils and water properties. Hornsby Index (HI) and Attenuation Factor (AF) models were used to screen the suite of pesticides used. The pesticides with high leaching potential were modelled using CMLS and LEACHP to monitor their movement in the unsaturated zone. LEACHN was used to monitor the movement of nutrients in the unsaturated zone and to model the effect of applying different scenarios to reduce the leaching of nitrates.

THE GNANGARA MOUND is the largest groundwater body in Perth, and the superficial aquifer is the most important in the Mound. It is a complex, unconfined, multi-layered aquifer. The sediments which constitute the superficial aquifer range from predominantly clayey in the east, through a sandy succession (Bassendean Sand and Spearwood Sand) in the central coastal plain area, to sand and limestone (Tamala limestone) in the coastal belt (Davidson 1995). The geological formations provide the main basis for dividing the soil-mapping units into three dune systems: Bassendean, Spearwood and Quindalup. These are characterised by distinctive geomorphology and soils that are different from the alluvial landscapes to the east and north. The Bassendean Dunes generally have low relief and minor variations in topography

with variable depth to the watertable. The landscape comprises permanent open-water lakes to ridges more than 20 m high. The Spearwood Dunes are divided mainly on the depth of soil over the limestone substrate and the incidence of karst features. The Quindalup Dunes occur mainly along the coast.

The major agricultural activity in the Gnangara area is intensive horticulture, predominantly vegetables, native and greenhouse flowers, citrus, avocados, stone fruit, grapevines, turf and nursery crops. The majority of production is situated on the sandy soils of the Spearwood and Bassendean dune systems. Intensive agriculture is the largest private user of groundwater from the Gnangara Mound. All

¹ CSIRO Land and Water, Private Bag No 5, PO Wembley, Western Australia 6913

irrigation supplies required by market gardens are withdrawn from groundwater wells. Due to the excessive use of fertilisers, the poor retaining capacity of the sandy soils, and the relatively shallow depth to groundwater in agricultural areas, nutrients are readily leached to the groundwater aquifers. Natural background NO₃-N concentrations in bores in the agricultural areas are up to 88 mg/L; however, P concentrations are relatively low (median 0.02 mg/L) (Sharma et al. 1991). Several pesticides, notably atrazine and diazinon, have been detected in groundwater from the Gngangara Mound.

Pesticides adversely affect on crop quality and soil health, and have potential to leach and contaminate surface and groundwater resources. The international study involving Australia, Malaysia and Thailand, of which the current study is part, aims to identify and evaluate promising technologies and management options for minimising agrochemical contamination of water resources. The main objectives of the current study are to monitor nutrients and pesticides leaching using different sampling techniques, and to utilise the data to calibrate and validate pesticide-leaching models. The results from the experimental sites have been reported in a companion paper. This paper reports on modelling the effect of applying different management scenarios on the leaching of pesticides and nutrients (Salama, Byrne and Pollock 2001).

Methods

The two experimental sites were located on the Gavin and Joel sands of the Bassendean Dune System sands series, where the groundwater is within two metres of the soil surface and the subsoil has a cemented iron-humus podsol associated with the watertable. The average bulk density of these sands is 1.5 g/cm³ with a greater than 98 per cent sand fraction within virgin soil.

The two sites were installed with free-drainage lysimeters and ceramic suction cups below the beds and under the inter-bed areas in the strawberry farm, and under the turf in the turf farm. A set of multi-level groundwater sampling tubes was installed next to the lysimeters. Data loggers and water-level probes were installed in piezometers to monitor water-level changes in both sites. Irrigation is via two metered overhead sprinklers, two metered 15 mm slotted irrigation lines, and by rainfall. Rainfall events and amounts were recorded by a 0.2 mm tipping-bucket rain gauge. Lysimeters, suction cups, groundwater sampling tubes and piezometers were sampled seven times from 19 September to 17 November 1997. Soil samples were taken from various depths with an alloy

tube. The results of the experimental sites are described in detail in another paper (Salama, Pollock and Byrne 1999).

Description of models

Hornsby Index (HI) and Attenuation Factor (AF) models were used to screen the suite of pesticides commonly used in the Mound. The pesticides with high leaching potential were modelled using CMLS and LEACHP to monitor their movement in the unsaturated zone.

Hornsby Index (HI)

This index measures pesticide leaching potential (Hornsby 1992). The smaller the index, the more likely the pesticide will not be filtered but will leach to the groundwater. The derivation is:

$$HI = (K_{oc} / t_{1/2}) \times 10$$

where

K_{oc} is the organic carbon sorption coefficient

$t_{1/2}$ is pesticide half-life.

AF model

This index is equivalent to the fraction of the applied pesticide mass that is likely to leach past the chosen reference depth, d (Rao and Alley 1993). The value varies between 0 and 1, with larger values indicating a greater contamination potential. The model assumes first-order decay. The derivation is:

$$AF = \exp \frac{-0.693dRF_{FC}}{qt_{1/2}}$$

where

d is the distance from the surface to groundwater

RF is the retardation factor

FC is the volumetric water content at field capacity

q is net groundwater recharge.

RF, the retardation factor accounting for pesticide sorption effects, is given by:

$$RF = 1 + \frac{f_{oc}K_{oc}}{FC}$$

where

b is the soil bulk density (g/cm³)

f_{oc} is fraction of organic carbon.

CMLS model

This is a relatively simple model (Nofziger et al. 1998). It estimates the depth of the peak concentration of a pesticide, and calculates the relative amount of chemical in the soil profile as a function of time after application. The model assumes piston flow and ignores molecular diffusion and hydrodynamic dispersion.

LEACHP

This is the pesticide model in the LEACHM suite (Hutson and Wagenet 1992). It is a mechanistically-based model of water and solute movement and pesticide chemistry. In common with most other models of pesticide movement, it simulates pesticide transformations using first-order kinetics. It has a flexible system for tracking daughter products. The principal difference between LEACHP and simpler models such as CMLS is that water movement is simulated using a numerical solution to Richards' equation in LEACHP, so the model must be supplied with functions to describe water retention and hydraulic conductivity.

The other difference is that LEACHP can simulate the transformation and degradation of the pesticides. Transformation of pesticides in soil can occur through biotic and abiotic ways. In most cases, the pesticides degrade or transform into harmless end-products. However in some cases the metabolites are more toxic than the parent compound and these may increase the toxicity hazard.

Modelling of Pesticide Characteristics

Simple models (Hornsby Index and Attenuation Factor) were used to screen pesticides to indicate those compounds likely to be problematic for water resources. More complex models (CMLS, LEACHP, and regional models) were then used to assess selected pesticides to monitor their movement in the unsaturated zone. Model predictions were then compared with results from the field sites.

Hornsby Index

The results of the analysis of the Hornsby index (Table 1) showed that monocrotophos, dicamba salt, carbofuran, pentachlorophenol, metalaxyl, methamidophos, trichlorfon, aldicarb, metribuzin, atrazine, bentazon, fenarimol, 2,4-D acid, ethoprop, dimethoate and lindane all have high leaching potential.

AF model

The AF model was used to screen the highly leachable pesticides. Four different types of soils were used (Table 2). Although some other soils had a higher organic carbon content than the selected soils, those with the lowest organic carbon were used as these are the most vulnerable to leaching of pesticides.

For each soil, the pesticides lying below the specific soil line in Figure 1 have relatively low potential for contaminating groundwater, because they have sufficiently long residence time or short half-life, or both (Rao and Alley 1993). Those pesti-

Table 1. Leaching potential of the most commonly used pesticides.

Pesticide	Sorption (K _{oc})	Half-life (days)	Leaching Potential (Hornsby Index (HI))
High leaching			
monocrotophos (1)	1	30	0
dicamba salt (2)	2	14	1
carbofuran (7)	22	50	4
pentachlorophenol (9)	30	48	6
metalaxyl (12)	50	70	7
methamidophos (3)	5	6	8
trichlorfon (4)	10	10	10
aldicarb (8)	30	30	10
metribuzin (13)	60	40	15
atrazine (15)	100	60	17
bentazon sodium salt (10)	34	20	17
fenarimol (19)	600	360	17
2,4-D acid (5)	20	10	20
ethoprop (ethoprophos) (14)	70	25	28
dimethoate (6)	20	7	29
lindane (22)	1100	400	28
Intermediate filtration			
linuron (17)	400	60	67
prometryn (18)	400	60	67
alachlor (16)	170	15	113
dieldrin (33)	12 000	1000	120
aldrin (28)	5000	365	137
mevinphos (11)	44	3	147
diazinon (21)	1000	40	250
fenbutatin oxide (27)	2300	90	256
mancozeb (25)	2000	70	286
chlorothalonil (23)	1380	30	460
iprodione (20)	700	14	500
chlordan (35)	20 000	350	571
MCPA dimethylamine (26)	2000	25	800
heptachlor (36)	24 000	250	960
trifluralin (31)	8000	60	1333
fenvalerate (30)	5300	35	1514
High filtration			
endosulfan (34)	12400	50	2480
DDT (38)	2 000 000	2000	10 000
methyl parathion (29)	5100	5	10 200
bromoxynil octanoate (32)	10 000	7	14 286
malathion (24)	1800	1	18 000
permethrin (37)	100 000	30	33 333

Note: Numbers between brackets refer to numbers in Figure 1.

cides that lie above the line have relatively large contamination potential, because they degrade slowly or leach rapidly, or both. Using these criteria, the results of modelling the four types of soils showed that the Gavin soils have high filtration potential and only two pesticides, carbofuran and metalaxyl seem to have the potential to leach through them. In the

Table 2. Soil characteristics from the Gngangara Mound used in AF modelling.

Soil-type	Characteristic		
	Bulk Density (g/cm ³)	Fraction of Organic Carbon	Volumetric Field Capacity (%)
Karrakatta Yellow (Ky)	1.62	0.0010	0.31
Spearwood Sand (Sp)	1.59	0.0016	0.30
Gavin (G)	1.52	0.0045	0.35
Jandakot (Ja)	1.62	0.0014	0.32

Table 3. Model soil parameters used to run the LEACHP model.

Parameter	Soil Layer	Bassendean Sands				Spearwood Sands		
		G (Bb)	G (P)	Ja	J	Kls	Ky	Sp
OC	topsoil	2.94	4.80	1.02	2.90	1.05	0.82	2.50
	subsoil	0.56	0.66	0.14	0.89	0.48	0.49	0.25
v	topsoil	0.45	0.50	0.38	0.52	0.43	0.36	0.48
	subsoil	0.37	0.40	0.35	0.39	0.41	0.42	0.40
BD	topsoil	1.480	1.379	1.458	1.229	1.386	1.387	1.220
	subsoil	1.535	1.489	1.601	1.488	1.599	1.568	1.562
K	topsoil	1480	2380	562	2140	6380	2850	422
	subsoil	3410	3100	6120	4260	4410	4770	3630

Notes: **Parameters**

OC = Organic Carbon (%), v_v = volumetric water content (%), BD = bulk density (g/cm³), K = hydraulic conductivity (mm/d)

Soil Systems & Units

Bassendean Dunes: G = Gavin, Ja = Jandakot, J = Joel

Spearwood Dunes: Kls = Limestone, Ky = Karrakatta Yellow, Sp = Spearwood

Landuses

Bb = Banksia bush, P= pines.

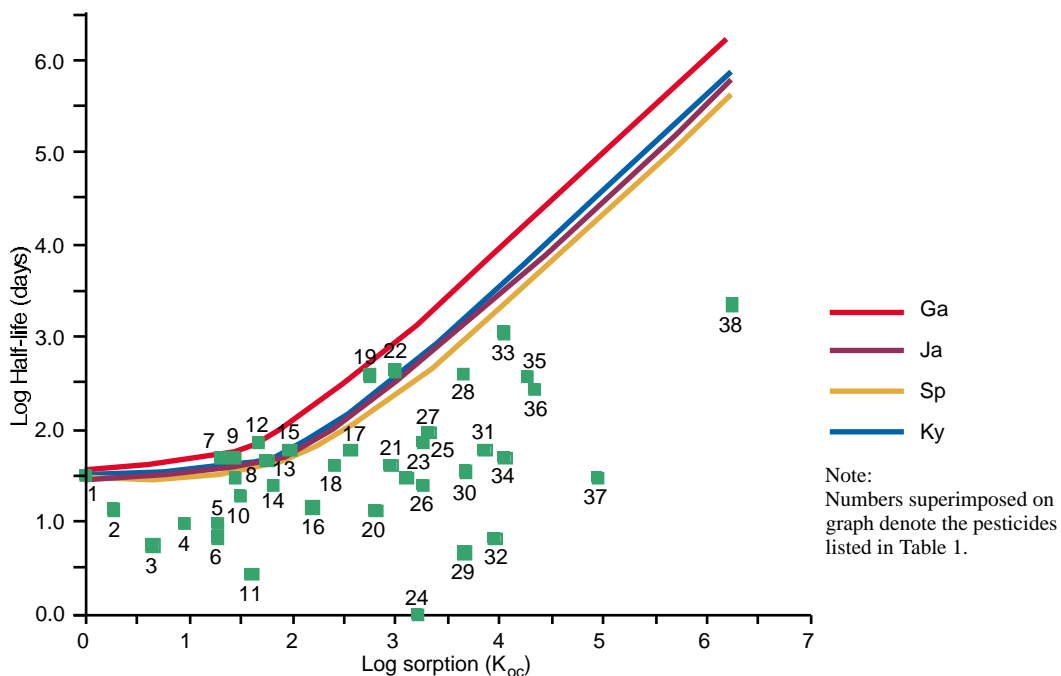

Figure 1. Soil-type control on pesticide attenuation in the Gngangara Mound.

Table 4. Model pesticide parameters used to run LEACHP.

Parameter	Atrazine	DEA	DIA	Fenamiphos	F sulfoxide	F sulfone	Fenarimol	Prometryn	Simazine
Solubility (mg/L)	33	33	33	330	330	330	14	33	6.2
Degradation 1				0.0010	0.0200	0.0250	0.0019	0.0116	0.0116
Degradation 2				0.0010	0.0050	0.0500	0.0019	0.0116	0.0116
Transformation 1	0.014	0.210		0.500	0.005				
Transformation 2	0.003	0.038		0.020	0.005				

Spearwood and Jandakot sands that have lower filtration capacity, an additional four pesticides have the potential of leaching through. These are fenarimol, lindane, atrazine and pentachlorophenol. The Karrakatta soils have the least capacity of filtering pesticides and two additional pesticides (metribuzin and monocrotophos) have the potential to leach through it. All the other pesticides used in the Gngangara Mound do not have the potential to leach through the different soils. On the other hand, if the organic carbon of the soil were increased by one per cent, which is the case in several areas, all these pesticides would be filtered in the top 20 cm.

CMLS

This was used to model leaching of commonly used pesticides in Australia using soil data from the two farms in the Gngangara Mound. The results showed that malathion, diazinon, endosulfan, iprodione, benomyl, thiram and chlorpyrifos are all highly adsorbed to the Gngangara soils and are not leached below the top 10 cm layer of the soil. On the other hand, dicamba and dimethoate leach very quickly to below one metre but, due to their short half-lives, they degrade quickly and the amount remaining in the soil after the first week of application is very small. Atrazine on the other hand has higher sorption than dicamba and dimethoate, but due to its long half-life, persists for a long time in the soil so in most cases small amounts of the pesticide are leached to groundwater.

In the field study, using recommended application rates, none of the tested pesticides (atrazine, diazinon, dimethoate, endosulfan, fenamaphos, iprodione, malathion, and chlorpyrifos) were detected in the groundwater samples collected by the different techniques from depths ranging from 30 cm to 2.0 m. This largely confirms the modelling results.

Modelling of Management Scenarios

Scenarios to reduce pesticide leaching

The LEACHP model was used to simulate the leaching of pesticides used in the two farms in the Gngangara Mound. Atrazine and its two daughters, desethylatrazine (DEA) and desisopropylatrazine

(DIA), fenamiphos and its two daughters, fenamiphos sulfoxide and fenamiphos sulfone, fenarimol and prometryn were modelled for the three main Spearwood soils where most of the agricultural activity takes place. Tables 3 and 4 detail the soil and pesticide properties used to run the model.

Several simulations were carried out to find out the effect of the different management scenarios on the leaching of the pesticides. In a test-run scenario, the applied pesticide was reduced by half. The results showed that reducing the pesticide by half will reduce the chemical content and flux by half. Four scenarios were applied:

- applied irrigation is the recommended rate of 100 per cent of pan evaporation
- irrigation applied by the farmers (11mm/day)
- organic carbon is doubled (2OC), with irrigation water of Scenario 1
- organic carbon is doubled, with irrigation water of Scenario 2.

The results showed that by applying Scenario 1 (optimum irrigation rates), the travel time of the pesticide will increase and a higher proportion of the pesticide will be retained in the top layer, thus giving it more chance to degrade. Ky soils have a high filtration capacity to all the modelled pesticides followed by the Kls, while the Sp has the lowest filtration capacity. The results also showed that even at the recommended irrigation rates (Scenario 1) the daughter products, DIA and fenamiphos sulfoxide, are more leachable and more persistent than their parent compounds. Fenamiphos sulfoxide has the earliest breakthrough curve and the highest amount of leaching below the 80 cm subsurface layer (Table 5). As expected, Scenario 3 (double organic carbon) gave the best results with minimal pesticide breaking through the 80 cm layer.

Under excessive irrigation (Scenario 2), atrazine persisted for 100 days in Kls topsoil, and for less than 200 days in the subsoil (Table 6). It leached below the topsoil in about 100 days in Ky, and persisted in the subsoil for more than 200 days. Atrazine daughter products disappeared from the topsoil of Ky after nearly 100 days, and persisted in the subsoil for about 200 days. Atrazine persisted for a shorter time in Sp, as much of it leached below the subsoil.

Table 5. Pesticide leaching through 80 cm layer in Spearwood sands.

Scenario	Fenamiphos Sulfoxide, by Soil-type (%)		
	Kls	Ky	Sp
1	47	39	61
2	74	68	81
3	33	27	63
4	64	59	81

Table 6. Pesticide remaining in the topsoil and subsoil after 100 days in Spearwood sands.

Scenario	Atrazine by Soil Layer & Type (%)					
	Topsoil			Subsoil		
	Kls	Ky	Sp	Kls	Ky	Sp
1	12	10	27	37	43	16
2	2	3	8	13	20	9
3	21	19	7	24	31	36
4	6	5	14	33	39	19

Atrazine and its two daughters, DEA and DIA, and simazine were also modelled for the three main soils in the Bassendean sands, Gavin, Jandakot and Joel. Two simulations were carried out for the Gavin soils, one under pines and the other under native Banksia. The results showed that due to the absence of irrigation and the low water content of the surface and subsurface soil horizons (due to the plant water uptake), atrazine did not leach below the subsurface zone and most of the herbicides were filtered on the top surface layer (Table 7). Smaller amounts of simazine, which is more mobile than atrazine, passed below the subsoil (Table 8).

Table 7. Pesticides breaking through the 80 cm layer in Bassendean sands.

Pesticide Name	Pesticide, by Soil-type (%)			
	Gavin (Bb)	Gavin (P)	Jandakot	Joel
atrazine	0	0	8	0
desethylatrazine	0	0	3	0
desisopropylatrazine	1	0	17	0
simazine	4	20	24	12

Table 8. Pesticide remaining in topsoil and subsoil after 100 days in Bassendean sands.

Soil Layer	Atrazine by Soil-type & Layer (%)			
	Gavin (Bb)	Gavin (P)	Jandakot	Joel
topsoil	37	40	30	36
subsoil	2	0	14	1

Scenarios to reduce nutrient leaching

The LEACHN model was used to simulate the leaching of nitrogenous fertilisers as applied to both urban and agricultural areas. The model was also used to simulate several management scenarios of fertiliser and irrigation applications.

Table 9. Recommended application rates of fertilisers used in the LEACHN model.

Application Date	Fertiliser (kg/ha)		
	Urea	NH ₄	NO ₃
12/05/98	00.00	27.20	26.90
26/05/98	00.00	13.60	21.70
09/06/98	00.00	13.60	21.70
23/06/98	00.00	00.00	26.90
07/07/98	00.00	00.00	26.90
21/07/98	00.00	00.00	26.90
04/08/98	00.00	17.00	16.80
18/08/98	00.00	17.00	16.80
01/09/98	00.00	17.00	16.80
15/09/98	18.40	00.00	26.40
29/09/98	18.40	00.00	26.40
13/10/98	04.60	00.00	30.30
27/10/98	04.60	00.00	30.30
10/11/98	04.60	00.00	30.30
24/11/98	00.00	00.00	26.70
09/12/98	00.00	00.00	26.70
23/12/98	00.00	00.00	33.60

In the urban area, ammonium was applied twice during the dry season at the rate of 70 kg/ha, while irrigation was applied at the rate of 3 mm every second day. The results showed that ammonium disappears from the top layer in less than 50 days in all three types of soils: Kls, Ky and Sp. Also after 100 days, 600 mg/m² of nitrate leaches to the 50–80 cm layer in Kls, 1000 mg/m² in Ky, and 300 mg/m² in Sp.

Table 10. Nitrate leaching below 80 cm after 250 days.

Scenario	NO ₃ -N, by Soil-type (kg/ha)		
	Kls	Ky	Sp
I	360	300	330
II	480	410	460
III	16	120	150

In the horticulture area, three scenarios were applied, the results of which are shown in Tables 10 and 11.

Scenario I

The recommended rates of fertilisers were applied (Table 9), and the irrigation was also the recommended rate of 100 per cent pan evaporation.

Scenario II

The irrigation rate was increased to 11 mm/day, which is the level used by the farmers. The farmers apply

Table 11. Ammonium and nitrate in various layers after 250 days.

Scenario	Sample Depth (cm)	NH ₄ -N & NO ₃ -N, by Soil-type (mg/m ²)					
		KIs		Ky		Sp	
		NH ₄ -N	NO ₃ -N	NH ₄ -N	NO ₃ -N	NH ₄ -N	NO ₃ -N
I	0–20	250	1800	250	1800	400	2800
	20–50	250	2600	350	3600	350	3000
	50–80	10	2600	100	2900	0	500
II	0–20	60	250	50	400	100	400
	20–50	100	510	150	1200	120	600
	50–80	60	850	100	1300	60	1100
III	0–20	160	800	150	800	180	1400
	20–50	160	1300	160	1600	160	1500
	50–80	0	1300	50	1450	0	1750

sprinkler irrigation two or three times per day for water supply and for cooling during the hot summer days.

Scenario III

The fertiliser application rate was decreased to half the recommended application rate, while keeping the irrigation rate at pan evaporation.

By increasing the rate of water application (Scenario II), most of the nutrients were leached below the topsoil horizons as shown by the lower nutrient content in all three layers by comparison with the other two scenarios.

Scenario III, where half the amount of fertiliser was applied together with the pan evaporation water, caused the least amount of nutrients to leach through the 80 cm layer. Of the three soils, KIs was the best soil for retaining most of the nutrients; only 16 kg/ha passed through the 80 cm layer, while 120 kg/ha passed through Ky, and 150 kg/ha passed through Sp.

Conclusions

Most of the reported incidents of pesticides in groundwater are caused by excessive application of pesticides or excessive irrigation, or both. In Australia, most of such incidents are due to malpractice or misadventure such as a spill. The results of this study showed that in normal use only a small number of pesticides have the potential to contaminate the Gngangara Mound aquifer. Furthermore with proper management the risk of contamination could be greatly reduced. Reducing the application rates of pesticides to the recommended rates and adopting better irrigation practices will minimise contamination potential. Increasing the organic matter of the top 10 cm would greatly enhance the filtering capacity of the soils, and in most cases none of the pesticides would leach down to the aquifer.

This study suggests that indicate that the most effective management to reduce nutrients leaching is by reducing fertiliser application rates and applying the optimum irrigation rates. The Karrakatta limestone sand appears to be the best soil to retain most of the nutrients.

References

- Davidson, W.A. 1995. Hydrogeology and Groundwater Resources of the Perth Region, Western Australia. Geological Survey of Western Australia, Bulletin 142, 257pp.
- Hornsby, A.G. 1992. Site-specific pesticide recommendations: the final step in environmental impact prevention. *Weed Technology* 6: 736–742.
- Hutson, J.L. and Wagenet, R.J. 1992. LEACHM: Leaching Estimation and Chemistry Model. Version 3. Cornell Univeristy, New York.
- Nofziger, D.L., Chen, J.S., Wu, J., Ma, F. and Hornsby, A.G. 1998. The chemical movement in layered soils. Model for batch processing. Division of Agricultural Sciences and Natural Resources, Oklahoma State University.
- Rao, P.S.C. and Alley, W. M. 1993. Pesticides. *In*: Alley, W.M., ed., Regional Groundwater Quality. VNR, New York, 345–382.
- Salama, R.B., Byrne, J.D. and Pollock, D.W. 2001. Nutrient and pesticide leaching in experimental sites in the Swan Coastal Plain. *These Proceedings*.
- Salama, R.B., Pollock, D. and Byrne, J. 1999. Experimental and modelling results of pesticide leaching in agricultural systems: Examples from Thailand, Malaysia and Australia. *Solutions and Innovations. Proceedings of International Conference on Diffuse Pollution, Perth, Western Australia, 16–20 May*.
- Sharma, M.L., Byrne, J.D.M., Herne, D.E. and Kin, P.G. 1991. Impact of horticulture on water and nutrient fluxes to a sandy aquifer. CSIRO Division of Water Resources Report No. 91/33.

Regional Vulnerability to Nutrient Leaching in the Gngangara Mound under Different Management Scenarios

R.B. Salama, D.W. Pollock and J.D. Byrne¹

Abstract

Regional groundwater vulnerability maps that indicate the impact of leaching of nutrients under different management scenarios were prepared for the Gngangara Mound using the LEACHN model and GIS techniques. The results were up-scaled using soil maps under three different management scenarios and different rates of fertiliser application. In the first scenario, the optimum recommended rate of fertiliser application and recommended irrigation rate of 100 per cent pan evaporation were applied. In the second scenario, the application of fertiliser was the same as in the first, but the irrigation rate was increased to 11 mm/day, which is the level used by the farmers. In the third scenario, the fertiliser application rate was decreased to half the recommended application rate while keeping the irrigation rate at pan evaporation. Vulnerability to nutrient leaching was highly dependent on the rate of fertiliser application and the amount of irrigation water. In the urban areas, the amount of NO₃-N leaching below the 80 cm horizon was not more than 50 kg/ha in all three scenarios; but due to the larger areas involved compared with the agricultural area, the total load that reaches the groundwater from urban areas would be more. Regionally, nitrate was found to be above the limit in eight sites, mainly in the horticultural areas on Spearwood sands.

THE SANDY SOILS of the Gngangara Mound are highly porous, and usually of very high permeability and low organic matter content. Excessive amounts of nutrients are used in the agricultural areas to compensate for losses due to leaching by excess irrigation and rain. High levels of nitrate-N concentrations are reported in groundwater below horticultural properties.

Increasing inputs of organic and inorganic fertilisers in urban and agricultural areas are causing an increase in the amount of nutrients leached into groundwater in the Gngangara Mound aquifers. Nitrate-N usually leaches rapidly through the sandy soils to the groundwater, especially when the groundwater is near to the surface. On the other hand, phosphorus is adsorbed strongly in the topsoils that have higher clays and organic matter and does not leach as well as nitrogen. The main sources of nitrate on the Gngangara Mound are: agriculture, grazing, horticulture, and semi-rural or urban developments; the latter includes septic systems, unsewered or sewerred resi-

dential areas, lawns, gardens, parks, fertilisers applied to sports grounds, and leachate from landfills.

The rate of fertiliser application varies considerably between private lawns, public parks and market gardens. At the same time, irrigation water is applied at different rates and at different times, which makes the rates of recharge from irrigation from these different situations very variable.

Method and Results

This study takes into account results from a previous study for nutrient leaching and balances in urban areas (Sharma et al. 1995), as well as recent data collected from market gardens, and studies of phosphorus and nitrate loss from horticulture on the Swan Coastal Plain (Lantzke 1997). The nutrient balances were used to calibrate the LEACHN model and to study the regional distribution of leaching.

¹ CSIRO Land and Water, Private Bag No 5, PO Wembley, Western Australia 6913

Nutrient leaching in urban and horticultural areas, and the region

Urban areas

In urban areas leached nitrogen was measured in the form of $\text{NO}_3\text{-N}$ and $\text{NH}_4\text{-N}$. Leaching was higher in summer than in winter, and at most sites $\text{NO}_3\text{-N}$ concentrations approached or exceed UN World Health Organisation drinking-water limits during some parts of the year (Sharma et al. 1995). Leaching on Bassendean sands was higher than on the Spearwood sands.

The ratio of N_{out} (output in leachate) to N_{in} (input through fertiliser and irrigation) varied considerably from site to site, ranging from 0.09 to 0.30. Much higher proportions of applied N were found to be leaching beneath Bassendean sands (about 23 per cent) than under Spearwood sands (about 10 per cent). Over this period, public sites generally received far less N input (135 kg/ha) than private sites

(350 kg/ha), yet the average yields in leachate were similar (public, 31; private, 39 kg/ha). This resulted in a much higher $N_{\text{out}}/N_{\text{in}}$ ratio for public (0.23) than private sites (0.12). Most of the fertiliser was applied during summer, so N concentrations in leachate were significantly higher in summer than in winter (Tables 1 and 2).

The long-term average phosphate concentrations were much higher in the Bassendean sands (0.81 mg/L) than the Spearwood (0.015 mg/L), due to the higher adsorption capacity of the latter (Gerritse, Barber and Adney 1990). Higher than expected phosphorus concentrations were encountered from the Corderoy site, attributed to previous higher applications (Barber et al. 1991). The lower than expected phosphorus levels in one of the Bassendean sites was attributed to recent establishment of the site, meaning that P is still being adsorbed in the soils (Sharma et al. 1995).

Table 1. Water balance for urban and horticultural sites.

Site	Inputs (mm)				Outputs (mm)		Ratios			
	R	P	I	IT	Et	Ep	R/IT	I/IT	IT/Ep	Et/Ep
Urban										
Noranda	846	849	1413	2262	1416	2013	0.374	0.625	1.124	0.703
Tuart Hill	480	659	753	1411	931	2013	0.340	0.533	0.701	0.462
Mt Lawley	876	734	990	1724	848	2013	0.508	0.574	0.856	0.421
Karrinyup	291	723	745	1468	1177	2013	0.198	0.507	0.729	0.585
Cordeory	696	705	1193	1898	1202	2013	0.367	0.629	0.943	0.597
Balcatta	251	792	642	1434	1183	2013	0.175	0.448	0.712	0.588
Ballajura	1205	848	1543	2392	1187	2013	0.504	0.645	1.188	0.590
Waterman	265	654	769	1423	1158	2013	0.186	0.541	0.707	0.575
Horticultural										
Strawberry farm	226.0	430.6	426.0	856.6	630.6	423.2	0.264	0.497	2.024	1.490
Turf farm	153.6	134.0	115.6	249.6	96.0	324.5	0.615	0.463	0.769	0.296

Notes: R = recharge, P= precipitation, I = irrigation, IT= total water input (including recharge), Et = estimated evapotranspiration, Ep = 'Class A' pan evaporation.

Table 2. Nutrient balance for urban and horticultural sites (lysimeter data).

Site	Flow-weighted Concentration (mg/L)					Yield (kg/ha)				
	$\text{NO}_3\text{-N}$	$\text{NH}_4\text{-N}$	Total N	$\text{PO}_4\text{-P}$	Cl	$\text{NO}_3\text{-N}$	$\text{NH}_4\text{-N}$	Total N	$\text{PO}_4\text{-P}$	Cl
Urban										
Noranda	4.12	0.64	4.76	0.034	129	218	33.75	251.80	1.81	6810
Tuart Hill	1.56	0.01	1.57	0.002	104	47	0.44	47.44	0.06	3113
Mt. Lawley	2.68	0.59	3.27	0.010	125	147	32.50	179.50	0.56	6857
Karrinyup	2.65	0.02	2.67	0.034	175	48	0.38	48.38	0.63	3190
Cordeory	5.33	1.10	6.43	0.040	60	232	47.81	279.80	2.00	2597
Balcatta	4.04	na	4.04	0.008	110	63	na	63.00	0.13	1733
Ballajura	5.37	0.07	5.44	0.003	38	404	5.06	409.10	0.25	2857
Waterman	0.83	na	0.83	0.015	111	14	na	14.00	0.25	1842
Horticultural										
Strawberry farm	34.62	3.22	37.84	6.740	30	61	5.67	66.69	11.88	52
Turf farm	49.56	5.39	54.95	4.320	119	84	9.19	93.64	7.37	203

Note: na = not available

In a GIS-based study carried out in a groundwater supply field in the Gnamptara Mound (Barber, Otto and Bates 1996), it was found that groundwater quality was affected by increasing nitrate. Nitrate concentrations down-gradient from older unsewered urban areas exceeded 10 mg/L NO₃-N in production wells. The study showed that the full impact of the unsewered urban development would occur in approximately 15–20 years.

Horticultural areas

High to very high NO₃-N concentrations were found in the shallow groundwater beneath the production areas in ten properties investigated by Lantzke (1997). The high NO₃-N concentrations reached the bottom of the superficial aquifer in only two properties. Due to denitrification, NO₃-N levels did not persist more than 50–100 m away from the high zones.

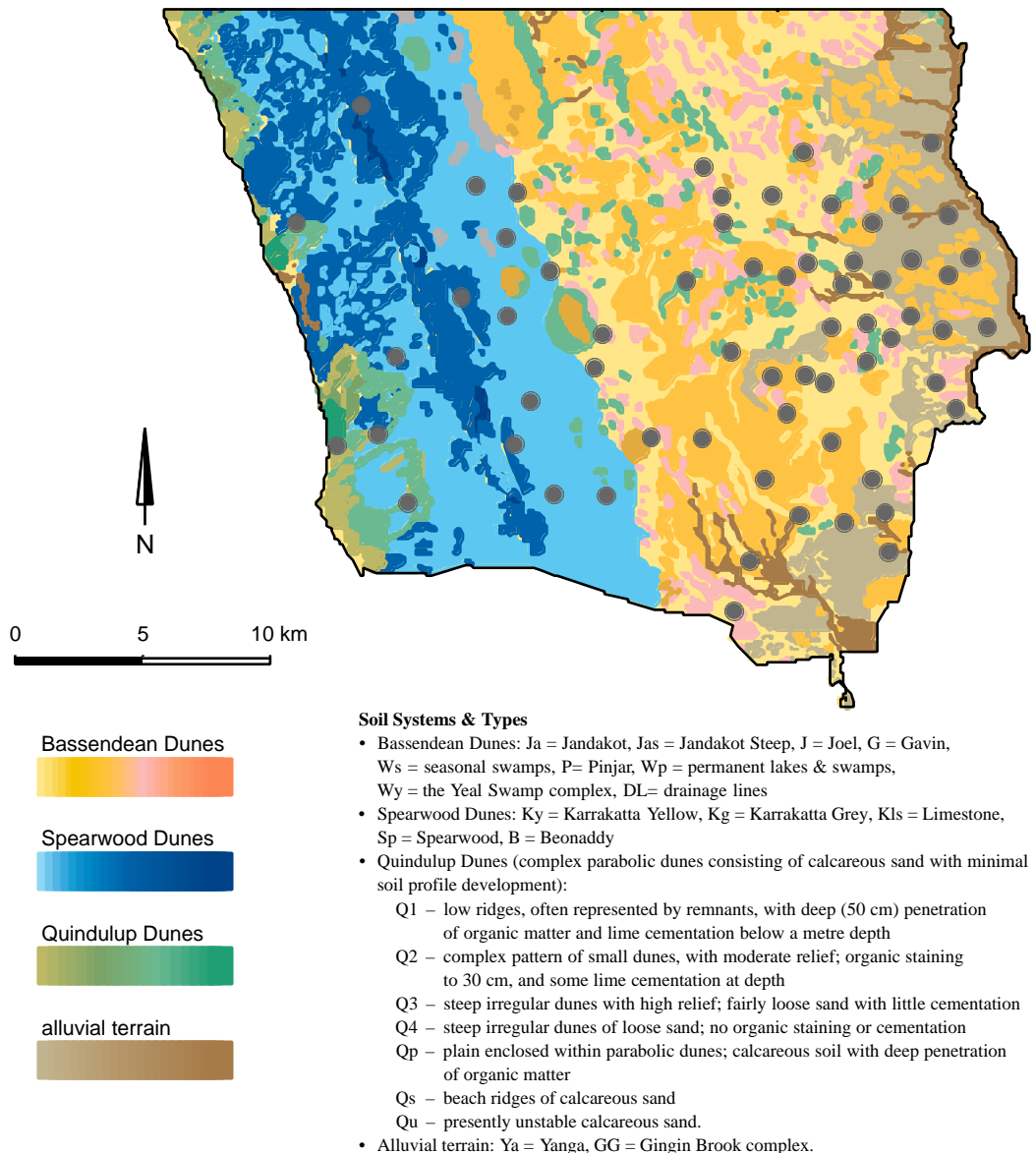
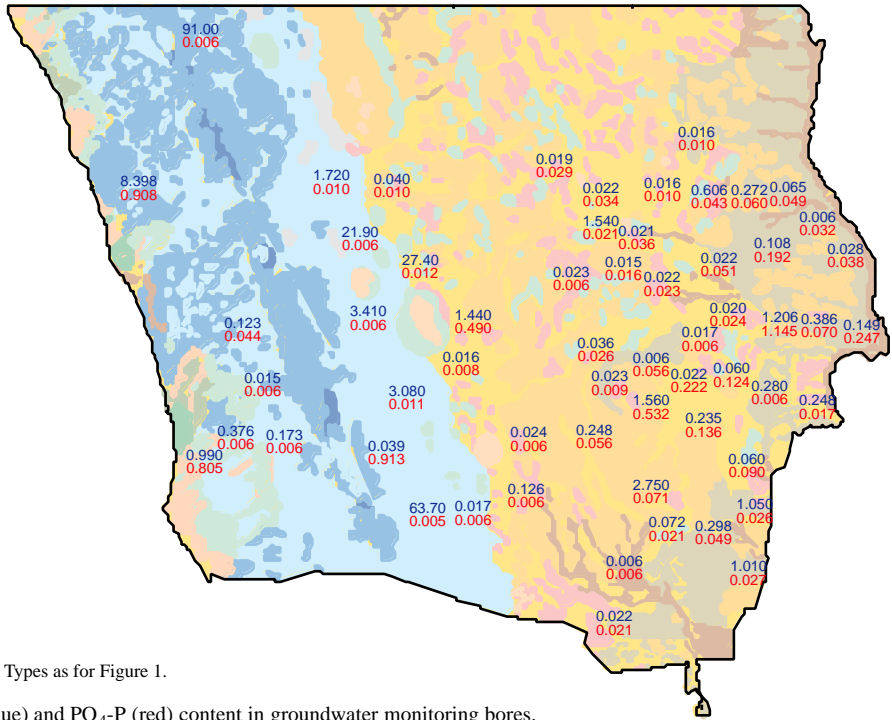

Figure 1. Groundwater sampling sites.



Note: Soil Systems and Types as for Figure 1.

Figure 2. NO₃-N (blue) and PO₄-P (red) content in groundwater monitoring bores.

Detailed studies of nutrient leaching in strawberry and turf farms were also carried out in 1998 (Salama, Pollock and Byrne 1999). The results in both locations showed that because of excessive application of nutrients, NH₄ and NO₃ leach to the groundwater at high rates. The N levels (15–54 mg/L) were above the acceptable limits in the top 1.6 m of the shallow aquifer system. This trend decreased abruptly below 2.0 m where the concentrations were <1 mg/L. Phosphorus increased with time and decreased with depth; the concentrations were 4–10 mg/L above 1.6 m, and 2–4 mg/L below that depth. Ammonium-N concentrations ranged from <1 to 4 mg/L in the top 60 cm.

The region

Groundwater nitrate-N concentrations within the Gngangara Mound and surrounding areas are generally low. In a survey of 70 private and public wells in the Gngangara Mound, most of the wells that contained high nitrate-N levels were within the horticultural areas in the Spearwood sand. In eight wells the nitrate level exceeded 10 mg/L, and in two wells it exceeded 50 mg/L (PM34 = 91 mg/L; MM14 = 68 mg/L). In two other wells the nitrate-N was equal to or more than 5 mg/L; in all the others it

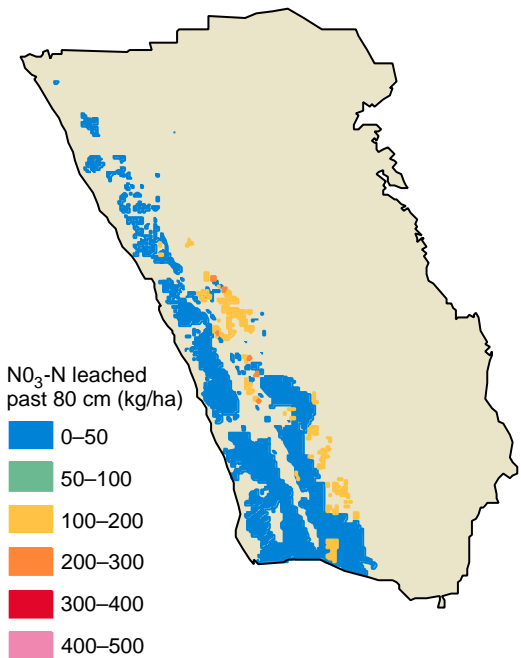

Figure 3(a). Nitrate-N leaching for Scenario 1.

was below 5 mg/L, with most below 1 mg/L. Phosphate P levels were very low in all sampled wells. Sampling sites and results are summarised in Figures 1 and 2, respectively.

Regional vulnerability to nutrient leaching

In this study, the method used GIS for mapping aquifer vulnerability, incorporating the information on soils, landform and landuse maps. The LEACHN model was used to simulate the leaching of nitrogenous fertilisers as applied to both urban and agricultural areas. The model was also used to simulate several management scenarios of fertiliser and irrigation applications.

For the urban areas, ammonium-N was applied twice during the dry season at the rate of 70 kg/ha, while irrigation was applied at the rate of 3 mm every second day. Ammonium-N disappeared from the top layer in less than 50 days in all three types of soil: Kls, Ky and Sp of the Spearwood Sands. Also after 100 days about 600 mg/m² of NO₃-N leached to the 50–80 cm layer in the Kls, 1000 mg/m² in the Ky, and 300 mg/m² in the Sp.

In the horticulture area, three scenarios were applied, the results of which are detailed in Salama, Pollock and Byrne (2001) and illustrated in Figure 3.

The scenarios are as follows.

Scenario 1:

The recommended rates of fertilisers were applied (Table 9), and the irrigation was also the recommended rate of 100 per cent pan evaporation.

Scenario 2:

The irrigation rate was increased to 11 mm/day, which is the level used by the farmers. The farmers apply sprinkler irrigation two or three times per day for water supply and for cooling during the hot summer days.

Scenario 3:

The fertiliser application rate was decreased to half the recommended application rate, while keeping the irrigation rate at pan evaporation.

Scenario 3, where half the amount of fertiliser was applied together with the pan evaporation water, shows the least amount of nutrients leaching through the 80 cm layer. Of the three soils, the Kls retained most of the nutrients, as only 16 kg/ha of NO₃ passed through the 80 cm layer, while 120 kg/ha passed in the Ky and 150 kg/ha passed in the Sp.

In Scenario 1, leaching of NO₃ in most of the horticultural areas was 300–350 kg/ha, with four sites exceeding 400 kg/ha. In Scenario 2, where higher

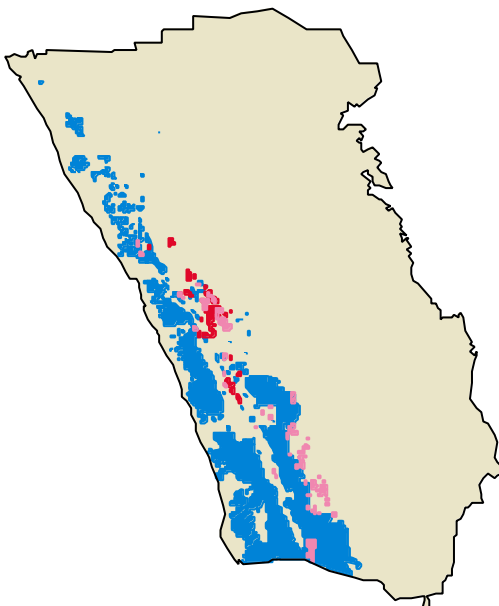

Figure 3(b). Nitrate-N leaching for Scenario 2.

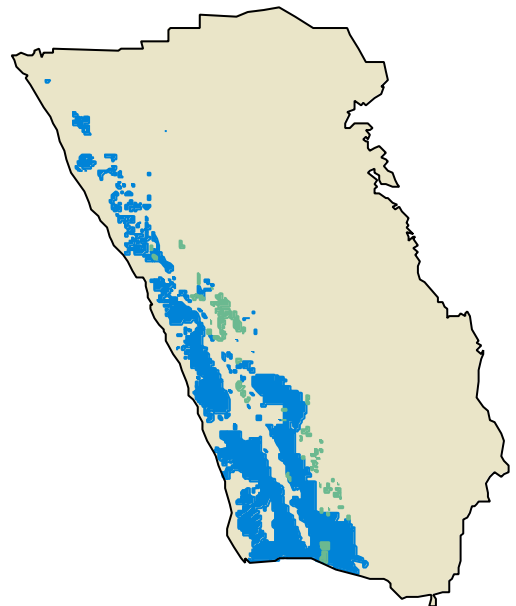
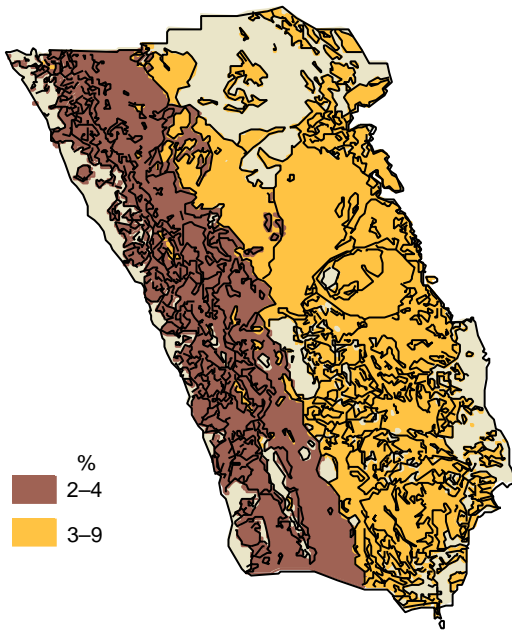

Figure 3(c). Nitrate-N leaching for Scenario 3.



Note: The blank areas on the map are regions with unknown organic carbon content, including the Quindalup Dunes and various wetlands.

Figure 4. Denitrification rates.

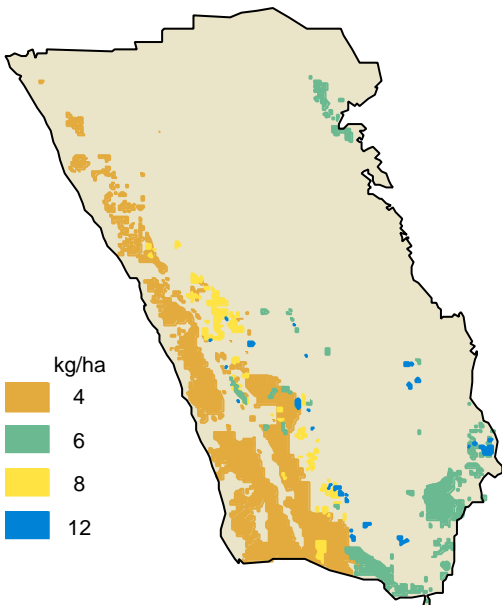

Figure 5. Denitrification amounts.

irrigation rates were used, leaching in most sites was more than 400 kg/ha, and in several sites the NO_3 leaching exceeded 450 kg/ha. When the nutrient and water applications were reduced as in Scenario 3, only 100–150 kg/ha leached below the 80 cm horizon.

In the urban areas, the amount of nitrate-N leaching below the 80 cm horizon was less than 50 kg/ha in all three scenarios; however, since the areas where fertilisers are applied are larger than in the agricultural areas, the total load which reaches the groundwater from the urban areas is likely to be higher.

Discussion

Denitrification in the unsaturated zone

The main factor affecting denitrification is availability of oxygen in soil and groundwater, which often relates to the amount of organic carbon and redox conditions. In general, the higher the water content and organic carbon content of a soil, the less oxygen the soil contains, and so the higher the denitrification rate. Meisinger and Randall (1991) devised an index which can be used to estimate the denitrification rate in a soil, based on the above properties. The organic carbon content of the main soil-types of the Gngara Mound for different landuses were used for the denitrification studies. These data are shown in Table 3.

Table 3. Organic Carbon content for different soils and landuses.

Soil-type	Organic Carbon (%)			Average
	Mg	P	V	
G	1.04	3.28	2.68	2.57
Ja	–	–	1.10	1.10
J	–	–	2.02	2.02
<hr style="border-top: 1px dashed black;"/>				
B	2.14	–	2.50	2.32
Kg	1.10	–	–	1.10
Kls	0.92	–	–	0.92
Ky	0.73	–	0.84	0.77
Sp	0.84	–	2.00	1.23

Notes: Soil Systems & Types

- Bassendean Dunes: G = Gavin, Ja = Jandakot, J = Joel
- Spearwood Dunes: B = Beonaddy, Kg = Karrakatta Grey, Kls = Limestone, Ky = Karrakatta Yellow, Sp = Spearwood

Landuses

- Mg = market gardens, P = pines, V = vegetables

The organic carbon values in Table 3 were converted to denitrification rates; organic matter values were estimated by doubling the organic carbon values shown in Table 3. The Gngangara Mound Soils are considered to be excessively well drained, therefore only the 'Excessively Well Drained' column from the Meisinger and Randall table is shown in Table 4.

Table 4. Denitrification rates for various proportions of organic matter in 'excessively well drained' soil.

Organic Matter (%)	Denitrification Rate (%)
<2	2-4
2-5	3-9
>5	4-12

Denitrification rates were estimated from the range specified in the Meisinger and Randall index. The calculations show that the Bassendean sands (G, Ja, J, Jas) had denitrification rates in the range 3-9 per cent. Of the Spearwood sands, B and Kg had denitrification rates of 3-9 per cent, while Kl, Ky and Sp were 2-4 per cent. Broadly speaking, this means that the Spearwood sands (which are located closer to the coast) have lower denitrification rates than the Bassendean sands (which are located further inland).

Figure 4 shows the clear distinction between the soils with the lower denitrification rate and those with the higher denitrification rate. The reason for this clear distinction is that the Bassendean sands generally have a higher organic carbon content and therefore higher denitrification rate than the Spearwood sands.

The other factor that needed to be considered was the amount of nitrogen applied to the soil. Different landuses require different amounts of nitrogen. For the purposes of this study, it was assumed that 140 kg/ha of N is applied annually to the soil in urban areas, and 203.2 kg/ha in market garden areas. Landuse and soil maps were then used in a GIS to produce a map of the Gngangara Mound showing the amount of nitrogen denitrified (Figure 5).

Management issues

Considerable progress has been made towards reducing pollution problems; nevertheless, it is difficult to control non-point source (NPS) pollution. This is mainly due to economic as well as regulatory difficulties that arise in the control of NPS. In most cases, NPS problems involve the use of several pesticides and nutrients from different plots, sub-catchments and catchments that can be difficult to trace back to one

user. For example, in the Gngangara Mound most of the farmers use nutrients and pesticides at excessive levels. However, only in the areas where groundwater levels are below two metres from the surface do these pollutants reach the groundwater at detectable levels. (Any detectable value is above permissible limits.) In other areas, where the groundwater is usually more than 10 m from the surface, the nutrients are greatly reduced through denitrification, dilution and dispersion.

Conclusions

Regional groundwater vulnerability maps that indicate the impact of leaching of nutrients under different management scenarios were prepared for the Gngangara Mound using the LEACHN model and GIS techniques. The results were upscaled using soil maps under different management scenarios and different rates of fertiliser application. Vulnerability for nutrient leaching was highly dependent on the rate of fertiliser application and the amount of irrigation water. In the urban areas, the amount of NO₃ leaching below the 80 cm horizon was less than 50 kg/ha in all three scenarios but, due to the larger areas where fertilisers were applied, the total load that reaches the groundwater from the urban area is likely to be more than that from the agricultural area. On the regional scale, nitrate was found to be above the limit in eight sites, mainly in the horticultural areas of the Spearwood sands.

Several alternative approaches are available for regulators to control pollution. They include taxes and charges on fertilisers and pesticides, withdrawal of leases, scaling fine system and subsidies. Most of the economic instruments normally recommended with which to target pollution were found not to be applicable in the Gngangara Mound (Nind 1997). The traditional economic paradigm assumes that there is a socially optimal level of pollution. The Nind study suggests that this point cannot be reached before growers are forced out of business.

To reduce NPS pollution, an integrated approach that includes several options is required. There is a need to change current practices and reduce fertiliser application to match crop needs. Wastes from high-density livestock operations need to be managed as a point source of pollution. Wetlands, lakes, and rivers can be used for denitrification; this will reduce the amount of nutrients leaching to the groundwater.

References

- Barber, C., Davis, G.B., Thierrin, J., Bates, L., Patterson, M.B., Pribac, F., Gibbs, R., Power, T., Briegel, D., Lambert, M. and Hosking, J. 1991. Assessment of the Impact of Pollutants on Groundwater Beneath Urban Areas. Final Report. CSIRO Division of Water Resources, Report No. 91/22, 53pp.
- Barber, C., Otto, C.J. and Bates, L.E. 1996. Evaluation of the relationship between land-use changes and groundwater quality in a water supply catchment, using GIS technology: The Gwelup wellfield, Western Australia. *Hydrogeology Journal* 4: 6–19.
- Gerritse, R.G., Barber, C. and Adney, J.A. 1990. The impact of residential areas on groundwater quality: Swan Coastal Plain, Western Australia. *Water Resources Series No. 3*. CSIRO Division of Water Resources, 26pp.
- Lantzke, N. 1997. Phosphorus and nitrate loss from horticulture on the Swan Coastal Plain. *Miscellaneous Publication 16/97, Agriculture Western Australia*, 38pp.
- Meisinger, J.J. and Randall, G.W. 1991. Estimating Nitrogen Budgets for Soil-Crop Systems. *In: Follett, R.F., Keeney, D.R. and Cruse R.M., eds., Managing Nitrogen for Groundwater Quality and Farm Profitability*. Soil Science Society of America.
- Nind, C. 1997. Economic instruments to manage groundwater pollution by pesticide leaching from vegetable growing areas on the Gnangara Mound in Perth, Western Australia. *Dissertation, Faculty of Agriculture, UWA*.
- Salama, R.B., Pollock, D. and Byrne, J. 1999. Experimental and modelling results of pesticide leaching in agricultural systems: Examples from Thailand, Malaysia and Australia. *Solutions and Innovations. Proceedings of International Conference on Diffuse Pollution, Perth, Western Australia, 16–20 May*.
- Salama, R.B., Pollock, D. and Byrne, J. 2001. Modelling pesticide and nutrient transport in the Gnangara Mound. *These Proceedings*.
- Sharma, M.L., Herne, D.E., Byrne, J.D.M. and Kin, P.G. 1995. Leaching of nutrients beneath urban lawns to an unconfined sandy aquifer. *CSIRO Division of Water Resources Report No. 95-12, 111pp*.

Regional Vulnerability to Pesticide Contamination in the Gngangara Mound under Different Management Scenarios

R.B. Salama, D.W. Pollock and J.D. Byrne¹

Abstract

The Attenuation Factor (AF) model was used to simulate the leaching potential for carbofuran for the soils of the Gngangara Mound to a depth of 100 cm under three different rates of recharge: 0.1, 0.3 and 0.6 cm/day. The LEACHP model was used to simulate four scenarios for the leaching of atrazine under different irrigation rates in pine plantations and horticultural areas. CMLS was also used to simulate travel time for atrazine to a depth of one metre. Two methods were used to upscale the modelling results: MS-VULPEST was used to upscale the AF and CMLS results; soil maps and GIS techniques were used to upscale the LEACHP results. The results showed that due to the high hydraulic conductivity of the Bassendean sands, the travel time of atrazine to reach a depth of one metre was approximately 59 days, but it was 173 days in some areas due to high organic carbon. In the Spearwood sands, the travel time was about 77–100 days. The LEACHP scenarios indicated that by applying high irrigation rates in the horticulture areas, 60–70 mg/m² of the pesticide would leach below the 80 cm layer. These results suggest that there is a potential for some pesticides to reach the groundwater aquifers, especially in the agricultural areas.

PESTICIDECONTAMINATION of shallow and deep groundwater has been recorded in many countries. It is reported that some 32 herbicides, 19 insecticides and two fungicides have been detected in groundwaters from various parts of the world (Vighi and Funari 1995). Several pesticides have been detected in groundwater from the Gngangara Mound, specifically atrazine and diazinon. However, their concentrations are well below the Australian National Health and Medical Research Council (NHMRC) guideline limits.

Groundwater vulnerability to pesticide contamination depends on several factors including physical, chemical and biological processes that determine the fate of each pesticide. The vulnerability is dependent on, and strongly affected by, spatial and temporal variations in these processes. Hydrogeomorphic Analysis of Regional Spatial Data (HARSD) methodology was used in this study as part of the overall scheme of reducing the uncertainty. HARSD partitions catchments into areas of similar hydrological and hydrogeological characteristics (Salama et al. 1997).

Vulnerability maps and vulnerability assessments are tools available to groundwater managers to define areas at risk from pollution and to develop groundwater management strategies. Groundwater vulnerability is defined as 'the tendency or likelihood for contaminants to reach a specified position in the groundwater system after introduction at some location above the uppermost aquifer' (National Research Council 1993). A vulnerability map is a graphical display or representation of the degree of vulnerability of an aquifer as a function of time and location. Geographic Information System (GIS) techniques are dynamic and represent various scenarios.

Methods

Soil hydraulic properties (size analysis, hydraulic conductivity, retentivity and organic content) were obtained from the results of 21 selected sites representing the major soil-types in the area under different management scenarios. Together with the

¹ CSIRO Land and Water, Private Bag No 5, PO Wembley, Western Australia 6913

regional soil maps, these were used to prepare the base maps for upscaling the modelling results.

Leaching potential of the pesticides were estimated using the results from applying several models: Hornsby Index (Hornsby 1992); AF Index (Rao and Alley 1993); CMLS (Nofziger et al. 1998); and LEACHP (Hutson and Wagenet 1992). Regional groundwater vulnerability maps that indicate the impact of leaching of pesticides under different management scenarios were prepared for the Gngangara Mound. Regional maps of pesticide leaching were also prepared using simple GIS techniques to upscale results from LEACHP modelling.

Soil and water mapping

A detailed soils map of the Gngangara Mound was collated from previous works by McArthur and Bettenay (1960) and McArthur and Bartle (1980). The physical and chemical characteristics of the soils were obtained from a detailed study of 21 sites in the Gngangara Mound. The sorption coefficients for the modelled pesticides with the different soils were derived in CSIRO Land and Water laboratories in Adelaide. A hydrogeomorphic map for distribution of recharge based on soils, geology, and attributes of topography was prepared from a digital elevation model prepared by the WALands Department.

A water-level map for the superficial aquifer of the Gngangara Mound was prepared using data obtained from the WAWaters and Rivers Commission SWRIS database. A depth-to-water map was prepared by subtracting the coverage of the surface elevation from the water-level map. The direction of groundwater flow was determined from the water-level map.

Herbicides in pine plantations

Establishment of pine plantations in the Gngangara Mound depends upon the use of herbicides such as triazines and glyphosate. The herbicides are applied once or twice per rotation at the rate of 0.5 kg/ha.

Transport of three herbicides (atrazine, simazine, and glyphosate) through the sandy soils to groundwater under the Gngangara Mound has been studied by Gerritse, Beltran and Hernandez (1996). Simazine, atrazine and degradation products of atrazine were moderately-to-strongly adsorbed to surface soils, with sorption coefficients >5 L/kg. Adsorption increased with increasing content of soil organic carbon, while adsorption in the subsoils was weak. Adsorption of glyphosate appeared to increase exponentially with oxides of iron and aluminium, and to decrease with increasing soil organic carbon. Glyphosate is also strongly adsorbed to the clay mineral kaolinite, which explained the strong adsorption measured in some of the sandy soils of the Gngangara Mound.

Pesticides in horticultural areas

In a field study of leaching and degradation of nine pesticides in the Karrakatta sand, Kookana, Di and Aylmore (1995) found that chlorpyrifos and chlorthal dimethyl are degraded to insignificant concentrations before reaching groundwater. In contrast, metalaxyl, linuron, and fenamiphos and its metabolites have much greater leaching potential. Due to much lower microbial population in the lower vadose zone, these pesticides may persist longer than expected and may present a contamination hazard to groundwater.

It was also found that behaviour of some of the degradation and transformation products of fenamiphos, which are toxic, differ markedly between subsurface and surface soils (Kookana, Phang and Aylmore 1997). Therefore, the degradation half-lives of pesticides based on surface soils (from current data bases) are unlikely to yield an adequate assessment of their environmental fate, especially movement through the soil profile to groundwater.

In urban areas around Perth, Gerritse, Barber and Adeney (1988) sampled 64 boreholes along a transect through the Bassendean sands and analysed these for aldrin, dieldrin, chlordane, and heptachlor. Generally the levels of the pesticides were found to be below detection limit; however, DDT, aldrin and chlordane were slightly higher in some samples. Most of the reported cases of pesticide contamination resulted from malpractices. For example, Appleyard (1995) reported that spray equipment washed in a backyard in suburban Perth resulted in contamination of groundwater with the nematicide fenamiphos and the herbicide atrazine.

Pesticide extraction

At the laboratory, core samples were cut into three equal lengths of 100 mm. The soil from each length was placed on a 30 x 30 cm alloy sheet and mixed thoroughly.

A soil sub-sample of about seven grams was sampled from each of the three mixed soil depths (0–100, 100–200 and 200–300 mm), and the soil placed into pre-weighed, labelled 16 x 125 mm pyrex vials with teflon lids. Care was taken to handle each soil sample using separate scoops made of aluminium to transfer the soil into the vials. Sub-samples for moisture content were also taken at the same time. The vials were then weighed, capped and recorded, as were the pre-weighed soil moisture content containers and soil.

Internal standard (25 ml) was then added to each of the vials, immediately followed by acetone/ether mixture (5 ml). A blank of the solvents was also taken

at this point. The vials were shaken vigorously for two minutes to mix the soil with the standard and the acetone/ether solution. The vials were placed into a sonic bath for ten minutes and left to stand for about 15 hours. The vials were sub-sampled using pasteur-pipettes to transfer 1 ml of the solution into 2 ml auto-analyser vials. The labelled vials were capped and placed into a freezer, ready for pesticide analysis.

Results

Pesticide analyses of soil samples collected from the strawberry and turf farms on separate days from three different depths for various pesticides are shown in Table 1.

Leaching of pesticides using CMLS and MS-VULPESTmodels

CMLS was used to simulate travel time for atrazine to a depth of one metre. The results show that due to the high hydraulic conductivity of the Bassendean sands, the travel time is about 59 days; but it takes approximately 173 days in some areas due to the high organic carbon. In the Spearwood Sands the travel time was about 77–100 days.

Soil maps of the Gngagara Mound were used together with the MS-VULPEST model (Zhou and Otto 1999) to study the vulnerability of the most commonly used pesticides on a regional scale using the attenuation factor index (AF). The AF index is

Table 1. Pesticide analyses in the strawberry and turf farms.

Depth of Sample (cm)	Pesticide ($\mu\text{g}/\text{kg}$)						
	Atrazine	Diazinon	Dimethoate	Endosulfan	Chlorpyrifos	Fenamiphos	Malathion
<i>Strawberry farm (18/09/97)</i>							
0–10	<1	<5	<10	<10	<5	<5	<5
10–20	<1	<5	<10	<10	<5	<5	<5
20–30	<1	<5	<10	<10	<5	<5	<5
<i>Turf farm (14/10/97)</i>							
0–10	<1	<5	<10	<10	<5	<5	<5
10–20	<1	<5	<10	<10	<5	<5	<5
20–30	<1	<5	<10	<10	<5	<5	<5

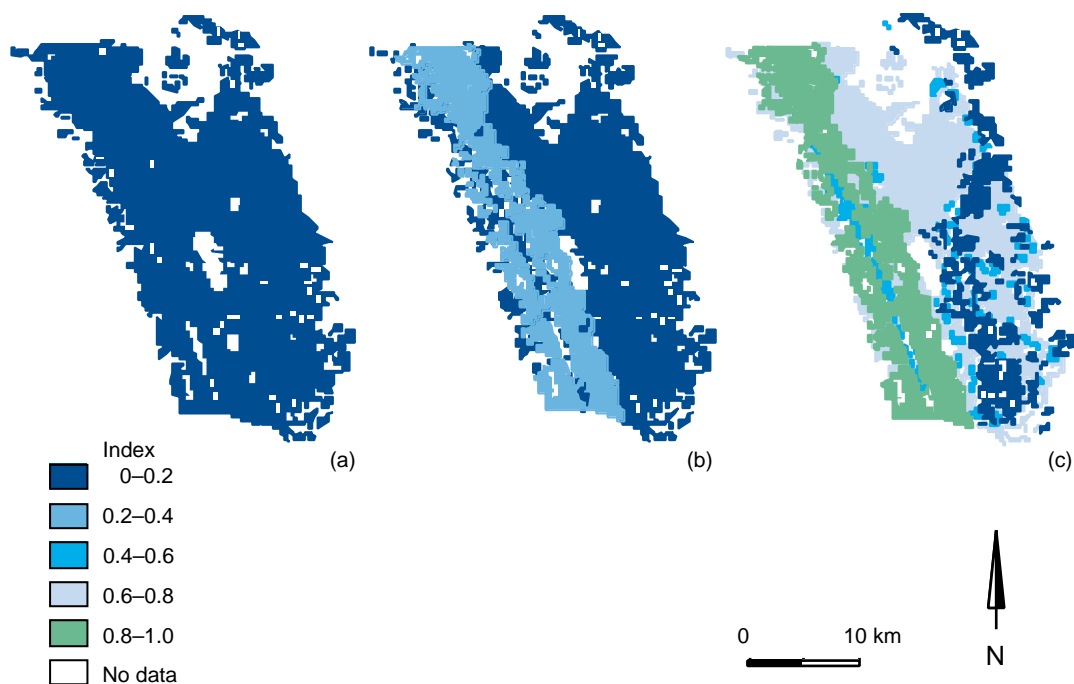

Figure 1. AF index of carbofuran to a depth of 100 cm and recharge rates of: (a) 0.1; (b) 0.3; (c) 0.6 cm/day.

equivalent to the fraction of the applied pesticide mass that is likely to leach past the chosen reference depth. The results are shown in Figure 1 and illustrate the regional risk of a pesticide (carbofuran, in this case) for the soils of the Gngangara Mound under three different recharge rates: 0.1, 0.3 and 0.6 cm/day.

Although the higher recharge rate indicates a higher AF index, the results also indicate that the soils have high filtering capacity and there is very small risk that high amounts of pesticide will leach below one metre. This is mainly due to the relatively high organic carbon content (1–4 per cent) in the top 15 cm of most soils in the area. The maps show the effect that different soils have on the AF index. The soils that are most vulnerable are the Karrakatta Yellow and Spearwood (Spearwood Dune System), and the least vulnerable are the Gavin and Joel (Bassendean Dune System). The AF indices for the other pesticides show that some, such as metalaxyl, gave slightly lower AF values than carbofuran; others, such as atrazine and metribuzin, were significantly lower.

Leaching of pesticides using LEACHPand GIS techniques

The LEACHP model was used to simulate the leaching of atrazine in the pine areas as well as in the horticulture areas. Modelling was carried out for the Bassendean as well as for the Spearwood sands.

Several simulations were carried out to ascertain the effect of the different management scenarios on the leaching of the pesticides.

Scenario 1:

irrigation water applied at the recommended rate of 100 per cent of pan evaporation

Scenario 2:

irrigation applied by the farmers (11 mm/day)

Scenario 3:

irrigation water with double the organic carbon of Scenario 1

Scenario 4:

irrigation water with double the organic carbon of Scenario 2.

The amount of pesticide applied in all four scenarios was 100 mg/m². The results (Figure 2) showed that applying Scenario 1 with the optimum irrigation rates will increase the travel time of the pesticide and will retain a higher proportion of the pesticide in the top layer, thus giving it more chance to degrade. The results also showed that Ky soils have a higher filtration capacity to all the modelled pesticides followed by the KIs while the Sp has the lowest filtration capacity. In the pines, atrazine leaching past the 80 cm layer was less than 10 mg/m² in all four scenarios as no irrigation was applied to the pines.

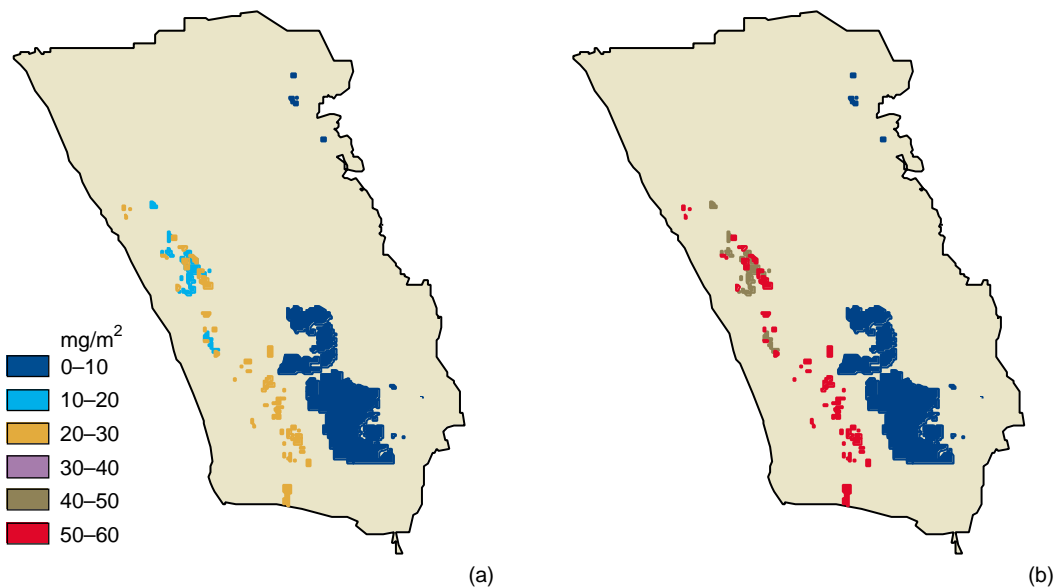

Figures 2(a–d). Atrazine leaching below 80 cm for LEACHP Scenarios 1–4, respectively.

In the horticulture areas on the Spearwood sands, in Scenario 1, more leaching of pesticides took place due to the application of irrigation water, mostly 30–40 mg/m². In some areas in the Ky soils, the leaching was lower and ranged between 10 and 20 mg/m² (Figure 2(a)). In Scenario 2, where higher irrigation rates were used, leaching was 60–70 mg/m² with the Ky showing slightly lower values of 50–60 mg/m² (Figure 2(b)). Adding organic carbon reduced the flux in the horticultural areas to below 20 mg/m² in Scenario 3 (Figure 2(c)), but even with double organic carbon, if the irrigation rate is increased to 11 mm, the higher rates of water infiltration will reduce the filtering capacity of the soils and more leaching will take place (Figure 2(d)).

Conclusions

The results of this study showed that only a small number of pesticides have the potential to contaminate the Gngangara Mound aquifer. This conforms with the conclusions of Salama, Pollock and Byrne (2001). The results also indicate that the most effective management to reduce nutrients leaching is by reducing fertiliser application rates and applying the optimum irrigation rates. The Karrakatta limestone sand appears to be the best soil to retain most of the nutrients.

Often managers and farmers do not have many choices for the selection of the most useful pesticide that will also have the shortest half-life and highest sorption coefficient. They will in some cases be influenced by trade names, advertising and prices. In most cases, in order to guarantee protection of their crop, they will use more than one pesticide that might have the same effect. It seems that the long-term solution to the pollution problem is the application of an integrated pest management practice. This includes using:

- minimum amounts of pesticides
- biological controls
- netting systems
- soil amendments to increase the organic carbon content
- better irrigation practices.

Nevertheless, due to the sandy nature of the Gngangara Mound soils and the fact that between 30 and 50 per cent of the irrigation water reaches the aquifer, the small number of pesticides that leach to the aquifer form a real threat to this vital water source.

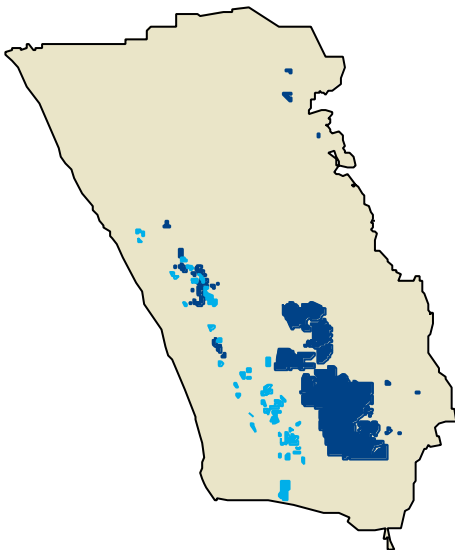

(c)

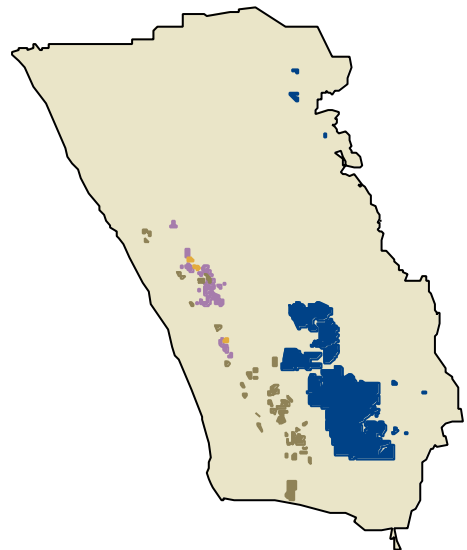

(d)

References

- Appleyard, S.J. 1995. Investigation of groundwater contamination by fenamiphos and atrazine in a residential area: source and distribution of contamination. *Groundwater Monitoring and Remediation* 15(4): 110–113.
- Gerritse, R.G., Barber, C. and Adeney, J. 1988. The effects of urbanisation on the quality of groundwater in Bassendean Sands, CSIRO Division of Water Resources Report, 52pp.
- Gerritse, R.G., Beltran, J. and Hernandez, F. 1996. Adsorption of atrazine, simazine, and glyphosate in soils of the Gngangara Mound, Western Australia. *Australian Journal of Soil Research*, 34: 599–607.
- Hornsby, A.G. 1992. Site-specific pesticide recommendations: the final step in environmental impact prevention. *Weed Technology* 6: 736–742.
- Hutson, J.L. and Wagenet, R.J. 1992. LEACHM: Leaching Estimation and Chemistry Model. Version 3. Cornell University, New York.
- Kookana, R.S., Di, H.J. and Aylmore, L.A.G. 1995. A field study of leaching and degradation of nine pesticides in a sandy soil. *Australian Journal of Soil Research* 33: 1019–1030.
- Kookana, R.S., Phang, C. and Aylmore, L.A.G. 1997. Transformation and degradation of fenamiphos nematocide and its metabolites in soils. *Australian Journal of Soil Research*, 35: 753–761.
- McArthur, W.M. and Bartle, G.A. 1980. Landforms and soils as an aid to urban planning in the Perth metropolitan Northwest Corridor, Western Australia. CSIRO Land Resources Management Series No. 5.
- McArthur, W.M. and Bettenay, E. 1960. The development and distribution of the soils of the Swan Coastal Plain, Western Australia. CSIRO Soil Publication No. 16.
- National Research Council 1993. Groundwater vulnerability assessment: Predicting relative contamination under conditions of uncertainty. Committee on Techniques for Assessing Groundwater Vulnerability, Water Science and Technology Board, Commission on Geosciences, Environment and Resources, US National Research Council.
- Nofziger, D.L., Chen, J.S., Wu, J., Ma, F. and Hornsby, A.G. 1998. The chemical movement in layered soils. Model for batch processing. Division of Agricultural Sciences and Natural Resources, Oklahoma State University.
- Rao, P.S.C. and Alley, W. M. 1993. Pesticides. *In*: Alley, W.M., ed., *Regional Groundwater Quality*. VNR, New York, 345–382.
- Salama, R.B., Hatton, T.J., Elder G.M., Ye, L. and Dowling, T. 1997. Hydrogeological characterisation of catchments using Hydrogeomorphic Analysis of Regional Spatial Data (HARSD): Characterisation of Axe Creek Catchment, Victoria, Australia. *In*: Taniguchi, M., ed., *Subsurface Hydrological Responses to Land Cover and Land Use Change*. Kluwer Academic Publishers, Boston: 153–166.
- Salama, R.B., Pollock, D.W. and Byrne, J.D. 2001. Modelling pesticide and nutrient transport in the Gngangara Mound. *These Proceedings*.
- Vighi, M. and Funari, E., eds., 1995. *Pesticide risk in groundwater*. CRC Lewis Publishers, London.
- Zhou, F. and Otto, C. 1999. MS-VULPEST User Manual. Multi-scale groundwater vulnerability assessment for pesticide contamination model. CSIRO Land and Water Report (in press).



T h a i l a n d

THE RATAPHUM WATERSHED, an important part of the Songkhla Lake Basin in the south of the country, was the location of the Thai project site. In the upper parts of the watershed, rubber plantations dominate agricultural activity; there is also some small-scale tropical fruit production. Rice is produced in the flatter lowlands; but near the Lake intensive vegetable production is predominant. The intensive production of vegetables, often five crops each year, requires regular inputs of pesticide and fertiliser. Most villagers rely on shallow wells for their drinking water supplies as well as for supplementary irrigation, so protection of the groundwater is a major concern in this area.

Soils, Landforms and Landuse in the Agroecosystems of Rataphum Watershed Area, and the Risk of Chemical Pollution

N. Panapitukul and W. Chatupote¹

Abstract

Analysis of the physical and chemical characteristics of the top one metre of soil was carried out at six sites representing the major soil units under the different landforms and landuses in the Rataphum watershed. The results show that in low areas, poorly-drained hydromorphic gley and low humic gley soils have low leaching potential due to low hydraulic conductivity throughout the profile. Due to the combination of high organic matter and medium clay content, transportation of chemicals to the groundwater was retarded. However, the heavy input of chemicals may induce higher contamination at local spots. In the lowland coastal plain, groundwater podsolc soils are widely used for vegetable production. This well drained sandy-loam to loamy sand has medium hydraulic conductivity in the top 25 cm and low conductivity below this point. The low hydraulic conductivity and lower input of chemicals may decrease the risk of contamination to groundwater. Low humic gley soil in low terraces derived from old alluvium has higher hydraulic conductivity and lower clay content than soils derived from recent riverine deposits. The former are used for rubber plantations, where contamination from chemical fertilisers and herbicides may occur at higher rates. In the foothills, red-yellow podsolc soils contain a higher percentage of gravel at the top, while the clay content increases with depth. Due to the higher hydraulic conductivity in the top 50 cm and low organic matter, the risk of leaching of chemicals is higher.

SOILS PLAY A KEY ROLE in determining the fate of pesticides in the environment. Pesticide sorption in soils is dependent also on type of pesticide, type and amount of organic matter, and type of clay and other minerals involved in the pesticide adsorption-desorption processes. Soil physical characteristics, hydraulic properties, soil-water retention and soil-type contribute to the leaching and diffusion of a pesticide through the soil profile. Land management practices such as tillage and manure application induce change to some chemical and physical characteristics of the soil, which affect pesticide contamination in the environment. Rataphum watershed is a sub-watershed of the Songkhla Lake Basin and was selected as the representative area for studying agrochemical pollution.

The Environment

Topography

Songkhla Lake Basin

The basin consists of three main topographic units (John Taylor & Sons 1985). A narrow range of mountains to the west and south of the Basin is covered with native forest. Parts of the foothills and terraces are used for growing tropical fruits, but the majority is used for rubber plantation. The broad plains to the east of the Basin which connect to Songkhla Lake are used for paddy and vegetable production. The major water resources for more than 75 per cent of

¹ Faculty of Natural Resources, Prince of Songkla University, Thailand

the population of the area are private shallow wells dug into a shallow aquifer. Agrochemicals are widely used in the intensive cropping systems of vegetable and fruit production in the area. Groundwater is at a shallow depth and used for irrigation. In these areas the water resources are at risk of agrochemical contamination.

Rataphum watershed

Rataphum watershed is a sub-watershed representative of the western part of the Songkhla Lake Basin. A narrow range of granite mountains to the west and south of the Basin still supports native forest. Parts of the foothills and terraces are used for growing tropical fruits, but most is used for rubber plantations. The broad plains of recent alluvial deposits, gravel sand, silt clay and beach sand are used for paddy and vegetable production. The terrace deposits, gravel, sand, silt and laterite support mainly rubber plantations. Humic gley and groundwater podsols are the main soil types of the coastal plain, and the low humic gley and grey podsolic soils are the main types of the low terrace. At the foothills,

red-yellow podsolic soils derived from quartzitic sandstone and shale or granite are the main types.

Climate

The Songkhla Lake Basin has a tropical monsoon climate (Meteorological Department, 1994). North-east and southwest monsoons are active in October–March and May–September, respectively. The climate shows distinct seasonal patterns of rainfall. Heavy rainfall occurs during the northeast monsoon period, with a major peak in October–December. The average rainfall over the Songkhla Lake Basin is approximately 1880 mm pa, varying between 1600 and 2400 mm. About 60 per cent of the annual rainfall occurs in a short period between October and December, resulting in floods in the northeast monsoon season and a water deficit during the rest of the year.

Geomorphology

A narrow range of mountains to the west and south of the watershed slopes eastward through the foothills and flood plain to Songkhla Lake. The landform consists of plains, foothills, hills and mountains, and a lake system and inland wetlands (Figure 1).

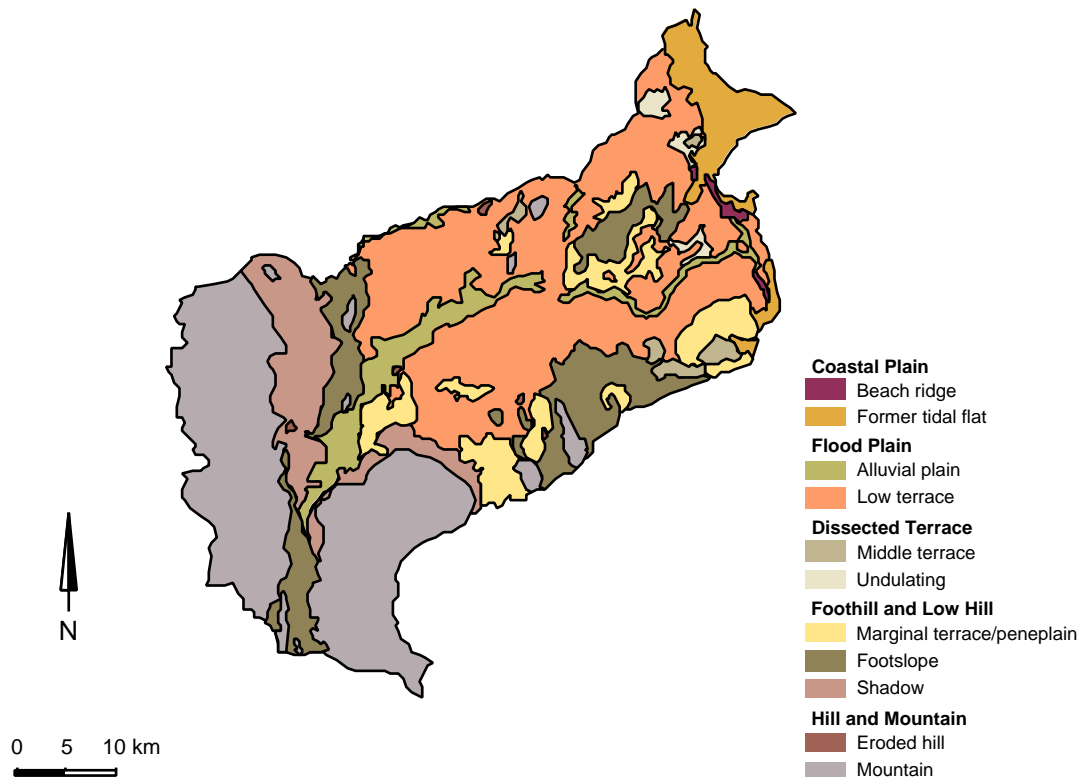

Figure 1. Rataphum landforms.

Plains

The coastal plain was formed by marine deposits of clay and low sand ridges as a consequence of a relative regression in sea level. During pauses in a period of movement, clay was deposited in shallow seas, and a sand ridge was formed along the coastal front.

The flood plains are of fluvial origin and occur in the east of the watershed. Regular deposits of clays and silts brought down by rivers led to shoals and shallows forming offshore. The marine clay deposits consist of very soft clay and silt covered by recent flood deposits.

Foothills

The footslope and terraces form a narrow band along the east side of the mountain range, with slopes of 5–25 percent. They are generally composed of gravel, sands, silts and laterite. The high plain in the west, with altitudes of 80–120 m above sea-level, forms the transition between the hills and the low plain. It is a peneplain of Mesozoic sedimentary rock with terraces of Pleistocene deposits.

Hills and mountains

The hills are scattered throughout the high land of the area. The mountains at the boundary of the project area in the west form a land crest of uplifted rocks with steep slopes. The mountains (average height 500 m above sea-level) are formed by erosion-resistant granite.

Lake system and inland wetlands

These include the present lake and fringing swamps and marshes. The wetland areas are formed by silting caused by recent inundation, and thus consist of very soft silt and clay.

Soils

The major soil units within the Songkhla Lake Basin are: humic gleys (20 per cent of the total area), hydromorphic alluvial (15 per cent), podsol (16 per cent), humic gley/podsol association (21 per cent), lithosol/podsol association (7 per cent), and slope complex soils (17 per cent) (Department of Land Development 1981). Characteristics of the soils within the Rataphum watershed itself are shown in Table 1, and their distribution is shown in Figure 2.

Table 1. Characteristics of soils in Rataphum watershed.

Soil Unit	Major Great Soil Group	Slope (%)	Landuse	Examples of Texture & Profile	Drainage	Groundwater Level	Organic Carbon (%)
6	low humic gley	0–1	rice and vegetables	Loam or silt-loam or clay-loam over silty clay or clay with plinthite of more than 50% in any sub-horizon with 1.25 m.	poor	saturated for 4–5 months of the year.	medium (1.75)
17	hydromorphic alluvial	0–1	rice and vegetables	Sandy-loam over loam or sandy-clay-loam which occurs at a depth of 60–85 cm, accompanied with plinthite that forms a continuous phase or constitutes more than half of the matrix of some sub-horizon.	poor	saturated for 3–4 months of the year	low (0.85)
23	groundwater podsol	0–1	rice and vegetables	Sandy-clay-loam over sandy-loam over loamy sand or sand accompanied by soft iron concretion or iron pipe	moderately poor	saturated for 3–4 months in rainy season	moderately low (1.4)
34	grey or red-yellow podsol	2–5	rubber and fruit	Sandy-loam over medium to coarse sandy-loam throughout.	moderately good	below 1 m throughout the year	medium (1.8)
45	red-yellow podsol	6–12	rubber and fruit	Sandy-loam or loam over very gravelly loam, very gravelly clay-loam or very gravelly sandy-clay-loam or rock.	good	below 1 m throughout the year	moderately low (1.4)

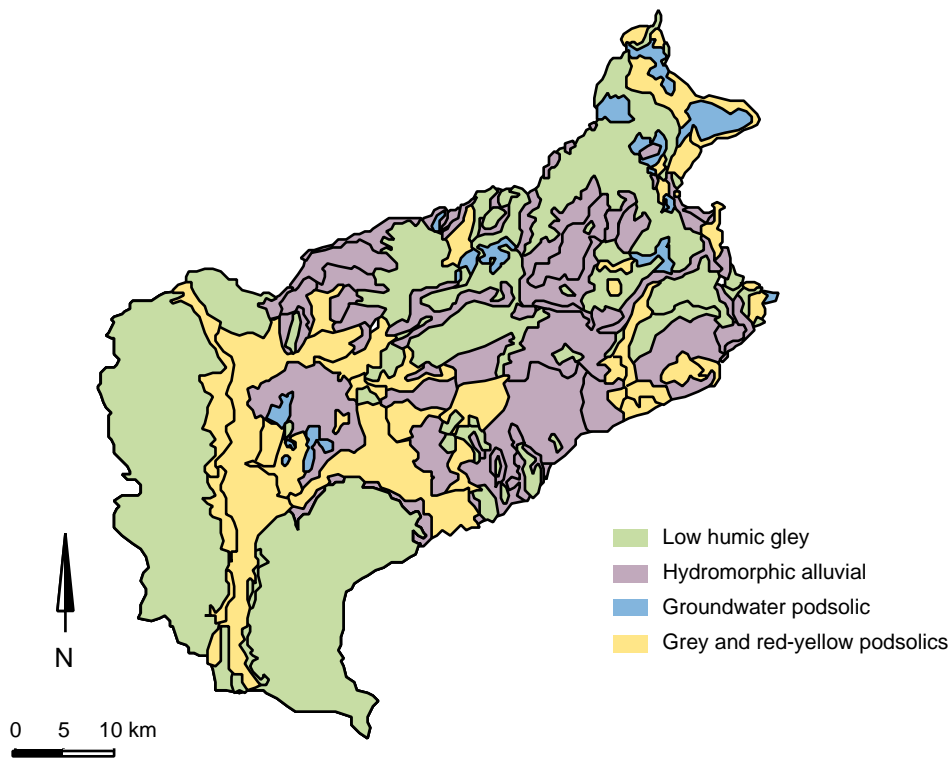

Figure 2. Major Rataphum soils.

Humic gleys

The gleys are the main old flood-plain or lowland soils found throughout the rice-growing areas and swampy land. They are sandy-loams to silty clays. They are moderately suitable for rice production and those few field crops which can tolerate the heavy blocky structure of the subsoil when dry. Poor drainage and low phosphorous and potassium levels are their main limitations.

Hydromorphic alluvials

The alluvials are mainly on inland wetlands and coastal plains of recently-deposited beach soils, with the better drained areas usable for rice. Poor drainage and flooding, and acid sulphate and saline salt content in some areas, are the main limitations. This soil-type is likely to need substantial applications of N and P fertiliser to achieve good yields of rice and dry-season crops.

Podsols

These are located on the foothills and dissected terraces along the western and southern boundaries of the basin. They are used mainly for rubber plantation. Base saturation and cation exchange capacity are

usually low, as are the nutrients P and K, resulting in low fertility which is the main limitation for other crops.

Slope complex soils

These are shallow recent soils on the upper foothills and mountainous areas. They are well drained with poor fertility and high erosion potential if cleared of trees. They are moderately suitable for rubber plantation.

Landuse

The landuse activities in Rataphum watershed are shown in Figure 3.

Rubber plantations, mostly small-holdings, are the main activity in the area. They are located in the uplands. Adoption of high-yielding clones (i.e. monoculture) and intensive agricultural techniques has been widespread which places the plantations at risk of disease. The foothills also have fruit orchards, especially in areas with reliable water resources. The fruits harvested in the area are rambutan, mangosteen, durian and longon. There appears to be a trend towards land being progressively diverted from rubber production to fruit.

The lowland area is primarily used for rice production, with most rice cultivation producing only

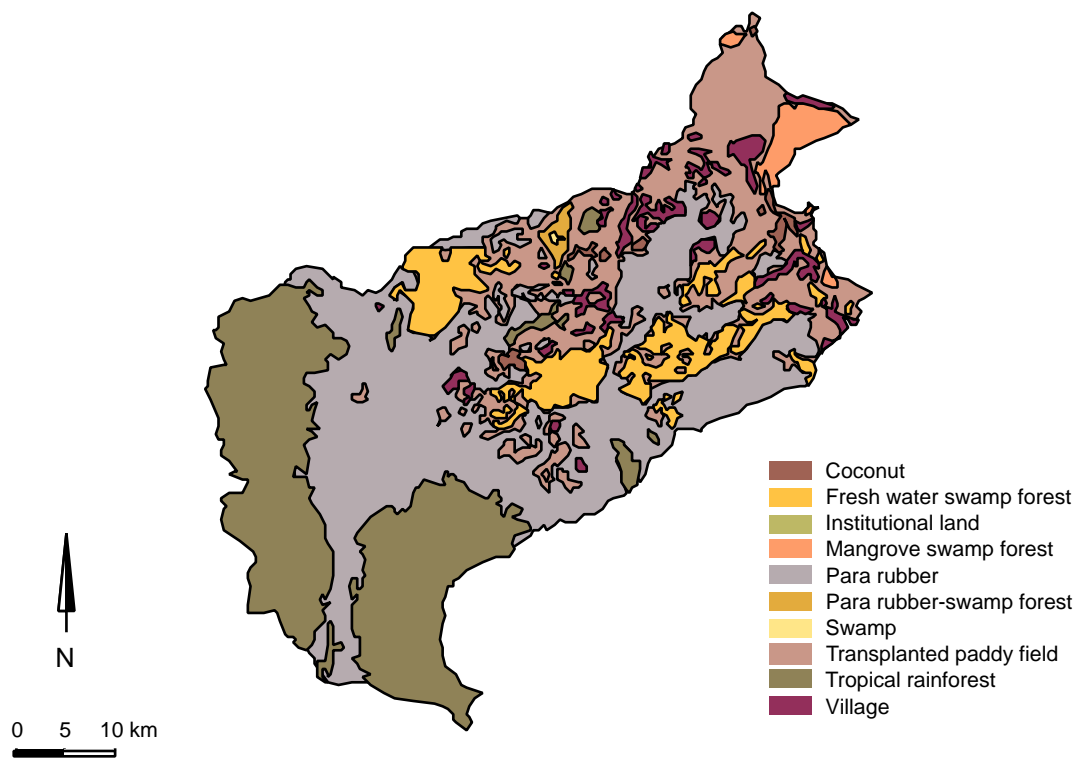

Figure 3. Rataphum landuses.

one crop per year. Rice cropping intensity has declined in the last decade due to irregular water supply and problems with controlling waterflow. Low market prices for rice has led to the adoption of less labour-intensive techniques and smaller plot sizes.

Changes from rice crops to raised-bed practices to grow perennial fruit and vegetable crops have increased rapidly in recent years. The common vegetables grown are kale (*Brassica alboglabra*), chaisim (*B. pekinensis*) and petsai or Chinese cabbage (*B. chinensis*), which have a growing period of about 30 days. In order to grow more crops per year, most farmers use vegetable varieties with a short maturation time. Cropping in such a large area with several cropping cycles results in intensive management in terms of labour, pesticides, herbicides, fertilisers and irrigation.

Methodology

To study the soil characteristics contributing to leaching of pesticides and chemicals in each landform and landuse, five major soil units were selected to represent different soil-types in different landforms and landuses (Figure 4).

Soil units numbers 6, 17 and 23 in the lowlands (under vegetables) and 34 and 45 (under fruit and rubber) were selected for study. These included one site for soil No 6 (Bp4), soil No 17 (Bp1), soil No 23 (Bp8), soil No 45 (Kp4), and two sites for soil No 34 (Tp3 and Tp3a). Soils at the sites selected were sampled and divided into horizons (soil sampling sites are shown in Figure 4).

Different sets of undisturbed soil samples were taken using sampling rings (100 cm² volume and 53 mm diameter) for the analysis of saturated hydraulic conductivity and bulk density. The samples were taken by driving the ring holder into the soil surface in the borehole at different depths. The method of soil collection employed in this study may have caused the compaction of soil at the lower layers in the collecting tube in each sampling exercise. Soil samples are usually taken on the surface in profile, not in a borehole.

The disturbed soil samples were used for particle size distribution, organic matter, pH and soil-moisture retention analysis. Particle size distribution was measured by the hydrometer method. Organic matter,

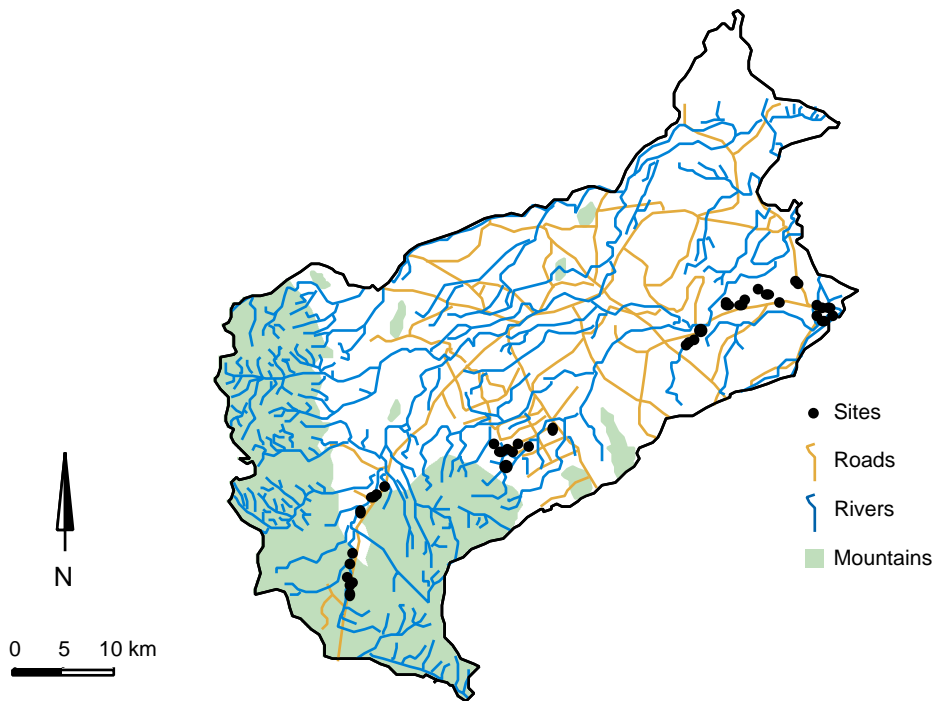

Figure 4. Sites of soil samples.

pH, and soil moisture retention were measured by standard methods. Saturated hydraulic conductivity was measured by the constant and falling head methods (American Society of Agronomy 1986a; 1986b)

Results

Soil physical and chemical characteristics of selected soil units and landuse are presented in Tables 2–3.

Low humic gley soils (Soil Unit 6)

Site Bp4 is located in the low terrace area approximately five metres above sea-level and the slope is 0–1 per cent. The poorly-drained soil is formed from old alluvium deposits. The loams to clay-loams and sandy-loams are intensively used for commercial vegetable production.

Hydraulic conductivity is very low throughout the profile (0.001–0.3 cm/day). Organic matter is medium in the top 30 cm (1.28 per cent) and decreases with depth (0.24–0.19 per cent), while pH is mildly alkaline at the top and very strongly acidic beyond this depth. The soil-water capacity is 8–16 per cent by volume. Restriction of drainage occurs below 25 cm due to the presence of clay and the low hydraulic conductivity. The watertable in this area is below one

metre during the dry season and rises near the surface during the monsoon season. Water fluctuations are between 0 and 220 cm.

The low risk of chemical contamination in groundwater in this type of soil is due to the medium amount of organic carbon at the top, high clay content at 25–60 cm (34.18 per cent) and low hydraulic conductivity. Intensive inputs of chemicals and bad management practices increase the risk to the area.

Hydromorphic alluvials (Soil Unit 17)

Site Bp1 is located in the low terrace area. Elevation is 8–10 metres above sea-level and the slope is 0–1 per cent. This poorly drained soil is formed from hydromorphic alluvium deposits. The loams to sandy-loams are intensively used for commercial vegetable production.

The hydraulic conductivity is very low throughout the profile (0.001–0.003 cm/day). Organic matter is moderately high in the top 30 cm (1.5 per cent) and decreases with depth (0.16–0.06 per cent); pH is mildly alkaline in the top 30 cm, and very strongly acidic below this depth.

Soil-water capacity varies between 10 and 15 per cent by volume. Restriction of drainage occurs below 15 cm due to the low hydraulic conductivity. The

Table 2. Soil characteristics.

Site	Soil Unit	Landuse	Depth (cm)	Hydraulic conductivity (cm/day)	Field Bulk Density (g/cm ³)	Porosity E 1-(bd/2.65)	pH	Organic Carbon	Sand (%)	Silt (%)	Clay (%)	Texture
Bp4	6	Intensive vegetables	0–25	0.004	1.61	0.39	7.47	1.28	51.05	36.43	12.52	loam
			25–60	0.029	1.55	0.42	4.44	0.24	34.76	31.06	34.18	clay-loam
			60–125	0.001	1.81	0.32	4.13	0.01	69.06	19.64	11.31	sandy-loam
			125–140	0.031	1.58	0.40	4.06	0.02	72.25	14.27	13.48	sandy-loam
Bp1	17	Intensive vegetables	0–15	0.003	1.73	0.35	7.60	1.49	43.38	38.35	18.27	loam
			15–30	0.001	1.82	0.31	7.37	1.50	42.05	44.38	13.57	loam
			50–60	0.002	1.61	0.39	4.17	0.16	41.61	25.48	32.91	clay-loam
			80–145	0.002	1.85	0.30	4.24	0.06	55.54	31.03	13.43	sandy-loam
Bp8	23	Extensive vegetables	0–25	248	1.82	0.31	5.55	0.49	67.22	27.42	5.36	sandy-loam
			25–65	0.035	1.56	0.41	5.75	0.26	49.23	41.30	9.48	loam
			65–80	90	1.60	0.40	4.37	0.04	79.73	15.42	4.85	loamy sand
			80–120	84	1.79	0.32	4.03	0.01	83.80	12.96	3.24	loamy sand
			120	0.503	1.71	0.35	4.12	0.01	55.74	33.72	10.54	sandy-loam
Tp3	34	Rubber plantations	0–15	136	1.68	0.37	4.34	1.12	72.25	25.04	2.72	sandy-loam
			15–50	33	1.74	0.34	4.30	0.38	77.08	19.57	3.35	loamy sand
			50–100	0.015	1.78	0.33	4.80	0.06	76.44	11.50	12.06	sandy-loam
			100–125	46	1.59	0.40	4.91	0.06	68.40	11.87	19.74	sandy-loam
			125	868	1.53	0.42	4.91	0.05	58.87	13.91	27.22	sandy clay-loam
Tp3a	34	Rubber plantations	0–50	4	1.17	0.56	4.55	1.27	7.82	54.53	37.66	silty clay-loam
			50–130	0.001	1.28	0.52	4.55	0.35	9.05	38.53	52.42	clay
Kp4	45	Fruit trees	0–10	422	1.60	0.40	5.02	0.49	64.81	27.25	7.94	sandy-loam
			10–20	134	1.54	0.42	4.60	0.35	62.24	24.85	12.91	sandy-loam
			20–40	1479	1.70	0.36	4.78	0.27	56.25	21.94	21.81	sandy clay-loam
			40–75	0.004	1.70	0.36	4.72	0.19	54.27	21.75	23.98	sandy clay-loam
			75–90	17	1.61	0.39	4.70	0.17	48.90	28.02	23.08	loam
			95–145	0.003	1.68	0.37	4.51	0.15	45.76	28.57	25.67	loam

water table in this area is below 1.5 m during the dry season and rises to near 40 cm during the monsoon season. The water fluctuations are between 40 and 220 cm. The low risk of chemical contamination in groundwater in this type of soil is due to the high organic carbon, high clay content in 50–60 cm (32.91 per cent) and low hydraulic conductivity. Intensive inputs of chemicals and bad management practices are likely to increase the risk of contamination in the area.

Groundwater podsolics (Soil Unit 23)

Site Bp8 is located on the coastal plain. Elevation is only five metres above sea-level and the slope is 0–1 per cent. This moderately well-drained soil was formed from recent marine deposits. The sandy-loams to loamy-sands are extensively used for home vegetable gardens and commercial vegetable production.

The hydraulic conductivity is usually low to very low with higher values at the top (249 cm/day) and with low horizons between 25–65 cm (0.035 cm/day) and below 120 cms (0.503 cm/day). Organic matter is

very low throughout the soil profile and decreases with depth, while pH is strongly to very strongly acidic.

Soil-water capacity is 6–15 per cent by volume. Restriction of drainage occurs below 45 cm due to the presence of clay and the low hydraulic conductivity. Few medium and coarse iron pipes occur below 65 cm from the soil surface. The water table in this area is below 1.5 m during the dry season and rises near the surface during the monsoon season. Water fluctuations between 10 and 220 cm. The risk of chemical contamination in groundwater in this type of soil is due to the low clay content of the top 25 cm, the low organic carbon, the above average inputs of chemicals, and bad management practices.

Grey and red-yellow podsolics

Site Tp3 (Soil Unit 34)

This site is about 60 metres above sea-level and the slope is 2–5 per cent. The well-drained soil is formed from old alluvium deposits. The sandy-loams are used for rubber plantations.

The hydraulic conductivity is usually medium (33–46 cm/day) with higher values at the top (136 cm/day) and at 125 cm depth (867 cm/day). The clay content increases with depth (2.7–27.2 per cent). Organic matter is low throughout the soil profile and decreases with depth, while pH is slightly acidic to strongly acidic. The soil-water capacity varies from 6 per cent to 24 per cent by volume. Restriction of drainage occurs below 75 cm due to the low hydraulic conductivity. The watertable in this area is below two metres during the dry season and rises near the surface during the monsoon season. Water fluctuations are between 0.1 and 5 m.

Risk of chemical contamination in groundwater in this type of soil is due to the low organic carbon and high hydraulic conductivity.

Site Tp3a (Soil Unit 34)

This site is about 60 metres above sea-level and the slope is 1–2 per cent. The poorly-drained soil is formed from recent riverine deposits. The loamy to clay soils are used for rubber plantations.

Hydraulic conductivity is usually low throughout the profile. The clay content increases with depth (37.7–52.4 per cent). Organic matter is moderately low in the top 50 cm and decreases with depth, while pH is strongly acidic. Soil-water capacity is 48–52 per cent by volume. Restriction of drainage occurs below 50 cm of the soil surface due to the low hydraulic conductivity.

The low risk of chemical contamination in groundwater in this type of soil is due to the high clay content and low hydraulic conductivity.

Site Kp4 (Soil Unit 45)

This site is about 80 metres above sea-level and the slope is 6–10 per cent. The well-drained soil is formed from residuum and colluvium from sandstone. The sandy-loams are used for fruit plantations.

Hydraulic conductivity is usually high (422–1479 cm/day) in the top 40 cm, and low (0.004–17.0 cm/day) below this. Clay content increases with depth (7.9–45.5 per cent). Organic matter is low throughout the soil profile and decreases with depth, while pH is

Table 3. Soil-water retention.

Site	Soil Unit	Landuse	Depth (cm)	Saturated (0.0 KPa)		Field Capacity (-300 Kpa)		WiltingPoint (-1500 KPa)		Bulk Density (g/cm ³)		Available Moisture (Volumetric)
				Gravimetric	Volumetric	Gravimetric	Volumetric	Gravimetric	Volumetric	Field	Lab	
Bp4	6	Intensive vegetables	0–25	0.26	0.42	0.16	0.28	0.07	0.12	1.61	1.52	0.16
			25–60	0.33	0.51	0.22	0.36	0.15	0.23	1.55	1.47	0.13
			60–125	0.27	0.49	0.11	0.20	0.05	0.09	1.81	1.65	0.11
			125–140	0.34	0.55	0.11	0.18	0.07	0.11	1.58	1.58	0.08
Bp1	17	Intensive vegetables	0–15	0.33	0.57	0.17	0.30	0.09	0.15	1.73	1.53	0.15
			15–30	0.32	0.59	0.13	0.24	0.07	0.13	1.82	1.51	0.12
			50–60	0.39	0.64	0.22	0.36	0.14	0.24	1.61	1.43	0.13
			80–145	0.28	0.52	0.11	0.21	0.05	0.10	1.85	1.63	0.10
Bp8	23	Extensive vegetables	0–25	0.28	0.45	0.16	0.26	0.03	0.05	1.82	1.82	0.21
			25–65	0.35	0.58	0.11	0.19	0.04	0.06	1.56	1.46	0.13
			65–80	0.25	0.40	0.10	0.16	0.01	0.02	1.60	1.06	0.13
			80–120	0.26	0.41	0.06	0.10	0.02	0.04	1.79	1.60	0.06
			120	0.30	0.53	0.13	0.23	0.04	0.08	1.71	1.56	0.15
Tp3	34	Rubber plantations	0–15	0.28	0.45	0.19	0.31	0.04	0.06	1.68	1.68	0.24
			15–50	0.28	0.48	0.08	0.14	0.03	0.05	1.74	1.68	0.09
			50–100	0.24	0.47	0.08	0.15	0.03	0.07	1.78	1.73	0.08
			100–125	0.32	0.58	0.12	0.22	0.08	0.15	1.59	1.54	0.07
			125	0.38	0.59	0.15	0.24	0.12	0.18	1.53	1.40	0.06
Tp3a	34	Rubber plantations	0–50	0.58	0.68	0.20	0.26	0.11	0.14	1.17	1.08	0.12
			0–130	0.58	0.75	0.23	0.33	0.13	0.18	1.28	1.21	0.15
Kp4	45	Fruit trees	0–10	0.32	0.52	0.18	0.28	0.05	0.08	1.60	1.54	0.20
			10–20	0.32	0.54	0.15	0.25	0.05	0.09	1.54	1.54	0.16
			20–40	0.31	0.54	0.18	0.31	0.10	0.18	1.70	1.65	0.13
			40–75	0.31	0.56	0.19	0.34	0.09	0.17	1.70	1.65	0.18
			75–90	0.49	0.84	0.18	0.31	0.09	0.16	1.61	1.43	0.15
			95–145	0.49	0.83	0.20	0.32	0.16	0.26	1.68	1.43	0.07

slightly acidic. Soil-water capacity is 33–37 per cent by volume. Restriction of drainage occurs below 50 cm due to the low hydraulic conductivity. The watertable in this area is below 1.8 m during the dry season, and rises to 1 m during the monsoon season. Water fluctuations are between one and three metres.

The risk of chemical contamination in groundwater in this type of soil can be due to the high hydraulic conductivity in the top 40 cm. Due to the high clay content and low hydraulic conductivity below this point, transportation of chemicals to the groundwater is retarded due to the high filtration capacity.

Conclusions

The risk of chemical contamination in groundwater is dependent on landform, landuse and soil characteristics (Pipithsagchan et al. 1994).

In lowland areas, poorly-drained hydromorphic and low humic gley soils have low leaching potential due to low hydraulic conductivity throughout the profile. High organic matter and medium clay content cause high filtration capacity which retards transportation of chemicals to groundwater. However, heavy input of chemicals may induce higher contamination at local spots. In the lowland coastal plain, groundwater podsolc soils are extensively used for vegetable production. This sandy-loam to loamy-sand soil has medium hydraulic conductivity in the top 25 cm of the soil surface and lower beyond this depth. The low hydraulic conductivity and lower input of chemicals is likely to decrease the risk of contamination to groundwater.

Low humic gley soils in the low terraces are used for rubber plantations. They are derived from old alluvium and have higher hydraulic conductivity and lower clay content than that of soils derived from recent riverine deposits; contamination from chemical fertilisers and herbicides is likely to occur at higher rates. In the foothills, red-yellow podsolc soils contain a higher percentage of gravel at the top while the clay content increases with depth; due to the higher hydraulic conductivity and low organic matter in the top 50 cm, the risk of leaching of chemicals is higher than below this point.

The risk of chemical contamination in soils and groundwater assessed from landform, landuse and soil characteristics provides useful baseline information. Detailed studies of rainfall patterns and water level fluctuations in each area together with landuse would improve such assessment.

References

- American Society of Agronomy 1986a. Methods of Soil Analysis. Chemical and Microbiological Properties. 2nd edition, Number 9 (Part 2) in the series Agronomy. American Society of Agronomy, Inc., Soil Science Society of America, Inc. Madison, Wisconsin, USA.
- American Society of Agronomy 1986b. Methods of Soil Analysis. Physical and Mineralogical Methods. 2nd edition, Number 9 (Part 1) in the series Agronomy. American Society of Agronomy, Inc., Soil Science Society of America, Inc. Madison, Wisconsin, USA.
- Department of Land Development 1981. Soil Survey Report of Songkhla Province (in Thai).
- John Taylor & Sons 1985. Songkhla Lake Basin Planning Study, Main Report.
- Meteorological Department, 1994. Meteorological Data Report No. 582.
- Pipithsagchan, S., Kanatharana, P., Siriwong, C., Kammalrat, A. and Chatupote, W. 1994. Impact of the use of agrochemicals on water resources in southern Thailand. ACIAR Proceedings No. 61, Agricultural Impact on Groundwater Quality. Canberra, Australia: 71–76.

General Management Practices in the Agroecosystems of Rataphum Watershed Area

A. Kamnalrut, S. Choto and S. Pipithsangchan¹

Abstract

Studies were carried out on farmers' management practices in fruit, rubber and vegetable agroecosystems to assess the dependence of farmers on agrochemicals. The intensity of agrochemicals used by farmers depended on several factors including choice of crop and cropping patterns, level of pest and weed infestation, and the socio-economic factors such as capital, size of holding and labour availability. It was found that agrochemical use was most intensive in the vegetable agroecosystem, followed by the fruit and rubber agroecosystems. Moreover, vegetable farmers tended to misuse chemical pesticides or apply them inappropriately, thus risking agrochemical toxicity.

AGRICULTURAL ACTIVITIES in particular areas differ depending on their biophysical and socio-economic circumstances (Conway 1985).

The Rataphum watershed is one of the most important sub-watersheds of the Songkhla Lake Basin. General agricultural landuse patterns of the watershed are described by Panapitukul and Chatupote (2001), and can be reclassified for the purpose of this study into three main agroecosystems: fruit, rubber and vegetable. There is little information about management practices in these agroecosystems especially with regard to agrochemical use by farmers. The purpose of this study is to identify the management practices of farmers in each agroecosystem in order to assess the problems of using agrochemicals, and the potential risk of their contaminating water resources.

Methodology

An informal survey, referred to as a reconnaissance or exploratory survey by Shaner, Philipp and Schmehl (1982), was used to obtain primary information on the general situation and identify problems during an initial stage of the investigation in 1998. The methodology included observations in the farmers' fields and farmer interviews. A formal survey was conducted after obtaining the results from the informal one in order to verify the accuracy of observable facts such

as pests and planted crops, pesticide application, irrigation practices, cropping sequences, and farmers' attitudes towards changing their practices. This was done by semi-structured interview as described by Grandstaff and Grandstaff (1985).

Results

Management practices in the fruit agroecosystem

The fruit-growing area is located at the foot of the hills along the highway in the southwest part of the Rataphum watershed. The main crops grown in the area are durian, rambutan, longon (*Lansium*), jackfruit and mangosteen.

Most farmers grow two or three species, a popular cropping combination being durian with longon and mangosteen. They are traditional small-holders with land for fruit-growing of about 3–8 rai (0.48–1.28 ha) in addition to 5–8 rai (0.8–2.4 ha) of rubber plantation. They depend on natural rainfall and account for some 80 per cent of the farming in that agroecosystem. The income generated from fruit production supplements their main income which is from rubber production. Hence, this type of farmer does not invest much on production inputs such as fertilisers, pesticides, and irrigation systems for their normal-management practices.

¹ Faculty of Natural Resources, Prince of Songkla University, Thailand

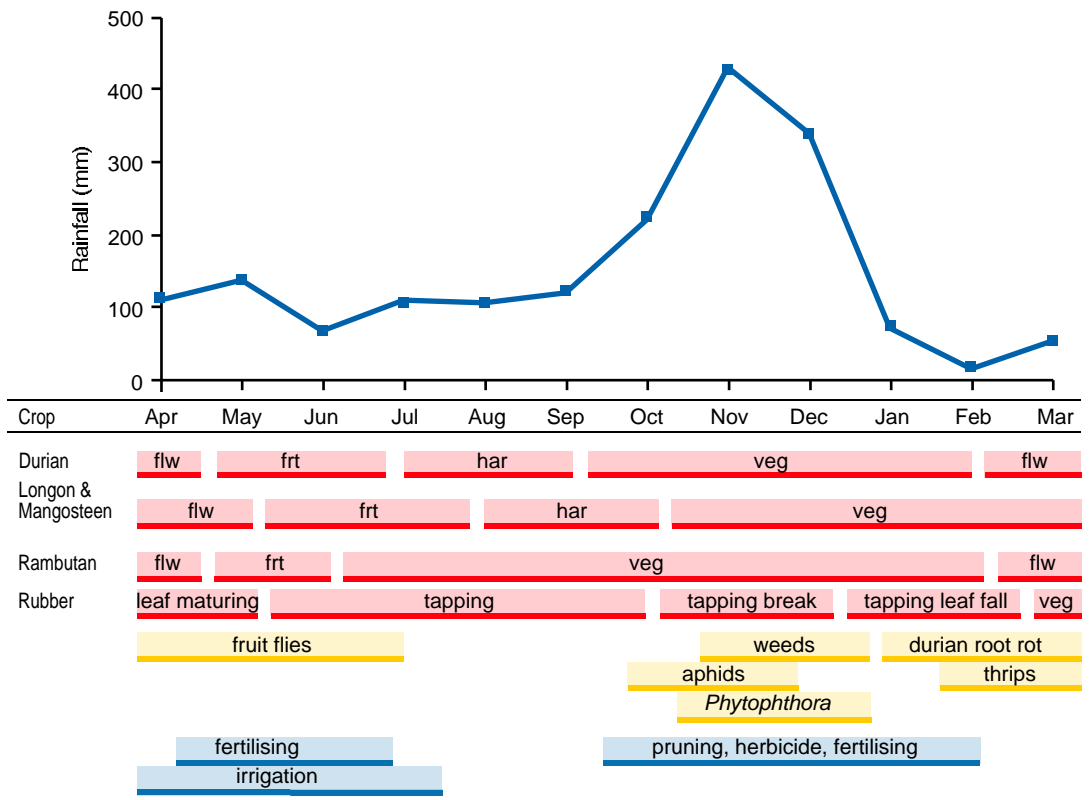

Notes: veg = vegetative growth; flw = flowering; frt = fruit development; har = harvest

Figure 1. Fruit and rubber cropping patterns.

Another group of fruit growers is regarded as commercial. These farmers usually have at least 15 rai (2.4 ha) of land for their fruit orchards. They grow crops such as durian, longon, rambutan, mangosteen and newly-introduced mandarin citrus, either in monoculture or in combination with another one or two species. Advanced technologies such as drip irrigation, application of pesticides and plant growth hormones, chemical fertilisers and animal manure are usually used. Though this new type of cropping constitutes less than ten per cent of this particular agroecosystem, there is great potential for expansion in the future due to its land and location suitability.

The seasonal growth and development sequences (phenology) of the main fruit crops in the area normally correspond with the annual rainfall pattern (Figure 1). There are only slight differences in vegetative and reproductive growth among species, which determine the timing of management practices and fruit harvesting. Occurrences of weeds, insect pests and disease infestations depend also on climatic

conditions, especially the wet and dry periods during the year.

Common management practices

Most of the traditional fruit growers, as mentioned earlier, use minimum inputs in their normal practice. Animal manure either from chickens or cows is occasionally applied to the mature fruit trees depending on the availability of their own or their neighbours' animal waste products. With young fruit trees about 1–4 years old, herbicide, either glyphosate or paraquat at about 3 L/ha, is often used once a year after the rainy season. Animal manure is applied irregularly once or twice annually before the trees flush new leaves.

Observations in 1998 of the experimental sites Kp1–Kp5 which represent most commercialised fruit-growers, showed that farmers usually used herbicides after the rainy season (late December). No insecticides or fungicides were used in the farms, except for one case (Kp2) where mandarin (citrus) is grown (Table 1). In that case, insecticides (methomyl, cyhalothrin, dicofol and propagite) and fungicides (agriomycin and benomyl) were applied at leaf-flush-

ing, flowering and fruit-setting stages (March–April). In all cases, chemical fertiliser, commonly 15–15–15, was applied at an average rate of about 50 kg/rai (310 kg/ha), once or twice during the early-flowering stage (February–March) and the early fruit-development stage (May–June). One bag of 12 kg chicken manure was usually applied for each tree in 1–2 year intervals either after harvesting or before the rainy season (September–October).

Future trends

Based on the information obtained, it is likely that there will be little change in fruit-cropping patterns in the foreseeable future. Traditional fruit-cropping will remain predominant, and commercial cropping will not increase greatly. The economic crisis of the late 1990s considerably affected agricultural production activities. Cutting expenses on inputs will result in less agrochemical application by large-scale farmers.

Management practices in the rubber agroecosystem

Most of the land in the upper part of the Rataphum watershed is used for growing rubber, and most of the rubber plantations belong to small-holder farmers with about 10–20 rai (1.6–3.2 ha) of land per family. As already mentioned, rubber production is the main source of farmers' income. Almost all village households, including the fruit-growers, gain their primary income from rubber production. Most farmers have limited capital, so management systems in rubber production are extensive.

The seasonal rubber growth cycle and related activities are shown in Figure 1. Normally, the tapping period of rubber is about 5–6 months a year with three breaks: around the period of leaf-fall and leaf-flushing around mid-February to mid-March; in heavy rainfall in the rainy season around mid-October to mid-December; and in occasional heavy rains which occur in some months. Weeds occur mostly in the rainy season. In some years, *Phytophthora* leaf

disease causing leaf-fall occurs also in the wet season, but seems to have no serious effect on rubber growth.

Common management practices

It is estimated that 90–95 per cent of the total rubber plantation area consists of mature rubber trees. The remaining 5–10 per cent consists of 1–6 year-old untapped rubber trees. This is an important figure, since agrochemical inputs are much more regularly applied to young rubber trees than mature ones. This is because farmers get subsidised inputs from the Government under a rubber replantation program for six full years following replanting.

During this time, farmers must follow the recommended practice of herbicide application once or twice per year. Either glyphosate or paraquat are applied after the rainy season stops (December–January). This is followed by a second application with an average rate of about 0.5 litres/rai (3.13 L/ha) in May or June if any weeds appear. Fertiliser is applied twice a year before the first rainy season (around April) and again in August or September. A common fertiliser for rubber is 16–8–4; the amount applied is about 40 kg/rai/year (250 kg/ha/year) with 1–2 year old rubber, and double or about 1 kg/plant with 3–4 year-old rubber trees. After being released from the replantation program, less fertiliser is used. In a few cases, farmers grow vegetables between young rubber trees as in the case of site Tp1. In these cases, the intensity of pesticide and herbicide use is high.

Future trends

Rubber plantations will remain predominant in the upper land terraces. The area might be expanded subsequently into the encroached forest areas, but at a slower rate than in the past since enforcement from the law is now more effective. There will be no apparent changes from normal practices. The intensity of the use of agrochemicals, however, will depend largely on how much replantation occurs each year.

Table 1. Types and application rates of pesticide used in fruit-growing in certain areas.

Site	Area (ha)	Cropping Pattern	Insecticide	Rate (L/ha)	Fungicide	Rate (L/ha)	Herbicide	Rate (L/ha)
Kp1	4.8	durian, lime	–	–	–	–	paraquat	3.12
Kp2	5.6	mandarin (citrus)	methomyl cyhalothrin dicofol propagite	3.12	agriomycin benomyl	3.75	glyphosate	3.12
Kp3	4.8	durian, longon	–	–	–	–	paraquat	3.12
Kp4	3.2	durian, longon, mangosteen	–	–	–	–	paraquat	3.12
Kp5	1.6	durian, rumbutan, longon	–	–	–	–	–	–

Management practices in the vegetable agroecosystem

The vegetable growing area can be divided into two sub-areas. The first sub-area is characterised by relatively large growing areas of about 6 rai (1 ha) on average per family, and the land is rented to non-local farmers. This type of vegetable growing is considered to be 'commercial' production. The common vegetables grown by these farmers are kale (*Brassica alboglabra*), chaisim (*B. pekinensis*), and petsai or Chinese cabbage (*B. chinensis*) which have growing periods of about 30–40 days. This sub-area includes the sampling sites Bp1, Bp3, Bp4, Bd1–3, Bw1, Bw4, and Bw7.

The second sub-area is characterised by smaller growing areas, typically less than 2 rai (0.3 ha). They are located around houses and are considered as 'home-garden' growers. This is the area of old dwellers living in villages close to Songkhla Lake. The common vegetables grown in this area are somewhat different from those in the first sub-area. They are cauliflower (*B. oleracea* var. *botrytis*), broccoli

(*B. oleracea* var. *italica*), shallot (*Allium sepa* var. *aggaegatum*), chilli (*Capsicum* spp), lettuce (*Lactuca sativa*) and water convolvulus (*Ipomaea reptans*). This sub-area includes the sampling sites Bp5, Bp7–9, Bp11, Bw8, Bw10–12, Bw14, Bd5, Bd7–9, Bd11 and Bd13.

Cropping patterns of vegetable-growers varied considerably. They differed between the two groups of farmers mentioned earlier. The choice of vegetables depends mainly on vegetable prices, size of land, time and labour availability. The case examples of cropping patterns in the commercial growers (Bp1 and Bp4) and in the home garden (Bp5, Bp7, Bp8 and Bp11) are illustrated in Figure 2.

In the commercial vegetable-growing area most farmers grew almost the same vegetable species, often short-maturing ones in order to achieve more cycles per year. Cropping in such a large area and with several cropping cycles results in intensive management in terms of labour, pesticide, herbicide, and fertiliser use and irrigation practice.

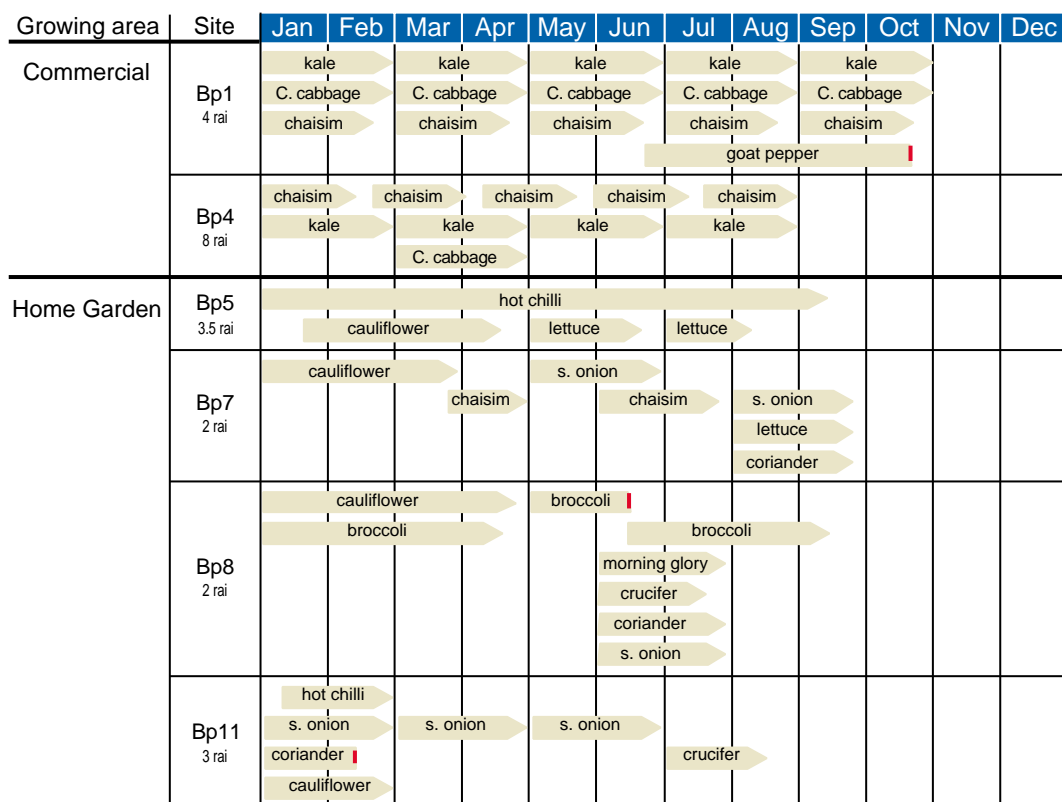

Notes:  = cropping discontinued due to drought conditions; 6.25 rai = 1 hectare; C. cabbage = Chinese cabbage; s. onion = spring onion

Figure 2. Vegetable cropping patterns in certain areas.

Different cropping patterns were seen in the home-garden vegetable-growing type where long-maturing species such as cauliflower, broccoli and chilli were commonly grown with some short-maturing species such as spring onion or shallot, lettuce or chaisim. Although these farmers were engaged in less intensive agricultural production, they still depended on pesticides and fertilisers for a good harvest. Insecticides, herbicides, fertilisers were still unavoidable.

Common management practices

Commercial growers used practices such as:

- land preparation (ploughing, seed-bed raising and seed-bed sun-drying) for about 7–15 days
- spreading chicken manure on the seed-bed before seed broadcasting
- applying urea fertiliser (46–0–0) when seedlings are about 7 days old
- using sprinkler irrigation twice a day when there is no rain
- applying second fertiliser (15–15–15) about 20–22 days after planting
- applying herbicide after every harvest
- applying insecticides at an interval of 3–5 days throughout the period of crop growth.

Home garden growers used practices such as:

- land preparation (ploughing, seed-bed raising and seed-bed sun-drying) for about 7–15 days

- spreading chicken manure on the seed-bed prior to seed broadcasting
- applying urea (46–0–0) for *Brassica* at around the 7-day-old seedling stage
- watering manually with a hose twice a day on p 5-5 dry days
- transplanting in the case of broccoli and cauliflower when seedlings were about 25–30 days old
- second fertiliser application (15–15–15) 7 days after transplanting, or 30–37 days after planting
- third fertiliser application (15–15–15) about 20 days before flowering, or 57 days after planting for broccoli and cauliflower
- fourth fertiliser application (15–15–15) about 77 days after planting for broccoli and cauliflower
- using herbicide once at the beginning of growing season before land preparation (end of December or beginning of January)
- using insecticides whenever the crops were attacked by insects (the frequent use of insecticides would be during the second and third crop cycles).

The general types and application rates of pesticides, herbicides and fertilisers for vegetable crops are presented in Tables 2 and 3. Since there were many kinds of agrochemicals being used in the vegetable agroecosystem, a detailed survey of types and amounts was conducted (Pipithsangchan, Sritungnan and Choto 2001).

Table 2. Types and application rates of pesticide used in vegetable cropping.

Crop	Insecticide	Rate (L/ha)	Fungicide	Rate (L/ha)	Herbicide	Rate (L/ha)
Chinese kale	profenofos	24.0	captan	6.25	paraquat	3.12
Chinese cabbage	mevinphos	1.25	carbendaim	3.75	metolachlor	3.75
	carbosulfan	9.37				
chaisim	cartap	3.75	Cu oxychloride	3.75		
cauliflower	methamidophos	3.75	mancozeb	3.75		
broccoli	cyhalothrin	3.12	ridomyl	3.75		
	fenvalerate	2.50				
	<i>Bacillus thuringiensis</i>	1.45				
lettuce	abamectin	1.50				
	profenofos	24.00	captan	6.25	paraquat	3.12
coriander			carbendazim	3.75	metolachlor	3.75
	cyhalothrin	3.12	carbendazim	3.75	paraquat	3.12
spring onion	profenofos	24.00			metolachlor	3.75
	cyhalothrin	3.12	captan	6.25	paraquat	3.12
	methamidophos	3.75	carbendazim	3.75	metolachlor	3.75
hot chilli	fenvalerate	2.50				
	cyhalothrin	3.12	carbendazim	3.75	paraquat	3.12
	carbosulfan	9.37	captan	3.75	glyphosate	3.12
	methamidophos	3.75	ridomyl	3.75	metolachlor	3.75

Note: *Bacillus thuringiensis* is an entomopathogenic bacterium

Table 3. Types and application rates of fertiliser in vegetable cropping.

Crop	Crop No. or year	Chemical Fertiliser (kg/ha/crop)			Chicken Manure (kg/ha/year)
		N	P ₂ O ₅	K ₂ O	
Chinese kale	5	1280	315	315	24 000
Chinese cabbage	5	1280	315	315	24 000
chaisim	5	1280	315	315	24 000
cauliflower	2	720	365	378	20 100
broccoli	2	720	365	378	20 100
lettuce	3	1280	315	315	20 100
coriander	3	520	270	270	7 800
spring onion	4	1280	315	315	20 100
hot chilli	1	340	216	216	18 000

Future trends

The use of agrochemicals in the vegetable-growing area will increase. This is because more non-local farmers are migrating into the area to grow vegetables for commercial sale. In the case of the home garden type, farmers seem to be more aware of controlling insect pests by using less intensive agrochemicals or using them only when necessary. Moreover, government agencies have tried to promote so-called 'hygienic vegetables' production in this area; this will be discussed later.

Discussion

Most farmers in traditional fruit-cropping areas and old rubber plantations used relatively low agrochemical inputs. Only about ten per cent of all fruit-growers used technologies such as chemical fertilisers, herbicides and pesticides. Young untapped rubber plantations comprising about 10–15 per cent of the rubber agroecosystem were found to receive herbicide and chemical fertiliser application regularly, because most were under the Government rubber replantation program. Therefore agrochemical contamination was low in relation to the whole Rataphum watershed. Only in some specific areas, and in a few cases such as the mandarin fruit orchard and vegetable-growing between young rubber rows, was agrochemical use high.

In the vegetable agroecosystem, high input of agrochemicals was found, especially with the new group of farmers coming from other provinces. Due to the high demand for vegetables, the area of vegetable-growing has increased. Accumulation of chemical toxic substances in the soil and water is therefore expected. Some Government agencies such as the Department of Agriculture and the Department of Agricultural Extension are aware of these problems. Since 1995, they have introduced some packages of technologies to the farmers in order to minimise pesticide and herbicide use. These include growing

vegetables in nylon net, insect light traps, herbal plant extract, and biological control.

Supasawatkul (1999) evaluated those farmers who joined the so-called 'hygienic vegetable' production program and found that it was not very successful in practice. This was because the price of hygienic vegetables was not high enough to cover production cost and the market for these specially-treated vegetables was quite narrow. Early in 1999, the Government allocated some money for farmers to produce hygienic vegetables by growing under nylon net, working closely with some private-sector organisations. It was hoped that this new project would solve the problems of vegetable prices and would bring good incentives to farmers to accept it. Alternative technologies to reduce agrochemical use by farmers now seem possible, since the price of agrochemicals has risen since the beginning of the 1997 Thai baht devaluation.

The choice of crop protection method primarily depends on farmers' knowledge of the effectiveness of certain pesticides and their correct application method. Most farmers still lack adequate information about the positive and negative effects of chemical pest control and appropriate application methods for optimal use. According to the study, many farmers tended to misuse chemical pesticides. Evidence for such misuse was that farmers:

- experimented with pesticides, often creating a 'cocktail' (mixture) of various chemicals
- frequently increased the concentration of pesticides, in the belief that increased intensities lead to greater protection
- did not target specific pests with specific pesticides so as to minimise the time spent on the field
- had a strong preference for pesticides that wipe out pests rapidly, so they often tended to use the most chemical-intensive pesticides with a quick impact
- mostly did not keep to the required safe period between spraying and harvesting

- did not dispose of empty pesticide containers appropriately, many leaving their empty pesticide containers on the ground in their farm.

Also, farmers applied herbicides (glyphosate or paraquat) to vegetable crops after every harvest, causing the destruction not of only insect pests but also of their natural enemies and some beneficial insects.

Conclusions

There are considerable differences in management practices amongst the three agroecosystems. The vegetable agroecosystem surpassed others in its dependence on fertilisers and pesticides. The fruit and rubber agroecosystems, in general, used less agrochemicals and animal manure except for few cases with mandarin orchards and vegetable-growing between young rubber trees. Moreover, misuse by farmers was widespread. To minimise pollution risk, especially in the vegetable agroecosystem, suitable management practices and control measures should be considered.

References

- Conway, G.R. 1985. Agroecosystem analysis for research and development. Winrock International, Bangkok.
- Grandstaff, T.B. and Grandstaff, S.W. 1985. Semi-structured interviewing. Presented at International Conference on Rapid Rural Appraisal, Khon Kaen, 2–5 September.
- Panapitukul, N. and Chatupote, W. 2001. Soils, landforms and landuse in the agroecosystems of Rataphum Watershed Area, and the risk of chemical pollution. These Proceedings.
- Pipithsangchan, S., Sritungnan, S. and Choto, S. 2001. On-farm comparisons between bio-insecticides and synthetic insecticides in vegetable production. These Proceedings.
- Shaner, W.W., Philipp, P.F. and Schmehl, W.R. 1982. Farming systems research and development: Guidelines for developing countries. Westview Press, Boulder, Colorado.
- Supasawatkul, P. 1999. Evaluation of hygienic fresh fruit and vegetable production pilot project: A case study of Khuan Niang District, Songkhla Province. MSc. Thesis, Mahidol University, Bangkok.

On-farm Comparisons between Bio-insecticides and Synthetic Insecticides in Vegetable Production

S. Pipithsangchan, S. Sritungnan and S. Choto¹

Abstract

On-farm comparisons of bio-insecticide and synthetic insecticide use in chaisim (*Brassica pekinensis*) production were made in vegetable agroecosystems in Bangriang sub-district, Songkhla, Thailand, in November–December 1999. Chaisim was planted in two experimental sites by two different farmers. Bio-insecticides (the bacterium *Bacillus thuringiensis* and the nematode *Steinernema carpocapsae*) and synthetic insecticides (cypermethrin, profenofos, and chlorfenapyr) were applied using a randomised complete block design, with three treatments and two replications. The occurrence of insects (flea beetles and Lepidopterous larvae) was monitored every four days after crop germination. The results suggested that synthetic insecticide is potentially more effective than bio-insecticide. There were no significant differences on vegetable yields among the treatments, but use of synthetic insecticides achieved a higher net income than bio-insecticides because of the higher cost of nematode application. This is a preliminary result which must be verified by controlled experimentation.

IN ALMOST ALL Southeast Asian countries where crucifers are cultivated, Diamondback moth (*Plutella xylostella*) and flea beetle (*Phyllotreta sinuata*) have been perceived by farmers as very serious insect pests. The larval stage of Diamondback causes most damage, mainly on leaves. The larva chews the undersurface of leaves and consumes all the tissues except the veins, which results in the formation of irregular holes (Tikavatananon 1997; Vatanatung 1978; Pipithsangchan 1985). By contrast, the adult flea beetle chews the upper surface of leaves and consumes all the tissue except the veins, which results in the formation of many circular holes (Tikavatananon 1997).

In Thailand, the family cruciferae is one of the major vegetable crops planted; some 64 000 ha are planted annually. Vatanatung (1978) observed that the Diamondback moth and the flea beetle have on average caused 31 and 21 per cent yield losses, respectively, to crucifers between 1960 and 1978. This results in heavy insecticide use by farmers. For them, crucifer cultivation seems impossible without such insecticide use. They perceive that insecticidal

mixtures are necessary and generally desirable. A survey of vegetable production systems in Rataphum district, Songkhla province, showed that there were 13 insecticides applied on Diamondback moth, flea beetle and cabbage worm (Panapitukul and Chatupote 2001). The application of insecticides on flea beetle started when the seedlings were five days old and continued until they were 25 days old, while the application of insecticides on Diamondback moth and cabbage worm started when the seedlings were 15 days old and continued until harvesting. Farmers usually set the spray interval to about 5–7 days.

The unilateral approach by the farmers in trying to overcome the insect pest problem with synthetic insecticides has itself generated other undesirable effects. Broadly, these are:

- development of insecticide resistance
- accidental insecticide poisoning
- hazards in the environment
- greatly increased cost of production.

¹ Faculty of Natural Resources, Prince of Songkla University, Thailand

Recognition of these problems has spurred an increasing interest in bio-insecticides. The aim of the experiment reported in this paper was to compare the effectiveness and cost-benefit of commercial bio-insecticides (the entomopathogenic bacterium, *Bacillus thuringiensis* and the nematode, *Steinernema carpocapsae*) with synthetic insecticides (cypermethrin, profenofos, and chlorfenapyr) on the production of chaisim in the vegetable agroecosystem of Bangraing subdistrict, Songkhla province.

Materials and Methods

The present study was conducted on two separate farmers' fields located in the Bangraing sub-district. Chaisim were planted at the beginning of November 1999. The experiment was conducted using a randomised complete block design (RCBD) with three treatments and two replications for each of the fields. The three treatments were:

- T1 – *B. thuringiensis* + *S. carpocapsae*
- T2 – *B. thuringiensis* + cypermethrin + *S. carpocapsae* + profenofos
- T3 – chlorfenapyr + profenofos.

The plot size for each treatment was 4 x 60 m, with a broader row of the same size laid between the treatment plots to prevent pesticide treatment effects overlapping. The amounts of insecticide, the number of sprayings, and spraying interval were decided by farmers (Table 1).

Numbers of Lepidopterous larvae and flea beetles were monitored every four days from germination until harvesting. The cost of insecticides and labour used were estimated and offset against the benefit gained from marketable yields to obtain the net income.

Results and Discussion

The number of flea beetles was reduced significantly when treated with synthetic insecticides alone (T3) compared with the other treatments. This effect was

pronounced at 9, 12 and 15 days after crop germination for Farmer 1, and after 9 days for Farmer 2. The least effective treatment was *B. thuringiensis* + *S. carpocapsae* (T1) (Figure 1).

There were no statistically significant differences in the number of Lepidopterous larvae among the three treatments for either farmer (Figure 2). The larvae were found to attack the crop at a late growth stage, about 15–18 days after germination.

Application of synthetic insecticides alone (T3) achieved the highest net income for both farmers (Table 2) as a result of both higher yield and lower production cost. As may be inferred from Table 1, the use of nematodes in T1 and T2 was the main cause of the high production cost of those two treatments. No significant difference was observed in yields from different treatments. Because the nematodes were more expensive, the synthetic chemicals were seen by growers to be economically more attractive.

The analysis of insecticide residues on vegetables using the rapid bioassay pesticide residue method showed no toxic substances left on chaisim vegetables in any case. Even so, farmers showed interest in the use of those synthetic insecticides which are less toxic than the ones they had been using beforehand.

Conclusions

Comparisons of bio-insecticides and synthetic insecticides showed that synthetic insecticides were more effective in controlling the major insect pests of chaisim vegetable production of the study area. Moreover, net income when using synthetic insecticides was more than that achieved using bio-insecticides. This was due to lower-cost production and better yield obtained from applying synthetic insecticides. Controlled experiments should be conducted with more farmers to confirm these results, to relate them to conventional practices, and to assess acceptance by farmers.

Table 1. Quantities and costs of treatments.

Treatment	Insecticide	Amount	No. of sprayings	Insecticide Cost (baht)	
				Per Insecticide	Per Treatment
T1	<i>B. thuringiensis</i>	40 g	6	142	
	<i>S. carpocapsae</i>	44 packs	2	1760	1902
T2	<i>B. thuringiensis</i>	200 g	5	118	
	cypermethrin	20 ml	1	19	
	<i>S. carpocapsae</i>	22 packs	1	880	
	profenofos	20 ml	1	19	1036
T3	chlorfenapyr	40 ml	2	227	
	profenofos	80 ml	2	38	265

Table 2. Net cost and income comparisons (baht) among treatments.

Treatment	Costs			Farmer 1			Farmer 2		
	Insecticide	Labour	Total	Yield (kg)	Gross Income	Net Income	Yield (kg)	Gross Income	Net Income
T1	1902	480	2382	498	2490	109	370	1850	-532
T2	1036	480	1516	485	2425	910	350	1750	234
T3	265	240	505	523	2615	2111	450	2250	1745

Note: Market price for chaisim was 5 baht/kg.

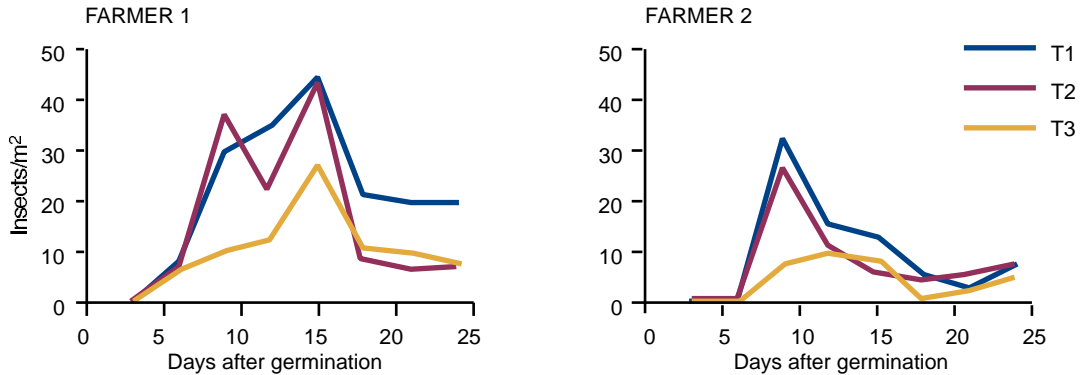

Figure 1. Number of flea beetles on chaisim vegetables at various times from germination for various treatments.

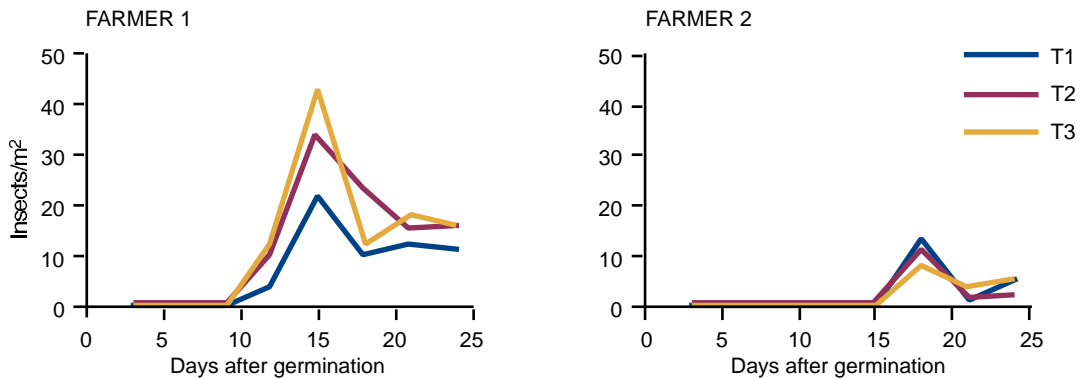

Figure 2. Number of Lepidopterous larvae on chaisim vegetables at various times from germination for various treatments.

References

- Panapitukul, N. Chatupote, W. and 2001. Soils, landforms and landuse in the agroecosystems of Rataphum Watershed Area, and the risk of chemical pollution. These Proceedings.
- Pipithsangchan, S., 1985. Some biological studies on Diamondback moth (*Plutella xylostella* L.). Report submitted for a research program of AVRDC, Taiwan, 40 pp.
- Tikavatananon, S. 1997. Insect pests of vegetables in central region of Thailand and their control, MS thesis, Kasetsart University, Bangkok, 89 pp. (In Thai, with English summary).
- Vatanatangum, A. 1978. Preliminary study on Diamondback Moth *Plutella xylostella* (Lepidoptera: Plutellidae). Entomology and Zoology Divisions, Department of Agriculture, Bangkok, 12 pp.

Bacterial Survey in Groundwater in Rataphum Watershed Area

A. Pengnoo and S. Choto¹

Abstract

A broadscale survey was conducted from March 1997 to November 1998 on coliform bacterial content in groundwater in the rubber, fruit and vegetable agroecosystems in Rataphum watershed, southern Thailand. The results showed that water from all sources (shallow wells, deep wells and streams) from the three agroecosystems were contaminated with coliform bacteria. Coliform contamination was higher in the vegetable agroecosystem with its high inputs of organic and inorganic fertiliser. Seasonal factors, especially dry and rainy periods and resulting fluctuations in water levels, strongly influenced the degree of contamination of water sources.

LANDUSE in the Rataphum watershed is predominantly agriculture (Panapitukul and Chatupote 2001). It has a tropical monsoon climate with the wet season from October to January and the dry season during February and March. The cultivation of rubber, fruit and vegetables are the major agricultural activities (Kamnalrut, Choto and Pipithsangchan 2001). Fertilisers are usually applied to all crops either in chemical form or as animal manure or both, especially in intensive vegetable cropping. Generally, the depth of the shallow wells is 2–10 m. In most cases (>70 per cent) the farmer's home is surrounded by fruit or vegetable gardens and the household septic tank or latrine is located in the vicinity of the drinking well. These factors are likely to be the major sources of bacterial contamination of the water used by local villagers.

Coliform bacteria are defined as all the aerobic and facultatively aerobic, gram-negative, non-spore forming, rod-shaped bacteria that ferment lactose with gas formation within 48 hours at 35°C. They include *Escherichia coli* (a common intestinal organism), *Klebsiella pneumoniae*, and *Enterobacter aerogenes* (not generally associated with the intestine) (Brock et al. 1994). The intestinal bacteria are indicators of excrement contamination from humans and warm-blooded animals. They are pathogenic to humans and animals, causing diarrhoea, dysentery,

gastroenteritis and typhoid fever. Coliform bacteria are also called faecal coliform (Atlas 1989).

There is very little information about microbiological contaminants in water resources in southern Thailand. Water quality assessment of domestic water supplies in villages around Pattani Bay reported by Tanskul, Etac and Chaipakdee (1997) showed that 22, 50, 67 and 33 per cent of the water sampled in May, August, and November 1992 and February 1993, respectively, had total bacteria plate counts higher than permissible levels. However, there have been no studies reported on bacterial contamination in the Rataphum watershed agricultural area. Thus, the study of water resources under intensive agricultural activities in Rataphum watershed and their contamination by coliform bacteria is of primary importance to the rural agricultural community.

Materials and Methods

Water samples were collected from deep wells, shallow wells, piezometers and streams in the three agroecosystems: rubber, fruit and vegetables. The water samples were taken seven times between March 1997 and November 1998. Bacterial counting in groundwater in each agroecosystem was carried out for total coliform and faecal coliform using the membrane

¹ Faculty of Natural Resources, Prince of Songkla University, Thailand.

filter method. Endo-agar was used for the detection of total coliform, and M-FC agar for the detection of faecal coliform. The colony counts were taken after 24–36 hours of incubation at 37°C (APHA, AWWA and WPCF 1992). The classification of bacteria content was based on World Health Organisation standards (Table 1).

Results

Total coliform

The proportions of water samples from shallow wells and piezometers with total coliform exceeding 5000

cfu/100 ml of water, and therefore considered to be heavily polluted, are shown in Table 2.

In the rubber agroecosystem the total coliform in all water samples from shallow wells in March and August 1997 and October 1998 exceeded the heavy pollution level, whereas a smaller percentage of samples (14.3–71.4 per cent) was found to exceed this level in October 1997, and February, June and November 1998. The same trend was also found in piezometers, but to a lesser extent (0–60 per cent), indicating the effect of seasonal fluctuation. It is noticeable that this fluctuation was associated with the amount of rainfall and water-level fluctuation

Table 1. Raw water classification according to bacteria content.

Degree of Pollution	Coliform (cfu/100 ml)		Treatment Required
	Total	Faecal	
Light	0–50	0–20	Disinfection
Medium	50–5000	20–2000	Conventional methods (coagulation, sedimentation, filtration, disinfection)
Heavy	5000–50 000	2000–20 000	Extensive treatment
Very heavy	>50 000	>20 000	Specially-designed treatment

Table 2. Proportion of samples containing total coliform exceeding 5000 cfu/100 ml water in various agroecosystems (per cent).

Source	No. of Samples	Mar. 1997	Aug. 1997	Oct. 1997	Feb. 1998	Jun. 1998	Oct. 1998	Nov. 1998
Rubber								
shallow well	7	100.0	100.0	57.1	71.4	14.3	100.0	28.6
piezometer	6	100.0	80.0	60.0	20.0	0.0	100.0	33.3
Fruit								
shallow well	5	100.0	100.0	66.7	44.5	11.1	66.7	66.7
piezometer	6	100.0	80.0	60.0	40.0	20.0	83.3	50.0
stream	4	100.0	100.0	100.0	100.0	0.0	100.0	100.0
Vegetable								
shallow well	10	100.0	100.0	66.7	55.6	55.6	66.7	87.5
piezometer	11	100.0	83.3	50.0	41.8	58.3	50.0	100.0
deep well	9	100.0	77.8	0.0	22.2	0.0	44.4	14.3

Table 3. Proportion of samples containing faecal coliform exceeding 2000 cfu/100 ml water in various agroecosystems (per cent).

Source	No. of Samples	Mar. 1997	Aug. 1997	Oct. 1997	Feb. 1998	Jun. 1998	Oct. 1998	Nov. 1998
Rubber								
shallow well	7	14.3	28.6	14.3	0.0	28.6	42.9	0.0
piezometer	6	40.0	40.0	20.0	0.0	0.0	40.0	0.0
Fruit								
shallow well	5	22.2	33.3	77.8	33.3	11.0	0.0	44.4
piezometer	6	40.0	60.0	60.0	0.0	0.0	16.7	33.3
stream	4	25.0	0.0	50.0	100.0	0.0	0.0	25.0
Vegetable								
shallow well	10	33.3	0.0	0.0	22.2	22.2	22.2	12.5
piezometer	11	81.8	58.3	0.0	0.0	25.0	30.0	27.3
deep well	9	66.7	0.0	0.0	11.1	0.0	0.0	0.0

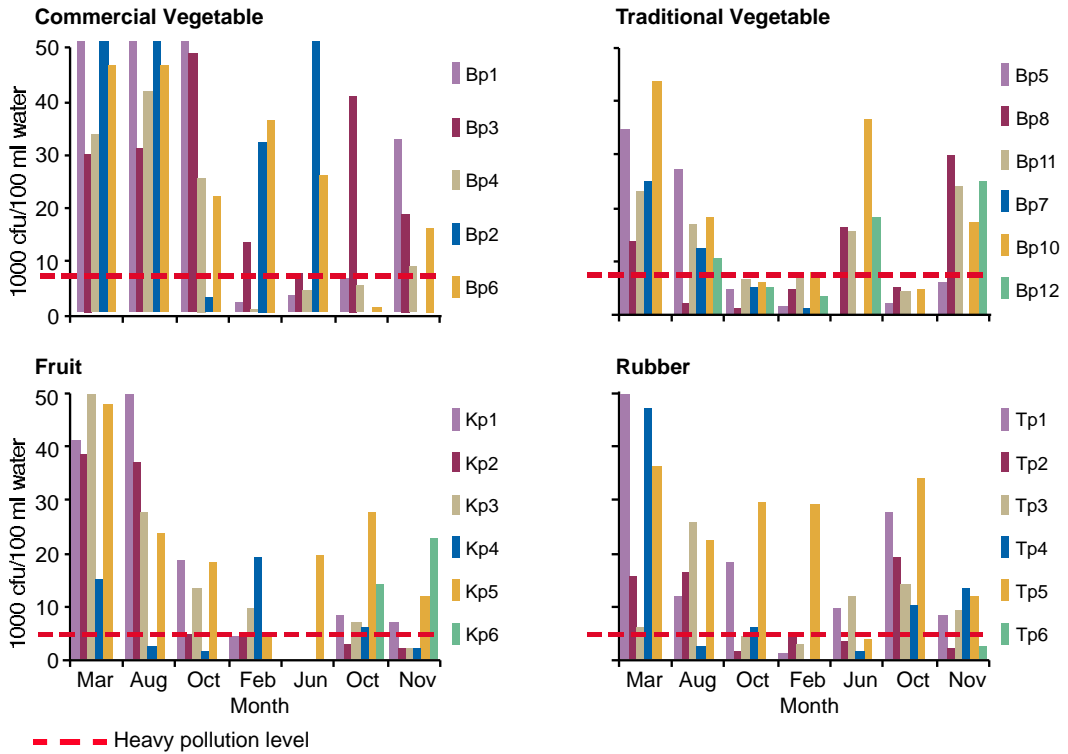

Figure 1. Total coliform counts from piezometer water samples in various agroecosystems.

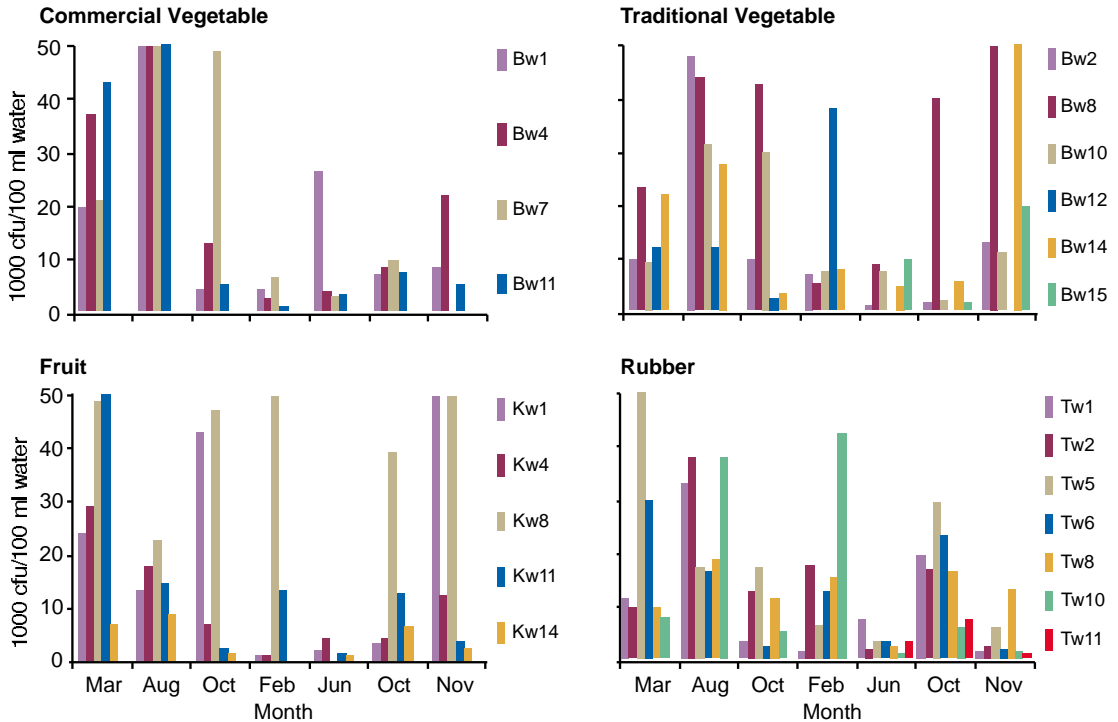

Figure 2. Total coliform counts from shallow-well and streamwater samples in various agroecosystems.

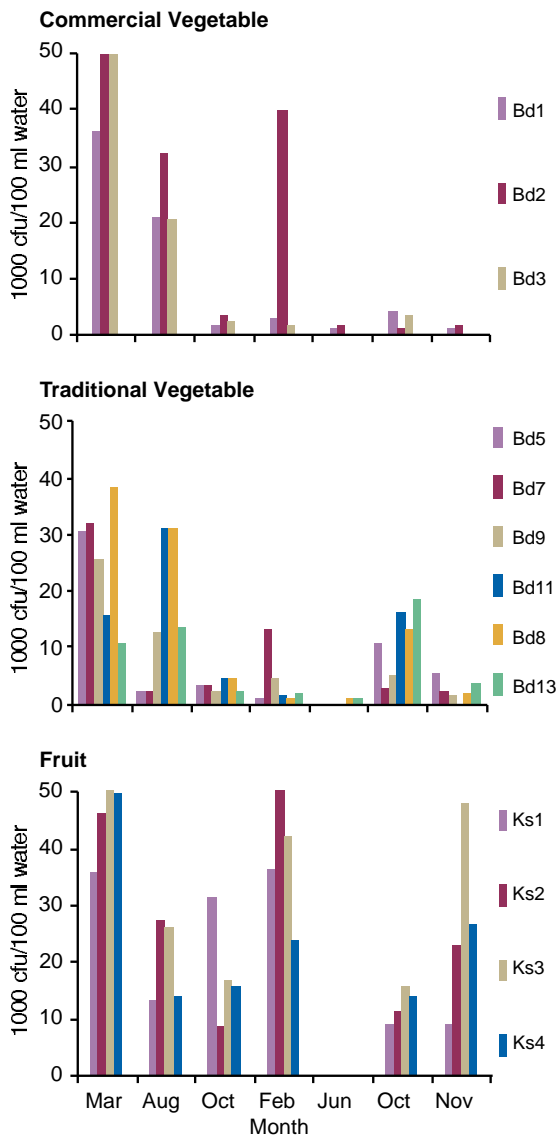

Figure 3. Total coliform counts from deep-well and streamwater samples in vegetable and fruit agroecosystems, respectively.

(Panapitukul and Chatupote 2001). The high total coliform contamination was found in all water samples after the first rainfall events, possibly due to soil moisture conditions and the high nutrient content from the wastes and debris washed from the soil surface becoming concentrated in the water, providing optimum growth conditions for bacteria. This was observed as a general trend also in the fruit and vegetable agroecosystems.

In the fruit agroecosystem all streamwater samples were found to exceed the heavy pollution levels

except in June 1988, when the weather conditions were extremely dry. In general there are more cases of water from shallow wells and piezometers being contaminated with total coliform in vegetable agroecosystems than in the other two areas. However, water samples from deep wells in vegetable agroecosystems were found to have the least contamination during the incidence of high watertables in October 1997, June and November 1998. Total coliform levels in different water sources in the three agroecosystems are shown in Figures 1–3.

Faecal coliform

Incidence of faecal coliform bacteria contamination was found to be less than for total coliform bacteria. Even though water from piezometers tended to follow the same seasonal trend in terms of total coliform bacteria, inconsistent amounts of faecal coliform were found in shallow wells, streams and deep wells throughout the years (Table 3).

The inconsistency was attributed to site-specific factors, notably different human and farming activities surrounding the water resources. In general, more cases of higher amounts of faecal coliform were found in the water resources of vegetable areas than in rubber and fruit agroecosystems, especially in the piezometers (during March and August 1997 and June 1998 for Bp1 and Bp2; and August 1997 and October 1998 for Bp3) (Figures 4–6).

Discussion

Results from the bacterial survey in rubber, fruit and vegetable agroecosystems in Rataphum watershed showed that water from different sources were contaminated with total bacteria. Contamination was especially high in shallow wells and piezometers of vegetable agroecosystems, where the level of contamination was found to be seasonally controlled. Faecal coliform bacteria were found to contaminate less water sources than did total coliform. These were site-specific rather than seasonal manifestations, and it is very likely that in the vegetable cropping areas heavy use of organic (chicken and cow manure) and inorganic fertilisers were the main cause of rapidly-propagating bacterial populations. Low-lying vegetable-growing areas with relatively high watertables throughout the year, frequent irrigation, and frequent cropping cycles were also vulnerable.

During the dry season of 1998 (February–March), low rainfall associated with a deep watertable resulted in a low amount of coliform in water sources for most sites. Also, low contamination was found during the mid-rainy season in October 1997 and November

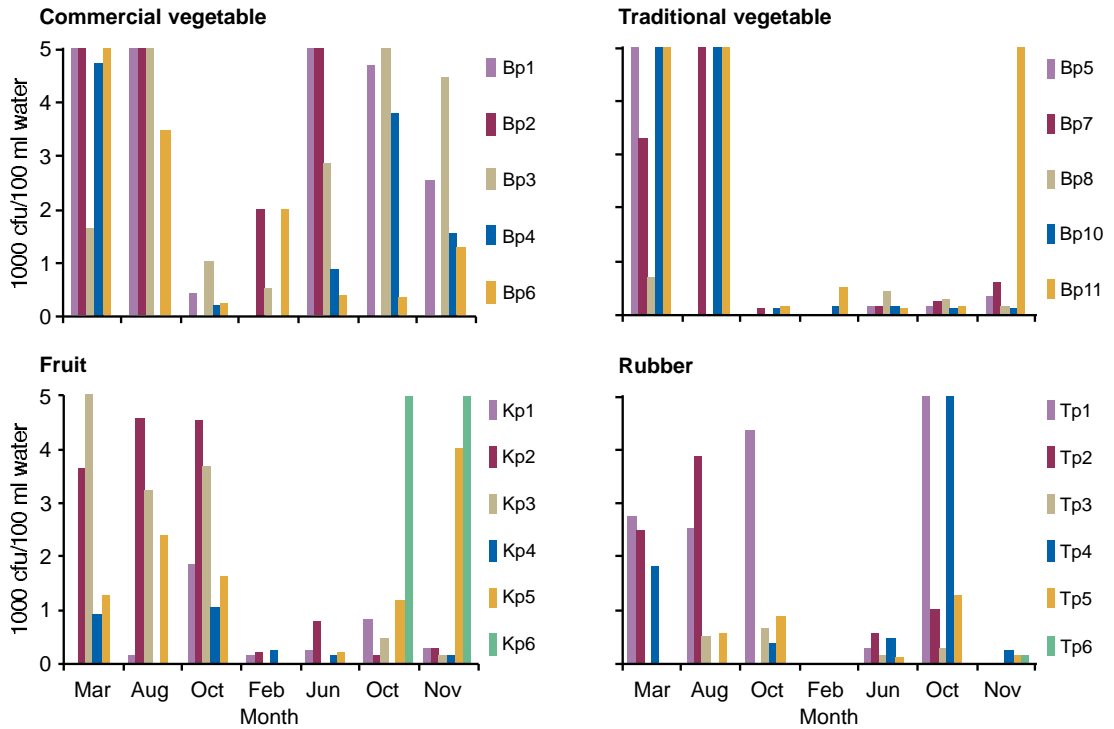

Figure 4. Faecal coliform counts from piezometer water samples in various agroecosystems.

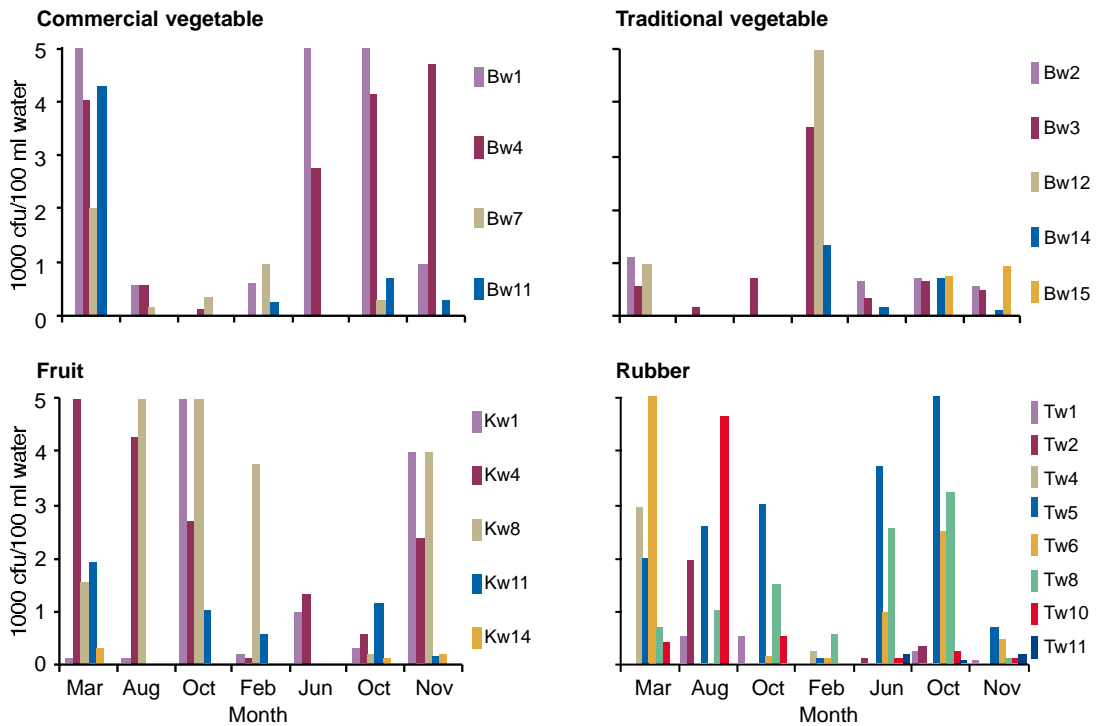

Figure 5. Faecal coliform counts from shallow-well water samples in various agroecosystems.

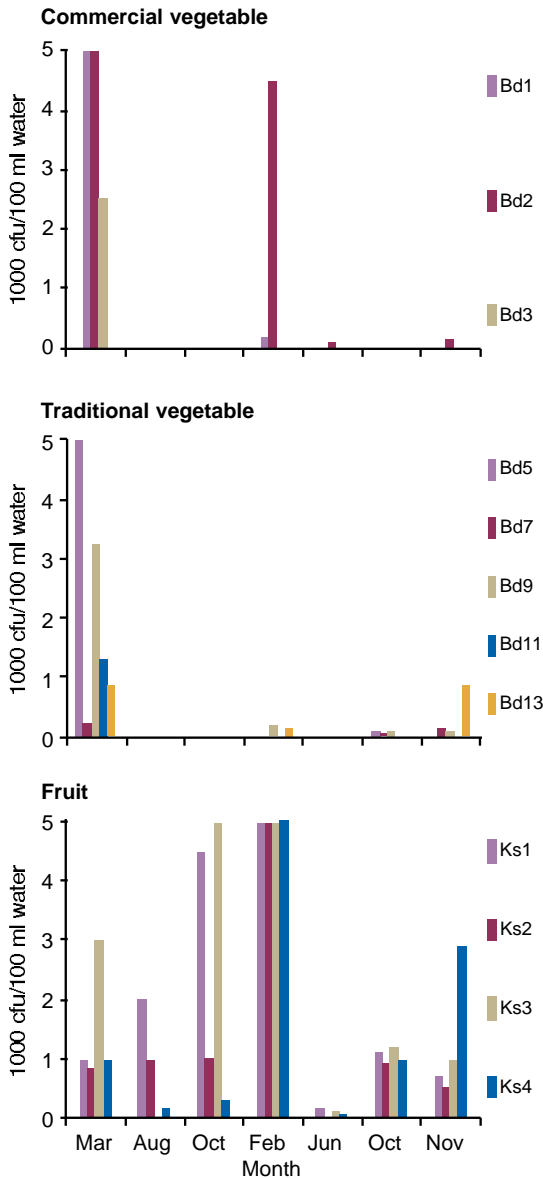

Figure 6. Faecal coliform counts from deep-well and streamwater samples in vegetable and fruit agroecosystems, respectively.

1998 when the early and normal rainy seasons occurred, respectively. This was due to a high amount of rainwater diluting the concentration of bacteria. In the beginning of the wet season (August 1997 and October 1998), early first rains washed out diverse wastes and debris from the soil surface which then became concentrated in the water. This probably provided optimum growth conditions for bacteria, contributing to the high levels of both total and faecal

coliform that were found in every source of water in all agroecosystems.

Generally, non-faecal coliform bacteria are not serious hazards to human or animal health. However, when detected at higher concentrations than those recommended by the WHO for coliform-associated heavy pollution, serious problems to health are likely to occur and water must therefore be treated before use (World Health Organisation 1994).

Conclusions

Contamination by coliform bacteria in water sources depends on the depth of the watertable, amount of rainfall, and human and farming activities. Vegetable agroecosystems which have the most intensive cropping were found to be the most polluted, compared with fruit and rubber agroecosystems. Shallow and deep wells, which provide the major source of drinking water for the villagers, should be protected. Therefore, it is recommended that in such areas purification either by conventional methods or by simply boiling the water should be promoted.

References

- APHA, AWWA and WPCF. 1992. Standard methods for the examination of water and wastewater (18th ed). American Public Health Association Inc., Washington, DC.
- Atlas, R.M. 1989. Microbiology: Fundamentals and Applications (2nd ed). Macmillan, New York.
- Brock, D.T., Madigan, M.T., Martinko, J.M. and Parker, J. 1994. Biology of Microorganisms (17th ed). Prentice-Hall, New Jersey.
- Kamnalrut, A., Choto, S. and Pipithsangchan, S. 2001. General management practices in the agroecosystems of Rataphum Watershed Area. These Proceedings.
- Panapitukul, N. and Chatupote, W. 2001. Soils, landforms and landuse in the agroecosystems of Rataphum Watershed Area, and the risk of chemical pollution. These Proceedings.
- Tanskul, S., Etac, M. and Chaipakdee, W. 1997. Quality determination of water consumed in villages around Pattani Bay using indicator bacteria. *Sonklanakarinn Journal of Science and Technology* 19(4): 487-494.
- World Health Organisation. 1994. Global pollution and health. Results of health related environmental monitoring. Yale Press, London.

Modelling Pesticide and Nutrient Leaching in the Agroecosystems of Rataphum Watershed Area

W. Chatupote and N. Panapitukul¹

Abstract

The agrochemical pollution of water resources in tropical intensive production systems in southern Thailand was examined using several models in three agroecosystems: vegetable, fruit and rubber. The study aimed to compare and identify the leaching potential of commonly-used agrochemicals and their effects on the water resources of the area. The results indicated that the water resources in the vegetable production areas have the highest risk of contamination due to high application rates of pesticides and fertilisers and the shallow depth to watertable, especially during the rainy season. Further field tests using Brilliant Blue FCF as a dye tracer applied to the soil at different agroecosystem locations confirmed that the flow pattern was consistent with the pattern predicted by the models. The modelling results were also used to predict the behaviour of the most commonly-used pesticides, and to determine their leaching potential. This information was used to formulate management practices which could reduce pesticide contamination or leaching to groundwater.

THREE AGROCOSYSTEMS were identified in Rataphum watershed: vegetable farms (at least three crops annually), fruits, and rubber plantations. In addition to heavy applications of chicken manure, inorganic fertilisers were applied at high rates: 550 kg/ha N, 230 kg/ha P and 150 kg/ha K in the vegetable area; 190:80:120 in the fruit orchards; and 180:80:150 in the rubber plantations (Kamnalrut, Choto, and Pipithsangchan 2001).

A wide variety of insecticides and fungicides was used for crop protection. The most commonly used insecticides were carbosulfan, cabaryl, methamidophos, prothiophos, fenvalerate, permethrin and teflubenzuron; the most common fungicides were benomyl, mancozeb, diuron, captafol, chlorothalonil and copper oxychloride. The amount and intensity of use were highest in the vegetable areas, followed by the fruit areas. Vegetable areas, characterised by light-medium soils, shallow watertable and extensive use of pesticides, were expected to have a high leaching potential. Irrigation is essential to supplement natural precipitation, especially during the dry season. Irrigation water comes mainly from shallow groundwater wells, and during rainless

periods was applied almost daily and sometimes even twice a day (Salama, Bin Yousof and Kamnalrut 1998).

Agricultural practices that affect agrochemical leaching include:

- amount of pesticide applied
- pesticide formulation (emulsifiable concentrate, wettable powder, suspension concentrate, or water-dispensable granules)
- timing of the application relative to seasonal rainfall or temperature extremes
- method of application (direct application to soil or foliar spraying)
- cultivation practices
- amount of irrigation water used.

All the leaching models use key soil and pesticide properties. The pesticide parameters used were organic-carbon normalisation sorption coefficient (K_{oc} units of mL/g) and half-life. Pesticides with a larger K_{oc} are expected to be retarded to a greater extent, hence have a longer residence time in the vadose zone and are least likely to leach to groundwater.

¹ Faculty of Natural Resources, Prince of Songkla University, Thailand

Considerable variation exists among reported values of K_{oc} for a given pesticide. These variations in K_{oc} are attributed to variations in the nature of organic carbon, contributions from other sorbent surfaces, contribution of other soil factors and differences in procedures used to measure K_{oc} . The soil parameters used in most of the leaching models were saturated water content, field-capacity water content, wilting-point water content, hydraulic properties, bulk density and organic carbon content.

Several leaching models were used to compare the leaching potential of the commonly-used pesticides in Rataphum watershed. The results were used as indicators to possible pollution levels resulting from different pesticides. Such indicators could be used to formulate management practices aimed at reducing pesticide contamination or leaching to groundwater.

Materials and Methods

Soil sampling and analysis

The major soil-types in each agroecosystem were sampled for the analysis of physical characteristics and other parameters needed for the modelling. The soil samples of the vegetable agroecosystem were taken from Klaeng and Kleang/Bangklam soil series at Bp4 and Bp8 sites respectively (Panapitukul and Chatupote 2001). For the rubber and fruit crop production systems, soil samples were taken from Sungai padi and Ranong/phato/Thungwa association soil series at Tp3 and Kp4, respectively.

Soil samples were taken by driving the sampling ring holder (with a 100 cm² volume) into the soil surface in the hole at different depths. Particle size distribution was measured by the hydrometer method. Organic matter, pH (1:5 soil:water), soil and moisture

retention at -300 KPa and -1500 KPa were measured and analysed by standard methods. Undisturbed soil samples were also collected for the analysis of bulk density and hydraulic conductivity. Saturated soil hydraulic conductivity was measured by either the constant-head or falling-head method, depending on soil permeability.

Dye tracer tests

Tests using Brilliant Blue FCF tracer were conducted in four agroecosystem sites in the watershed. The aim of the experiments was to stain the flow-paths of infiltrating water in the top soil horizons. At each field site a plot of 1.0 x 1.0 m was established for the experiment. The plot was irrigated with 60 litres of a solution containing 160g of tracer. A total of 40 mm of irrigation was applied within one hour. One day after the application of the solution, trenches were dug at each site 30, 60 and 90 cm from one end to the maximum depth to which the dye penetrated. The vertical soil profiles were monitored and photographed to follow the distribution of the dye. A 100 x 100 cm wire grid of 10 x 10 cm grid spacing was placed on the profile surface before photos were taken. The area covered by the dye was measured and the percentage coverage calculated.

Results and Discussion

Soil characteristics

The vegetable-growing area is located on the flat lowland and the soil was formed by the old alluvium. The texture of the soil from site Bp4 was loam to clay-loam and sandy-loam. The soils had very low hydraulic conductivity throughout the profile. Clay accumulated at 25–30 cm below the soil surface. The

Table 1. Leaching potential of the most commonly-used pesticides.

Pesticide	Half-life ($t_{1/2}$) days	Soil Sorption (K_{oc})	Hornsby Index ($K_{oc}/t_{1/2}$) x 10	Leaching Potential
carbofuran	50	22	4	high
methamidophos	6	5	8	high
metolachlor	200	90	22	high
carbendazim	120	400	33	high
alachlor	15	170	113	intermediate
mevinphos	3	44	146	intermediate
glyphosate	47	1105	235	intermediate
mancozeb	70	2000	285	intermediate
captan	3	200	666	intermediate
fenvalerate	35	5300	1514	intermediate
chlorothalonil	30	1380	460	intermediate
endosulfan	50	12 400	2480	intermediate
carbaryl	10	300	300	intermediate
profenofos	8	2000	2500	low
paraquat	1000	1 000 000	10 000	low
cypermethrin	30	100 000	33 333	low
permethrin	30	100 000	33 333	low

organic matter content was medium within 30 cm depth, and the soil pH was mildly alkaline. Soil bulk densities were high due to soil texture and soil compaction. Available water capacity was 5–9 per cent by weight. The groundwater level was near the surface for 3–4 months of the rainy season, and below 2 m in the dry season. The depth to watertable varied between 0.15 and 1.5 m, although usually 0.5–0.8 m, and there were distinct red mottles in the soil profile.

In the vegetable-growing area at site Bp8 located at the lake margin, with parent material of recent marine deposit, the soil texture was loam, varying from loam and sandy-loam to loamy sand. The soils had medium hydraulic conductivity throughout the profile. Organic matter was very low throughout, and soil pH varied from strongly to very strongly acid. Soil bulk densities depended on soil textures. Available water capacity was 8–13 per cent by weight. Organic matter content within the top layer of each soil site depended on the quantity of manure fertiliser application. The depth to watertable varied between 0.45 and 1.5 m, although usually 0.65–1.4 m in which there were distinct red mottles and iron concretion.

Rubber plantations and fruit-production sites (Tp3 and Kp4) were in areas of undulating relief with 2–5 per cent slope. Parent materials were old alluvium at Tp3, and residuum and local colluvium from sandstone in Kp4. Soil textures ranged from loam to clay. The soils had medium hydraulic conductivity throughout the profile. Clay content increased with soil depth. Organic matter content was moderately low within 15 cm depth and low to very low below this depth; pH of the soil was very strongly acidic at Tp3, and slightly acidic at Kp4. Soil bulk densities were high according to the soil texture. The available water capacity for Kp3 was higher than that for Tp3, but Kp3 contained a lot of gravel. The watertable at Tp3 varied between 1.0 and <1.5 m; at Kp4 it varied between 0.75 and 1.5 m in which there was a reddish-yellow to yellowish-red mottle.

Pesticide and nutrient leaching models

The models used in the study were:

- Hornsby Index (HI)
- Attenuation Factor (AF)
- CMLS
- LEACHP
- LEACHN.

Hornsby Index

The tendency of a pesticide to move with water through soils, referred to as leaching potential, is influenced by its chemistry. The Hornsby Index is one measure leaching potential. It combines soil sorption

with the half-life of a pesticide to define a leaching index. The smaller the index, the more likely the pesticide will not be filtered but will leach to the groundwater (Hornsby 1992). Generally, a pesticide with an index of 10 or less is considered to have a high leaching potential, and one with 2000 or greater a low leaching potential. The properties and leaching potentials of commonly-used pesticides in the Rataphum Watershed according to the Hornsby Index are shown in Table 1.

The application of the Hornsby Index formula to the most commonly-used pesticides in Rataphum watershed showed that most of them had intermediate leaching potential. Paraquat, permethrin and cypermethrin had low leaching potentials, due to very high sorption; carbofuran, metolachlor, carbendazim and methamidophos had high leaching potentials, due to very low sorption. However, the risk of leaching of carbofuran, metolachlor and carbendazim to groundwater may be reduced due to their short half-life, except in the vegetable sites because of the shallow groundwater level and extensive use of irrigation.

Attenuation Factor

A ratio of the half-life ($t_{1/2}$) to the organic-carbon normalised sorption coefficient (K_{oc}) for a pesticide can serve as a simple index of its leaching potential; these two parameters can be used to group pesticides in terms of their relative potential for groundwater contamination (Rao and Alley 1993). The AF index is equivalent to the fraction of the applied pesticide mass that is likely to leach past the chosen reference depth. The AF value varies between 0 and 1, larger values indicating a greater contamination potential.

The AF model was used to identify the highly leachable pesticides in various soil-types (Figure 1). For each soil, the pesticides lying below the specific soil line have relatively low potential of contaminating groundwater water, because they have sufficiently long residence time or short half-life, or both. Any pesticides lying above the line have relatively large contamination potential, because they degrade slowly or leach rapidly, or both.

The results of the application of the AF model to different soils of the agroecosystems in the study areas indicated that, in all samples, most of the pesticides had no potential to leach through the soils. This might be due to relatively high organic matter input in most of the agroecosystems which resulted in the filtration of all the pesticides in the surface soil. Also all soil samples had relatively high bulk density and low infiltration rate values which may have contributed to the results.

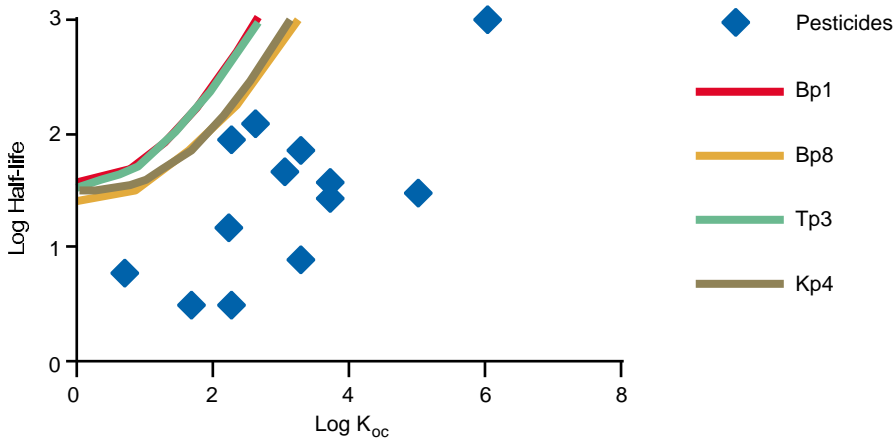

Figure 1. Soil-type control on pesticide attenuation.

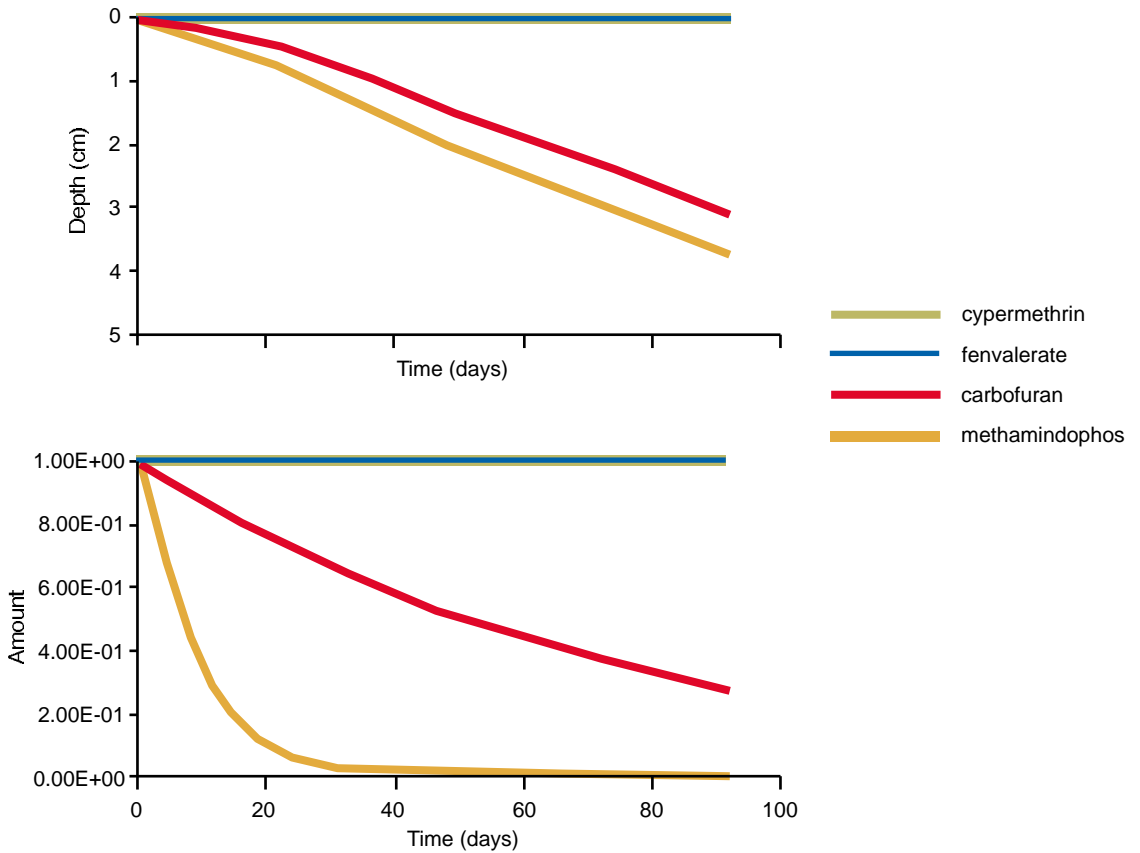

Figure 2. CMLS simulation of selected pesticides in the vegetable agroecosystem.

CMLS

This is a relatively simple model (Nofziger et al. 1982). It estimates the depth of the peak concentration of a pesticide and calculates the relative amount of the chemical in the soil profile as a function of time after application. The model assumes piston flow, and ignores molecular diffusion and hydrodynamic dispersion.

The results of the application of the CMLS model showed that most of the pesticides were highly adsorbed in the top few centimetres of the soil (Figure 2). Only methamidophos and carbofuran leached to a depth of 3–6 cm due to the longer half-life. Pesticides such as fenvalerate and cypermethrin, which have a longer half-life but a relatively high adsorption coefficient, were adsorbed by the organic carbon in the topsoil.

LEACHP

This is the pesticide module of LEACHM, a mechanistic model of water and solute movement and pesticide chemistry (Hutson and Wagenet 1992). It has a flexible system for tracking daughter products by using first-order dynamics to simulate pesticide transformations. The pesticides selected for modelling in the three agroecosystems were:

- fruit (Tp3) — glyphosate, paraquat
- rubber (Kp4) — glyphosate, paraquat
- vegetables (Bp8) — glyphosate, alachlor, phofenofos, metolachlor.

In the vegetable agroecosystem, four pesticides in two different soil-types were used in the simulation of chemical leaching. The flux of glyphosate is shown in Figure 3. The simulation showed that most of the pesticides accumulated in the top 50 cm layer, and only a small amount leached through to the deeper soil layers.

In fruit and rubber agroecosystems, glyphosate and paraquat were applied at the rate of 100 mg/m² for one surface application. The results of that simulation suggested that all of the pesticides used in the fruit agroecosystem were adsorbed in the top few centimetres of the soil due to the high clay content and the compaction of the top soil indicated by the high bulk density of the soil. By contrast, in the rubber agroecosystem the pesticides leached down to the lower soil layers below 100 cm, which indicates that there is a high risk of pesticide contamination of the shallow groundwater in the area.

LEACHN

This module of the Hutson and Wagenet LEACHM model was used to simulate the leaching of nitrogen fertilisers applied to the agroecosystems in the watershed. The results of the modelling (Figure 4) showed that all sites had a high N leaching potential due to the high application rate of N fertilisers (both chemical and chicken manure) and the intensive rain and use of irrigation water.

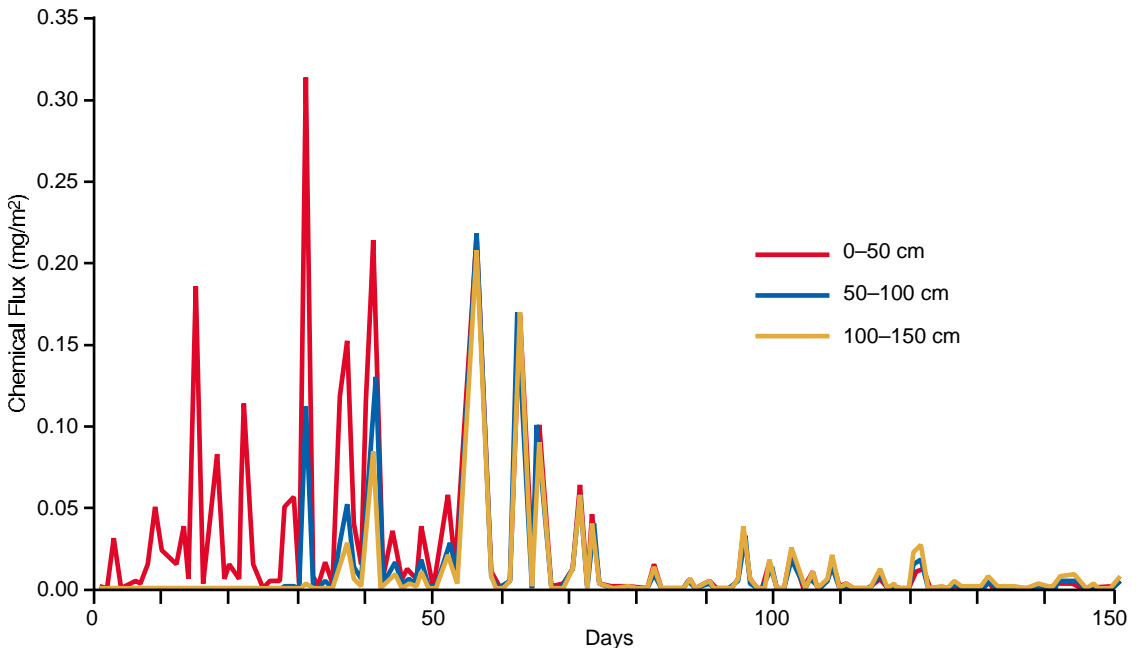

Figure 3. Chemical flux of glyphosate in the vegetable agroecosystem.

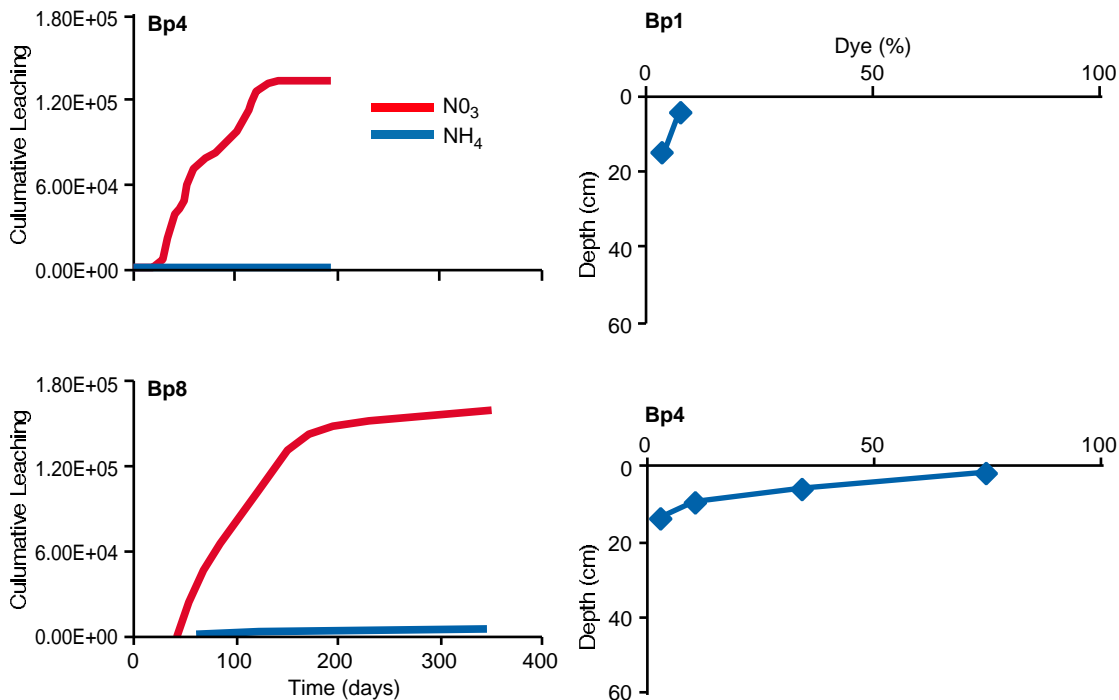

Figure 4. LEACHN simulation for fertilisers used in vegetable agroecosystems (Bp4, Bp8).

The dye tracer tests

Water-flow pathways in the soils at all sites were limited to the top few centimetres (Figure 5). The pathways were irregular depending on moisture content, repellency and preferential wettability potential of the soil in the dry conditions. At site Bp1, preferential flow was more evident and appeared in a fingering path due to the dry condition and very low hydraulic conductivity of the soil. However, at other sites the flow path was more uniform at different rates depending on the variability of the hydraulic conductivity of the soil. The pathways at different sites in the three agroecosystems showed that most of the dye was retained in the top 0–20 cm of the soil. This was consistent with the modelling results.

Management scenarios

Four pesticides (glyphosate, alachlor, perfenophos and metolachlor) were simulated in the vegetable agroecosystems at site Bp4 where the important characteristics of the soil were very low hydraulic conductivities and clay accumulated at 25–30 cm.

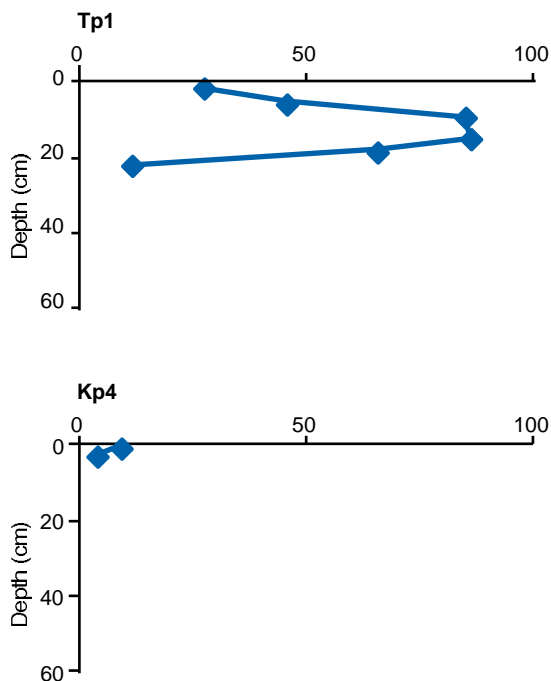

Figure 5. Dye distribution in the profiles of various agroecosystems: vegetable (Bp1 and Bp4), rubber (Tp1), and fruit (Kp4).

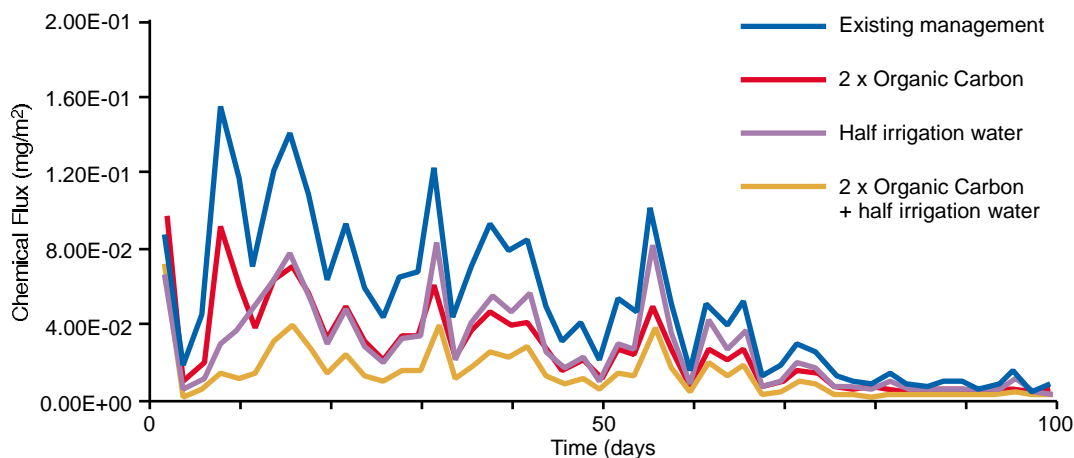

Figure 6. Chemical flux at the top 30 cm layer for different management scenarios.

Several simulations were carried out to find the effects of the different management practices on the leaching of pesticides using LEACHP (halving the amount of water applied, also halved the pesticide):

- doubling the organic carbon content of the top 20 cm of soil
- reducing irrigation water (and therefore pesticide) by half
- reducing irrigation water (and pesticide) by half, and doubling organic carbon.

It was found that all chemicals were retained in the top 30 cm layer. The results of the simulations are shown in Figure 6.

Reducing irrigation water and adding more organic carbon resulted in lower chemical flux to the topsoil layers. This practice significantly decreased the amount of all chemicals in the soil, and reduced the leaching of chemicals. Therefore, the most effective management strategy was to increase the organic carbon content of the topsoil and reduce the amount of irrigation.

Conclusions

The results of the application of leaching models to test pesticide leaching potential indicated that the leaching potential of pesticides in the areas of all agroecosystems of the watershed was relatively low. The risk of contamination with nutrients is much higher due to the mobility and conservative nature of the NO_3 . However, the intensive use of agrochemicals in the vegetable agroecosystems and the shallow groundwater levels, especially during the rainy season, is likely to result in a high risk of pesticide contamination in the area.

References

- Hornsby, A.G. 1992. Site-specific pesticide recommendations: the final step in environmental impact prevention. *Weed Technology* 6: 736–742.
- Hutson, J.L. and Wagenet, R.J. 1992. LEACHM: Leaching Estimation and Chemistry Model, Version 3. Cornell University, New York.
- Kamanalrut, A., Choto, S. and Pipithsangchan, S. 2001. General management practices in the agroecosystems of Rataphum Watershed Area. These Proceedings.
- Nofziger, D.L., Chen, J.S., Wu, J., Ma, F. and Hornsby, A.G. 1982. CMLS98B: The chemical movement in layered soils. Model for batch processing. Division of Agricultural Sciences and Natural Resources, Oklahoma State University.
- Panapitukul, N. and Chatupote, W. 2001. Soils, landforms and landuse in the agroecosystems of Rataphum watershed area, and the risk of chemical pollution. These Proceedings.
- Rao, P.S.C. and Alley, W.M. 1993. Pesticides. *In: Regional Groundwater Quality* (William M. Alley, ed.) VNR, New York: 345–382.
- Salama, R.B., Bin Yousof, A, Kamnalrut, A. 1998. ACIAR Project No. 9454. 1997 Annual report and technical progress report. CSIRO Land and Water Report 98-10.
- Salama, R., Pollock, D. and Byrne, J. 1999. Experimental and modelling results of pesticide leaching in agricultural systems: Examples from Thailand, Malaysia and Western Australia. Solutions and Innovations. Proceedings of an International Conference on Diffuse Pollution, Perth, Australia, 16–20 May: 454–462.

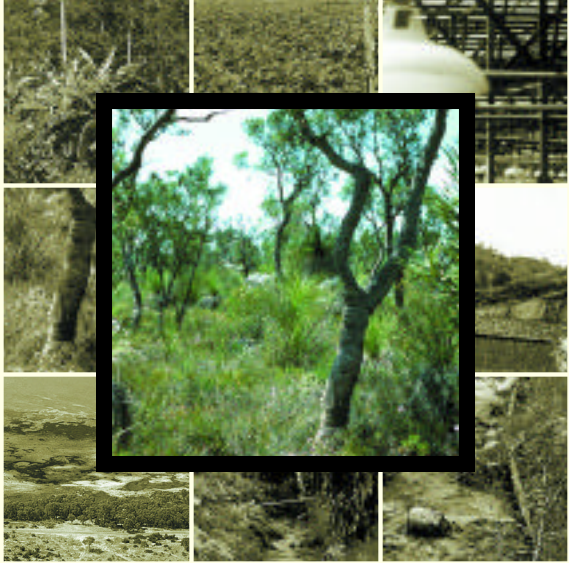

A u s t r a l i a

THE SWAN COASTAL PLAIN near Perth, Western Australia, was the location of the Australian project site. In contrast to the other sites, the climate is Mediterranean, the relief is generally low, and the soils are very sandy. The area supports remnant vegetation and some pine plantations, and is also used for intensive horticultural activities such as market gardens for vegetables, flowers and fruits, and turf farms. The Gnangara Mound aquifer, the main focus of the project, is an important source of water for the city of Perth. So, like the other two sites, protection of water resources from the effects of intensive agricultural production is a well-established priority.

Geomorphology, Soils and Landuse in the Swan Coastal Plain in relation to Contaminant Leaching

R.B. Salama, D.W. Pollock, J.D. Byrne and G.W. Bartle¹

Abstract

A detailed study of the soils of the southern part of Gnangara Mound in the Swan Coastal Plain was carried out to determine their soil-water characteristics and their leaching capacity to nutrients and pesticides. Physical, chemical and hydraulic characteristics of the topsoil (0–15 cm) and the subsoil (40–50 cm) were measured at 21 sites representing the major soils under the different landuses in the area. The results show that Bassendean Sands have higher coarse sand particles and consequently higher hydraulic conductivity than Spearwood Sands. The Bassendean Dunes generally have low relief; minor variations in topography translate into variable depths to watertable, which are the basis for division into soil mapping units. For example the Gavin soil has higher organic carbon content than all other soils sampled. The Spearwood Dunes are divided mainly on the depth of soil over the limestone substrate and the incidence of karst features. The Spearwood and Jandakot soils have lower coarse sand and lower carbon content, while the Karrakatta soils have the least amount of organic carbon. Detailed soil maps were compared with GIS-produced hydrogeomorphic maps. The results show that the distribution of HGUs in the catchment is controlled by the geological formations on which they were developed. The results also show that the hydrogeomorphic maps can be used in the absence of detailed soil maps to classify the catchment into areas that have similar soil characteristics. Filtering capacity of the soils is dependant on organic material, clays and other minerals. Based on these criteria, Spearwood Sands have the highest filtering capacity, followed by Bassendean and Quindalup.

THE GNANGARA MOUND is part of the Swan Coastal Plain which was formed mainly of depositional material either from fluvial or aeolian origin. The plain consists of a series of geomorphic entities, which are sub-parallel to the present coastline. The most easterly feature of the Mound is a series of laterite covered spurs forming the foothills of the Darling Scarp. Stretching from the foot of the hills is the relatively flat Pinjarra Plain built up of alluvium of varying ages. It is up to 13 km wide and is terminated sharply at its western edge by a series of coastal sand dunes: the Bassendean Dune System in the east, followed by the Spearwood Dune System, with the Quindalup Dune System fringing the present coastline (McArthur and Bettenay 1960).

The generalised surface geology of the study area is mainly based on the soils consisting of the Guildford clay in the east, the Bassendean and Spearwood sands in the middle, and the Tamala limestone and Safety Bay sand (Quindalup Dune System) on the beach.

The alluvial terrain includes the drainage system which discharges from the Gnangara Mound. The north and northeast drainage lines, which discharge into Gingin Brook, are mapped as Gingin Brook Complex (GG). The eastern drainage system towards Ellen Brook and the Swan River have been mapped as the Yanga unit (Ya).

Soils

The soil classification used in this study is summarised from McArthur and Bettenay (1960), and shown in Figure 1.

The Bassendean Dune System is generally of low relief with minor variations in topography; this means that the watertable is at variable depths, and this variation is the basis for division into soil mapping units. The landscape comprises 20 m high ridges and permanent open-water lakes. The flat or gently undulating terrain supporting Gavin soils (G) has less than

¹ CSIRO Land and Water, Private Bag No 5, PO Wembley, Western Australia 6913

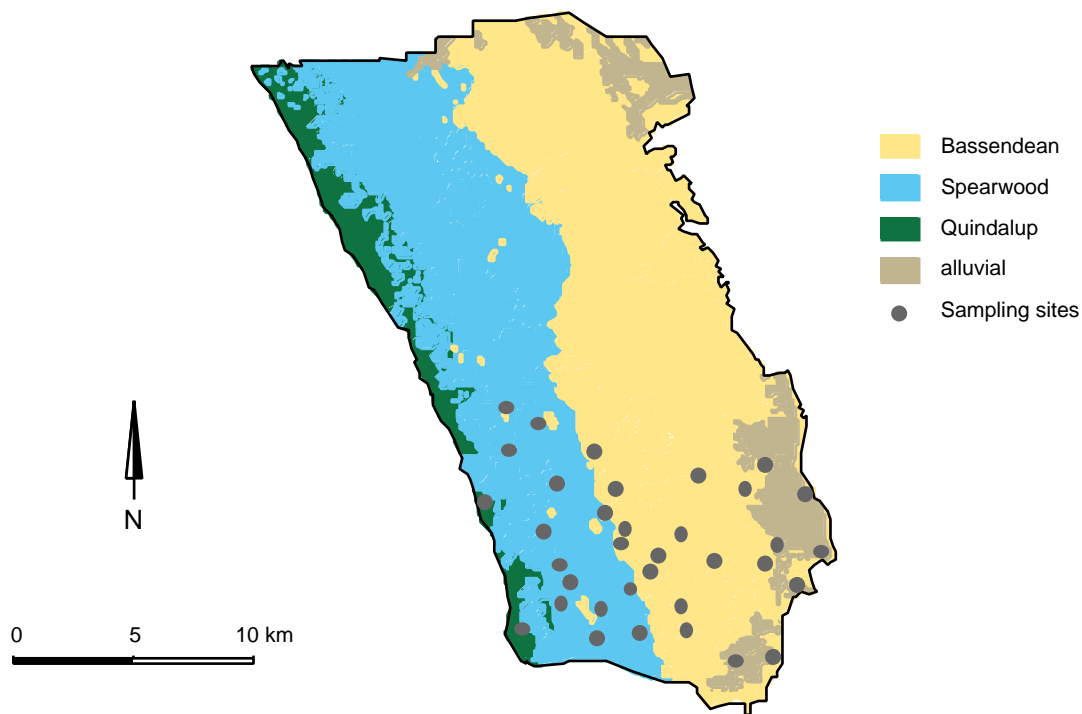

Figure 1. Gngangara Mound soils.

5 m relief. The hills and ridges (Jandakot soils (Ja) generally have more than 5 m relief, with one area of exceptionally high ridges mapped as Jandakot-Steep. The dunes probably accumulated as shoreline deposits and coastal dunes during interglacial periods of high sea-level and consist of lime sand, quartz sand and minor fine-grained, black, heavy mineral concentrations. The carbonate material has been completely leached, leaving dunes consisting entirely of quartz sand.

The Spearwood Dune System is classified mainly on the basis of depth of soil over the limestone substrate and the incidence of karst features. Limestone is exposed or covered with shallow soil (Limestone (Kls)) on the hills and ridges. In lower positions, the sand may be several metres thick and is mapped as the Karrakatta unit: the sand may be yellow almost to the surface (Karrakatta Yellow (Ky)), or grey in the surface layers (Karrakatta Grey (Kg)). In the karst depressions the slopes are mapped as Spearwood (Sp). The depressions often have permanent lakes (W) with poorly-drained areas, mapped as Beonaddy (B) around the edge.

The Quindalup Dune System occurs mainly west of the Wanneroo Road; the mapping units include

four phases (Q1–4), unstable sand (Qu), deep calcareous (Qp) and shallow calcareous (Qs).

Landuse

The three most common landuses in the Gngangara Mound are modified remnant vegetation, pine plantations, and market gardens (Figure 2 and Table 1). All three are major water users and either decrease the recharge to the aquifer (pines and reserves) or take water from the aquifer (agriculture), in addition to heavy abstraction by the Water Corporation for water supply and the thousands of wells used for domestic gardens. The minor landuses are water bodies and swamps (10 261 ha), drainage lines (2269 ha), and remnant vegetation (754 ha). This is in addition to the expanding urban areas which cover about 20 per cent of the Mound.

Modified remnant vegetation

An area of 86 000 ha is in natural reserves, in most cases slightly to moderately disturbed. This modified remnant vegetation is mainly in the Jandakot and Gavin sand ridges of the Bassendeane Dune System, and the Karrakatta, Limestone and Spearwood units of the Spearwood Dune System. *Banksia* spp. predominate, and the vegetation is largely open banksia woodland or low proteaceous and myrtaceous scrub on

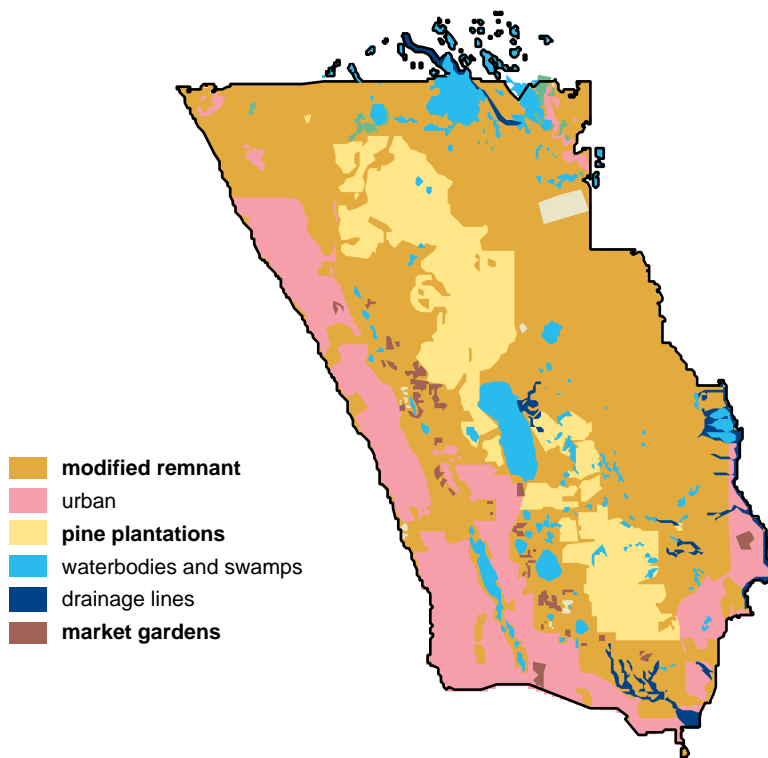

Figure 2. Gngangara Mound landuses.

limestone. It can be divided into two categories: species with deep roots; and species with shallow roots. The shallow-rooted species depend on the soil moisture in the profile, whereas the deep-rooted species may take part of their water from the capillary zone.

Pine plantations

An area of 24 000 ha has been established with pine plantations on the northern portions of the Swan Coastal Plain. The original land objectives were to produce saw-log timber for the Perth Metropolitan market.

Market gardens

The major agricultural activity in the Gngangara area is intensive horticulture (1925 ha), predominantly market gardens for vegetables, native and greenhouse flowers, citrus, avocados, stonefruit, grapevines, turf and nursery crops. It is an important market gardening area, due to its close proximity to metropolitan markets. It is a particularly significant growing area for broadleaf vegetables, and currently produces 58 per cent of the lettuce crop in Western Australia. Most production is on the sandy soils of the Bassendean and Spearwood Dune Systems.

Methodology

To study the leaching potential of the Gngangara soils to the most commonly-applied pesticides in the horticulture industry, 50 sites were selected for groundwater sampling and 21 for soil and water sampling and estimation of soil hydraulic parameters. The sites were selected to represent the three major landuses and the various management practices for the major soil-types: Gavin (G), Jandakot (Ja), Joel (J), Beonaddy (B), Karrakatta Grey (Kg), Karrakatta Limestone (Kls), Karrakatta Yellow (Ky), Spearwood (Sp).

Soil sampling

Soil samples were collected from topsoil (0–15 cm) and subsoil (40–50 cm), for the determination of physical and chemical properties of the soils. The topsoil samples were obtained with a hand trowel after removing any detritus and organic matter overburden; the subsoil samples were obtained by digging a 50 x 50 cm hole to the required depth, then using a hand trowel. The samples were placed into a strong plastic bag with most of the air removed and the bag sealed with PVC tape. The samples were well mixed

and divided into two halves, one for the determination of physical and hydraulic properties, the other for chemical and pesticide studies. Separate samples were also collected from each site for bulk density.

Table 1. Landuse in the southern Gngangara Mound.

Landuse	Area (ha)	Proportion (%)
Modified remnant	86 074	54.9
Urban	30 998	19.8
Pine Plantations	23 807	15.2
Water bodies & swamps	10 261	6.5
Drainage lines	2269	1.4
Market gardens	1925	1.2
Remnant	754	0.5
Unidentified	736	0.5
Totals	156 824	100.0

Particle-size distribution

Particle-size distribution was carried out using sieve analysis as recommended by the US Department of Agriculture (USDA). The soil was mixed thoroughly and a homogeneous sub-sample of about 200 g was placed in an air-forced drying cabinet for 12 hours at 52° C. The samples were sieved through a 2 mm sieve to remove any large organic matter, stones and gravel. The clean sample was passed through a set of five sieves for the following sizes: 1–2 mm (very coarse sand); 0.5–1.0 mm (coarse sand); 0.180–0.5 mm (medium sand); 0.063–0.180 mm (fine sand); and < 0.063 mm (silt and clay). Neither gravel nor stones were partitioned from any sample.

Soil-water retention

Soil water desorption data was obtained using the method described by Topp et al. (1993). Soil water retention for both topsoil and subsoil was determined for all soils. Soil moisture content, θ_g (gravimetric) and θ_v (volumetric), were obtained for the soils at five matric potentials: 0, -10, -30, -100, and -1500 kPa. Soils were air-dried at 52°C for 12 hours. The soil core rings had a fine nylon filter mesh material of ~90 μ m secured to the bottom of the ring. The ring was held down on a smooth surface, and then the outside of the ring was gently tapped to bring the dry soil to within approximate field-measured bulk density. The soils were then brought to saturation using de-aired tap water over three days at 21°C. The saturated soil samples were placed onto porous ceramic tension plates, covered and allowed to equilibrate at the different matric potentials applied. The matric potentials of -10 and -30 kPa were applied for seven days. The negative potential of -100 kPa was applied for ten days, whilst the negative potential of -1500 kPa was applied for 14 days.

Hydraulic conductivity

Hydraulic conductivity (Ksat) measurements were made using a ponded disc permeameter, (positive water potentials) fitted with a data logger to record the rate of drop of the water column. A stainless steel ring (4 cm deep x 20 cm diameter) was placed onto the clean-levelled soil surface and gently pressed half way into the soil. Two soil samples were taken from outside of the ring to determine initial soil moisture contents. The water-filled permeameter was placed on top of the ring and set to run. Two more soil samples were obtained from under the disc permeameter immediately after the water had left the soil surface. Logged data was used to determine K values for the soils. The hydraulic conductivity was calculated from the slope of the 'cumulative infiltration versus time' graph at early and late times as infiltration proceeded. Early infiltration was attributed to predominantly capillary behaviour (sorptivity). Gravity drainage was determined when the soil reached constant moisture content.

Bulk density

One bulk density sample was obtained from the top-soil and one from the subsoil using 50 x 47 mm stainless steel rings with chamfered outer edges to reduce friction. A spatula was used to level off the top and bottom surfaces, and the sample was gently tapped into a pre-weighed 250 ml tin can and sealed. Soil moisture contents were also obtained from these samples.

Organic carbon

A 200 g sub-sample was obtained from the bulk soil samples. These were then air-dried at 52°C for 12 hours and sieved through a 2 mm sieve. A 15 g sub-sample was removed, placed into a plastic vial and sealed. The analysis was conducted in the Western Australia Chemistry Centre using the Walkley and Black Method SO9.

Soil Characteristics

Water repellence occurs in the surface horizons of many acid coarse-textured soils. This phenomenon has been attributed to the coating of the sand particles with a skin of organic material. Dehydration of these skins during a hot dry summer cause them to become hydrophobic. This results in an uneven pattern of water infiltration at the start of the wet winter period. The continuous action of the raindrops removes the organic skin (Roberts and Carbon 1971).

The soils of the Gngangara Mound are mainly sandy soils (Table 2), with no gravel and generally <1.5 % very coarse sand (1.0–2.0 mm), 2–57 % coarse sand (0.5–1.0 mm), 20–78 % medium sand (0.18–0.5 mm),

Table 2. Particle-size analysis.

Site No.	Soil-type	Landuse	Sample Depth (cm)	Particle Size (%)				
				Very Coarse Sand (1.0–2.0 mm)	Coarse Sand (0.5–1.0 mm)	Medium Sand (0.180–0.5 mm)	Fine Sand (0.180–0.063 mm)	Silt+Clay (<0.063 mm)
1	J	Bb	0–15	0.15	18.57	72.90	7.29	1.62
			40–50	0.15	14.99	77.72	5.71	1.36
2	Ja	Bb	0–15	0.13	57.87	39.33	1.88	0.74
			40–50	0.16	49.29	48.24	1.73	0.25
3	G	Bb	0–15	0.56	47.14	46.17	4.78	0.87
			40–50	0.11	29.97	62.84	6.43	0.59
4	G	Mg	0–15	0.41	16.73	77.89	3.93	1.04
			40–50	0.23	12.08	82.02	5.05	0.68
5	B	Bb	0–15	1.27	45.05	47.15	5.31	1.13
			40–50	0.84	35.07	55.71	6.73	1.59
6	G	P	0–15	0.36	27.99	65.00	4.97	1.96
			40–50	0.12	19.74	74.39	4.26	1.36
7	Ky	Mg	0–15	0.72	59.97	35.58	2.71	1.03
			0–15	0.61	51.96	43.67	2.74	1.04
8	Sp	Mg	0–15	0.69	41.45	52.45	4.00	1.42
			40–50	0.33	37.19	59.21	2.49	0.82
9	Sp	Bb	0–15	0.76	28.92	63.82	5.02	1.34
			40–50	0.2	20.79	74.92	3.61	0.61
10	Ky	Bb	0–15	0.59	75.94	20.35	1.89	1.26
			40–50	0.47	65.70	30.79	2.01	1.16
11	Ja	Bb	0–15	0.39	30.11	65.46	3.16	0.10
			40–50	0.16	22.13	72.77	4.19	0.93
12	Sp	Mg	0–15	1.13	55.78	36.10	4.33	2.72
			40–50	0.91	45.75	44.84	6.93	1.07
13	Ky	Mg	0–15	1.50	33.68	49.01	12.23	3.78
			40–50	1.07	34.46	51.90	10.45	2.33
14	Kls	Mg	0–15	2.05	32.99	48.83	13.42	3.17
			40–50	1.52	22.94	54.54	18.62	2.61
15	J	Bb	0–15	0.52	54.50	41.39	2.72	1.02
			40–50	0.29	44.06	53.15	1.70	1.00
16	Ky	Mg	0–15	0.94	54.80	35.81	6.84	1.78
			40–50	0.86	50.79	39.78	6.94	1.80
17	G	P	0–15	0.57	44.23	51.26	2.79	1.48
			40–50	0.57	41.15	55.30	2.31	0.82
18	B	Mg	0–15	1.40	45.45	41.38	8.91	3.01
			40–50	1.48	49.12	40.85	6.51	1.96
19	Kls	Mg	0–15	1.13	46.94	45.27	5.21	1.52
			40–50	0.64	57.74	37.50	3.07	1.05
20	J	Bb	10	0.06	9.97	87.07	1.94	1.00
			200	0.15	5.07	91.53	3.04	0.49
			400	0.00	2.32	91.68	6.04	0.16
21	J	Mg	0–10	0.18	49.72	43.90	4.92	1.58
			40–50	0.26	48.96	45.02	4.17	1.43

Notes: Soil Systems & Types

Bassendean Dunes: G = Gavin, Ja = Jandakot, J = Joel

Spearwood Dunes: B = Beonaddy, Kg = Karrakatta Grey, Kls = Limestone, Ky = Karrakatta Yellow, Sp = Spearwood

Landuses

Bb = Banksia bush, P= pines, Mg = market gardens.

Table 3. Soil-water retention.

Site No.	Soil-type	Landuse	Sample Depth (cm)	Bulk Density (Dry, lab-packed) (g/cm ³)	Soil Moisture Content									
					Saturated Soil (0 kPa)	Field Capacity (-10 kPa)	-30 kPa	-100 kPa	Wilting point (-1500 kPa)					
				θ_g	θ_v	θ_g	θ_v	θ_g	θ_v	θ_g	θ_v			
1	J		0-15	1.25	0.41	0.52	0.40	0.50	0.26	0.33	0.10	0.13	0.06	0.08
		Bb	40-50	1.52	0.26	0.39	0.24	0.36	0.16	0.24	0.05	0.07	0.02	0.03
2	Ja		0-15	1.60	0.24	0.38	0.22	0.36	0.09	0.14	0.03	0.05	0.02	0.03
		Bb	40-50	1.64	0.22	0.35	0.20	0.32	0.05	0.09	0.01	0.02	0.01	0.01
3	G		0-15	1.57	0.33	0.45	0.34	0.46	0.16	0.21	0.07	0.09	0.05	0.07
		Bb	40-50	1.59	0.23	0.37	0.22	0.36	0.10	0.16	0.03	0.04	0.01	0.02
4	G		0-15	1.46	0.32	0.46	0.30	0.44	0.14	0.21	0.08	0.04	0.01	0.02
		Mg	40-50	1.59	0.25	0.40	0.23	0.37	0.11	0.18	0.02	0.03	0.01	0.01
5	B		0-15	1.34	0.38	0.51	0.35	0.46	0.16	0.21	0.08	0.10	0.06	0.08
		Bb	40-50	1.61	0.23	0.37	0.20	0.33	0.07	0.12	0.02	0.03	0.01	0.02
6	G		0-15	1.26	0.39	0.49	0.37	0.47	0.25	0.32	0.11	0.14	0.08	0.10
		P	40-50	1.50	0.27	0.40	0.25	0.37	0.09	0.14	0.03	0.05	0.02	0.03
7	Ky		0-15	1.54	0.25	0.39	0.22	0.34	0.06	0.10	0.03	0.05	0.02	0.03
		Mg	40-50	1.51	0.24	0.37	0.21	0.31	0.05	0.08	0.02	0.03	0.01	0.02
8	Sp		0-15	1.35	0.32	0.43	0.26	0.35	0.09	0.12	0.05	0.07	0.03	0.04
		Mg	40-50	1.34	0.28	0.38	0.25	0.30	0.07	0.09	0.03	0.04	0.01	0.02
9	Sp		0-15	1.43	0.34	0.49	0.31	0.44	0.19	0.27	0.08	0.11	0.06	0.09
		Bb	40-50	1.51	0.26	0.40	0.23	0.35	0.08	0.13	0.02	0.04	0.01	0.02
10	Ky		0-15	1.46	0.28	0.41	0.23	0.34	0.07	0.10	0.04	0.06	0.02	0.03
		Bb	40-50	1.54	0.26	0.41	0.23	0.35	0.06	0.09	0.03	0.04	0.01	0.02
11	Ja		0-15	1.37	0.30	0.41	0.28	0.38	0.12	0.16	0.05	0.06	0.02	0.03
		Bb	40-50	1.55	0.24	0.37	0.23	0.36	0.10	0.16	0.02	0.04	0.01	0.01
12	Mg		0-15	1.50	0.26	0.38	0.21	0.31	0.09	0.14	0.06	0.09	0.02	0.03
		Sp	40-50	1.52	0.26	0.40	0.22	0.33	0.08	0.12	0.04	0.05	0.01	0.02
13	Ky		0-15	1.60	0.23	0.36	0.21	0.33	0.16	0.25	0.08	0.12	0.03	0.04
		Mg	40-50	1.48	0.28	0.42	0.25	0.38	0.17	0.26	0.07	0.10	0.03	0.04
14	Kls		0-15	1.51	0.26	0.39	0.22	0.33	0.15	0.22	0.07	0.11	0.02	0.03
		Mg	40-50	1.54	0.25	0.39	0.22	0.34	0.14	0.22	0.04	0.06	0.02	0.03
15	J		0-15	1.27	0.37	0.47	0.32	0.40	0.14	0.17	0.06	0.08	0.05	0.06
		Bb	40-50	1.57	0.24	0.38	0.23	0.36	0.06	0.10	0.03	0.04	0.01	0.02
16	Ky		0-15	1.42	0.30	0.42	0.26	0.37	0.11	0.16	0.08	0.10	0.03	0.04
		Mg	40-50	1.56	0.25	0.38	0.22	0.34	0.07	0.11	0.03	0.05	0.01	0.02
17	G		0-15	1.30	0.36	0.47	0.31	0.41	0.15	0.19	0.13	0.17	0.05	0.06
		P	40-50	1.58	0.23	0.37	0.22	0.35	0.07	0.12	0.02	0.03	0.01	0.02
18	B		0-15	1.28	0.34	0.44	0.32	0.41	0.22	0.28	0.15	0.17	0.06	0.08
		Mg	40-50	1.13	0.48	0.55	0.44	0.50	0.26	0.30	0.16	0.18	0.10	0.11
19	Kls		0-15	1.36	0.32	0.43	0.28	0.38	0.13	0.18	0.06	0.08	0.04	0.05
		Mg	40-50	1.52	0.27	0.41	0.23	0.35	0.08	0.12	0.03	0.05	0.02	0.03
20	J		10	1.57	0.24	0.38	0.24	0.38	0.11	0.17	0.03	0.05	0.03	0.05
		Bb	200	1.56	0.26	0.41	0.26	0.40	0.18	0.28	0.03	0.04	0.01	0.02
		Mg	400	1.63	0.23	0.37	0.25	0.37	0.18	0.29	0.03	0.04	0.01	0.02
21	J		0-10	1.61	0.24	0.39	0.23	0.37	0.08	0.13	0.04	0.06	0.02	0.03
		Mg	40-50	1.78	0.19	0.33	0.17	0.31	0.09	0.16	0.03	0.05	0.02	0.03

Notes: **Soil Systems & Types** Bassendean Dunes: G = Gavin, Ja = Jandakot, J = Joel, Spearwood Dunes: B = Beonaddy, Kg = Karrakatta Grey, Kls = Limestone, Ky = Karrakatta Yellow, Sp = Spearwood

Landuses Bb = Banksia bush, P = pines, Mg = market gardens

Soil moisture content measurement methods θ_g = by weight of soil solids (gravimetric), θ_v = per volume of soil (volumetric).

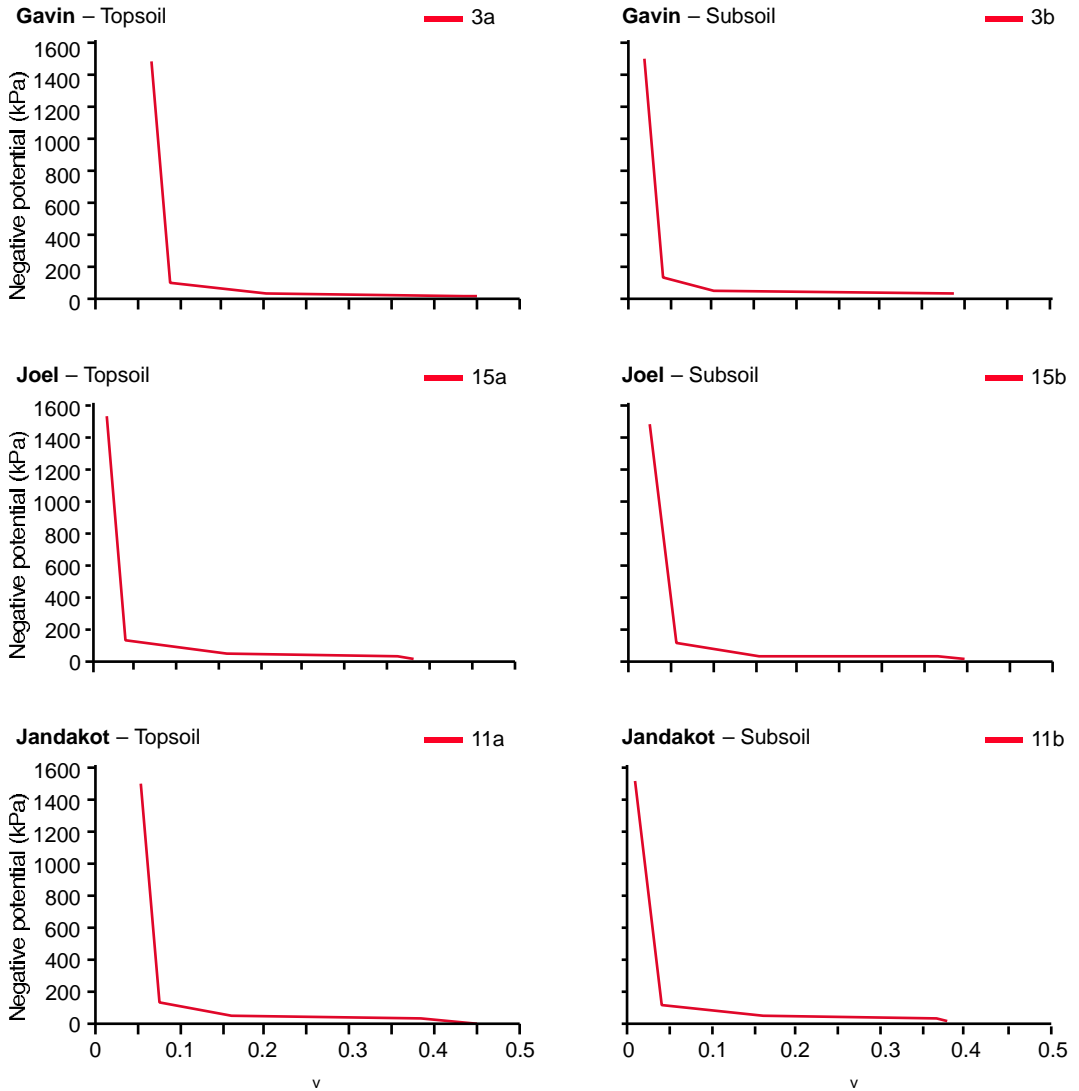

Figure 3a. Soil moisture retention (Bassendean soils).

1.7–18 % fine sand (0.063–0.18 mm), and <1.0–4 % of silt and clay (<0.063 mm). The Bassendean soils are characterised by higher percentages of coarse and medium sands, while the Spearwood soils have higher percentages of fine sand.

Soil-water retention

The soil moisture characteristic curve is strongly related to the soil texture. The greater the clay content, the greater the water retention at a particular suction. Since the Gnangara soils are mainly sandy, with relatively large pore space and low water potential (Table 3), the retention curve falls sharply with suction (Figure 3). The curves also indicate that the

soils are not compacted. Sands from the Spearwood Dune System have very little capacity to store water. Both the soil-water potential and the soil hydraulic conductivity fell rapidly with small decreases in water content. Similar results were reported earlier by Carbon et al. 1982.

Organic carbon

The organic carbon content (OC) in the Bassendean sands ranged from 0.86 per cent in clear land to 4.8 per cent in some areas under pines for the topsoil (0–10 cm); in the subsoil (40–50 cm) OC was much lower at 0.09–0.89 per cent (Table 4). In the Spearwood sand, OC was 0.57–2.5 per cent in the

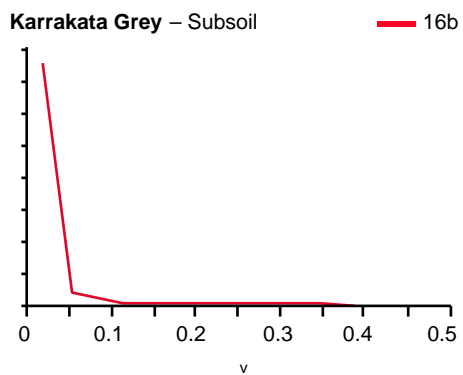
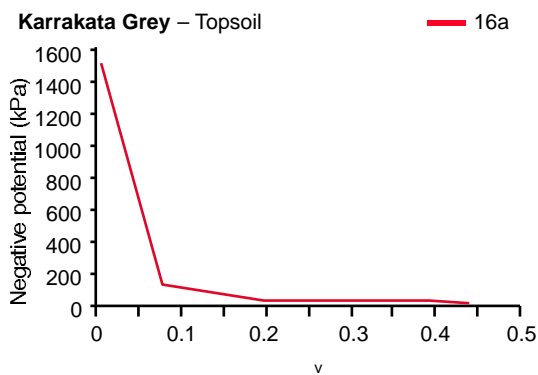
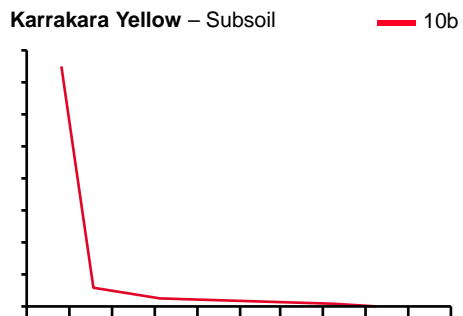
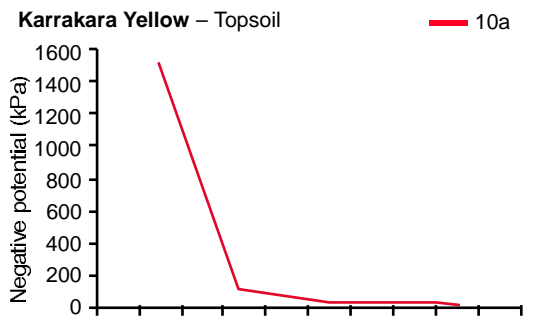
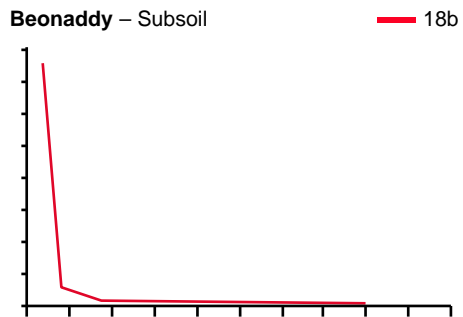
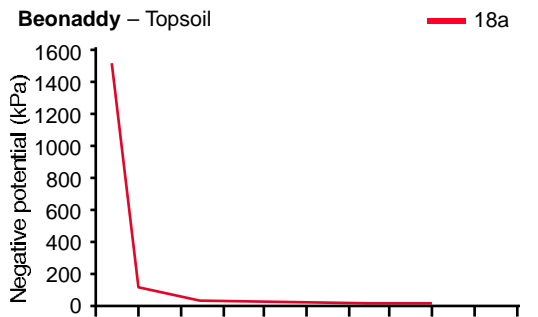
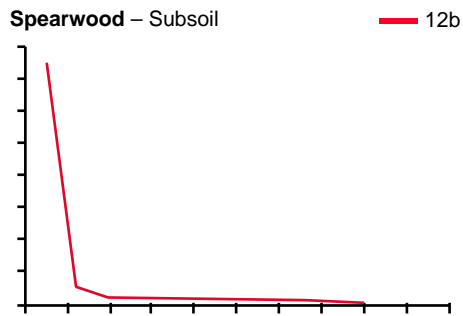
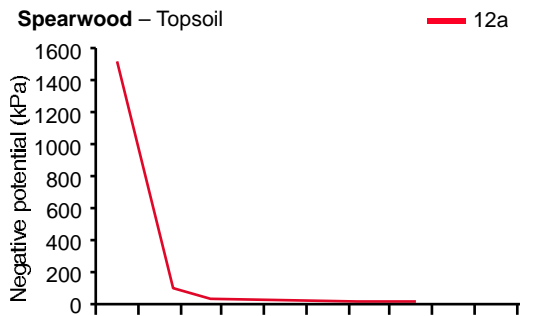

Figure 3b. Soil moisture retention (Spearwood soils).

Table 4. Soil physical properties.

Site No.	Soil-type	Landuse	Sample Depth (cm)	Organic Carbon (%)	Dry-soil Bulk Density (g/cm ³)	Porosity, E 1-(bd/2.65)	pH	Electrical Conductivity (mS/cm)
1	J	Bb	0–15	2.90	1.23	0.54	4.64	0.0237
			40–50	0.89	1.49	0.44	4.51	0.0081
2	Ja	Bb	0–15	1.02	1.46	0.45	5.00	0.0094
			40–50	0.14	1.60	0.40	5.12	0.0049
3	G	Bb	0–15	2.94	1.48	0.44	4.92	0.0389
			40–50	0.56	1.54	0.42	4.93	0.0135
4	G	Mg	0–15	1.05	1.53	0.42	4.43	0.0406
			40–50	0.09	1.55	0.42	4.39	0.0106
5	B	Bb	0–15	2.88	1.05	0.60	5.96	0.0479
			40–50	0.18	1.55	0.41	5.50	0.0199
6	G	P	0–15	4.80	1.03	0.61	4.46	0.0235
			40–50	0.66	1.49	0.44	3.91	0.0221
7	Ky	Mg	0–15	0.57	1.32	0.50	6.24	0.0354
			0–15	0.10	1.62	0.39	6.38	0.0157
8	Sp	Mg	0–15	0.78	1.45	0.45	5.61	0.0462
			40–50	0.16	1.51	0.43	6.18	0.0219
9	Sp	Bb	0–15	2.50	1.22	0.54	6.08	0.0763
			40–50	0.25	1.56	0.41	6.14	0.0239
10	Ky	Bb	0–15	0.75	1.47	0.44	5.52	0.0232
			40–50	0.28	1.54	0.42	5.62	0.0156
11	Ja	Bb	0–15	1.02	1.39	0.47	4.83	0.0220
			40–50	0.34	1.61	0.39	4.64	0.0063
12	Sp	Mg	0–1	0.85	1.64	0.38	7.19	0.0486
			40–50	0.24	1.55	0.41	7.28	0.0208
13	Ky	Mg	0–15	0.82	1.39	0.48	7.02	0.0408
			40–50	0.49	1.57	0.41	6.70	0.0389
14	Kls	Mg	0–15	0.78	1.28	0.52	7.05	0.0539
			40–50	0.29	1.56	0.41	7.15	0.0354
15	J	B	0–15	1.14	1.30	0.51	4.53	0.0166
			40–50	0.84	1.59	0.40	4.65	0.0057
16	Ky	Mg	0–15	1.13	1.49	0.44	7.00	0.0231
			40–50	0.31	1.45	0.45	7.14	0.0541
17	G	P	0–15	2.17	1.20	0.55	5.97	0.0355
			40–50	0.45	1.39	0.47	4.90	0.0177
18	B	Mg	0–15	2.16	1.48	0.44	7.16	0.0957
			40–50	3.08	1.21	0.54	7.90	0.1752
19	Kls	Mg	0–15	1.05	1.39	0.48	7.87	0.0709
			40–50	0.48	1.60	0.40	7.81	0.0588
20	J	Bb	10	0.86	1.49	0.44	4.87	0.0150
			200	0.50	1.63	0.38	5.46	0.0055
			400	0.10	1.60	0.40	5.20	0.0045
21	J	Mg	0–10	0.58	1.66	0.37	6.58	0.0575
			40–50	0.16	1.63	0.38	5.83	0.0362

Notes: Soil Systems & Types

Bassendeau Dunes: G= Gavin, Ja = Jandakot, J = Joel

Spearwood Dunes: B = Beonaddy, Kg = Karrakatta Grey, Kls = Limestone, Ky = Karrakatta Yellow, Sp = Spearwood

Landuses

Bb = Banksia bush, P= pines, Mg = market gardens.

Table 5. Hydraulic conductivity of Gnangara soils.

Site No.	Soil-type	Landuse	Sample Depth (cm)	Hydraulic Conductivity, K (m/day)
1	J	Bb	0–15	0.63
			40–50	4.26
2	Ja	Bb	0–15	1.40
			40–50	5.00
3	G	Bb	0–15	1.54
			40–50	0.41
4	G	Mg	0–15	1.12
			40–50	1.46
5	B	Bb	0–15	5.20
			40–50	3.55
6	G	P	0–15	2.32
			40–50	0.95
7	Ky	Mg	0–15	7.30
			0–15	5.33
8	Sp	Mg	0–15	3.57
			40–50	4.06
9	Sp	Bb	0–15	0.42
			40–50	3.56
10	Ky	Bb	0–15	1.26
			40–50	5.69
11	J	Bb	0–15	0.57
			40–50	5.27
12	Sp	Mg	0–15	2.99
			40–50	2.99
13	Ky	Mg	0–15	2.78
			40–50	1.82
14	Kls	Mg	0–15	4.23
			40–50	2.26
15	J	Bb	0–15	1.86
			40–50	3.30
16	Ky	Mg	0–15	2.26
			40–50	5.06
17	G	P	0–15	2.67
			40–50	7.21
18	B	Mg	0–15	2.05
			40–50	0.38
19	Kls	Mg	0–15	6.38
			40–50	4.41
20	J	Bb	10	4.75
			200	3.94
			400	3.67
21	J	Mg	0–10	1.48
			40–50	3.09

Note: Soil systems, soil-types and landuses as for Table 4.

topsoil (0–10 cm), and 0.1 to 0.82 in the subsoil. In the Beonaddy soils, which are associated with swampy regions, OC was higher ranging from 2.16 per cent in the topsoil to 3.0 per cent in the subsoil.

Hydraulic conductivity

Hydraulic conductivity measurements were carried out at 21 sites, at two depth intervals, using topsoils (0–10 cm) and subsoils (40–50 cm) (Table 5). The results of the first set of measurement of hydraulic conductivity gave comparatively lower values than the ones recorded in the literature (Carbon 1973), so a repeat of the test was made at all sites. The results from both tests were identical and showed that the hydraulic conductivities were low. The results also show that the hydraulic conductivity of the topsoil is lower than the subsoil. Although the Bassendean sands have higher hydraulic conductivities, the results also show that there are not big differences in the hydraulic conductivity between the Bassendean and the Spearwood sands. Hydraulic conductivity ranges from 0.56 to 2.85 m/day for the topsoils and 3.41 to 6.38 m/day in the subsoils.

Geomorphological mapping

Landform reflects the combined effects of the hydrological, erosional and depositional processes which take place in an area. Given similar cover and climatic conditions, lithology and soil characteristics control the rate of infiltration. A change of lithology within a slope is often reflected in the slope form, which in turn will affect surface processes as the slope configuration becomes more complex.

Recent advances in the capabilities of geographic information systems (GIS) in collating and processing spatial data have revolutionised mapping concepts. It is now possible to produce maps objectively and produce dynamic geomorphic maps using GIS-based analytical and modelling capabilities to manipulate spatial data to any required scale and for any configuration or combination of attributes such as slope, aspect and curvature. This makes static mapping obsolete. The objectives of geomorphological mapping can be summarised as:

- identify similar areas in the landscape that have similar topographic characteristics
- use these units as the basis for the hydrogeomorphic mapping
- model the hydrogeomorphic map to provide a systematic basis for the derivation of more complex hydrogeological units.

Discussion

Comparison of soil landscape with geomorphological mapping, and its relationship with soil genesis

The great Mindel-Riss Interglacial epoch occurred about 240 000 years ago. Maximum sea-level during the Riss-Wurm Interglacial has been put at about 8m higher than the present day, with some estimates as high as double that (McArthur and Bettenay 1960). It has been suggested that deposition to form the Pinjara Plain as it is today began with the retreat of the sea following the Mindel-Riss Interglacial. The Bassendean dune system, the oldest of the three dune systems, may have begun at the RissI-RissII Interstadial; however, the main accumulation took place in the Riss-Wurm interglacial period over 100 000 years. Following the Bassendean dunes, there was apparently a considerable break before the accumulation of the Spearwood dune system, which is totally different in topography and composition and must be regarded as very youthful by comparison. Accumulation of this system began in the Wurm I Interstadial. The Quindalup dune system is associated with a falling sea-level. The relatively young age of the dune systems suggest that several interrelated processes of weathering which took place since their deposition are still ongoing today.

The geomorphology of the Ngarara Mound may be depicted as consisting of the degraded surface of aeolian origin of the Bassendean Dunes in the east and the Spearwood Dunes in the west, with pockets of parabolic and nested-parabolic dune complex (Quindalup dunes) along the shore. This geomorphological classification can be mechanically performed using GIS techniques by classifying the elevation (from digital elevation data) into three main divisions and superimposing the highly undulating Quindalup along the shoreline. The Quindalup can be distinguished in the GIS by its characteristic form and slope pattern.

Table 6. Hydrogeomorphic units corresponding to the soil-types.

Soil-type	Hydrogeomorphic Units (HGU)
Gavin	61,62,71
Jandakot	72,82,83,91,92,93
Beonaddy	12
Karrakatta	43,53,63
Limestone/Spearwood	22,32,33
Quindalup	11,23,24
alluvial	41,42
waterbodies & swamps	51,52

A detailed classification of the hydrogeomorphic elements used for this study is based on nine elevation classes (10, 20, ..., 80 and >80 m) and three slope classes (<0.4°, 0.4–1.8° and 3.0–1.8°). This resulted in 27 hydrogeomorphic elements, which were correlated with the units of the soil maps. The final map was prepared by combining similar elements based on either similar elevation or similar slopes to reduce the number of elements. This was achieved by giving similar colours to the assigned units. This resulted in eight hydrogeomorphic units as shown in Table 6. The hydrogeomorphic unit (HGU) map is shown as Figure 4.

The soils of the Bassendean Dunes are Podsoles, those of the Spearwood Dunes are podsolised sands, and the Quindalup Dunes are undifferentiated calcareous sands. In the most easterly and oldest parts of the Bassendean Dunes, the humus podsoles, typified by the Gavin series, are dominant. Proceeding westward, the incidence of iron-humus podsoles (Jandakot series) becomes higher. In the Spearwood Dunes, the depth of sand overlying aeolianites is greater on the eastern edge (Karrakatta series) and show a well-defined lower horizon within the topsoil. In the Quindalup System, there is more uniform carbonate near the shore and concentration of carbonate in the lower horizons (McArthur and Bettenay 1960).

Lakes, swamps and low-lying areas mapped by the hydrogeomorphic techniques looked similar to the existing features; the main differences were associated with the undulating Spearwood and the lower ranges of the Bassendean. Due to similar elevation ranges in parts of the Spearwood were mapped as Bassendean. Similar problems are associated with the low-lying areas in the Spearwood which were within ranges of the same elevation as those in the alluvial area in the eastern parts of the catchment.

The results of the mapping show that the distribution of hydrogeomorphic units (HGUs) in the catchment is controlled by the geological formations on which they were developed. The weathering characteristics of each of the geological formations led to the development of a certain HGU. For example, the Bassendean sands are developed in the higher parts of the landscape, and the Spearwood sands are developed at the break of slope of the Bassendean sands. The series of lakes extending in the north-south line are also at the break of slope. The Quindalup sands near the shore are characterised by parabolic and nested-parabolic dune complexes. At the same time, slope, break of slope and curvature control where groundwater will discharge. In most cases, this coincided with the series of lakes and swamps that extend along the north-south line within the Spearwood sands.

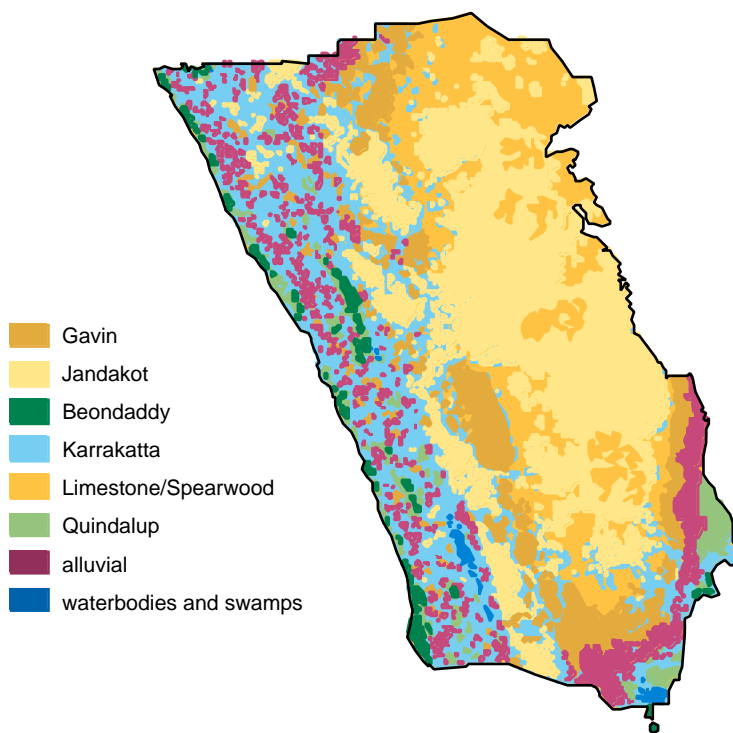

Figure 4. Gngangara Mound HGUs.

Soil characteristics of the Gngangara Mound that control pesticide leaching

Pesticide sorption in soils is dependent on both the type of pesticide and the physical and chemical characteristics of soils, including the types of minerals present. The thickness of soils, especially the topsoil which contains most of the organic matter and biota, determine the length of travel time that the contaminants will take to pass through this layer. Organic material, clays and other minerals react with the contaminants to absorb, react with or volatilise the chemicals. The soil physical characteristics and hydraulic properties influence the rate at which water infiltrates through the soil profile. Based on this, Bassendean sands would have lower filtering capacity than Spearwood sands. The Quindalup sands would have the lowest filtering capacity, especially in areas with shallow soil cover underlain by limestone. Two other important soil factors controlling the interactions are soil pH and soil solution composition.

Pesticide-organic matter interaction

Interaction between pesticides and soil organic matter occurs in two main ways: specific interaction between soil organic matter and pesticides leading to the formation of definite bonding and partitioning and formation of new compounds; and physical sorption

leading to the formation of thermodynamically-stable compounds. In tropical soils that are generally low in organic carbon, both the clay fraction and organic carbon may play an important role in controlling pesticide sorption.

The Gavin soils have high filtration potential due to the relatively high organic carbon content. The Spearwood and Jandakot sands have lower filtration capacity due to their lower carbon content and the Karrakatta soils have the least capacity for filtering pesticides due to their very low carbon content.

Soil pH

McArthur and Bettenay (1960) summarised the changes that occur in soils of the dune system with continued leaching of a highly calcareous sand. Progressive loss of carbonate, first from the surface and then completely, took place over 100 000–200 000 years. The losses of carbonate lead to a two-unit fall in pH and an increase in the calcium/magnesium ratio in the residual aeolinite. There is progressive loss of iron with more effective removal in the wetter and less-drained areas. After the complete removal of carbonate, an organic lower horizon develops and the pH falls by a further unit.

Beside the difference in organic carbon with soil-type, there are also marked differences due to

landuse. The soils under market gardens were near neutral pH, whereas those under natural vegetation were generally acidic in reaction, with some as low as pH 4. Soil pH effects are important with weakly basic (triazine) and acidic (phenoxy acid) pesticides because the relative quantities in ionic form are dependent on the pK of the pesticide and pH of the soil system. Weakly basic pesticides become cations at low pH. In variable charge soils, such pH values lead to low surface negative charge and high positive charge that result in increased sorption. In contrast, the acidic pesticides ionise to anionic form as pH increases (one or more pH units above the pKa of acid) (Weber 1993). There are some reports of increasing sorption of some pesticides with decreasing pH, as is the case in this study in the topsoils under native vegetation and pines.

Soil solution composition

Interaction between contaminants and soil particles takes place at the solid-solution interface. Thus the water content of the soil and chemistry of the soil water influence the solubility of the pesticides, interaction with the chemicals and minerals in the water, and the rate with which the interstitial water is moving downward or laterally, or both.

The soils and interstitial water in the Quindalup and Spearwood Sand systems are mainly high in pH and in alkaline material, whilst the Bassendean Sands are lower in pH. Weakly basic pesticides become cations at low pH; such pH values lead to low surface negative charge and high surface positive charge resulting in increased sorption. On the other hand, the acidic pesticides ionise to anionic form as pH increases, and this may lead to reduced sorption with increasing pH.

Conclusions

Physical, chemical and hydraulic characteristics of topsoil (0–15 cm) and subsoil (40–50 cm) were carried out at 21 sites in the southern part of the Gnangara Mound, representing the major soils under the different landuse in the area. The results show that Bassendean Sands have higher coarse sand particles and consequently higher hydraulic conductivity than Spearwood Sands. The Bassendean Dunes generally have low relief; minor variations in topography translate into variable depths to watertable, which are the basis for division into soil mapping units. For example the Gavin soil has higher organic carbon content than all other soils sampled. The Spearwood Dunes are divided mainly on the depth of soil over the limestone substrate and the incidence of karst features.

The Spearwood and Jandakot soils have lower coarse sand and lower carbon content, while the Karrakatta soils have the least amount of organic carbon.

Detailed soil maps were compared with GIS-produced hydrogeomorphic maps. The results show that the hydrogeomorphic maps can be used in the absence of detailed soil maps to classify the catchment into areas with similar soil characteristics.

Filtering capacity of the soils is dependant on organic material, clays and other minerals. Based on these criteria, Spearwood Sands have the highest filtering capacity, followed by Bassendean and Quindalup.

References

- Carbon, B.A. 1973. Some aspects of soil-plant water relations in a coarse soil. MSc Thesis, University of Western Australia.
- Carbon, B.A., Roberts, F.J., Farrington, P. and Beresford, J.D. 1982. Deep drainage and water use of forests and pastures grown on deep sands in a Mediterranean environment. *Journal of Hydrology* 55: 53–64.
- McArthur, W.M. and Bettenay, E. 1960. The development and distribution of the soils of the Swan Coastal Plain, Western Australia. Soil Publication No 16, CSIRO, Melbourne.
- Roberts, F.J. and Carbon, B.A. 1971. Water repellence in sandy soils of south-western Australia. 1. Some studies related to field occurrence. *Field Station Record*. CSIRO Division of Plant Industry: 13–20.
- Topp, G.C., Galganov, Y.T., Ball, B.C. and Carter, M.R. 1993. Soil water desorption curves. *In*: Carter, M.R., ed., *Soil Sampling and Methods of Analysis*. Lewis Publishers, Florida: 569–580.
- Weber, J.B. 1993. Ionization and sorption of fomesafen and atrazine by soils and soil constituents. *Pesticide Science* 39: 31–38.
- White, R.E. 1997. *Principles and Practice of Soil Science: The Soil as a Natural Resource*. 3rd ed. Blackwell Science, Oxford.

Sorption of Selected Pesticides and their Metabolites in Soil Profiles of the Swan Coastal Plain

R.S. Kookana¹, A. Kerekes¹, D. Oliver¹, R.B. Salama² and J.D. Byrne²

Abstract

A study was conducted to estimate the sorption of nine different pesticides in 23 soils of the Swan Coastal Plain of Western Australia. Surface and sub-surface soils were collected from several sites under native vegetation (*Banksia* woodland) and under market gardens around Perth. Sorption was measured by a batch equilibration method employing a single-solution concentration. The sorption coefficients (K_d) were calculated assuming a linear relation between solution and sorbed concentrations. The pesticides studied included atrazine and its two main metabolites (desethylatrazine and desisopropylatrazine), fenamiphos and its two main metabolites (sulfoxide and sulfone), fenarimol, azinphos methyl and prometryn. The soils studied showed a wide range of sorption capacities for pesticides. While a general trend of higher sorption with higher organic matter content of the soil was apparent, organic carbon alone could not explain the differences. The metabolites of atrazine and fenamiphos had much lower sorption affinities for soils than their respective parent compounds. The metabolites of fenamiphos had an order-of-magnitude lower sorption than their parent compound in some soils. Given that these metabolites are equally toxic in nature and more persistent than their parent compounds, the potential of the metabolites themselves to pollute groundwater should be taken into account. For most soils the K_d values for desisopropylatrazine were the lowest, and azinphos methyl the highest. The pesticides in descending order of sorption were: azinphos methyl > fenarimol > prometryn > fenamiphos > atrazine > fenamiphos sulfone > fenamiphos sulfoxide > desethylatrazine > desisopropylatrazine. The sorption per unit mass of organic carbon in soils (K_{oc}) showed a wide variation among the soils studied, possibly reflecting the varying nature of organic materials present in the soils. The sorption coefficients for pesticides were much lower in subsoils than in surface soils; in some cases they were negligible in subsoils. This suggests that in such soils, once the pesticide leaches beyond the top 50–100 cm, it can move with the water-front with little retardation through sorption.

INTENSIVE AGRICULTURE relies heavily on the use of pesticides to control weeds, insect pests and diseases. Continuous use of pesticides has caused contamination of surface and ground water in several parts of the world, including Australia (Vighi and Funari 1995; Kookana, Phang and Aylmore 1997). A recent monitoring study on groundwaters of several regions of Australia has revealed the presence of pesticide residues at trace levels (Bauld 1996). This is of concern to the community, especially in areas where groundwater is used for drinking or domestic use. Several rural and urban centres of Australia rely heavily on groundwater for drinking purposes. For example, nearly two thirds of the drinking water

supply in metropolitan Perth is extracted from groundwater. It is therefore imperative that such groundwater sources are protected from contamination.

Pesticides are commonly used for vegetable production, often with several applications, in the market gardens on the Gnangara Mound in the Swan Coastal Plain. This study was carried out to assess the mobility of pesticides through selected soil profiles of the area. Sorption is a key factor in controlling pesticide move-

¹ CSIRO Land and Water, Private Bag No 2, Glen Osmond, South Australia 5064

² CSIRO Land and Water, Private Bag No 5, PO Wembley, Western Australia 6913

ment through soils to the groundwater. The study objectives were therefore to:

- estimate the extent of sorption of commonly-used pesticides, through profiles representing different soil-types in the area, and
- provide the sorption coefficient as an input parameter for the assessment of groundwater vulnerability in the Swan Coastal Plain.

Materials and Methods

Soils

Twenty-three surface and sub-surface soils were sampled from 11 sites in the Gnangara Mound. The samples were mostly taken at 0–15 or 40–50 cm, and one site required sampling at 200 and 400 cm. The soils were air-dried, ground and sieved through a 2 mm sieve before determining their physico-chemical properties. The properties of the soil profiles are shown in Table 1. From the point of view of sorption of pesticides to soil, the key soil property is the organic carbon content (OC). As expected, OCs of sub-surface layers were much lower than those of the

surface layers (in some cases down to ten per cent). The soils under intensive horticulture (market gardens) had lower OC than those under native vegetation. The other key difference among soils was the pH. The soils under market gardens were near neutral, whereas those under natural vegetation were generally acidic with some as low as pH 4.

Pesticides

The pesticides in the sorption study were selected from the list of commonly-used pesticides on the basis of their persistence and likely pollution potential for the groundwater in the study area. They were, as shown in Table 2:

- atrazine (and its two main metabolites desethylatrazine (DEA) and desisopropylatrazine (DIA))
- fenamiphos (and its two main metabolites fenamiphos sulfoxide (FS) and fenamiphos sulfone (FSO))
- fenarimol
- azinphos methyl
- prometryn.

Table 1. Physical and chemical properties of the soils used in the study.

Sample No.	Site No.	Soil-type	Landuse	Sample Depth (cm)	OC (%)	Dry-soil Bulk Density (g/cm)	Porosity, E (1-(bd/2.65))	pH	Electrical Conductivity (mS/cm)
1	1	J	Bb	0–15	2.90	1.23	0.54	4.64	0.0237
2				40–50	0.89	1.49	0.44	4.51	0.0081
3	2	Ja	Bb	0–15	1.02	1.46	0.45	5.00	0.0094
4				40–50	0.14	1.60	0.40	5.12	0.0049
5	3	G	Bb	0–15	2.94	1.48	0.44	4.92	0.0389
6				40–50	0.56	1.54	0.42	4.93	0.0135
7	6	G	P	0–15	4.80	1.03	0.61	4.46	0.0235
8				40–50	0.66	1.49	0.44	3.91	0.0221
9	9	Sp	Bb	0–15	2.50	1.22	0.54	6.08	0.0763
10				40–50	0.25	1.56	0.41	6.14	0.0239
11	13	Ky	Mg	0–15	0.82	1.39	0.48	7.02	0.0408
12				40–50	0.49	1.57	0.41	6.74	0.0389
13	15	J	Bb	0–15	1.14	1.30	0.51	4.53	0.0166
14				40–50	0.84	1.59	0.40	4.65	0.0057
15	16	Ky	Mg	0–15	1.13	1.49	0.44	7.00	0.0231
16				40–50	0.31	1.45	0.45	7.14	0.0541
17	18	B	Mg	0–15	2.16	1.48	0.44	7.16	0.0957
18				40–50	3.08	1.21	0.54	7.94	0.1752
19	19	Kls	Mg	0–15	1.05	1.39	0.48	7.87	0.0709
20				40–50	0.48	1.60	0.40	7.81	0.0588
21	20	J	Bb	10	0.86	1.49	0.44	4.87	0.0150
22				200	0.50	1.63	0.38	5.46	0.0055
23				400	0.10	1.60	0.40	5.20	0.0045

Notes: Soil Systems & Types

Bassendean Dunes: G= Gavin, Ja = Jandakot, J = Joel

Spearwood Dunes: B = Beonaddy, Kg = Karrakatta Grey, Kls = Limestone, Ky = Karrakatta Yellow, Sp = Spearwood

Landuses

Bb = Banksia bush, P= pines, Mg = market gardens.

Table 2. Key properties of the pesticides used in this study (metabolites not shown).

Common name	Class	pKa	Solubility at 25°C (mg/L)	Half-life (days)	Log K_{ow}
atrazine	s-triazine herbicide	1.68	33	60	2.50
fenamiphos	organophosphate insecticide and nematocide	–	400	50	3.30
fenarimol	fungicide	–	4	360	3.69
azinphos methyl	organophosphate insecticide	–	29	10	2.96
prometryn	s-triazine herbicide	4.05	33	60	3.10

Note: half-life calculations after Wauchope et al. 1992.

Sorption measurement

Due to the large number of soils studied, a single-point sorption measurement was made as an approximate measure of pesticide sorption. The sorption coefficient (Kd) was calculated from the ratio of sorbed concentration to the soil solution concentration after equilibration. The soils were weighed out in triplicate (5 g) into centrifuge tubes, and to each tube was added 10 ml of 0.005M Ca(NO₃)₂ solution spiked with a known concentration of pesticide. The single concentration used during the sorption study for all pesticides was 2 mg/L. Soil suspensions in the centrifuge tubes were shaken for four hours on an end-over-end shaker, then centrifuged at 2000 rpm for five minutes before the supernatant was decanted. The supernatant was filtered through 0.45 µm acrodisk filters, then analysed on a High Performance Liquid Chromatograph (HPLC).

Pesticide analysis

The concentrations of pesticides in the supernatants after equilibration were measured on a Varian HPLC equipped with a Star 9012 ternary gradient pump, Polychrom 9065 diode array detector (PDA), Star 9050 programmable variable-wavelength UV detector, an auto-injector, column oven, and a Star 9100 auto-sampler with electric sample valve. Data were collected and processed on the Star HPLC data system.

Atrazine and metabolites (DEA and DIA) and azinphos methyl

Waters radial pak liquid chromatography C₁₈ cartridges (10 cm x 5 mm ID, 4 µm particle size); gradient elution with mobile phase 90:10 H₂O:CH₃CN for first two minutes, which then changes over for the following five minutes to 50:50 H₂O:CH₃CN and is maintained at this composition for the next eight minutes; flow rate 1.0 mL/min; UV-Vis detector wavelength 220 nm; retention times: DEA, 6.2 minutes; DIA, 7.4 minutes; atrazine, 10.0 minutes; azinphos methyl, 13.5 minutes.

Fenamiphos, fenamiphos sulfoxide and fenamiphos sulfone

C₁₈ column (25 cm x 4.6 mmID); isocratic elution with mobile phase 50:50 H₂O:CH₃CN; flow-rate

1 mL/min; PDA detector wavelength: fenamiphos sulfoxide and fenamiphos sulphone 224 nm and 248 nm; retention times: fenamiphos sulfoxide, 4.5 minutes; fenamiphos sulphone, 7.4 minutes; fenamiphos, 15 minutes.

Fenarimol and prometryn

C₁₈ column (25 cm x 4.6 mmID); isocratic elution with mobile phase 30:25:45 H₂O:CH₃CN:CH₃OH; flow rate 0.8 mL/min; PDA detector wavelength: fenarimol, 220 nm and prometryn 244 nm; retention times: fenarimol, 10.2 minutes; prometryn, 12.2 minutes.

Results

For the nine pesticides studied here, for any given soil, the atrazine metabolite DIA showed the lowest Kd and azinphos methyl the highest. Generally, the pesticides followed the following order of descending sorption: azinphos methyl > fenarimol > prometryn > fenamiphos > atrazine > fenamiphos sulfone > fenamiphos sulfoxide > DEA > DIA (Table 3).

The highest Kd for azinphos methyl is not consistent with the scale of hydrophobicity. In fact, among the nine compounds studied, fenarimol was the most hydrophobic and was expected to result in highest Kd values. While in several soils the Kd values of the two compounds were similar, in some other soils azinphos methyl showed a higher sorption coefficient.

Atrazine, DEA and DIA

The soils differed greatly in their sorption affinity for atrazine and its two metabolites. For example, Kd values for atrazine were 0.0–18.7 L/kg, for DEA 0.0–12.0 L/kg, and for DIA 0.0–9.8 L/kg. The highest Kd for the three compounds was found in surface soil (0–15 cm) from Profile 6 of Gavin soil under pines; by contrast, the sub-surface layers of Profile 20 of Joel soil (at 200 and 400 cm) showed no sorption. Not all sub-surface soils were low in organic matter content; indeed, the sub-surface layer of Beonaddy soil (Profile 18) had higher organic matter content than the surface layer (3.08 compared with 2.16 per cent), and Kd values were higher accordingly.

Table 3. Sorption coefficients (Kd, in L/kg) of pesticides in various soils.

Profile No.	Soil-type	Land-use	Sample Depth (cm)	OC (%)	Sorption Coefficient									
					A	DEA	DIA	F	FS	FSO	FL	AM	P	
1	J	Bb	0-15	2.90	10.64	7.52	5.85	>40	6.20	8.58	>50	>50	>70	
			40-50	0.89	4.19	2.36	2.00	28.30	2.42	2.54	49.72	>50	>70	
2	Ja	Bb	0-15	1.02	1.41	1.13	1.00	7.87	0.57	0.42	24.95	39.40	8.78	
			40-50	0.14	0.05	0.25	0.30	0.19	0.10	0.00	2.56	0.70	0.68	
3	G	Bb	0-15	2.94	5.22	2.96	2.61	28.19	3.12	3.37	49.33	>50	32.01	
			40-50	0.56	0.94	0.59	0.63	7.75	0.84	0.59	17.47	24.90	12.39	
6	G	P	0-15	4.80	18.72	11.98	9.79	>40	9.89	15.73	>50	>50	>70	
			40-50	0.66	2.56	1.16	1.18	18.45	1.66	1.13	>50	>50	29.11	
9	Sp	Bb	0-15	2.50	1.70	1.26	1.05	9.34	0.00	0.72	>50	>50	6.61	
			40-50	0.25	0.10	0.35	0.39	0.47	0.00	0.12	3.84	1.31	0.46	
13	Ky	Mg	0-15	0.82	0.55	0.79	0.64	4.81	0.18	0.67	21.57	27.91	1.54	
			40-50	0.49	8.38	0.93	0.67	3.90	0.08	0.58	20.26	41.66	1.86	
15	J	Bb	0-15	1.14	10.37	5.64	5.05	>40	5.07	7.89	>50	>50	>70	
			40-50	0.84	3.05	1.30	1.29	21.37	0.75	1.87	42.93	>50	32.99	
16	Kg	Mg	0-15	1.13	0.78	0.85	0.75	10.32	0.27	0.88	9.13	44.68	2.00	
			40-50	0.31	0.24	0.54	0.47	1.73	0.00	0.28	4.82	5.08	0.58	
18	B	Mg	0-15	2.16	1.26	1.74	1.13	16.51	0.76	1.65	27.25	>50	2.72	
			40-50	3.08	3.26	4.65	2.49	33.04	3.01	3.62	34.65	>50	5.09	
19	KLS	Mg	0-15	1.05	0.62	0.69	0.60	5.72	0.17	0.57	21.71	26.86	1.75	
			40-50	0.48	0.25	0.46	0.40	3.92	0.08	0.53	7.21	7.44	1.06	
20	J	Bb	0-10	0.86	1.73	1.62	1.19	5.45	0.42	1.14	12.32	>50	12.56	
			200	0.50	0.00	0.00	0.00	0.00	0.00	0.00	0.79	0.05	0.04	
			400	0.10	0.00	0.00	0.00	0.00	0.00	0.00	0.16	0.00	0.00	

Notes: **Soil-types**

B = Beonaddy, G = Gavin, J = Joel, Ja = Jandakot, Kg = Karrakatta Grey, KLS = Limestone, Ky = Karrakatta Yellow, Sp = Spearwood

Landuses

Mg = market gardens, P= pines, Bb = Banksia bush

Pesticides

A = atrazine, DEA= desethylatrazine, DIA= desisopropylatrazine, F = fenamiphos, FS = fenamiphos sulfoxide,

FSO = fenamiphos sulfone, FL= fenarimol, AM = azinphos methyl, P= prometryn

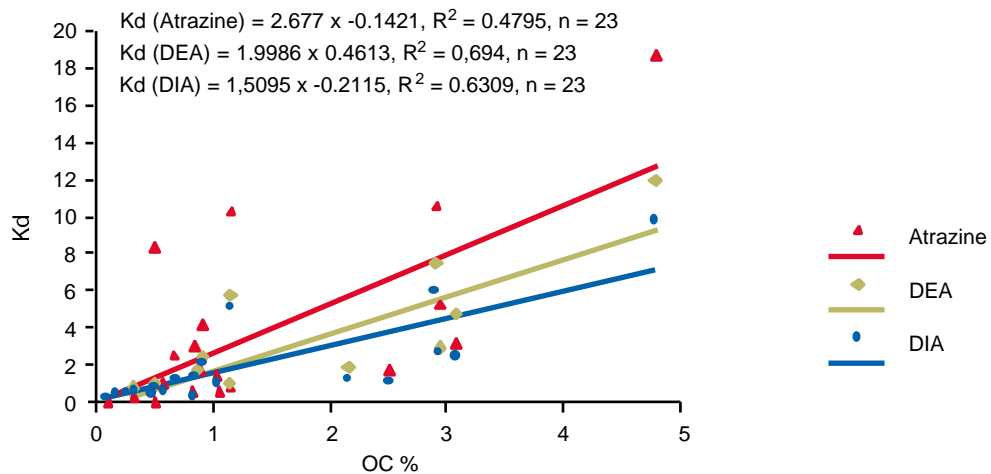

Figure 1. Relationship between sorption coefficient (Kd) of atrazine and its two metabolites (DEA and DIA) and organic carbon (OC).

Fenamiphos, fenamiphos sulfoxide and fenamiphos sulfone

Fenamiphos showed the highest sorption coefficient followed by its two metabolites FS and FSO. For example, K_d values for fenamiphos ranged from 0.0 to >40 L/kg, whereas for FS and FSO ranged from 0.0 to 15.7 L/kg. As was observed in the case of atrazine and its metabolites, the highest K_d values for the three compounds were found in the surface soil (0–15 cm) from Profile 6 of Gavin soil. The sub-surface K_d values were always lower than the corresponding values for the surface layer, due to lower organic carbon content of the sub-surface soils. However, as with the sorption of atrazine and its metabolites, the K_d values of the three compounds in the Beonaddy soil were higher in the sub-surface layer, due to a higher organic matter content. There was negligible sorption of fenamiphos and the metabolites in the Joel soil. For the two metabolites, the K_d values in several sub-surface layers were very low.

Fenarimol, azinphos methyl and prometryn

Sorption of fenarimol and azinphos methyl in most of the surface soils was very high, especially those under Banksia bush or pines. In most surface soils, sorption was so high that, after equilibration, the concentrations of the pesticides left in soil solutions were below the limits of detection. Hence the actual K_d values could not be calculated and these have been reported as greater than a certain value (for example >50 L/kg for azinphos methyl). The K_d values for fenarimol were lower and measurable in Jandakot Profile 2 and Joel Profile 20 under the same landuse, because of a lower organic carbon content of the surface soils. In Joel Profile 20, the soil samples from 200 and 400 cm showed virtually no sorption for these pesticides, despite the high inherent sorption affinity of pesticides such as azinphos methyl. In the case of prometryn, the sorption was not as high as for the other two compounds for any given soil. In terms of sorption affinity, the three pesticides followed the order: azinphos methyl > fenarimol > prometryn.

Discussion

A comparison of sorption of parent compounds and metabolites

For both atrazine and fenamiphos, the K_d values of the metabolites were much lower than those of the respective parent compounds. Sorption of both parent and metabolite decreased in the following order: atrazine > DEA DIA and fenamiphos > FSO FS. These results are consistent with the polarity of the compounds. In both cases, the metabolites are more polar than their parent compounds, making the metabolites more soluble in water and therefore

more mobile. This is consistent with other published studies on sorption of these compounds (Lee, Green and Apt 1986; Kookana, Phang and Aylmore 1997). From the point of view of environmental impact and toxicity, the metabolites assume considerable importance, especially in the case of fenamiphos, where the metabolites FS and FSO are as equally toxic and active against the pests as the parent compound. Given that, due to lower sorption than their parents, the metabolites are much more mobile, they deserve to be taken into account in any assessment of groundwater pollution potential of these pesticides.

Effect of landuse on sorption of pesticides

The soils under intensive cultivation (market gardens) had lower K_d for the pesticides than those under Banksia bush or pines. This is generally reflected in the organic carbon contents of the soils, which tended to be lower in the market garden soils. A comparison of soils with similar organic carbon under natural vegetation (Banksia bush) and intensive cultivation (market gardens) showed that the sorption was comparable for some pesticides and not for others. For example, surface soils of Profile 2 (Jandakot) under Banksia bush and Profile 16 (Karrakatta Grey) under market gardens both had about one per cent OC, and therefore K_d s for several pesticides were comparable. However, in the case of fenarimol and prometryn, the Jandakot soil under Banksia bush showed substantially higher K_d values than the Karrakatta Grey soil. A similar pattern is observed when the surface soils from Profile 9 of Spearwood (under Banksia bush) and Profile 18 of Beonaddy (under market gardens) are compared.

The reasons for the difference in sorption of fenarimol and prometryn for these soils may be linked to the differences in other soil properties such as pH. Indeed the pH of soils under market gardens were near neutral, whereas all other soils were acidic. Soil pH can influence the sorption of ionizable pesticides such as prometryn and atrazine, both of which are weakly basic in nature.

Relationship between K_d and organic carbon

Despite similar solubilities of prometryn and atrazine, the K_d values for prometryn were generally higher. This is likely to be due to greater sensitivity of prometryn to pH differences, resulting from its higher pK_a , as shown in Table 2.

The relationship between sorption and organic carbon was explored further by plotting the K_d of atrazine and fenamiphos (and their respective metabolites) against organic carbon (Figures 1 and 2).

The data in the two figures show a trend of increasing sorption with increasing organic carbon content, but a considerable scatter is evident for all

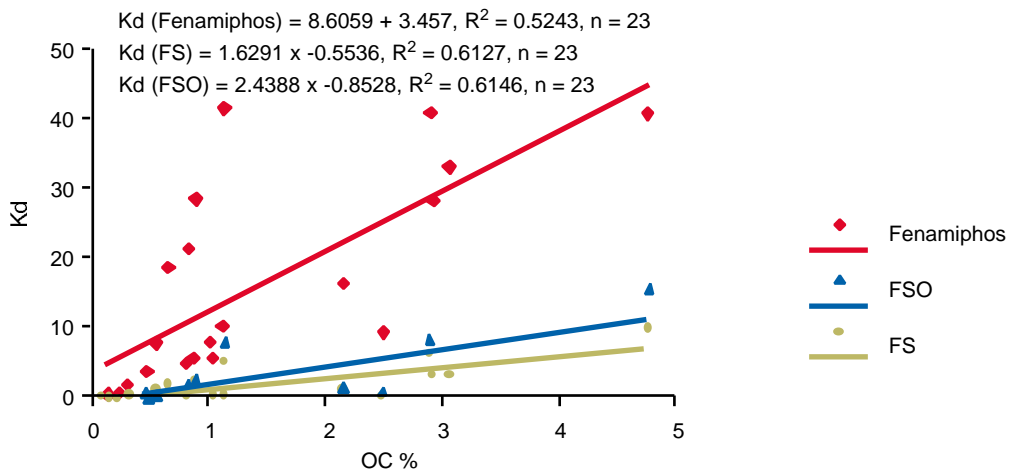

Figure 2. Relationship between sorption coefficient (K_d) of fenamiphos and its two metabolites (FSO and FS) and organic carbon (OC).

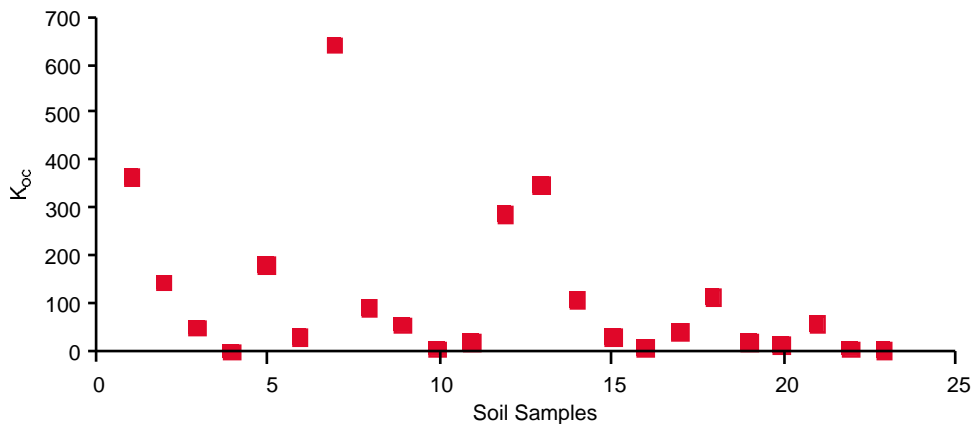

Figure 3. Variations in K_{oc} for atrazine in various soils (soil sample numbers correspond to those in Table 1).

Table 4. Sorption for various pesticides.

Pesticide	Sorption (K_{oc})			
	Mean \pm SD	Median	Range	Overseas Mean
atrazine	114 \pm 160	49	0–645	100
DEA	73 \pm 98	39	3–415	–
DIA	60 \pm 79	35	5–338	–
fenamiphos	495 \pm 492	271	0–1403	100
FS	53 \pm 86	14	0–341	–
FSO	79 \pm 129	25	0–542	–
fenarimol	905 \pm 669	749	6–1744	600
azinphos methyl	655 \pm 912	175	0–2463	1000
prometryn	1154 \pm 706	1541	0–1724	400

Notes: $K_{oc} = 100 \times K_d / \text{OC}\%$; SD = standard deviation

Overseas data are from Wauchope et al. 1992

'Overseas mean' K_{oc} for fenamiphos is weighted for sulfoxide as major residue.

pesticides. For example, the soils with OC of 2.5–3 per cent showed a K_d for fenamiphos of 10–40 L/kg. The correlation coefficient did not improve when the data from the surface soil only were plotted (results not shown). The relationship was, however, better for the metabolites than the parent compounds for both atrazine and fenamiphos. For example, while only 48 per cent of variation in the K_d for atrazine was explainable on the basis of organic carbon content of the soil, for DEA it was 69 per cent. The reason for a better correlation for the metabolites is likely to be due to the smaller magnitude of sorption of the metabolites resulting in a smaller scatter.

The poor correlation between K_d and OC is not surprising because not only can other factors, such as pH and clay content, affect the K_d , but also the type of organic matter (in terms of its aromaticity and stage of decomposition) is an important determinant of pesticide sorption (Ahmad et al. 2001). The nature of organic matter in surface soils and subsoils, as well as in soils under different landuses, is likely to be quite different.

A comparison of sorption data with that reported from overseas

The K_d and organic carbon values from Table 3 were used to derive sorption (K_{oc}) for each pesticide in each soil. K_{oc} values for each pesticide are compared with overseas data in Table 4.

If organic matter was the sole sorbent and the OC in all soils had the same sorption capacity per unit mass for each pesticide, then a narrow range of K_{oc} would be expected. However, it is clear from the table that K_{oc} ranged widely between soils, as is evident from the high standard deviations. For example while K_{oc} values for atrazine varied between soils by nearly three orders of magnitude, most of the K_{oc} data fell between 10–100. This pattern is shown in Figure 3. The pattern for other pesticides was similar.

Prometryn stood out as the pesticide with a much higher mean and median K_{oc} value than those reported in the overseas database (Table 4). This may have been caused by the acidic nature of several soils used in the study. Prometryn, being a weak base with a pKa of 4.05 (see Table 2), would be affected substantially by pH in these soils. The huge variation in K_{oc} values for various pesticides suggests that average K_{oc} values available in overseas databases for site-specific assessments of pesticide sorption are inadequate, especially for subsurface soils.

Conclusions

A study was conducted to estimate the sorption of nine different pesticides in 23 soils of the Swan Coastal Plain surface (0–15 cm) and subsurface

(40–50 cm) soils were collected from several sites under native vegetation (Banksia woodland) and market gardens. Sorption was measured by a batch equilibration method for several pesticides, namely atrazine and its two metabolites (desethylatrazine and desisopropylatrazine), fenamiphos and its two oxidation analogues (sulfoxide and sulfone), prometryn, azinphos methyl and fenarimol.

Sorption per unit mass of organic carbon in soils (K_{oc}) showed a wide variation among the soils studied, possibly reflecting the varying nature of organic materials present in the soils. Organic carbon content alone could not explain the differences in pesticide sorption among soils. The sorption figures were much lower in the subsoils, which suggests that in such soils, once the pesticide leaches beyond 50 cm depth, it can essentially move with the water-front with little retardation due to sorption. The metabolites of atrazine and fenamiphos had much lower sorption affinities for soils than their respective parent compounds. The metabolites of fenamiphos had up to an order-of-magnitude lower sorption than the parent compound in some soils. Given that these metabolites are equally toxic in nature and more persistent than the parent compound, the groundwater pollution potential of these metabolites needs adequate consideration.

References

- Ahmad, R., Kookana R.S., Alston, A.M. and Skjemstad, J.O. 2001. The nature of soil organic matter affects sorption of pesticides. I. Relationship with carbon chemistry as determined by ¹³C NMR spectroscopy. *Environmental Science and Technology* 35: 878–884.
- Bauld, J. 1996. Groundwater quality: human impact on a hidden resource. *Proceedings of 23rd Hydrology and Water Resources Symposium, Hobart, 21–24 May: 143–147.*
- Kookana, R.S., Baskaran, S. and Naidu, R. 1998. Pesticide fate and behaviour in Australian soils in relation to contamination and management of soil and water — a review. *Australian Journal of Soil Research* 36: 715–764.
- Kookana, R.S., Phang, C. and Aylmore, L.A.G. 1997. Transformation and degradation of fenamiphos nematocide and its metabolites in soils. *Australian Journal of Soil Research* 35: 753–761.
- Lee, C. C., Green, R. and Apt, W. J. 1986. Transformation and adsorption of Fenamiphos, F. sulfoxide and F. sulfone in Molokai soil and simulated movement with irrigation. *Journal of Contaminant Hydrology* 1: 211–225.
- Vighi, M. and Funari, E., eds., 1995. *Pesticide risk in groundwater*. CRC Lewis Publishers, London.
- Wauchope, R. D., Buttler, T. M., Hornsby, A. G., Augustijn-Beckers, P. M. W. and Burt, J. P. 1992. The SCS/ARS/CES pesticide properties database for environmental decision-making. *Reviews of Environmental Contamination and Toxicology* 123: 1–164.

Nutrient and Pesticide Leaching in Experimental Sites in the Swan Coastal Plain

R.B. Salama, J.D. Byrne and D.W. Pollock¹

Abstract

Different methods were used to sample soil water and groundwater from the unsaturated and saturated zones of two experimental sites in the Gnangara Mound. The results show that suction cups give more representative samples at the selected depth and time, while lysimeters give an integrated sample over a longer period. The results from the suction cups at various depths were in accordance with anticipated natural attenuation, and with the concentrations in groundwater. On the other hand, the results from the lysimeters were lower and did not reflect the higher fluxes encountered in the groundwater samples. Traces of the tested pesticides (atrazine, diazinon, dimethoate, endosulfan, fenamiphos, iprodione, malathion and chlorpyrifos) were detected in soil samples in two experimental farms in the Gnangara Mound. However none of the pesticides was detected in the groundwater samples collected by the different techniques from depths ranging from 30 cm to 2.0m. Due to excessive application of nutrients and the shallow groundwater depth, NH_4 and NO_3 were leaching to the groundwater at high rates. Initial N levels were high and rapidly decreased by depth and by distance away from the agricultural areas. The results also show that the leaching process can be greatly reduced by reducing irrigation and applying the recommended fertiliser rates.

SEVERAL METHODS for assessment of soil-water quality were experimented with in two sites in the Gnangara Mound to monitor the movement of nutrients and pesticides through soils to the unconfined aquifers. The porous ceramic suction cup and the free-draining lysimeter, as well as gravimetric soil sampling, were used in the unsaturated zone. Multi-level samplers and piezometers were used in the saturated zone. The main objectives of this study were to:

- compare the different sampling methods and assess their suitability by comparing the results of pesticides and inorganic pollutants such as $\text{NO}_3\text{-N}$, $\text{PO}_4\text{-P}$, $\text{NH}_4\text{-N}$, and pH
- monitor nutrient and pesticide leaching using different sampling techniques
- utilise the data to calibrate and validate applied models (Salama, Pollock and Byrne 2001).

Location and Methods

Two experimental sites were chosen, a strawberry farm and a turf farm. The sites were located on the Swan Coastal Plain on Bassendean Dune System

sands series (Figure 1). The Bassendean Dune System sands were formed of aeolian and fluvial depositional material with the sand grains being well sorted and rounded. The two sites are located on the Gavin and Joel sands where groundwater is within two metres of the soil surface, and the subsoil has a cemented iron-humus podsol associated with the watertable. The average bulk density of these sands is 1.5 gm/cm^3 with a greater than 98 per cent sand fraction within virgin soil.

Lysimeters, ceramic suction cups, multi-level soil-water sampling piezometers, and groundwater-sampling tubes were installed. They were sampled seven times between 19 September and 17 November 1997.

A water meter, similar to Water Corporation meters used for domestic homes, was installed in irrigation lines before the sprinklers and used to record water applied to the area surrounding the lysimeters. The irrigation sprinkler was either a *Rainbird* or a *Hunter* irrigation sprinkler with a throw

¹ CSIRO Land and Water, Private Bag No 5, PO Wembley, Western Australia 6913

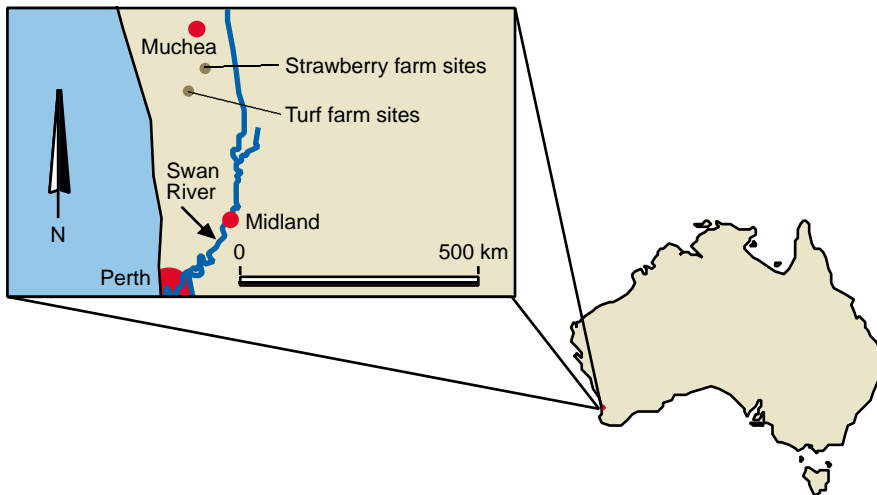

Figure 1. Location of experimental sites.

of 18 m. Rain events and amounts were recorded by a 0.2 mm tipping-bucket rain gauge which was installed approximately 100 m south-west of the lysimeters in an open area out of the influence of irrigation sprinklers.

Soil was sampled with an alloy tube, 47 mm ID x 50 mm OD x 300 mm, using a piece of wood and a hammer to gently tap the alloy tube with the sharpened end down into the soil to its full length. The sample tube was sealed at both ends with aluminum foil and the ends were taped airtight. The sample was placed into a car freezer and transported to the laboratory. At the strawberry farm the soil was sampled from the immediate surface. No soil was removed prior to sampling. At the turf farm, turf was removed to a depth of 30 mm removing both the turf itself and immediate dense root material associated with this level. The soil was sampled from this level down to 300 mm using a single-length alloy tube.

Strawberry farm

During the experiment, the Chandler variety of strawberries was planted in the farm. It is a short-day variety planted in winter. The crop was planted in the first week of June 1997. The seedlings were planted on metre-wide mounded soil beds in two rows 30–50 cm apart with plants staggered 30–40 cm apart. The average plant produces 0.75–1.0 kg per season. The picking season starts at the end of August or beginning of September. Picking takes place every second day and continues to the end of November when the crop is abandoned and spray-killed to avoid spread of fungal diseases.

The site of the experiment had been fallow for 18 months. The farmer had pre-treated the soil with raw chicken manure and mounded the bed area ready for

installation of plastic sheeting and crop planting. The crop was planted under plastic sheeting covering the metre-wide strawberry beds. This technique made it possible to measure soil water concentrations of applied chemicals from fertigation lines and pesticides applied by overhead spray from a tractor under two different conditions: under plastic; and uncovered areas.

Six small surface-area free-drainage lysimeters were installed in positions that ensured that both plants and water fertigation lines were directly above the instruments. Lysimeters and ceramic suction cups (Figure 2) were also installed under the interbed area between the strawberry beds (Figures 3–4). The interbeds are 40 cm wide and subject to overhead sprinkler, precipitation plus spray applications. This enabled sampling of soil chemicals and pesticides without the effect of plants.

Each lysimeter was installed in a 70 cm square hole. The top 30 cm of organic topsoil was set aside and placed back into position after lysimeter installation. All soil was removed to a depth of 1.2 m and stockpiled on plastic sheeting. Once the lysimeters were installed, the soil was replaced and compacted to near field density. Of the six lysimeters, five were of the same design (Figure 5): 70 cm tall x 40 cm square with a leachate collection chamber. They also had a floor sloping towards the extraction outlet of the lysimeter. This allowed the extraction of all the leachate within the chamber. The sixth lysimeter was 30 cm shorter and had no sloping floor. The leachate was extracted via individual semi-rigid nylon tubes inserted into the lysimeters' collection chambers. Inside the lysimeters, soil leachate was filtered

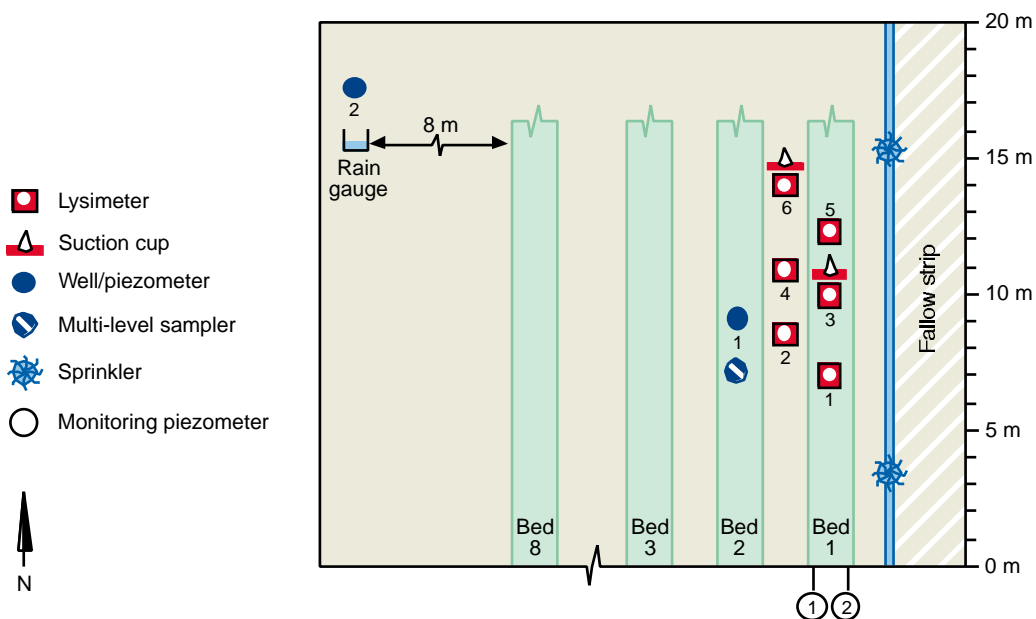

Figure 2. Instrumentation setup at the strawberry farm.

through a 45–90 μm nylon felt fabric material. The material was supported on a galvanised iron grid-mesh floor. Sampling of soil leachate from the lysimeter was achieved by a vacuum pump attached to a pyrex glass vacuum flask connected via a semi-rigid nylon tube from the lysimeter and teflon and stainless steel tubing to minimise contamination and loss of any chemicals or sorption of pesticides.

Two sets of three ceramic suction cups were installed at two locations, one set under each strawberry bed and interbed. The first suction cup was installed at 30 cm depth between the topsoil and subsoil (Figure 4). The second and third cups were placed at depths of 50 cm and 70 cm. The difference in levels between the interbeds and beds resulted in the first suction cup (30 cm) in the interbed being only 15 cm below the ground surface. The travel time for nutrients to this set of suction cups could be shorter, depending on difference in water application rates. The suction cups were evacuated and sampled via 60 ml syringes attached to each individual suction cup. The tubing on each suction cup was a hard nylon tube which did not sorb pesticides.

A set of multi-level groundwater sampling tubes ('sippers') was installed in the middle of the bed next to the lysimeters. The depths of installation were 0.6, 0.8, 1.0, 1.2, 1.4, 1.6, 1.8 and 2.0 m from ground-level. The samples were obtained by suction using individual syringes for each sampling depth.

Two piezometers were installed in the site, one in the crop area and the other west of the strawberry crop bed. They were installed to a depth of 2.5 and 3 m respectively using 50 mm diameter slotted aluminium pipe. Data loggers and water-level probes were installed in the piezometers to monitor water-level changes.

Water application was by 2 m overhead sprinklers, 15 mm slotted irrigation lines and by rainfall. The slotted irrigation lines were installed on each side of the crop bed on each side of the strawberry plants under black plastic sheeting. The plastic covered the whole width and length of the crop bed. The plastic was used to reduce soil moisture evaporation and to maintain an even soil moisture content and soil temperature.

Rain events were recorded by a 0.2 mm tipping bucket rain gauge installed west of the strawberry beds in an open area out of the influence of irrigation sprinklers (Figure 2). The rainfall pattern is shown in Figure 6.

Turf farm

Three lysimeters were placed under Wintergreen Turf (Figure 7). The lysimeters were 60 cm tall and 40 cm square with a 15 cm deep collection chamber in the base including a sloped floor for better drainage. Three were installed in a line starting two metres in from a limestone road; the other two were equally spaced with two metres centre-to-centre between all

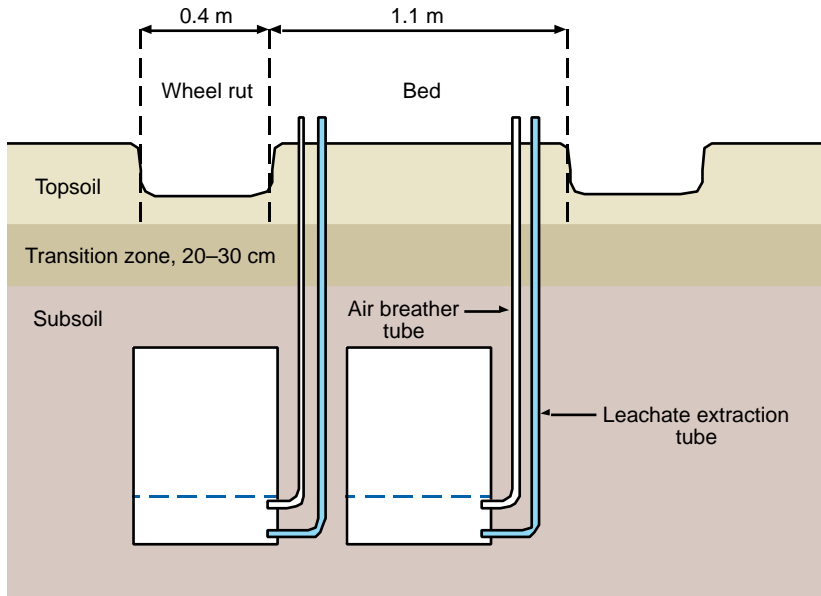

Figure 3. Lysimeter installation (strawberry farm).

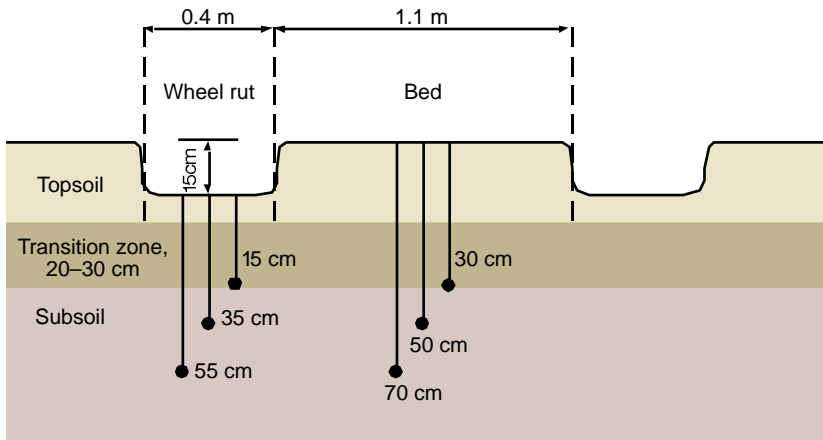

Figure 4. Suction cup installation (strawberry farm).

lysimeters (Figure 8). The turf was removed and placed to one side and then the soil from each hole removed in 20 cm intervals and piled on plastic sheeting nearby. The lysimeters were then installed and the soil layers returned in sequence. The soil was compacted back at each level to as close as to field bulk density as could be achieved. The turf was then placed back and hand compacted back to the sur-

rounding surface level. The leachate dripped into the collection chamber and samples were taken via a vacuum pump connected to a glass volumetric flask. Each lysimeter had a separate glass flask to prevent contamination.

Suction cups were installed in the lysimeter holes before the installation of the lysimeters. Each of the three holes had a set of three suction cups installed in

Results and Discussion

Infiltration and water balance

The results of a long-term study in 1998 in the strawberry farm showed that infiltration in winter and summer were 421 and 189 mm respectively. The total recharge was 44 per cent of the total water input during this period, which included 558 mm of rain. Due to the shallow depth to groundwater, it was assumed that all the water infiltrating past the lysimeter would reach the groundwater as recharge.

In short-term studies infiltration was measured for selected periods in late 1997 (Table 1). In the turf farm (between August and November) that infiltration was about 62 per cent of total water input. By contrast, in the strawberry farm (between July and November) infiltration was only 26 per cent.

Water-level fluctuations in the strawberry farm piezometer showed two distinct patterns during the recession period from September to November (Figure 9). The first pattern occurred when no irrigation was applied; the recession fell smoothly without daily fluctuations. The second pattern was noticed when irrigation started, with the water-level showing rises of 2–5 cm whenever irrigation was applied. This was clear evidence that most of the irrigation water reaches the watertable at the rate of 6–15 mm per irrigation; Specific Yield (S_y) = 0.3.

Pesticides

Although some traces of the tested pesticides (atrazine, diazinon, dimethoate, endosulfan, fenamaphos, iprodione, malathion and chlorpyrifos) were detected in soil samples in two experimental farms in the Gngangara Mound, none of the pesticides was detected in the groundwater samples collected by the different techniques from depths ranging from 30 cm to 2.0 m (Table 2).

Nutrients

In the turf farm (Figure 10), nitrate-N concentrations in leachate increased with time and depth in the suction cups (10–350 mg/L). In the groundwater samplers the concentrations increased with time and (slightly) with depth (2–60 mg/L). In the lysimeters, concentrations increased with time (10–100 mg/L). Ammonium concentrations decreased with depth and increased with time in all sampling points. The level of phosphate was high near the surface sampling points (10–95 mg/L), but decreased with depth below 0.75 m and remained constant at 2.0 m.

In the strawberry farm, the results from the suction cups below the beds (Figure 11) showed that the concentrations of nitrate decreased with depth but

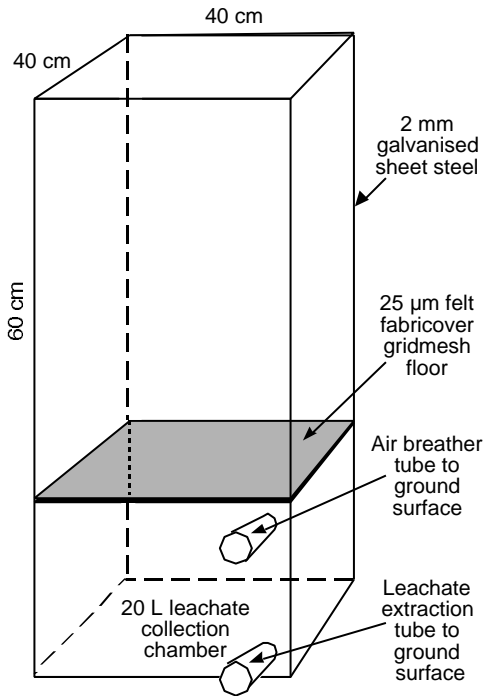

Figure 5. Typical lysimeter design used at both farms.

holes bored 40 cm horizontally into the soil. Each suction cup was installed into the hole using a fine grade silicon slurry to ensure contact with the surrounding soil. Depths of each set of suction cup were 30 cm, 60 cm and 90 cm respectively. The suction cups were 60 mm in length and 48 mm in diameter, being slightly larger in surface area than those used at the strawberry farm. The suction cups were evacuated and sampled via 60 ml syringes attached to each individual suction cup. The tubing on each suction cup was a semi rigid hard nylon tube, which did not sorb pesticides.

Multi-level groundwater sampling points were installed 4 m north of the middle lysimeter. The depths of installation were 1.4, 1.6, 1.8, 2.0 and 2.2 m from ground-level.

Two piezometers were installed (Figure 8), the first one near the limestone road in the 40 cm verge of the turf grass area; the other was installed 12 m east of the boundary of the turf farm in the banksia bushland and east of the lysimeters. They were installed at a depth of 3 m using 50 mm diameter slotted aluminium pipe. A third piezometer installed by Agriculture Western Australia was used for the recording of groundwater level fluctuations using a data logger and water-level probe.

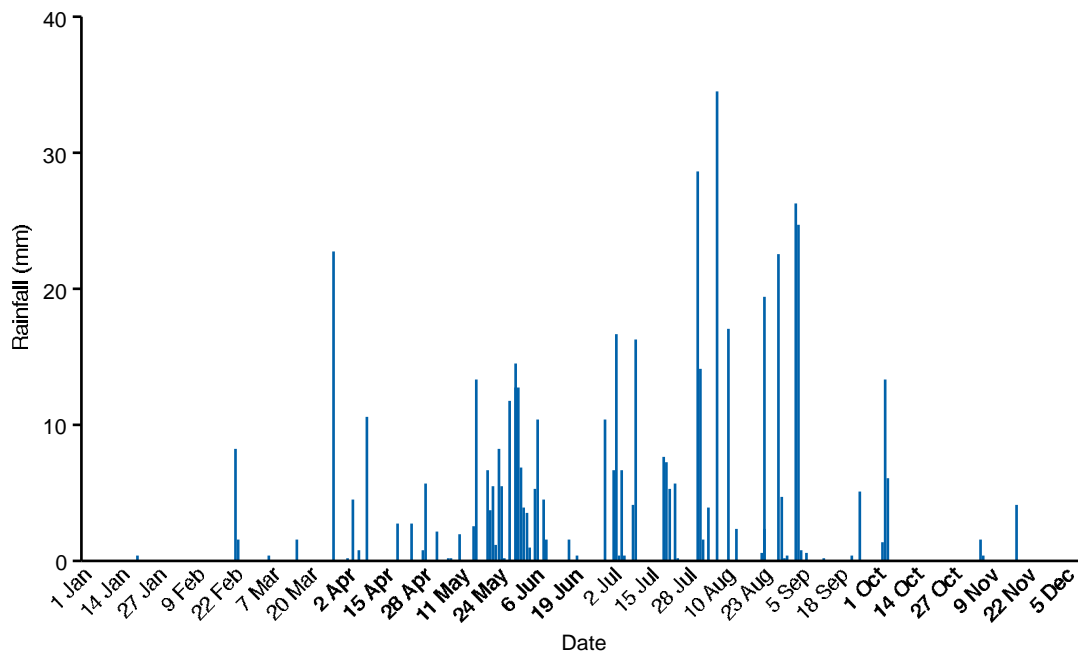

Figure 6. Daily rainfall from Pearce Weather Station, Bulls Brook, near both farms (1997).

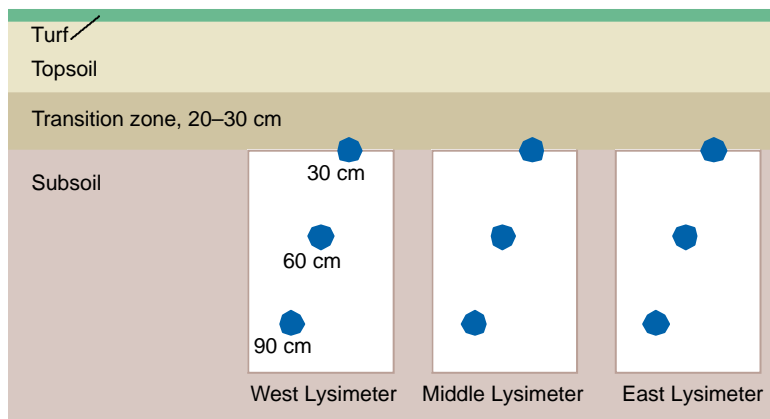

Figure 7. Location of lysimeters and suction cups (turf farm).

Table 1. Water balance of strawberry and turf farms.

Inputs (mm)			Outputs (mm)			Ratios			
R	P	I	IT	Et	Ep	R/IT	I/IT	IT/Ep	Et/Ep
<i>Strawberry farm</i> (18/08/97–17/11/97)									
226.00	430.60	426.00	856.60	630.60	423.20	0.26	0.50	2.02	1.49
<i>Turf farm</i> (23/07/97–25/11/97)									
153.60	134.00	115.58	249.58	95.98	324.50	0.62	0.46	0.77	0.30

Notes: R = Recharge, P= Precipitation, I = Irrigation, IT = Total water input (including recharge), Et = Estimated evapotranspiration, Ep = 'Class A' pan evaporation.

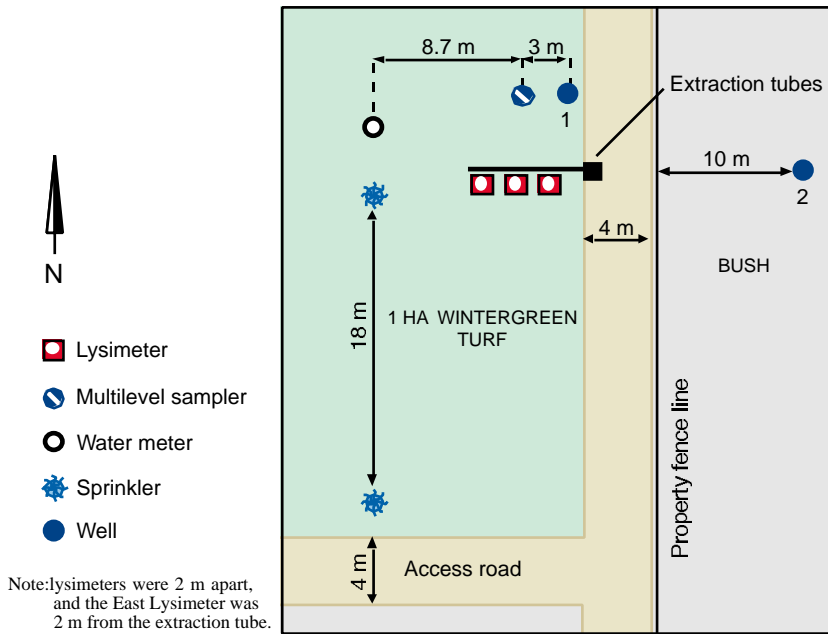

Figure 8. Location of lysimeters and other instrumentation (turf farm).

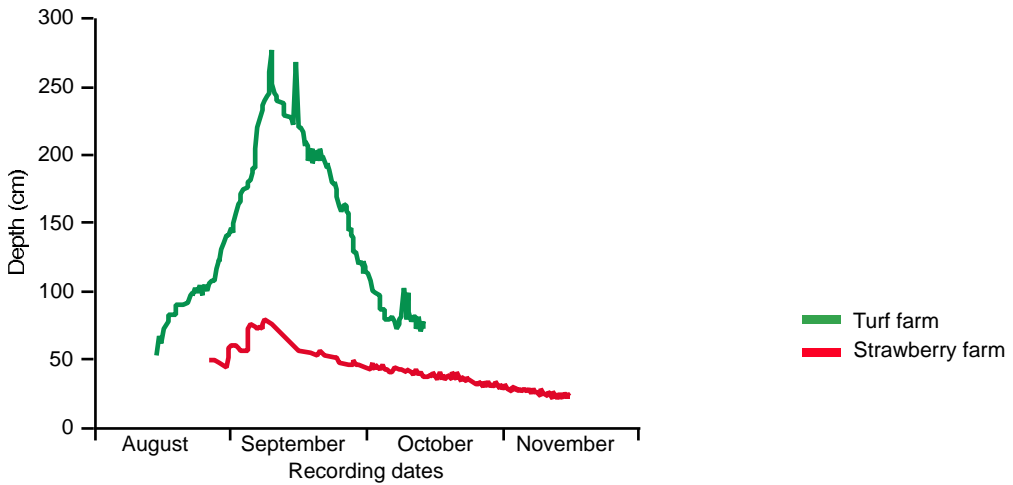

Figure 9. Water-level fluctuations.

Table 2. Pesticide analysis.

Depth of Sample (cm)	Pesticide ($\mu\text{g}/\text{kg}$)						
	Atrazine	Diazinon	Dimethoate	Endosulfan	Chlorpyrifos	Fenamiphos	Malathion
<i>Strawberry farm (18/09/97)</i>							
0–10	<1	<5	<10	<10	<5	<5	<5
10–20	<1	<5	<10	<10	<5	<5	<5
20–30	<1	<5	<10	<10	<5	<5	<5
<i>Turf farm (14/10/97)</i>							
0–10	<1	<5	<10	<10	<5	<5	<5
10–20	<1	<5	<10	<10	<5	<5	<5
20–30	<1	<5	<10	<10	<5	<5	<5

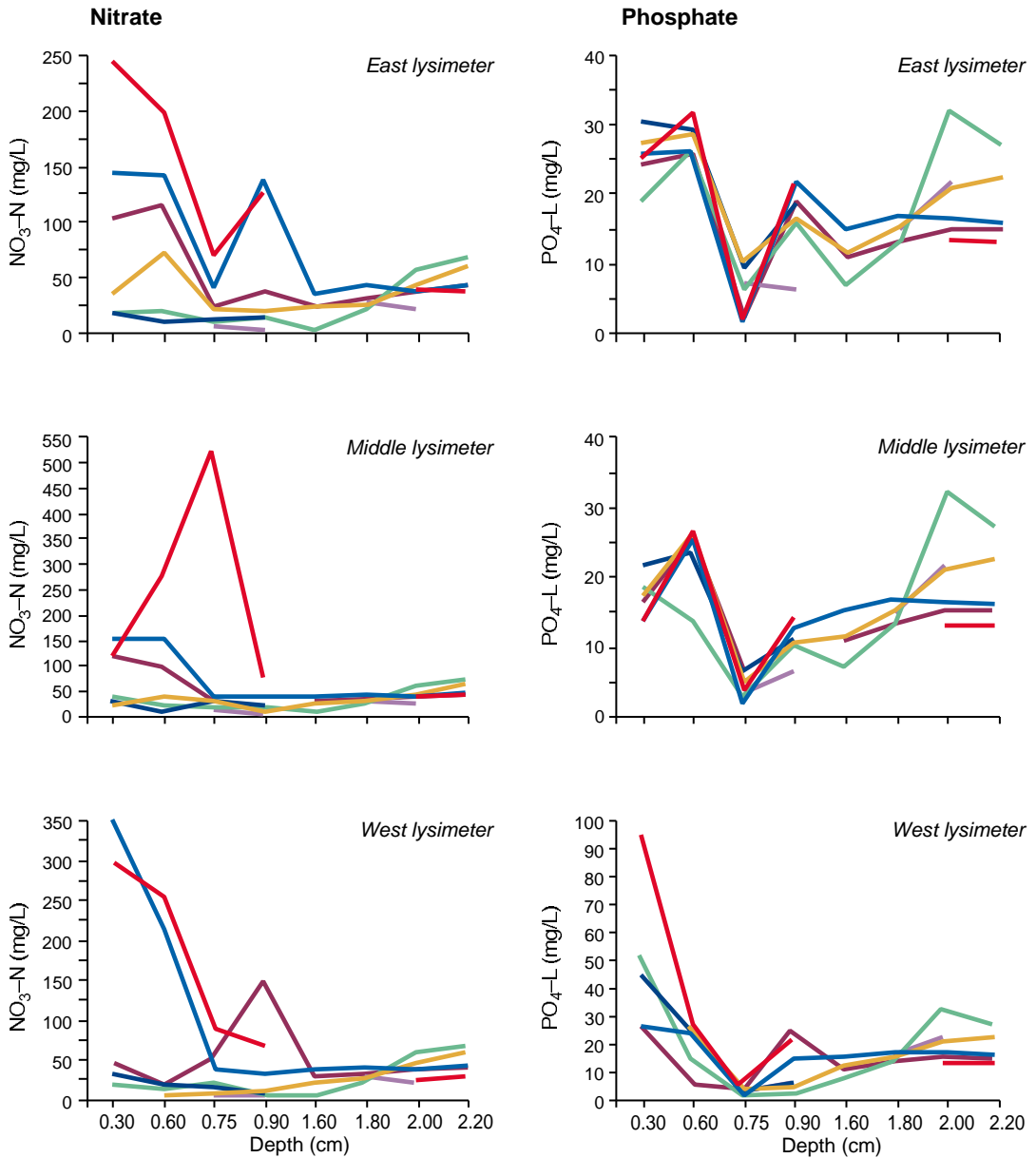
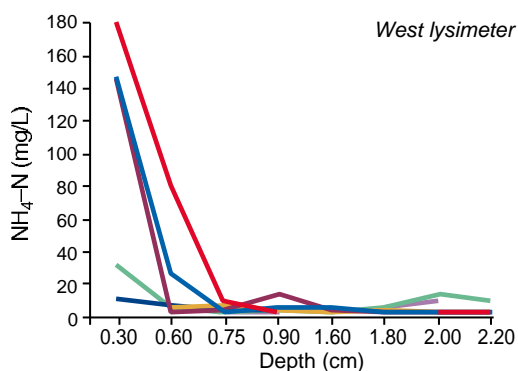
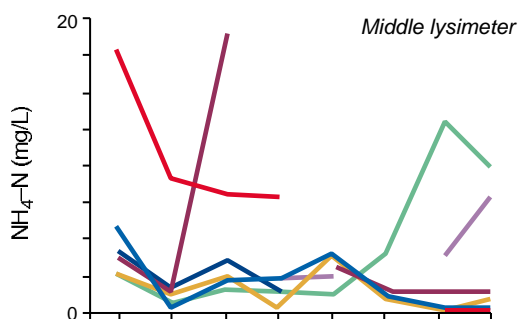
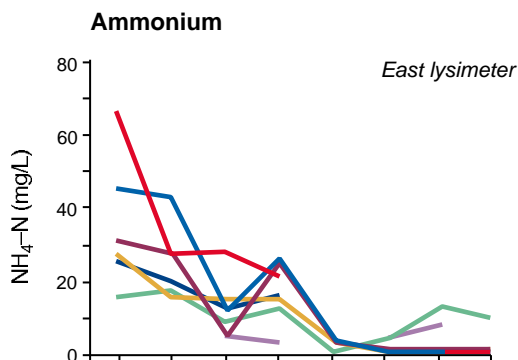

Figure 10. Distribution of NO_3 , PO_4 and NH_4 in the beds at the turf farm.

Table 3. Nutrient balances for strawberry and turf farms (lysimeter data).

Inputs			Flow-weighted Concentration (mg/L)						Outputs					
Fertiliser (kg/ha)			$\text{NO}_3\text{-N}$			$\text{NH}_4\text{-N}$			Yield (kg/ha)			$\text{PO}_4\text{-P}$		Cl
Total N	$\text{PO}_4\text{-P}$	Cl	$\text{NO}_3\text{-N}$	$\text{NH}_4\text{-N}$	Total N	$\text{PO}_4\text{-P}$	Cl	$\text{NO}_3\text{-N}$	$\text{NH}_4\text{-N}$	Total N	$\text{PO}_4\text{-P}$	Cl		
<i>Strawberry farm (28/05/97-25/11/97)</i>														
384.80	46.80	0.00	34.62	3.22	37.84	6.74	29.73	61.02	5.67	66.69	11.88	52.41		
<i>Turf farm (18/08/97-17/11/97)</i>														
282.30	85.20	0.00	49.56	5.39	54.95	4.32	119.07	84.44	9.19	93.64	7.37	202.88		



Legend for Figures 10–12.

- 12/9/97
- 19/9/97
- 25/9/97
- 13/10/97
- 21/10/97
- 3/11/97
- 17/11/97

increased with time. In the groundwater samplers, nitrate decreased with depth and increased with time; in the lysimeters, concentrations slightly increased with time.

In the interbeds (Figure 12), nitrate systematically increased with both depth and time in the suction cups; in the groundwater samplers, concentration decreased with depth and slightly increased with time. There was no change in the lysimeter readings.

In both the beds and the interbeds, phosphate decreased with depth and slightly increased with time in the suction cups, decreased with depth and slightly decreased with time in the groundwater samplers, and did not change in the lysimeters. Ammonium concentrations decreased with depth and increased with time at all sampling points.

The overall results showed that due to the excessive application of nutrients, NH_4 and NO_3 leached to the groundwater at high rates. Nitrogen levels (15–54 mg/L) were above the acceptable limits in the top 1.6 m of the shallow aquifer system; this trend decreased abruptly below 2.0 m where the concentrations were 1.0 mg/L or less. Phosphorus increased with time, and decreased with depth; concentrations were 4–10 mg/L above 1.6 m and decreased to 2–4 mg/L below that depth. Ammonium concentrations ranged from <1.0 to 4 mg/L in the top 60 cm.

Leachate concentration

In the turf farm the nitrate increased with time and increased substantially when more fertiliser was applied. The concentration in the suction cups decreased regularly with depth, but the results from the lysimeters that were installed at 0.75 m were always lower than the results from the suction cup which was installed at 0.9 m. This was mainly due to variations in the disturbance caused by the installation techniques, sample size, extent of temporal integration, and to a minor degree the spatial variability (Ahmed, Sharma and Richards 1996). Concentrations continued to decrease with depth to the surface of the groundwater, and thereafter it began to increase slightly in the groundwater below 2.0 m.

Although Ahmed et al. concluded that lysimeters gave more reliable results than suction cups, results from this experiment showed that for detailed studies of water and solute movement in the unsaturated zone, the suction cups gave more reliable results than the modelling results (Salama, Pollock and Byrne 1999). However, a comparison of results among suction cups, groundwater samplers and lysimeters shows that the nitrate concentrations in samples from

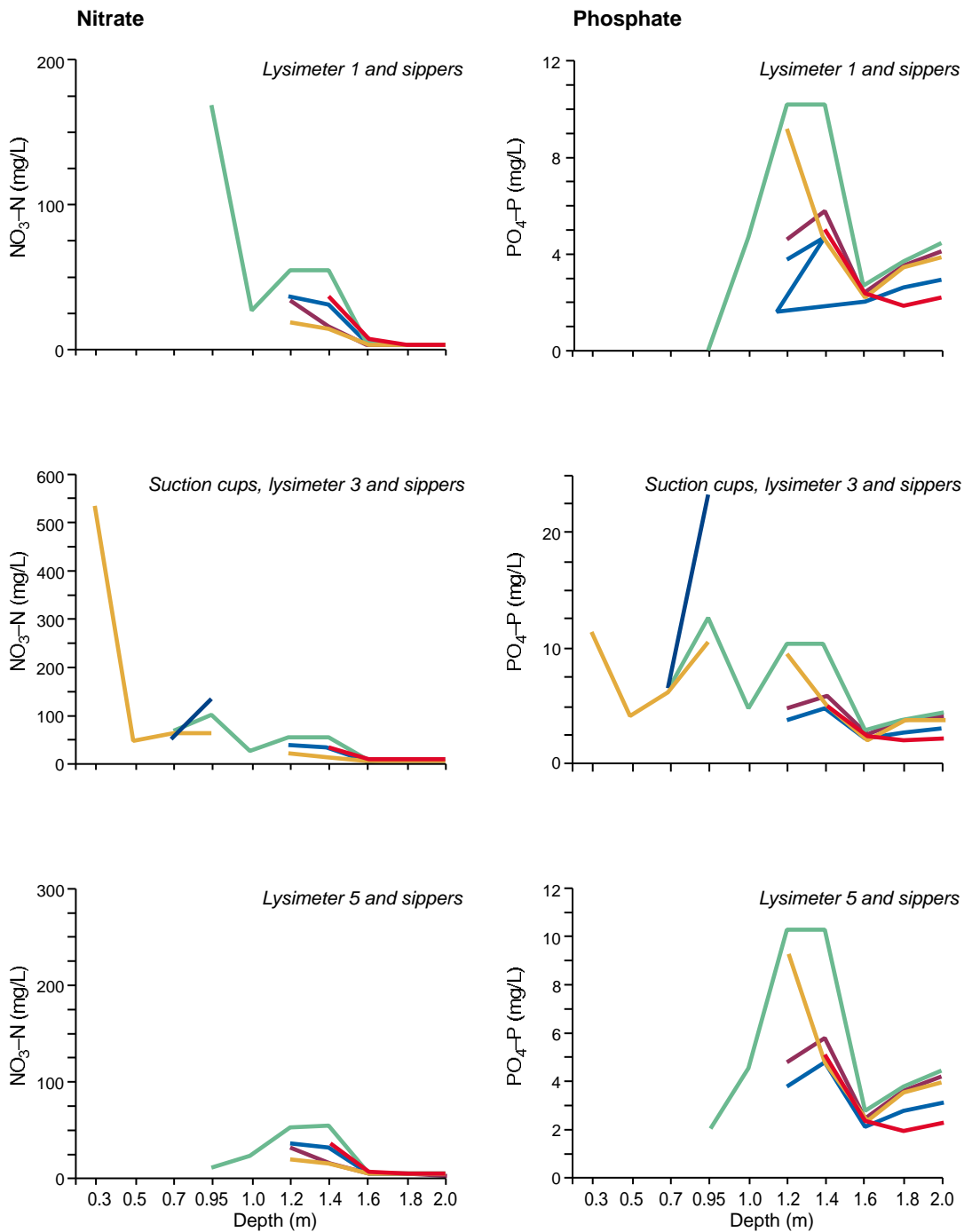
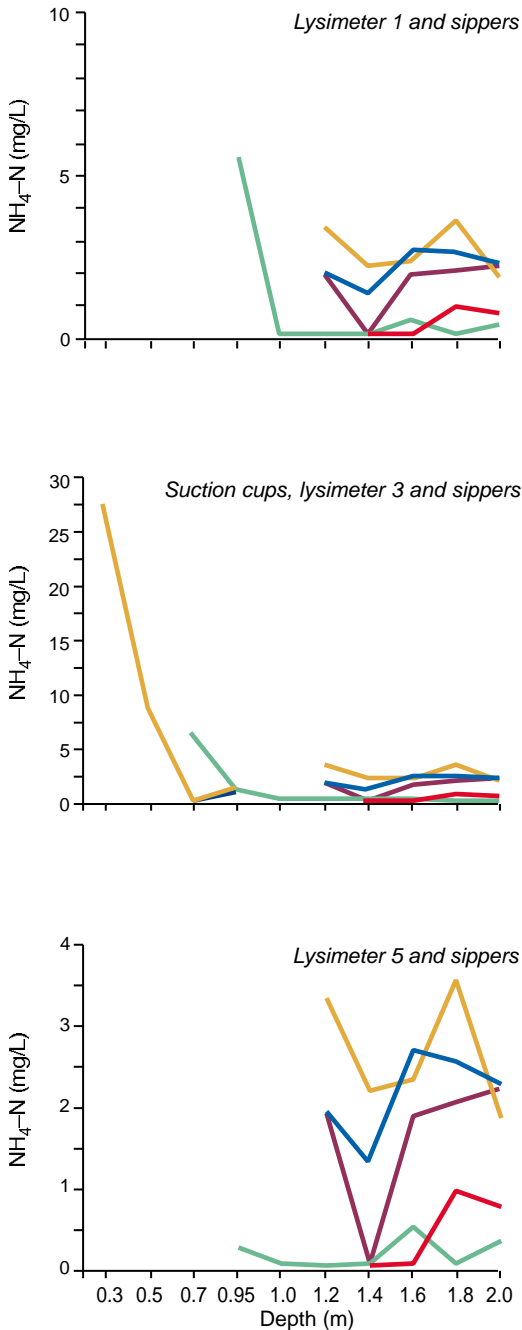

Figure 11. Distribution of NO_3 , PO_4 and NH_4 in the beds at the strawberry farm.

Ammonium



the lysimeter were in most cases lower than those in the groundwater, and did not match the gradual decrease in concentration with depth from surface to groundwater.

The phosphate results were in general similar to those of the nitrate, although much lower in concentration. The concentrations in the lysimeter were very low compared with the other results from the suction cups and groundwater. It is possible that the higher degree of disturbance in the construction of the lysimeters and the compaction applied to the top organic layer may have caused more fixation of the P than the other methods. The P also increased slightly in groundwater by depth. Ammonium on the other hand decreased regularly with depth including the lysimeter. The results from the three different sets of samplers showed the variation in application rates of fertilisers, irrigation water, plant uptake and spatial variability in soil hydraulic properties.

Although the results from the strawberry farm followed the same trend as those of the turf farm, the results for nitrate from the samples under the strawberry beds are higher than the interbeds as most of the nutrients were supplied through the fertigation lines. There were no discernible patterns for NH_4 and P.

Nutrient leaching and balances

Fertiliser application rates are shown in Table 3. During the short-term monitoring in the strawberry farm, 384 kg/ha of N and 47 kg/ha of P were applied, the lysimeter outputs were 67 kg/ha of N and 12 kg/ha of P. This indicated that 82 per cent of the N and 25 per cent of the P were either used by the plants, volatilised or retained in the topsoil. It also indicated that the remaining portion of the nutrients would reach the groundwater.

During the long-term monitoring in the strawberry farm smaller amounts of nutrients were applied and the results showed that 36 per cent of the N and 26 per cent of the P passed the root zone. In the turf farm, the results showed that 33 per cent of N and 8 per cent of P passed through the root zone.

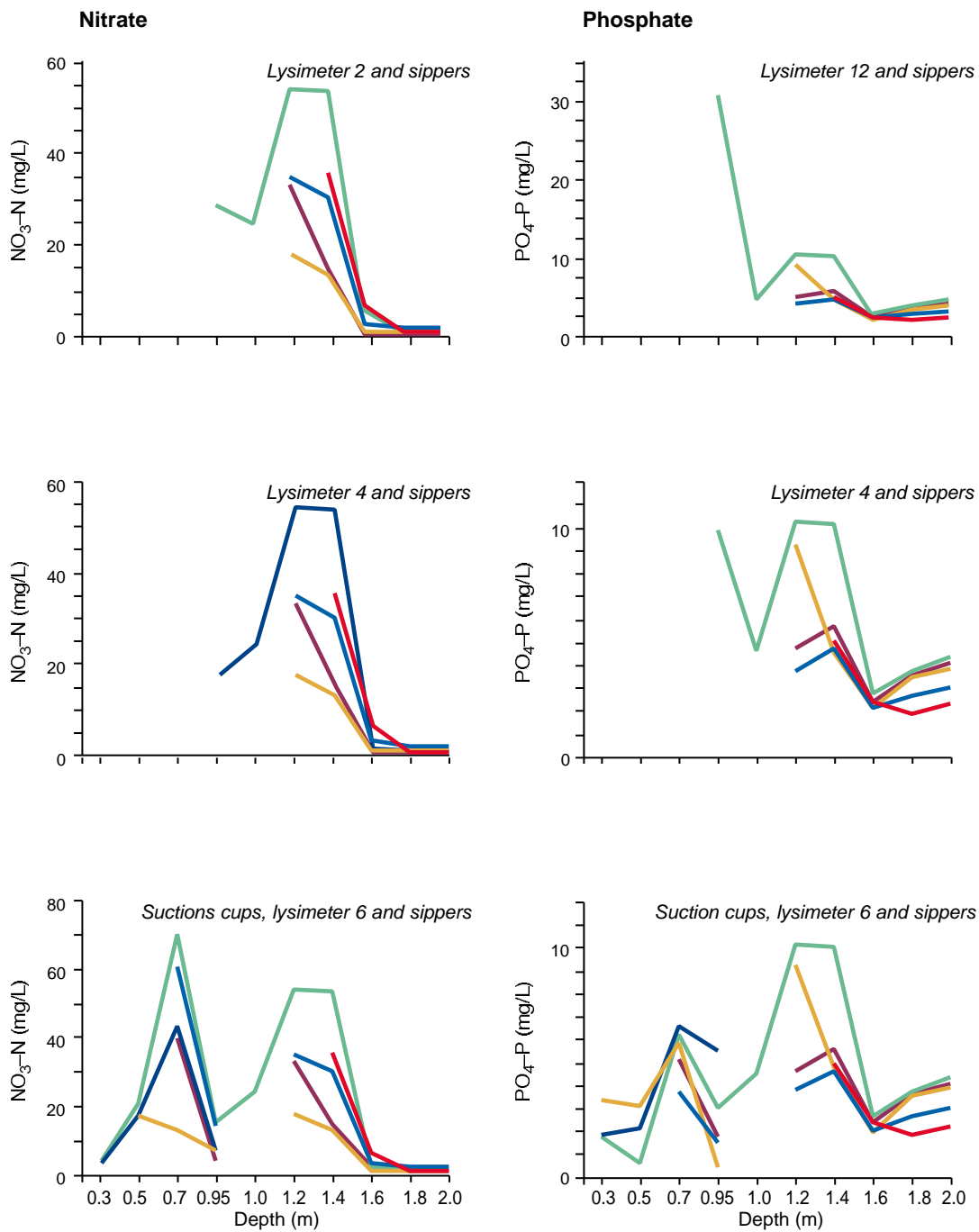
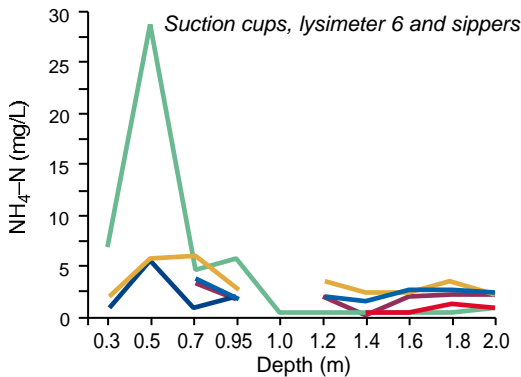
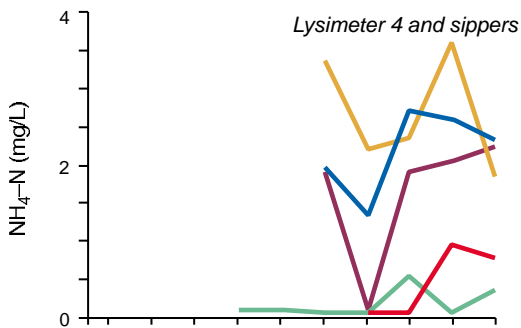
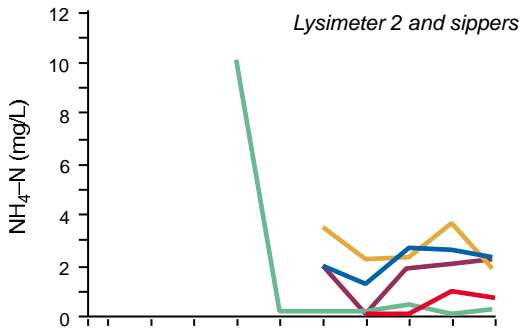

Figure 12. Distribution of NO₃, PO₄ and NH₄ in the interbeds at the strawberry farm.

Ammonium



Conclusions

Different methods were used to sample soil water and groundwater from the unsaturated and saturated zones of two experimental sites in the Gngagara Mound. The results show that most of the irrigation water reaches the watertable at the rate of 6–15 mm. Total recharge from irrigation ranged from 26 to 62 per cent of irrigation water. Ammonium and nitrate concentrations in the leachate increased with time and depth, phosphate was relatively high near the surface and decreased with depth, and pesticides were filtered in the top 1–5 cm. The results also show that the amount of nutrients leaching to the aquifer depends on application rates. Even when smaller amounts of nutrient were applied, 36 per cent of the N and 26 per cent of the P passed the root zone in the strawberry farm; in the turf farm, the corresponding figures were 33 and 8 per cent.

References

- Ahmed, M., Sharma, M.L. and Richards, Q.D. 1996. Evaluation of field sampling methods for soil water quality. *In*: Aminuddin, B.Y., Sharma, M.L., and Willett, I.R., eds., Agricultural impacts on groundwater quality. Proceedings of an international workshop held in Kota Bharu, Kelantan, Malaysia, 24–27 October. ACIAR Proceedings No 61, 64–70.
- Salama, R.B., Pollock, D. and Byrne, J. 1999. Experimental and modelling results of pesticide leaching in agricultural systems: Examples from Thailand, Malaysia and Australia. Solutions and Innovations. Proceedings of International Conference on Diffuse Pollution, Perth, Western Australia, 16–20 May.
- Salama, R.B., Pollock, D. and Byrne, J. 2001. Modelling pesticide and nutrient transport in the Gngagara Mound. These Proceedings.

Modelling Pesticide and Nutrient Transport in the Gnangara Mound

R.B. Salama, D.W. Pollock and J.D. Byrne¹

Abstract

The major agricultural activity in the Gnangara Mound area is intensive horticulture, predominantly for vegetables, native and greenhouse flowers, citrus, avocados, stone fruit, grapevines, turf and nursery crops. These industries depend heavily on pesticides and nutrients for the production and protection of their produce. The excessive use of such agrochemicals is threatening the groundwater resources of the Mound. A detailed field study was conducted of the filtration capacity of the main soil-types of the Spearwood and Bassendean Sands on which most of these activities are taking place. Two experimental sites were established in agricultural areas to monitor nutrients and pesticides in groundwater under agricultural areas. The monitoring was conducted using different techniques (lysimeters, suction cups, multi-level samplers, and shallow groundwater piezometers). None of the tested pesticides were detected in the groundwater samples collected by the different techniques from depths ranging from 30 cm to 2.0 m. These results were similar to the modelling results which showed that most of the pesticides are highly sorbed to the organically-rich soils and are therefore not leached below the top 10 cm layer. Some pesticides leach very quickly below one metre, but due to their short half-life they also degrade quickly and the amount remaining in the soil after the first week of application is very small. Atrazine, on the other hand, has higher sorption, but it persists for a long time in the soil due to its long half-life; in most cases, small amounts are leached to groundwater. A Microsoft Access database has been established for the different pesticides, soils and water properties. Hornsby Index (HI) and Attenuation Factor (AF) models were used to screen the suite of pesticides used. The pesticides with high leaching potential were modelled using CMLS and LEACHP to monitor their movement in the unsaturated zone. LEACHN was used to monitor the movement of nutrients in the unsaturated zone and to model the effect of applying different scenarios to reduce the leaching of nitrates.

THE GNANGARA MOUND is the largest groundwater body in Perth, and the superficial aquifer is the most important in the Mound. It is a complex, unconfined, multi-layered aquifer. The sediments which constitute the superficial aquifer range from predominantly clayey in the east, through a sandy succession (Bassendean Sand and Spearwood Sand) in the central coastal plain area, to sand and limestone (Tamala limestone) in the coastal belt (Davidson 1995). The geological formations provide the main basis for dividing the soil-mapping units into three dune systems: Bassendean, Spearwood and Quindalup. These are characterised by distinctive geomorphology and soils that are different from the alluvial landscapes to the east and north. The Bassendean Dunes generally have low relief and minor variations in topography

with variable depth to the watertable. The landscape comprises permanent open-water lakes to ridges more than 20 m high. The Spearwood Dunes are divided mainly on the depth of soil over the limestone substrate and the incidence of karst features. The Quindalup Dunes occur mainly along the coast.

The major agricultural activity in the Gnangara area is intensive horticulture, predominantly vegetables, native and greenhouse flowers, citrus, avocados, stone fruit, grapevines, turf and nursery crops. The majority of production is situated on the sandy soils of the Spearwood and Bassendean dune systems. Intensive agriculture is the largest private user of groundwater from the Gnangara Mound. All

¹ CSIRO Land and Water, Private Bag No 5, PO Wembley, Western Australia 6913

irrigation supplies required by market gardens are withdrawn from groundwater wells. Due to the excessive use of fertilisers, the poor retaining capacity of the sandy soils, and the relatively shallow depth to groundwater in agricultural areas, nutrients are readily leached to the groundwater aquifers. Natural background NO₃-N concentrations in bores in the agricultural areas are up to 88 mg/L; however, P concentrations are relatively low (median 0.02 mg/L) (Sharma et al. 1991). Several pesticides, notably atrazine and diazinon, have been detected in groundwater from the Gngangara Mound.

Pesticides adversely affect on crop quality and soil health, and have potential to leach and contaminate surface and groundwater resources. The international study involving Australia, Malaysia and Thailand, of which the current study is part, aims to identify and evaluate promising technologies and management options for minimising agrochemical contamination of water resources. The main objectives of the current study are to monitor nutrients and pesticides leaching using different sampling techniques, and to utilise the data to calibrate and validate pesticide-leaching models. The results from the experimental sites have been reported in a companion paper. This paper reports on modelling the effect of applying different management scenarios on the leaching of pesticides and nutrients (Salama, Byrne and Pollock 2001).

Methods

The two experimental sites were located on the Gavin and Joel sands of the Bassendean Dune System sands series, where the groundwater is within two metres of the soil surface and the subsoil has a cemented iron-humus podsol associated with the watertable. The average bulk density of these sands is 1.5 g/cm³ with a greater than 98 per cent sand fraction within virgin soil.

The two sites were installed with free-drainage lysimeters and ceramic suction cups below the beds and under the inter-bed areas in the strawberry farm, and under the turf in the turf farm. A set of multi-level groundwater sampling tubes was installed next to the lysimeters. Data loggers and water-level probes were installed in piezometers to monitor water-level changes in both sites. Irrigation is via two metered overhead sprinklers, two metered 15 mm slotted irrigation lines, and by rainfall. Rainfall events and amounts were recorded by a 0.2 mm tipping-bucket rain gauge. Lysimeters, suction cups, groundwater sampling tubes and piezometers were sampled seven times from 19 September to 17 November 1997. Soil samples were taken from various depths with an alloy

tube. The results of the experimental sites are described in detail in another paper (Salama, Pollock and Byrne 1999).

Description of models

Hornsby Index (HI) and Attenuation Factor (AF) models were used to screen the suite of pesticides commonly used in the Mound. The pesticides with high leaching potential were modelled using CMLS and LEACHP to monitor their movement in the unsaturated zone.

Hornsby Index (HI)

This index measures pesticide leaching potential (Hornsby 1992). The smaller the index, the more likely the pesticide will not be filtered but will leach to the groundwater. The derivation is:

$$HI = (K_{oc} / t_{1/2}) \times 10$$

where

K_{oc} is the organic carbon sorption coefficient

$t_{1/2}$ is pesticide half-life.

AF model

This index is equivalent to the fraction of the applied pesticide mass that is likely to leach past the chosen reference depth, d (Rao and Alley 1993). The value varies between 0 and 1, with larger values indicating a greater contamination potential. The model assumes first-order decay. The derivation is:

$$AF = \exp \frac{-0.693dRF_{FC}}{qt_{1/2}}$$

where

d is the distance from the surface to groundwater

RF is the retardation factor

FC is the volumetric water content at field capacity

q is net groundwater recharge.

RF , the retardation factor accounting for pesticide sorption effects, is given by:

$$RF = 1 + \frac{f_{oc}K_{oc}}{FC}$$

where

b is the soil bulk density (g/cm³)

f_{oc} is fraction of organic carbon.

CMLS model

This is a relatively simple model (Nofziger et al. 1998). It estimates the depth of the peak concentration of a pesticide, and calculates the relative amount of chemical in the soil profile as a function of time after application. The model assumes piston flow and ignores molecular diffusion and hydrodynamic dispersion.

LEACHP

This is the pesticide model in the LEACHM suite (Hutson and Wagenet 1992). It is a mechanistically-based model of water and solute movement and pesticide chemistry. In common with most other models of pesticide movement, it simulates pesticide transformations using first-order kinetics. It has a flexible system for tracking daughter products. The principal difference between LEACHP and simpler models such as CMLS is that water movement is simulated using a numerical solution to Richards' equation in LEACHP, so the model must be supplied with functions to describe water retention and hydraulic conductivity.

The other difference is that LEACHP can simulate the transformation and degradation of the pesticides. Transformation of pesticides in soil can occur through biotic and abiotic ways. In most cases, the pesticides degrade or transform into harmless end-products. However in some cases the metabolites are more toxic than the parent compound and these may increase the toxicity hazard.

Modelling of Pesticide Characteristics

Simple models (Hornsby Index and Attenuation Factor) were used to screen pesticides to indicate those compounds likely to be problematic for water resources. More complex models (CMLS, LEACHP, and regional models) were then used to assess selected pesticides to monitor their movement in the unsaturated zone. Model predictions were then compared with results from the field sites.

Hornsby Index

The results of the analysis of the Hornsby index (Table 1) showed that monocrotophos, dicamba salt, carbofuran, pentachlorophenol, metalaxyl, methamidophos, trichlorfon, aldicarb, metribuzin, atrazine, bentazon, fenarimol, 2,4-D acid, ethoprop, dimethoate and lindane all have high leaching potential.

AF model

The AF model was used to screen the highly leachable pesticides. Four different types of soils were used (Table 2). Although some other soils had a higher organic carbon content than the selected soils, those with the lowest organic carbon were used as these are the most vulnerable to leaching of pesticides.

For each soil, the pesticides lying below the specific soil line in Figure 1 have relatively low potential for contaminating groundwater, because they have sufficiently long residence time or short half-life, or both (Rao and Alley 1993). Those pesti-

Table 1. Leaching potential of the most commonly used pesticides.

Pesticide	Sorption (K _{oc})	Half-life (days)	Leaching Potential (Hornsby Index (HI))
High leaching			
monocrotophos (1)	1	30	0
dicamba salt (2)	2	14	1
carbofuran (7)	22	50	4
pentachlorophenol (9)	30	48	6
metalaxyl (12)	50	70	7
methamidophos (3)	5	6	8
trichlorfon (4)	10	10	10
aldicarb (8)	30	30	10
metribuzin (13)	60	40	15
atrazine (15)	100	60	17
bentazon sodium salt (10)	34	20	17
fenarimol (19)	600	360	17
2,4-D acid (5)	20	10	20
ethoprop (ethoprophos) (14)	70	25	28
dimethoate (6)	20	7	29
lindane (22)	1100	400	28
Intermediate filtration			
linuron (17)	400	60	67
prometryn (18)	400	60	67
alachlor (16)	170	15	113
dieldrin (33)	12 000	1000	120
aldrin (28)	5000	365	137
mevinphos (11)	44	3	147
diazinon (21)	1000	40	250
fenbutatin oxide (27)	2300	90	256
mancozeb (25)	2000	70	286
chlorothalonil (23)	1380	30	460
iprodione (20)	700	14	500
chlordan (35)	20 000	350	571
MCPA dimethylamine (26)	2000	25	800
heptachlor (36)	24 000	250	960
trifluralin (31)	8000	60	1333
fenvalerate (30)	5300	35	1514
High filtration			
endosulfan (34)	12400	50	2480
DDT (38)	2 000 000	2000	10 000
methyl parathion (29)	5100	5	10 200
bromoxynil octanoate (32)	10 000	7	14 286
malathion (24)	1800	1	18 000
permethrin (37)	100 000	30	33 333

Note: Numbers between brackets refer to numbers in Figure 1.

cides that lie above the line have relatively large contamination potential, because they degrade slowly or leach rapidly, or both. Using these criteria, the results of modelling the four types of soils showed that the Gavin soils have high filtration potential and only two pesticides, carbofuran and metalaxyl seem to have the potential to leach through them. In the

Table 2. Soil characteristics from the Gngangara Mound used in AF modelling.

Soil-type	Characteristic		
	Bulk Density (g/cm ³)	Fraction of Organic Carbon	Volumetric Field Capacity (%)
Karrakatta Yellow (Ky)	1.62	0.0010	0.31
Spearwood Sand (Sp)	1.59	0.0016	0.30
Gavin (G)	1.52	0.0045	0.35
Jandakot (Ja)	1.62	0.0014	0.32

Table 3. Model soil parameters used to run the LEACHP model.

Parameter	Soil Layer	Bassendean Sands				Spearwood Sands		
		G (Bb)	G (P)	Ja	J	Kls	Ky	Sp
OC	topsoil	2.94	4.80	1.02	2.90	1.05	0.82	2.50
	subsoil	0.56	0.66	0.14	0.89	0.48	0.49	0.25
v	topsoil	0.45	0.50	0.38	0.52	0.43	0.36	0.48
	subsoil	0.37	0.40	0.35	0.39	0.41	0.42	0.40
BD	topsoil	1.480	1.379	1.458	1.229	1.386	1.387	1.220
	subsoil	1.535	1.489	1.601	1.488	1.599	1.568	1.562
K	topsoil	1480	2380	562	2140	6380	2850	422
	subsoil	3410	3100	6120	4260	4410	4770	3630

Notes: **Parameters**

OC = Organic Carbon (%), v_v = volumetric water content (%), BD = bulk density (g/cm³), K = hydraulic conductivity (mm/d)

Soil Systems & Units

Bassendean Dunes: G = Gavin, Ja = Jandakot, J = Joel

Spearwood Dunes: Kls = Limestone, Ky = Karrakatta Yellow, Sp = Spearwood

Landuses

Bb = Banksia bush, P= pines.

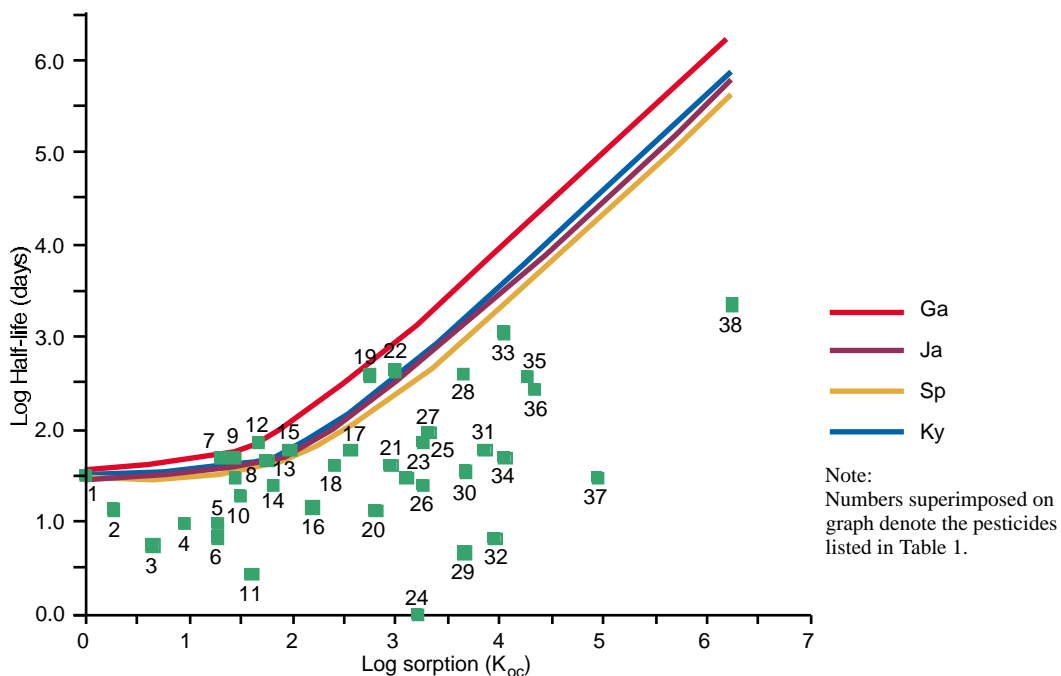

Figure 1. Soil-type control on pesticide attenuation in the Gngangara Mound.

Table 4. Model pesticide parameters used to run LEACHP.

Parameter	Atrazine	DEA	DIA	Fenamiphos	F sulfoxide	F sulfone	Fenarimol	Prometryn	Simazine
Solubility (mg/L)	33	33	33	330	330	330	14	33	6.2
Degradation 1				0.0010	0.0200	0.0250	0.0019	0.0116	0.0116
Degradation 2				0.0010	0.0050	0.0500	0.0019	0.0116	0.0116
Transformation 1	0.014	0.210		0.500	0.005				
Transformation 2	0.003	0.038		0.020	0.005				

Spearwood and Jandakot sands that have lower filtration capacity, an additional four pesticides have the potential of leaching through. These are fenarimol, lindane, atrazine and pentachlorophenol. The Karrakatta soils have the least capacity of filtering pesticides and two additional pesticides (metribuzin and monocrotophos) have the potential to leach through it. All the other pesticides used in the Gngangara Mound do not have the potential to leach through the different soils. On the other hand, if the organic carbon of the soil were increased by one per cent, which is the case in several areas, all these pesticides would be filtered in the top 20 cm.

CMLS

This was used to model leaching of commonly used pesticides in Australia using soil data from the two farms in the Gngangara Mound. The results showed that malathion, diazinon, endosulfan, iprodione, benomyl, thiram and chlorpyrifos are all highly adsorbed to the Gngangara soils and are not leached below the top 10 cm layer of the soil. On the other hand, dicamba and dimethoate leach very quickly to below one metre but, due to their short half-lives, they degrade quickly and the amount remaining in the soil after the first week of application is very small. Atrazine on the other hand has higher sorption than dicamba and dimethoate, but due to its long half-life, persists for a long time in the soil so in most cases small amounts of the pesticide are leached to groundwater.

In the field study, using recommended application rates, none of the tested pesticides (atrazine, diazinon, dimethoate, endosulfan, fenamaphos, iprodione, malathion, and chlorpyrifos) were detected in the groundwater samples collected by the different techniques from depths ranging from 30 cm to 2.0 m. This largely confirms the modelling results.

Modelling of Management Scenarios

Scenarios to reduce pesticide leaching

The LEACHP model was used to simulate the leaching of pesticides used in the two farms in the Gngangara Mound. Atrazine and its two daughters, desethylatrazine (DEA) and desisopropylatrazine

(DIA), fenamiphos and its two daughters, fenamiphos sulfoxide and fenamiphos sulfone, fenarimol and prometryn were modelled for the three main Spearwood soils where most of the agricultural activity takes place. Tables 3 and 4 detail the soil and pesticide properties used to run the model.

Several simulations were carried out to find out the effect of the different management scenarios on the leaching of the pesticides. In a test-run scenario, the applied pesticide was reduced by half. The results showed that reducing the pesticide by half will reduce the chemical content and flux by half. Four scenarios were applied:

- applied irrigation is the recommended rate of 100 per cent of pan evaporation
- irrigation applied by the farmers (11mm/day)
- organic carbon is doubled (2OC), with irrigation water of Scenario 1
- organic carbon is doubled, with irrigation water of Scenario 2.

The results showed that by applying Scenario 1 (optimum irrigation rates), the travel time of the pesticide will increase and a higher proportion of the pesticide will be retained in the top layer, thus giving it more chance to degrade. Ky soils have a high filtration capacity to all the modelled pesticides followed by the Kls, while the Sp has the lowest filtration capacity. The results also showed that even at the recommended irrigation rates (Scenario 1) the daughter products, DIA and fenamiphos sulfoxide, are more leachable and more persistent than their parent compounds. Fenamiphos sulfoxide has the earliest breakthrough curve and the highest amount of leaching below the 80 cm subsurface layer (Table 5). As expected, Scenario 3 (double organic carbon) gave the best results with minimal pesticide breaking through the 80 cm layer.

Under excessive irrigation (Scenario 2), atrazine persisted for 100 days in Kls topsoil, and for less than 200 days in the subsoil (Table 6). It leached below the topsoil in about 100 days in Ky, and persisted in the subsoil for more than 200 days. Atrazine daughter products disappeared from the topsoil of Ky after nearly 100 days, and persisted in the subsoil for about 200 days. Atrazine persisted for a shorter time in Sp, as much of it leached below the subsoil.

Table 5. Pesticide leaching through 80 cm layer in Spearwood sands.

Scenario	Fenamiphos Sulfoxide, by Soil-type (%)		
	Kls	Ky	Sp
1	47	39	61
2	74	68	81
3	33	27	63
4	64	59	81

Table 6. Pesticide remaining in the topsoil and subsoil after 100 days in Spearwood sands.

Scenario	Atrazine by Soil Layer & Type (%)					
	Topsoil			Subsoil		
	Kls	Ky	Sp	Kls	Ky	Sp
1	12	10	27	37	43	16
2	2	3	8	13	20	9
3	21	19	7	24	31	36
4	6	5	14	33	39	19

Atrazine and its two daughters, DEA and DIA, and simazine were also modelled for the three main soils in the Bassendean sands, Gavin, Jandakot and Joel. Two simulations were carried out for the Gavin soils, one under pines and the other under native Banksia. The results showed that due to the absence of irrigation and the low water content of the surface and subsurface soil horizons (due to the plant water uptake), atrazine did not leach below the subsurface zone and most of the herbicides were filtered on the top surface layer (Table 7). Smaller amounts of simazine, which is more mobile than atrazine, passed below the subsoil (Table 8).

Table 7. Pesticides breaking through the 80 cm layer in Bassendean sands.

Pesticide Name	Pesticide, by Soil-type (%)			
	Gavin (Bb)	Gavin (P)	Jandakot	Joel
atrazine	0	0	8	0
desethylatrazine	0	0	3	0
desisopropylatrazine	1	0	17	0
simazine	4	20	24	12

Table 8. Pesticide remaining in topsoil and subsoil after 100 days in Bassendean sands.

Soil Layer	Atrazine by Soil-type & Layer (%)			
	Gavin (Bb)	Gavin (P)	Jandakot	Joel
topsoil	37	40	30	36
subsoil	2	0	14	1

Scenarios to reduce nutrient leaching

The LEACHN model was used to simulate the leaching of nitrogenous fertilisers as applied to both urban and agricultural areas. The model was also used to simulate several management scenarios of fertiliser and irrigation applications.

Table 9. Recommended application rates of fertilisers used in the LEACHN model.

Application Date	Fertiliser (kg/ha)		
	Urea	NH ₄	NO ₃
12/05/98	00.00	27.20	26.90
26/05/98	00.00	13.60	21.70
09/06/98	00.00	13.60	21.70
23/06/98	00.00	00.00	26.90
07/07/98	00.00	00.00	26.90
21/07/98	00.00	00.00	26.90
04/08/98	00.00	17.00	16.80
18/08/98	00.00	17.00	16.80
01/09/98	00.00	17.00	16.80
15/09/98	18.40	00.00	26.40
29/09/98	18.40	00.00	26.40
13/10/98	04.60	00.00	30.30
27/10/98	04.60	00.00	30.30
10/11/98	04.60	00.00	30.30
24/11/98	00.00	00.00	26.70
09/12/98	00.00	00.00	26.70
23/12/98	00.00	00.00	33.60

In the urban area, ammonium was applied twice during the dry season at the rate of 70 kg/ha, while irrigation was applied at the rate of 3 mm every second day. The results showed that ammonium disappears from the top layer in less than 50 days in all three types of soils: Kls, Ky and Sp. Also after 100 days, 600 mg/m² of nitrate leaches to the 50–80 cm layer in Kls, 1000 mg/m² in Ky, and 300 mg/m² in Sp.

Table 10. Nitrate leaching below 80 cm after 250 days.

Scenario	NO ₃ -N, by Soil-type (kg/ha)		
	Kls	Ky	Sp
I	360	300	330
II	480	410	460
III	16	120	150

In the horticulture area, three scenarios were applied, the results of which are shown in Tables 10 and 11.

Scenario I

The recommended rates of fertilisers were applied (Table 9), and the irrigation was also the recommended rate of 100 per cent pan evaporation.

Scenario II

The irrigation rate was increased to 11 mm/day, which is the level used by the farmers. The farmers apply

Table 11. Ammonium and nitrate in various layers after 250 days.

Scenario	Sample Depth (cm)	NH ₄ -N & NO ₃ -N, by Soil-type (mg/m ²)					
		KIs		Ky		Sp	
		NH ₄ -N	NO ₃ -N	NH ₄ -N	NO ₃ -N	NH ₄ -N	NO ₃ -N
I	0–20	250	1800	250	1800	400	2800
	20–50	250	2600	350	3600	350	3000
	50–80	10	2600	100	2900	0	500
II	0–20	60	250	50	400	100	400
	20–50	100	510	150	1200	120	600
	50–80	60	850	100	1300	60	1100
III	0–20	160	800	150	800	180	1400
	20–50	160	1300	160	1600	160	1500
	50–80	0	1300	50	1450	0	1750

sprinkler irrigation two or three times per day for water supply and for cooling during the hot summer days.

Scenario III

The fertiliser application rate was decreased to half the recommended application rate, while keeping the irrigation rate at pan evaporation.

By increasing the rate of water application (Scenario II), most of the nutrients were leached below the topsoil horizons as shown by the lower nutrient content in all three layers by comparison with the other two scenarios.

Scenario III, where half the amount of fertiliser was applied together with the pan evaporation water, caused the least amount of nutrients to leach through the 80 cm layer. Of the three soils, KIs was the best soil for retaining most of the nutrients; only 16 kg/ha passed through the 80 cm layer, while 120 kg/ha passed through Ky, and 150 kg/ha passed through Sp.

Conclusions

Most of the reported incidents of pesticides in groundwater are caused by excessive application of pesticides or excessive irrigation, or both. In Australia, most of such incidents are due to malpractice or misadventure such as a spill. The results of this study showed that in normal use only a small number of pesticides have the potential to contaminate the Gngangara Mound aquifer. Furthermore with proper management the risk of contamination could be greatly reduced. Reducing the application rates of pesticides to the recommended rates and adopting better irrigation practices will minimise contamination potential. Increasing the organic matter of the top 10 cm would greatly enhance the filtering capacity of the soils, and in most cases none of the pesticides would leach down to the aquifer.

This study suggests that indicate that the most effective management to reduce nutrients leaching is by reducing fertiliser application rates and applying the optimum irrigation rates. The Karrakatta limestone sand appears to be the best soil to retain most of the nutrients.

References

- Davidson, W.A. 1995. Hydrogeology and Groundwater Resources of the Perth Region, Western Australia. Geological Survey of Western Australia, Bulletin 142, 257pp.
- Hornsby, A.G. 1992. Site-specific pesticide recommendations: the final step in environmental impact prevention. *Weed Technology* 6: 736–742.
- Hutson, J.L. and Wagenet, R.J. 1992. LEACHM: Leaching Estimation and Chemistry Model. Version 3. Cornell Univeristy, New York.
- Nofziger, D.L., Chen, J.S., Wu, J., Ma, F. and Hornsby, A.G. 1998. The chemical movement in layered soils. Model for batch processing. Division of Agricultural Sciences and Natural Resources, Oklahoma State University.
- Rao, P.S.C. and Alley, W. M. 1993. Pesticides. In: Alley, W.M., ed., Regional Groundwater Quality. VNR, New York, 345–382.
- Salama, R.B., Byrne, J.D. and Pollock, D.W. 2001. Nutrient and pesticide leaching in experimental sites in the Swan Coastal Plain. These Proceedings.
- Salama, R.B., Pollock, D. and Byrne, J. 1999. Experimental and modelling results of pesticide leaching in agricultural systems: Examples from Thailand, Malaysia and Australia. Solutions and Innovations. Proceedings of International Conference on Diffuse Pollution, Perth, Western Australia, 16–20 May.
- Sharma, M.L., Byrne, J.D.M., Herne, D.E. and Kin, P.G. 1991. Impact of horticulture on water and nutrient fluxes to a sandy aquifer. CSIRO Division of Water Resources Report No. 91/33.

Regional Vulnerability to Nutrient Leaching in the Gngangara Mound under Different Management Scenarios

R.B. Salama, D.W. Pollock and J.D. Byrne¹

Abstract

Regional groundwater vulnerability maps that indicate the impact of leaching of nutrients under different management scenarios were prepared for the Gngangara Mound using the LEACHN model and GIS techniques. The results were up-scaled using soil maps under three different management scenarios and different rates of fertiliser application. In the first scenario, the optimum recommended rate of fertiliser application and recommended irrigation rate of 100 per cent pan evaporation were applied. In the second scenario, the application of fertiliser was the same as in the first, but the irrigation rate was increased to 11 mm/day, which is the level used by the farmers. In the third scenario, the fertiliser application rate was decreased to half the recommended application rate while keeping the irrigation rate at pan evaporation. Vulnerability to nutrient leaching was highly dependent on the rate of fertiliser application and the amount of irrigation water. In the urban areas, the amount of NO₃-N leaching below the 80 cm horizon was not more than 50 kg/ha in all three scenarios; but due to the larger areas involved compared with the agricultural area, the total load that reaches the groundwater from urban areas would be more. Regionally, nitrate was found to be above the limit in eight sites, mainly in the horticultural areas on Spearwood sands.

THE SANDY SOILS of the Gngangara Mound are highly porous, and usually of very high permeability and low organic matter content. Excessive amounts of nutrients are used in the agricultural areas to compensate for losses due to leaching by excess irrigation and rain. High levels of nitrate-N concentrations are reported in groundwater below horticultural properties.

Increasing inputs of organic and inorganic fertilisers in urban and agricultural areas are causing an increase in the amount of nutrients leached into groundwater in the Gngangara Mound aquifers. Nitrate-N usually leaches rapidly through the sandy soils to the groundwater, especially when the groundwater is near to the surface. On the other hand, phosphorus is adsorbed strongly in the topsoils that have higher clays and organic matter and does not leach as well as nitrogen. The main sources of nitrate on the Gngangara Mound are: agriculture, grazing, horticulture, and semi-rural or urban developments; the latter includes septic systems, unsewered or sewerred resi-

dential areas, lawns, gardens, parks, fertilisers applied to sports grounds, and leachate from landfills.

The rate of fertiliser application varies considerably between private lawns, public parks and market gardens. At the same time, irrigation water is applied at different rates and at different times, which makes the rates of recharge from irrigation from these different situations very variable.

Method and Results

This study takes into account results from a previous study for nutrient leaching and balances in urban areas (Sharma et al. 1995), as well as recent data collected from market gardens, and studies of phosphorus and nitrate loss from horticulture on the Swan Coastal Plain (Lantzke 1997). The nutrient balances were used to calibrate the LEACHN model and to study the regional distribution of leaching.

¹ CSIRO Land and Water, Private Bag No 5, PO Wembley, Western Australia 6913

Nutrient leaching in urban and horticultural areas, and the region

Urban areas

In urban areas leached nitrogen was measured in the form of $\text{NO}_3\text{-N}$ and $\text{NH}_4\text{-N}$. Leaching was higher in summer than in winter, and at most sites $\text{NO}_3\text{-N}$ concentrations approached or exceed UN World Health Organisation drinking-water limits during some parts of the year (Sharma et al. 1995). Leaching on Bassendean sands was higher than on the Spearwood sands.

The ratio of N_{out} (output in leachate) to N_{in} (input through fertiliser and irrigation) varied considerably from site to site, ranging from 0.09 to 0.30. Much higher proportions of applied N were found to be leaching beneath Bassendean sands (about 23 per cent) than under Spearwood sands (about 10 per cent). Over this period, public sites generally received far less N input (135 kg/ha) than private sites

(350 kg/ha), yet the average yields in leachate were similar (public, 31; private, 39 kg/ha). This resulted in a much higher $N_{\text{out}}/N_{\text{in}}$ ratio for public (0.23) than private sites (0.12). Most of the fertiliser was applied during summer, so N concentrations in leachate were significantly higher in summer than in winter (Tables 1 and 2).

The long-term average phosphate concentrations were much higher in the Bassendean sands (0.81 mg/L) than the Spearwood (0.015 mg/L), due to the higher adsorption capacity of the latter (Gerritse, Barber and Adney 1990). Higher than expected phosphorus concentrations were encountered from the Corderoy site, attributed to previous higher applications (Barber et al. 1991). The lower than expected phosphorus levels in one of the Bassendean sites was attributed to recent establishment of the site, meaning that P is still being adsorbed in the soils (Sharma et al. 1995).

Table 1. Water balance for urban and horticultural sites.

Site	Inputs (mm)				Outputs (mm)		Ratios			
	R	P	I	IT	Et	Ep	R/IT	I/IT	IT/Ep	Et/Ep
Urban										
Noranda	846	849	1413	2262	1416	2013	0.374	0.625	1.124	0.703
Tuart Hill	480	659	753	1411	931	2013	0.340	0.533	0.701	0.462
Mt Lawley	876	734	990	1724	848	2013	0.508	0.574	0.856	0.421
Karrinyup	291	723	745	1468	1177	2013	0.198	0.507	0.729	0.585
Cordeory	696	705	1193	1898	1202	2013	0.367	0.629	0.943	0.597
Balcatta	251	792	642	1434	1183	2013	0.175	0.448	0.712	0.588
Ballajura	1205	848	1543	2392	1187	2013	0.504	0.645	1.188	0.590
Waterman	265	654	769	1423	1158	2013	0.186	0.541	0.707	0.575
Horticultural										
Strawberry farm	226.0	430.6	426.0	856.6	630.6	423.2	0.264	0.497	2.024	1.490
Turf farm	153.6	134.0	115.6	249.6	96.0	324.5	0.615	0.463	0.769	0.296

Notes: R = recharge, P= precipitation, I = irrigation, IT= total water input (including recharge), Et = estimated evapotranspiration, Ep = 'Class A' pan evaporation.

Table 2. Nutrient balance for urban and horticultural sites (lysimeter data).

Site	Flow-weighted Concentration (mg/L)					Yield (kg/ha)				
	$\text{NO}_3\text{-N}$	$\text{NH}_4\text{-N}$	Total N	$\text{PO}_4\text{-P}$	Cl	$\text{NO}_3\text{-N}$	$\text{NH}_4\text{-N}$	Total N	$\text{PO}_4\text{-P}$	Cl
Urban										
Noranda	4.12	0.64	4.76	0.034	129	218	33.75	251.80	1.81	6810
Tuart Hill	1.56	0.01	1.57	0.002	104	47	0.44	47.44	0.06	3113
Mt. Lawley	2.68	0.59	3.27	0.010	125	147	32.50	179.50	0.56	6857
Karrinyup	2.65	0.02	2.67	0.034	175	48	0.38	48.38	0.63	3190
Cordeory	5.33	1.10	6.43	0.040	60	232	47.81	279.80	2.00	2597
Balcatta	4.04	na	4.04	0.008	110	63	na	63.00	0.13	1733
Ballajura	5.37	0.07	5.44	0.003	38	404	5.06	409.10	0.25	2857
Waterman	0.83	na	0.83	0.015	111	14	na	14.00	0.25	1842
Horticultural										
Strawberry farm	34.62	3.22	37.84	6.740	30	61	5.67	66.69	11.88	52
Turf farm	49.56	5.39	54.95	4.320	119	84	9.19	93.64	7.37	203

Note: na = not available

In a GIS-based study carried out in a groundwater supply field in the Gnamangara Mound (Barber, Otto and Bates 1996), it was found that groundwater quality was affected by increasing nitrate. Nitrate concentrations down-gradient from older unsewered urban areas exceeded 10 mg/L NO₃-N in production wells. The study showed that the full impact of the unsewered urban development would occur in approximately 15–20 years.

Horticultural areas

High to very high NO₃-N concentrations were found in the shallow groundwater beneath the production areas in ten properties investigated by Lantzke (1997). The high NO₃-N concentrations reached the bottom of the superficial aquifer in only two properties. Due to denitrification, NO₃-N levels did not persist more than 50–100 m away from the high zones.

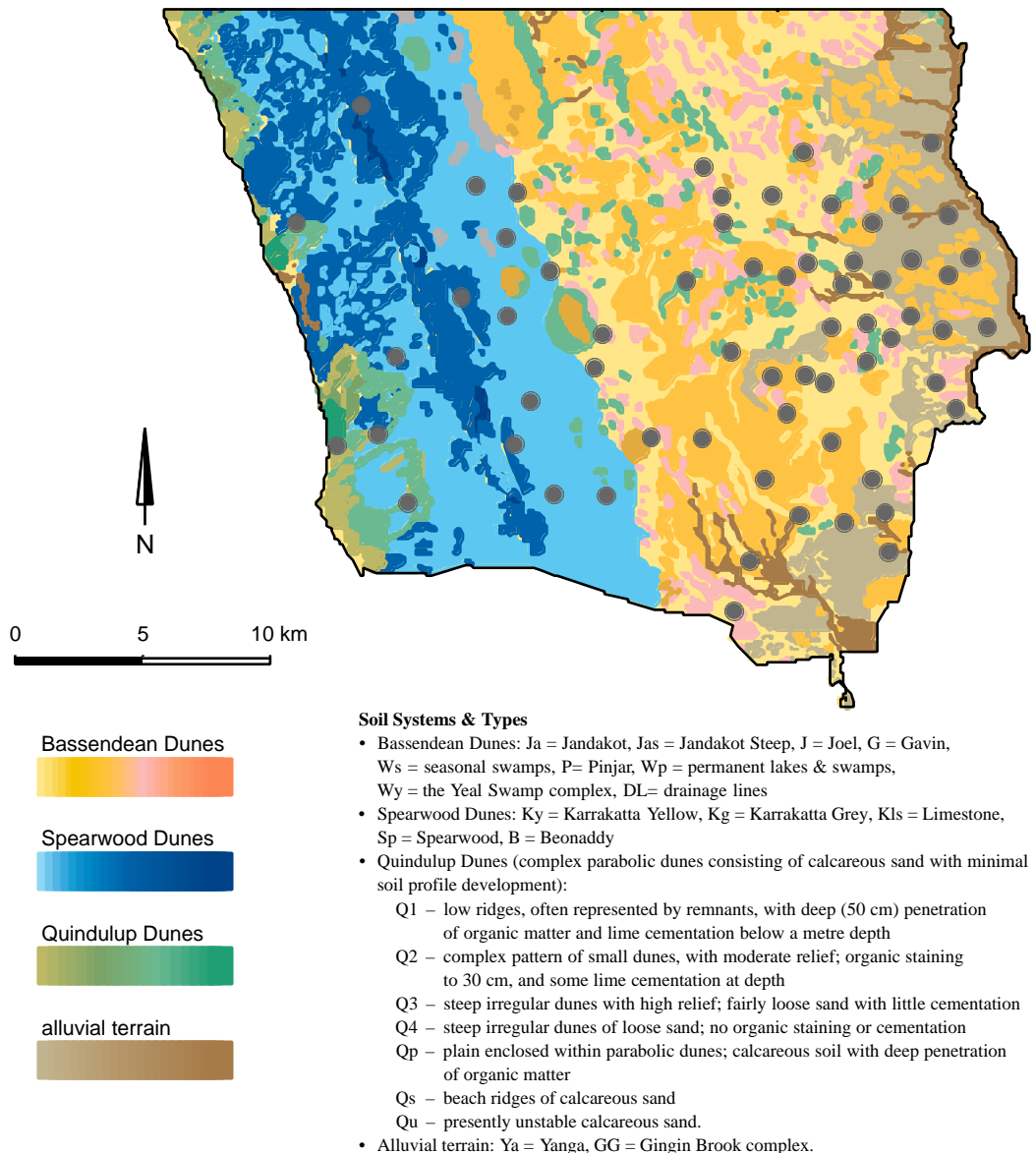
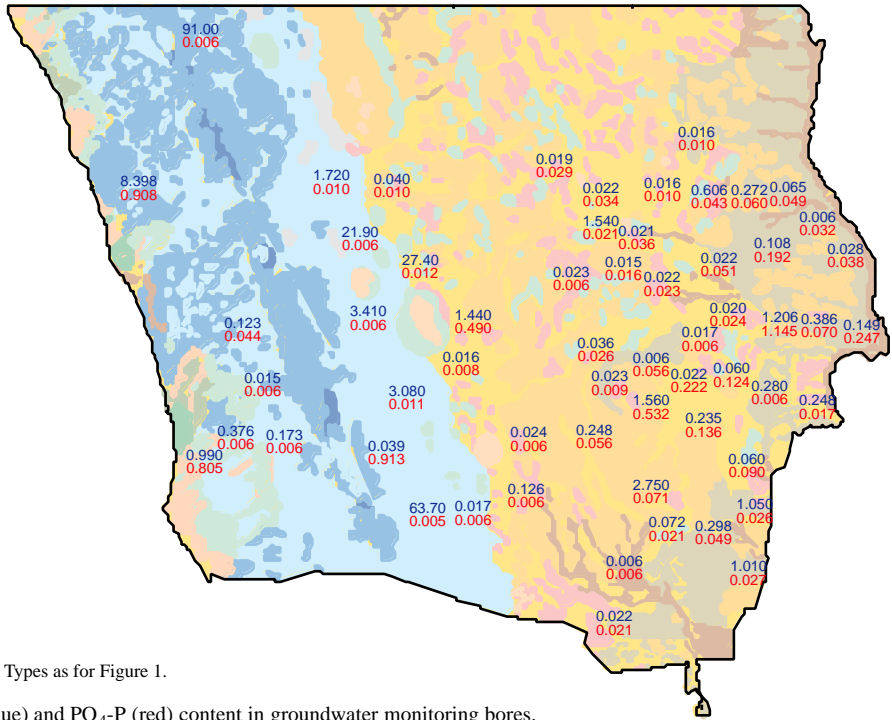

Figure 1. Groundwater sampling sites.



Note: Soil Systems and Types as for Figure 1.

Figure 2. NO₃-N (blue) and PO₄-P (red) content in groundwater monitoring bores.

Detailed studies of nutrient leaching in strawberry and turf farms were also carried out in 1998 (Salama, Pollock and Byrne 1999). The results in both locations showed that because of excessive application of nutrients, NH₄ and NO₃ leach to the groundwater at high rates. The N levels (15–54 mg/L) were above the acceptable limits in the top 1.6 m of the shallow aquifer system. This trend decreased abruptly below 2.0 m where the concentrations were <1 mg/L. Phosphorus increased with time and decreased with depth; the concentrations were 4–10 mg/L above 1.6 m, and 2–4 mg/L below that depth. Ammonium-N concentrations ranged from <1 to 4 mg/L in the top 60 cm.

The region

Groundwater nitrate-N concentrations within the Gngangara Mound and surrounding areas are generally low. In a survey of 70 private and public wells in the Gngangara Mound, most of the wells that contained high nitrate-N levels were within the horticultural areas in the Spearwood sand. In eight wells the nitrate level exceeded 10 mg/L, and in two wells it exceeded 50 mg/L (PM34 = 91 mg/L; MM14 = 68 mg/L). In two other wells the nitrate-N was equal to or more than 5 mg/L; in all the others it

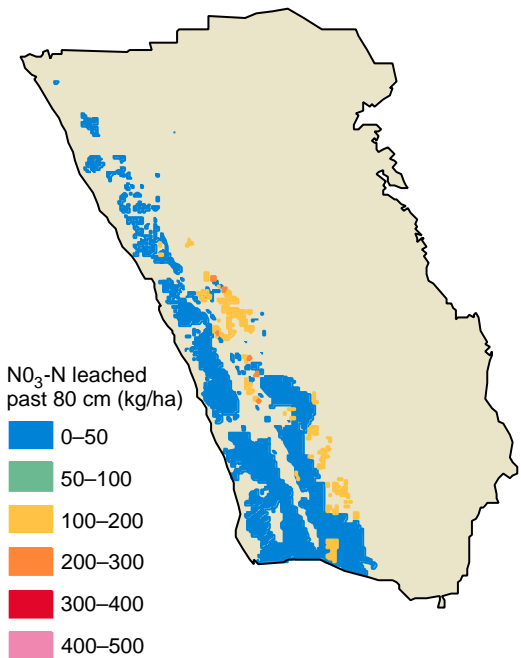

Figure 3(a). Nitrate-N leaching for Scenario 1.

was below 5 mg/L, with most below 1 mg/L. Phosphate P levels were very low in all sampled wells. Sampling sites and results are summarised in Figures 1 and 2, respectively.

Regional vulnerability to nutrient leaching

In this study, the method used GIS for mapping aquifer vulnerability, incorporating the information on soils, landform and landuse maps. The LEACHN model was used to simulate the leaching of nitrogenous fertilisers as applied to both urban and agricultural areas. The model was also used to simulate several management scenarios of fertiliser and irrigation applications.

For the urban areas, ammonium-N was applied twice during the dry season at the rate of 70 kg/ha, while irrigation was applied at the rate of 3 mm every second day. Ammonium-N disappeared from the top layer in less than 50 days in all three types of soil: Kls, Ky and Sp of the Spearwood Sands. Also after 100 days about 600 mg/m² of NO₃-N leached to the 50–80 cm layer in the Kls, 1000 mg/m² in the Ky, and 300 mg/m² in the Sp.

In the horticulture area, three scenarios were applied, the results of which are detailed in Salama, Pollock and Byrne (2001) and illustrated in Figure 3.

The scenarios are as follows.

Scenario 1:

The recommended rates of fertilisers were applied (Table 9), and the irrigation was also the recommended rate of 100 per cent pan evaporation.

Scenario 2:

The irrigation rate was increased to 11 mm/day, which is the level used by the farmers. The farmers apply sprinkler irrigation two or three times per day for water supply and for cooling during the hot summer days.

Scenario 3:

The fertiliser application rate was decreased to half the recommended application rate, while keeping the irrigation rate at pan evaporation.

Scenario 3, where half the amount of fertiliser was applied together with the pan evaporation water, shows the least amount of nutrients leaching through the 80 cm layer. Of the three soils, the Kls retained most of the nutrients, as only 16 kg/ha of NO₃ passed through the 80 cm layer, while 120 kg/ha passed in the Ky and 150 kg/ha passed in the Sp.

In Scenario 1, leaching of NO₃ in most of the horticultural areas was 300–350 kg/ha, with four sites exceeding 400 kg/ha. In Scenario 2, where higher

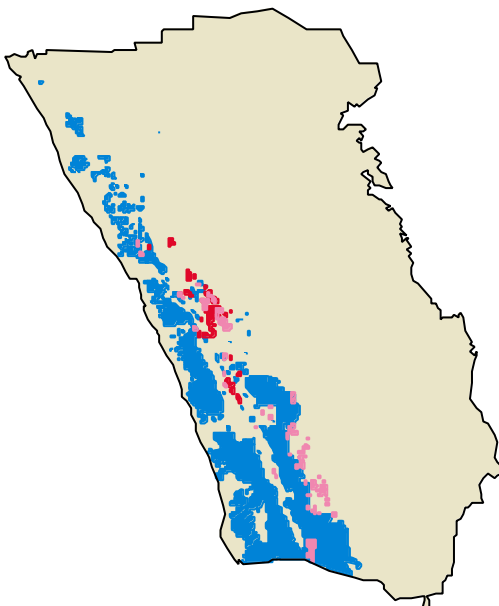

Figure 3(b). Nitrate-N leaching for Scenario 2.

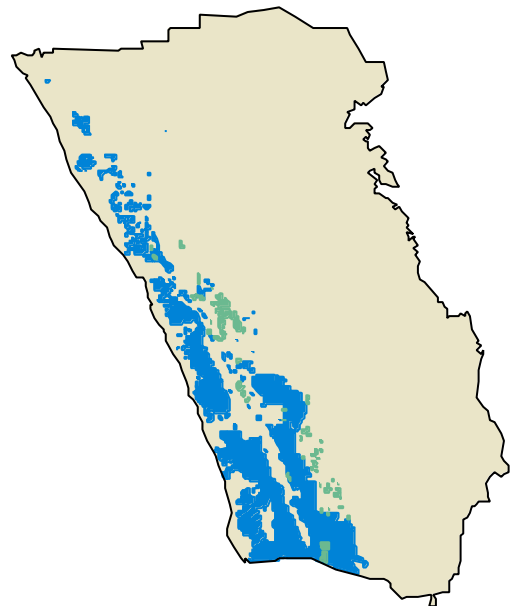
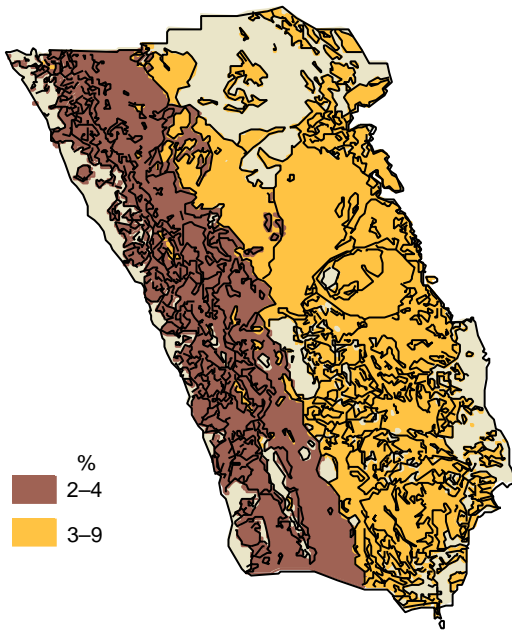

Figure 3(c). Nitrate-N leaching for Scenario 3.



Note: The blank areas on the map are regions with unknown organic carbon content, including the Quindalup Dunes and various wetlands.

Figure 4. Denitrification rates.

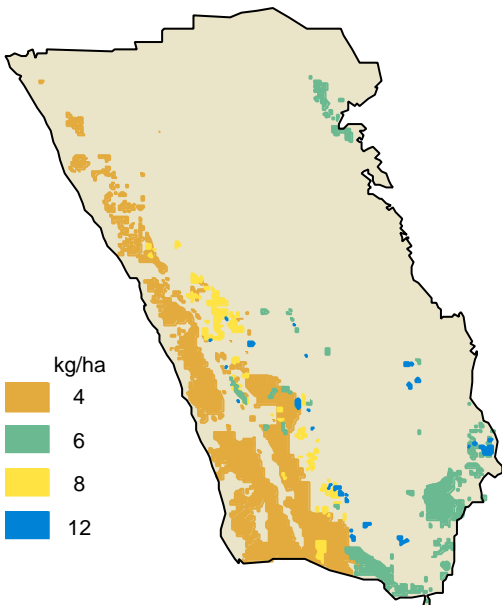

Figure 5. Denitrification amounts.

irrigation rates were used, leaching in most sites was more than 400 kg/ha, and in several sites the NO_3 leaching exceeded 450 kg/ha. When the nutrient and water applications were reduced as in Scenario 3, only 100–150 kg/ha leached below the 80 cm horizon.

In the urban areas, the amount of nitrate-N leaching below the 80 cm horizon was less than 50 kg/ha in all three scenarios; however, since the areas where fertilisers are applied are larger than in the agricultural areas, the total load which reaches the groundwater from the urban areas is likely to be higher.

Discussion

Denitrification in the unsaturated zone

The main factor affecting denitrification is availability of oxygen in soil and groundwater, which often relates to the amount of organic carbon and redox conditions. In general, the higher the water content and organic carbon content of a soil, the less oxygen the soil contains, and so the higher the denitrification rate. Meisinger and Randall (1991) devised an index which can be used to estimate the denitrification rate in a soil, based on the above properties. The organic carbon content of the main soil-types of the Gngara Mound for different landuses were used for the denitrification studies. These data are shown in Table 3.

Table 3. Organic Carbon content for different soils and landuses.

Soil-type	Organic Carbon (%)			Average
	Mg	P	V	
G	1.04	3.28	2.68	2.57
Ja	–	–	1.10	1.10
J	–	–	2.02	2.02
<hr style="border-top: 1px dashed black;"/>				
B	2.14	–	2.50	2.32
Kg	1.10	–	–	1.10
Kls	0.92	–	–	0.92
Ky	0.73	–	0.84	0.77
Sp	0.84	–	2.00	1.23

Notes: Soil Systems & Types

- Bassendean Dunes: G = Gavin, Ja = Jandakot, J = Joel
- Spearwood Dunes: B = Beonaddy, Kg = Karrakatta Grey, Kls = Limestone, Ky = Karrakatta Yellow, Sp = Spearwood

Landuses

- Mg = market gardens, P = pines, V = vegetables

The organic carbon values in Table 3 were converted to denitrification rates; organic matter values were estimated by doubling the organic carbon values shown in Table 3. The Gngangara Mound Soils are considered to be excessively well drained, therefore only the 'Excessively Well Drained' column from the Meisinger and Randall table is shown in Table 4.

Table 4. Denitrification rates for various proportions of organic matter in 'excessively well drained' soil.

Organic Matter (%)	Denitrification Rate (%)
<2	2-4
2-5	3-9
>5	4-12

Denitrification rates were estimated from the range specified in the Meisinger and Randall index. The calculations show that the Bassendean sands (G, Ja, J, Jas) had denitrification rates in the range 3-9 per cent. Of the Spearwood sands, B and Kg had denitrification rates of 3-9 per cent, while Kl, Ky and Sp were 2-4 per cent. Broadly speaking, this means that the Spearwood sands (which are located closer to the coast) have lower denitrification rates than the Bassendean sands (which are located further inland).

Figure 4 shows the clear distinction between the soils with the lower denitrification rate and those with the higher denitrification rate. The reason for this clear distinction is that the Bassendean sands generally have a higher organic carbon content and therefore higher denitrification rate than the Spearwood sands.

The other factor that needed to be considered was the amount of nitrogen applied to the soil. Different landuses require different amounts of nitrogen. For the purposes of this study, it was assumed that 140 kg/ha of N is applied annually to the soil in urban areas, and 203.2 kg/ha in market garden areas. Landuse and soil maps were then used in a GIS to produce a map of the Gngangara Mound showing the amount of nitrogen denitrified (Figure 5).

Management issues

Considerable progress has been made towards reducing pollution problems; nevertheless, it is difficult to control non-point source (NPS) pollution. This is mainly due to economic as well as regulatory difficulties that arise in the control of NPS. In most cases, NPS problems involve the use of several pesticides and nutrients from different plots, sub-catchments and catchments that can be difficult to trace back to one

user. For example, in the Gngangara Mound most of the farmers use nutrients and pesticides at excessive levels. However, only in the areas where groundwater levels are below two metres from the surface do these pollutants reach the groundwater at detectable levels. (Any detectable value is above permissible limits.) In other areas, where the groundwater is usually more than 10 m from the surface, the nutrients are greatly reduced through denitrification, dilution and dispersion.

Conclusions

Regional groundwater vulnerability maps that indicate the impact of leaching of nutrients under different management scenarios were prepared for the Gngangara Mound using the LEACHN model and GIS techniques. The results were upscaled using soil maps under different management scenarios and different rates of fertiliser application. Vulnerability for nutrient leaching was highly dependent on the rate of fertiliser application and the amount of irrigation water. In the urban areas, the amount of NO₃ leaching below the 80 cm horizon was less than 50 kg/ha in all three scenarios but, due to the larger areas where fertilisers were applied, the total load that reaches the groundwater from the urban area is likely to be more than that from the agricultural area. On the regional scale, nitrate was found to be above the limit in eight sites, mainly in the horticultural areas of the Spearwood sands.

Several alternative approaches are available for regulators to control pollution. They include taxes and charges on fertilisers and pesticides, withdrawal of leases, scaling fine system and subsidies. Most of the economic instruments normally recommended with which to target pollution were found not to be applicable in the Gngangara Mound (Nind 1997). The traditional economic paradigm assumes that there is a socially optimal level of pollution. The Nind study suggests that this point cannot be reached before growers are forced out of business.

To reduce NPS pollution, an integrated approach that includes several options is required. There is a need to change current practices and reduce fertiliser application to match crop needs. Wastes from high-density livestock operations need to be managed as a point source of pollution. Wetlands, lakes, and rivers can be used for denitrification; this will reduce the amount of nutrients leaching to the groundwater.

References

- Barber, C., Davis, G.B., Thierrin, J., Bates, L., Patterson, M.B., Pribac, F., Gibbs, R., Power, T., Briegel, D., Lambert, M. and Hosking, J. 1991. Assessment of the Impact of Pollutants on Groundwater Beneath Urban Areas. Final Report. CSIRO Division of Water Resources, Report No. 91/22, 53pp.
- Barber, C., Otto, C.J. and Bates, L.E. 1996. Evaluation of the relationship between land-use changes and groundwater quality in a water supply catchment, using GIS technology: The Gwelup wellfield, Western Australia. *Hydrogeology Journal* 4: 6–19.
- Gerritse, R.G., Barber, C. and Adney, J.A. 1990. The impact of residential areas on groundwater quality: Swan Coastal Plain, Western Australia. *Water Resources Series No. 3*. CSIRO Division of Water Resources, 26pp.
- Lantzke, N. 1997. Phosphorus and nitrate loss from horticulture on the Swan Coastal Plain. *Miscellaneous Publication 16/97, Agriculture Western Australia*, 38pp.
- Meisinger, J.J. and Randall, G.W. 1991. Estimating Nitrogen Budgets for Soil-Crop Systems. *In: Follett, R.F., Keeney, D.R. and Cruse R.M., eds., Managing Nitrogen for Groundwater Quality and Farm Profitability*. Soil Science Society of America.
- Nind, C. 1997. Economic instruments to manage groundwater pollution by pesticide leaching from vegetable growing areas on the Gnangara Mound in Perth, Western Australia. *Dissertation, Faculty of Agriculture, UWA*.
- Salama, R.B., Pollock, D. and Byrne, J. 1999. Experimental and modelling results of pesticide leaching in agricultural systems: Examples from Thailand, Malaysia and Australia. *Solutions and Innovations. Proceedings of International Conference on Diffuse Pollution, Perth, Western Australia, 16–20 May*.
- Salama, R.B., Pollock, D. and Byrne, J. 2001. Modelling pesticide and nutrient transport in the Gnangara Mound. *These Proceedings*.
- Sharma, M.L., Herne, D.E., Byrne, J.D.M. and Kin, P.G. 1995. Leaching of nutrients beneath urban lawns to an unconfined sandy aquifer. *CSIRO Division of Water Resources Report No. 95-12, 111pp*.

Regional Vulnerability to Pesticide Contamination in the Gngangara Mound under Different Management Scenarios

R.B. Salama, D.W. Pollock and J.D. Byrne¹

Abstract

The Attenuation Factor (AF) model was used to simulate the leaching potential for carbofuran for the soils of the Gngangara Mound to a depth of 100 cm under three different rates of recharge: 0.1, 0.3 and 0.6 cm/day. The LEACHP model was used to simulate four scenarios for the leaching of atrazine under different irrigation rates in pine plantations and horticultural areas. CMLS was also used to simulate travel time for atrazine to a depth of one metre. Two methods were used to upscale the modelling results: MS-VULPEST was used to upscale the AF and CMLS results; soil maps and GIS techniques were used to upscale the LEACHP results. The results showed that due to the high hydraulic conductivity of the Bassendean sands, the travel time of atrazine to reach a depth of one metre was approximately 59 days, but it was 173 days in some areas due to high organic carbon. In the Spearwood sands, the travel time was about 77–100 days. The LEACHP scenarios indicated that by applying high irrigation rates in the horticulture areas, 60–70 mg/m² of the pesticide would leach below the 80 cm layer. These results suggest that there is a potential for some pesticides to reach the groundwater aquifers, especially in the agricultural areas.

PESTICIDECONTAMINATION of shallow and deep groundwater has been recorded in many countries. It is reported that some 32 herbicides, 19 insecticides and two fungicides have been detected in groundwaters from various parts of the world (Vighi and Funari 1995). Several pesticides have been detected in groundwater from the Gngangara Mound, specifically atrazine and diazinon. However, their concentrations are well below the Australian National Health and Medical Research Council (NHMRC) guideline limits.

Groundwater vulnerability to pesticide contamination depends on several factors including physical, chemical and biological processes that determine the fate of each pesticide. The vulnerability is dependent on, and strongly affected by, spatial and temporal variations in these processes. Hydrogeomorphic Analysis of Regional Spatial Data (HARSD) methodology was used in this study as part of the overall scheme of reducing the uncertainty. HARSD partitions catchments into areas of similar hydrological and hydrogeological characteristics (Salama et al. 1997).

Vulnerability maps and vulnerability assessments are tools available to groundwater managers to define areas at risk from pollution and to develop groundwater management strategies. Groundwater vulnerability is defined as 'the tendency or likelihood for contaminants to reach a specified position in the groundwater system after introduction at some location above the uppermost aquifer' (National Research Council 1993). A vulnerability map is a graphical display or representation of the degree of vulnerability of an aquifer as a function of time and location. Geographic Information System (GIS) techniques are dynamic and represent various scenarios.

Methods

Soil hydraulic properties (size analysis, hydraulic conductivity, retentivity and organic content) were obtained from the results of 21 selected sites representing the major soil-types in the area under different management scenarios. Together with the

¹ CSIRO Land and Water, Private Bag No 5, PO Wembley, Western Australia 6913

regional soil maps, these were used to prepare the base maps for upscaling the modelling results.

Leaching potential of the pesticides were estimated using the results from applying several models: Hornsby Index (Hornsby 1992); AF Index (Rao and Alley 1993); CMLS (Nofziger et al. 1998); and LEACHP (Hutson and Wagenet 1992). Regional groundwater vulnerability maps that indicate the impact of leaching of pesticides under different management scenarios were prepared for the Gngangara Mound. Regional maps of pesticide leaching were also prepared using simple GIS techniques to upscale results from LEACHP modelling.

Soil and water mapping

A detailed soils map of the Gngangara Mound was collated from previous works by McArthur and Bettenay (1960) and McArthur and Bartle (1980). The physical and chemical characteristics of the soils were obtained from a detailed study of 21 sites in the Gngangara Mound. The sorption coefficients for the modelled pesticides with the different soils were derived in CSIRO Land and Water laboratories in Adelaide. A hydrogeomorphic map for distribution of recharge based on soils, geology, and attributes of topography was prepared from a digital elevation model prepared by the WALands Department.

A water-level map for the superficial aquifer of the Gngangara Mound was prepared using data obtained from the WAWaters and Rivers Commission SWRIS database. A depth-to-water map was prepared by subtracting the coverage of the surface elevation from the water-level map. The direction of groundwater flow was determined from the water-level map.

Herbicides in pine plantations

Establishment of pine plantations in the Gngangara Mound depends upon the use of herbicides such as triazines and glyphosate. The herbicides are applied once or twice per rotation at the rate of 0.5 kg/ha.

Transport of three herbicides (atrazine, simazine, and glyphosate) through the sandy soils to groundwater under the Gngangara Mound has been studied by Gerritse, Beltran and Hernandez (1996). Simazine, atrazine and degradation products of atrazine were moderately-to-strongly adsorbed to surface soils, with sorption coefficients >5 L/kg. Adsorption increased with increasing content of soil organic carbon, while adsorption in the subsoils was weak. Adsorption of glyphosate appeared to increase exponentially with oxides of iron and aluminium, and to decrease with increasing soil organic carbon. Glyphosate is also strongly adsorbed to the clay mineral kaolinite, which explained the strong adsorption measured in some of the sandy soils of the Gngangara Mound.

Pesticides in horticultural areas

In a field study of leaching and degradation of nine pesticides in the Karrakatta sand, Kookana, Di and Aylmore (1995) found that chlorpyrifos and chlorthal dimethyl are degraded to insignificant concentrations before reaching groundwater. In contrast, metalaxyl, linuron, and fenamiphos and its metabolites have much greater leaching potential. Due to much lower microbial population in the lower vadose zone, these pesticides may persist longer than expected and may present a contamination hazard to groundwater.

It was also found that behaviour of some of the degradation and transformation products of fenamiphos, which are toxic, differ markedly between subsurface and surface soils (Kookana, Phang and Aylmore 1997). Therefore, the degradation half-lives of pesticides based on surface soils (from current data bases) are unlikely to yield an adequate assessment of their environmental fate, especially movement through the soil profile to groundwater.

In urban areas around Perth, Gerritse, Barber and Adeney (1988) sampled 64 boreholes along a transect through the Bassendean sands and analysed these for aldrin, dieldrin, chlordane, and heptachlor. Generally the levels of the pesticides were found to be below detection limit; however, DDT, aldrin and chlordane were slightly higher in some samples. Most of the reported cases of pesticide contamination resulted from malpractices. For example, Appleyard (1995) reported that spray equipment washed in a backyard in suburban Perth resulted in contamination of groundwater with the nematicide fenamiphos and the herbicide atrazine.

Pesticide extraction

At the laboratory, core samples were cut into three equal lengths of 100 mm. The soil from each length was placed on a 30 x 30 cm alloy sheet and mixed thoroughly.

A soil sub-sample of about seven grams was sampled from each of the three mixed soil depths (0–100, 100–200 and 200–300 mm), and the soil placed into pre-weighed, labelled 16 x 125 mm pyrex vials with teflon lids. Care was taken to handle each soil sample using separate scoops made of aluminium to transfer the soil into the vials. Sub-samples for moisture content were also taken at the same time. The vials were then weighed, capped and recorded, as were the pre-weighed soil moisture content containers and soil.

Internal standard (25 ml) was then added to each of the vials, immediately followed by acetone/ether mixture (5 ml). A blank of the solvents was also taken

at this point. The vials were shaken vigorously for two minutes to mix the soil with the standard and the acetone/ether solution. The vials were placed into a sonic bath for ten minutes and left to stand for about 15 hours. The vials were sub-sampled using pasteur-pipettes to transfer 1 ml of the solution into 2 ml auto-analyser vials. The labelled vials were capped and placed into a freezer, ready for pesticide analysis.

Results

Pesticide analyses of soil samples collected from the strawberry and turf farms on separate days from three different depths for various pesticides are shown in Table 1.

Leaching of pesticides using CMLS and MS-VULPESTmodels

CMLS was used to simulate travel time for atrazine to a depth of one metre. The results show that due to the high hydraulic conductivity of the Bassendean sands, the travel time is about 59 days; but it takes approximately 173 days in some areas due to the high organic carbon. In the Spearwood Sands the travel time was about 77–100 days.

Soil maps of the Gngara Mound were used together with the MS-VULPEST model (Zhou and Otto 1999) to study the vulnerability of the most commonly used pesticides on a regional scale using the attenuation factor index (AF). The AF index is

Table 1. Pesticide analyses in the strawberry and turf farms.

Depth of Sample (cm)	Pesticide ($\mu\text{g}/\text{kg}$)						
	Atrazine	Diazinon	Dimethoate	Endosulfan	Chlorpyrifos	Fenamiphos	Malathion
<i>Strawberry farm (18/09/97)</i>							
0–10	<1	<5	<10	<10	<5	<5	<5
10–20	<1	<5	<10	<10	<5	<5	<5
20–30	<1	<5	<10	<10	<5	<5	<5
<i>Turf farm (14/10/97)</i>							
0–10	<1	<5	<10	<10	<5	<5	<5
10–20	<1	<5	<10	<10	<5	<5	<5
20–30	<1	<5	<10	<10	<5	<5	<5

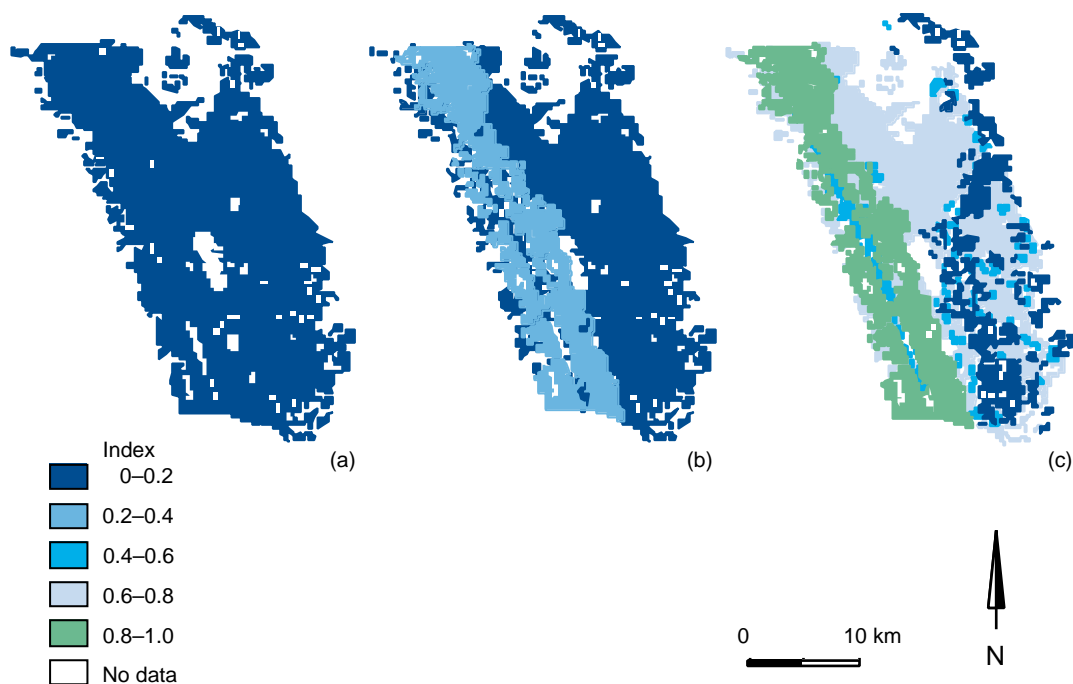

Figure 1. AF index of carbofuran to a depth of 100 cm and recharge rates of: (a) 0.1; (b) 0.3; (c) 0.6 cm/day.

equivalent to the fraction of the applied pesticide mass that is likely to leach past the chosen reference depth. The results are shown in Figure 1 and illustrate the regional risk of a pesticide (carbofuran, in this case) for the soils of the Gngangara Mound under three different recharge rates: 0.1, 0.3 and 0.6 cm/day.

Although the higher recharge rate indicates a higher AF index, the results also indicate that the soils have high filtering capacity and there is very small risk that high amounts of pesticide will leach below one metre. This is mainly due to the relatively high organic carbon content (1–4 per cent) in the top 15 cm of most soils in the area. The maps show the effect that different soils have on the AF index. The soils that are most vulnerable are the Karrakatta Yellow and Spearwood (Spearwood Dune System), and the least vulnerable are the Gavin and Joel (Bassendean Dune System). The AF indices for the other pesticides show that some, such as metalaxyl, gave slightly lower AF values than carbofuran; others, such as atrazine and metribuzin, were significantly lower.

Leaching of pesticides using LEACHPand GIS techniques

The LEACHP model was used to simulate the leaching of atrazine in the pine areas as well as in the horticulture areas. Modelling was carried out for the Bassendean as well as for the Spearwood sands.

Several simulations were carried out to ascertain the effect of the different management scenarios on the leaching of the pesticides.

Scenario 1:

irrigation water applied at the recommended rate of 100 per cent of pan evaporation

Scenario 2:

irrigation applied by the farmers (11 mm/day)

Scenario 3:

irrigation water with double the organic carbon of Scenario 1

Scenario 4:

irrigation water with double the organic carbon of Scenario 2.

The amount of pesticide applied in all four scenarios was 100 mg/m². The results (Figure 2) showed that applying Scenario 1 with the optimum irrigation rates will increase the travel time of the pesticide and will retain a higher proportion of the pesticide in the top layer, thus giving it more chance to degrade. The results also showed that Ky soils have a higher filtration capacity to all the modelled pesticides followed by the KIs while the Sp has the lowest filtration capacity. In the pines, atrazine leaching past the 80 cm layer was less than 10 mg/m² in all four scenarios as no irrigation was applied to the pines.

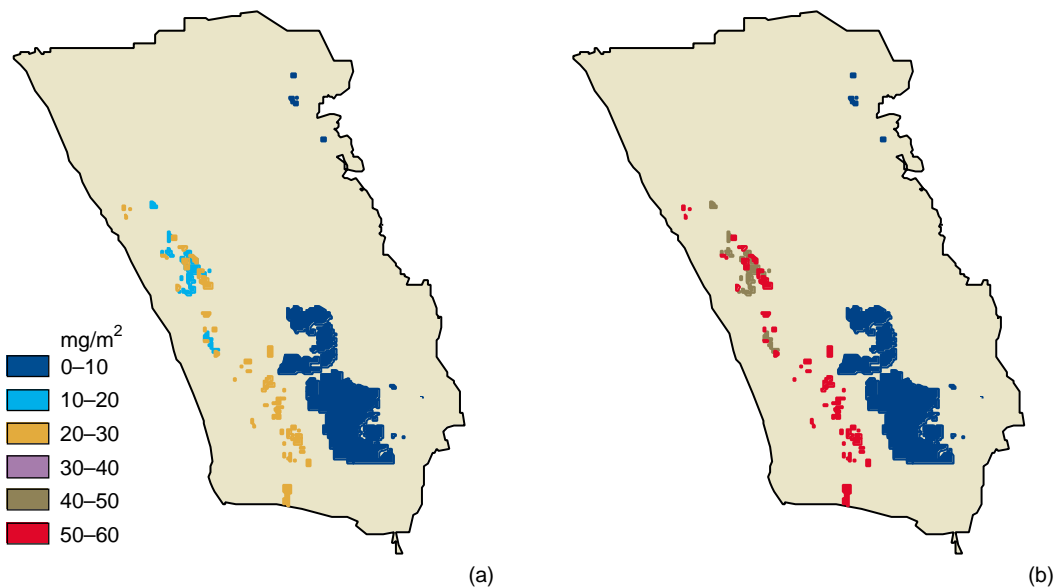

Figures 2(a–d). Atrazine leaching below 80 cm for LEACHP Scenarios 1–4, respectively.

In the horticulture areas on the Spearwood sands, in Scenario 1, more leaching of pesticides took place due to the application of irrigation water, mostly 30–40 mg/m². In some areas in the Ky soils, the leaching was lower and ranged between 10 and 20 mg/m² (Figure 2(a)). In Scenario 2, where higher irrigation rates were used, leaching was 60–70 mg/m² with the Ky showing slightly lower values of 50–60 mg/m² (Figure 2(b)). Adding organic carbon reduced the flux in the horticultural areas to below 20 mg/m² in Scenario 3 (Figure 2(c)), but even with double organic carbon, if the irrigation rate is increased to 11 mm, the higher rates of water infiltration will reduce the filtering capacity of the soils and more leaching will take place (Figure 2(d)).

Conclusions

The results of this study showed that only a small number of pesticides have the potential to contaminate the Gngangara Mound aquifer. This conforms with the conclusions of Salama, Pollock and Byrne (2001). The results also indicate that the most effective management to reduce nutrients leaching is by reducing fertiliser application rates and applying the optimum irrigation rates. The Karrakatta limestone sand appears to be the best soil to retain most of the nutrients.

Often managers and farmers do not have many choices for the selection of the most useful pesticide that will also have the shortest half-life and highest sorption coefficient. They will in some cases be influenced by trade names, advertising and prices. In most cases, in order to guarantee protection of their crop, they will use more than one pesticide that might have the same effect. It seems that the long-term solution to the pollution problem is the application of an integrated pest management practice. This includes using:

- minimum amounts of pesticides
- biological controls
- netting systems
- soil amendments to increase the organic carbon content
- better irrigation practices.

Nevertheless, due to the sandy nature of the Gngangara Mound soils and the fact that between 30 and 50 per cent of the irrigation water reaches the aquifer, the small number of pesticides that leach to the aquifer form a real threat to this vital water source.

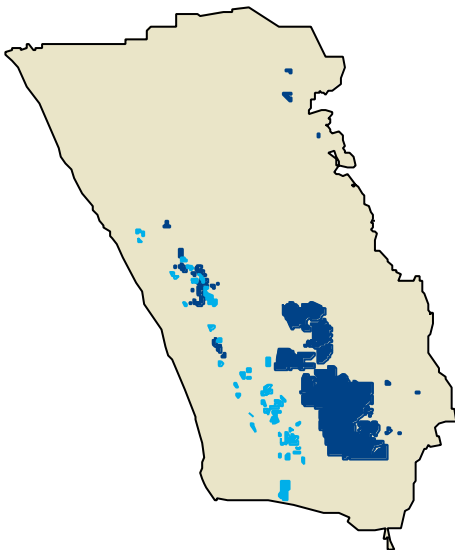

(c)

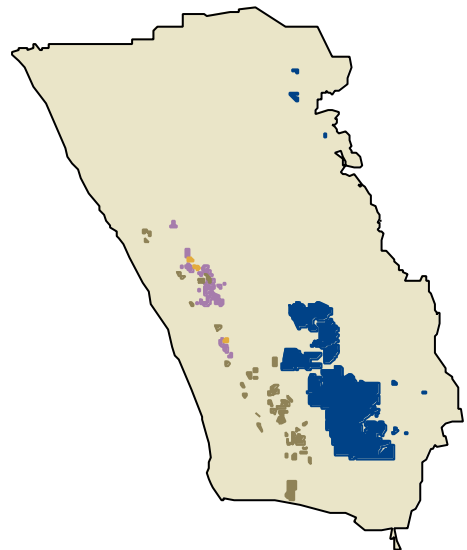

(d)

References

- Appleyard, S.J. 1995. Investigation of groundwater contamination by fenamiphos and atrazine in a residential area: source and distribution of contamination. *Groundwater Monitoring and Remediation* 15(4): 110–113.
- Gerritse, R.G., Barber, C. and Adeney, J. 1988. The effects of urbanisation on the quality of groundwater in Bassendean Sands, CSIRO Division of Water Resources Report, 52pp.
- Gerritse, R.G., Beltran, J. and Hernandez, F. 1996. Adsorption of atrazine, simazine, and glyphosate in soils of the Gngangara Mound, Western Australia. *Australian Journal of Soil Research*, 34: 599–607.
- Hornsby, A.G. 1992. Site-specific pesticide recommendations: the final step in environmental impact prevention. *Weed Technology* 6: 736–742.
- Hutson, J.L. and Wagenet, R.J. 1992. LEACHM: Leaching Estimation and Chemistry Model. Version 3. Cornell University, New York.
- Kookana, R.S., Di, H.J. and Aylmore, L.A.G. 1995. A field study of leaching and degradation of nine pesticides in a sandy soil. *Australian Journal of Soil Research* 33: 1019–1030.
- Kookana, R.S., Phang, C. and Aylmore, L.A.G. 1997. Transformation and degradation of fenamiphos nematocide and its metabolites in soils. *Australian Journal of Soil Research*, 35: 753–761.
- McArthur, W.M. and Bartle, G.A. 1980. Landforms and soils as an aid to urban planning in the Perth metropolitan Northwest Corridor, Western Australia. CSIRO Land Resources Management Series No. 5.
- McArthur, W.M. and Bettenay, E. 1960. The development and distribution of the soils of the Swan Coastal Plain, Western Australia. CSIRO Soil Publication No. 16.
- National Research Council 1993. Groundwater vulnerability assessment: Predicting relative contamination under conditions of uncertainty. Committee on Techniques for Assessing Groundwater Vulnerability, Water Science and Technology Board, Commission on Geosciences, Environment and Resources, US National Research Council.
- Nofziger, D.L., Chen, J.S., Wu, J., Ma, F. and Hornsby, A.G. 1998. The chemical movement in layered soils. Model for batch processing. Division of Agricultural Sciences and Natural Resources, Oklahoma State University.
- Rao, P.S.C. and Alley, W. M. 1993. Pesticides. *In*: Alley, W.M., ed., *Regional Groundwater Quality*. VNR, New York, 345–382.
- Salama, R.B., Hatton, T.J., Elder G.M., Ye, L. and Dowling, T. 1997. Hydrogeological characterisation of catchments using Hydrogeomorphic Analysis of Regional Spatial Data (HARSD): Characterisation of Axe Creek Catchment, Victoria, Australia. *In*: Taniguchi, M., ed., *Subsurface Hydrological Responses to Land Cover and Land Use Change*. Kluwer Academic Publishers, Boston: 153–166.
- Salama, R.B., Pollock, D.W. and Byrne, J.D. 2001. Modelling pesticide and nutrient transport in the Gngangara Mound. *These Proceedings*.
- Vighi, M. and Funari, E., eds., 1995. *Pesticide risk in groundwater*. CRC Lewis Publishers, London.
- Zhou, F. and Otto, C. 1999. MS-VULPEST User Manual. Multi-scale groundwater vulnerability assessment for pesticide contamination model. CSIRO Land and Water Report (in press).