



AgEcon SEARCH
RESEARCH IN AGRICULTURAL & APPLIED ECONOMICS

The World's Largest Open Access Agricultural & Applied Economics Digital Library

This document is discoverable and free to researchers across the globe due to the work of AgEcon Search.

Help ensure our sustainability.

Give to AgEcon Search

AgEcon Search

<http://ageconsearch.umn.edu>

aesearch@umn.edu

*Papers downloaded from **AgEcon Search** may be used for non-commercial purposes and personal study only. No other use, including posting to another Internet site, is permitted without permission from the copyright owner (not AgEcon Search), or as allowed under the provisions of Fair Use, U.S. Copyright Act, Title 17 U.S.C.*

The Australian Centre for International Agricultural Research (ACIAR) was established in June 1982 by an Act of the Australian Parliament. Its mandate is to help identify agricultural problems in developing countries and to commission collaborative research between Australian and developing country researchers in fields where Australia has a special research competence.

Where trade names are used this does not constitute endorsement of nor discrimination against any product by the Centre.

ACIAR PROCEEDINGS

This series of publications includes the full proceedings of research workshops or symposia organised or supported by ACIAR. Numbers in this series are distributed internationally to selected individuals and scientific institutions. Previous numbers in the series are listed on the inside back cover.

© Australian Centre for International Agricultural Research
G.P.O. Box 1571, Canberra, A.C.T. 2601

Champ, B.R., Highley, E. and Remenyi, J.V. 1987. Technological change in postharvest handling and transportation of grains in the humid tropics: proceedings of an international seminar, Bangkok, Thailand, 10-12 September 1986. ACIAR Proceedings No. 19, 208p.

ISBN 0 949511 29 3

Typeset and laid out by Press Etching (Qld) Pty. Ltd., Brisbane.
Printed in Australia by Brown Prior Anderson Pty Ltd Burwood Victoria

Technological Change in Postharvest Handling and Transportation of Grains in the Humid Tropics

**Proceedings of an international seminar
held at Bangkok, Thailand, 10–12 September 1986**

Editors: **B.R. Champ, E. Highley and J.V. Remenyi**

Sponsored by:

**Australian Centre for International Agricultural Research (ACIAR)
Department of Agriculture, Thailand
ASEAN Food Handling Bureau (AFHB)**

Contents

Address of welcome

Risikh Sayamananda
Deputy Director-General
Department of Agriculture 7

Outline of the objectives of the seminar

J.P. Mercader
Deputy Director, AFHB 9

Keynote address

Chaisop Sopsarn
Deputy Permanent Secretary of State
Ministry of Agriculture and Cooperatives 11

Executive Summary 13

Technical Aspects of Postharvest Handling and Storage 19

Collection of grain from the field

Loo Kau Fa 20

Grain drying strategies for the humid tropics

R.H. Driscoll 26

Grading, and maintaining grain quality in storage

J.H. Baird 35

Session chairman's summary

B.R. Champ 42

Economic Aspects of Postharvest Handling and Storage — Modelling 45

Overview of handling and transportation of grain

Won W. Koo 46

Optimisation techniques for the economic analysis of the postharvest handling and storage of grains
T.G. MacAulay 53

Applications of optimisation techniques for the grains postharvest sector in the humid tropics
G.J. Ryland 68

Session chairman's summary
R.K. Lindner 73

Economic Aspects of Postharvest Handling and Storage — Applied Studies 75

Opening remarks on current research methodology
C.W. McCormac 76

Issues determining the capitalisation of the rice processing industry in the Philippines
Zenaida F. Toquero 77

Returns from maintaining product quality in the Malaysian rice processing system
T.A. Chew and R.A. Ghaffar 92

Session chairman's summary
C.W. McCormac 97

Institutional Changes 99

Some views on the economic appraisal of technological change
J.J. Quilkey and P.J. Gunawardana 100

Marketing margins and grain quality: factors for institutional change
B. Duff 110

Relative effectiveness of private and public organisations in postharvest handling of grain
R.R. Pigott, E.M. Fleming, and V.E. Wright 118

The role of the public sector in postharvest technological change
Chrisman Silitonga 127

Session chairman's summary
J.V. Remenyi 141

Rates of Technological Change 143

Adoption and diffusion of technology: an overview

R.K. Lindner 144

Political and social constraints to rate of change in grain handling
technology in the humid tropics

Brian Fegan 152

The effects of regulation on the rate of adoption of technological change
in postharvest handling of grain

W. Horrigan 162

Session chairman's summary

Mohd Ghazali Mohayidin 167

Case Studies 169

The BULOG experience in storage management and quality maintenance

Mulyo Sidik 170

Application of grain dryers at farm level

Gloria D. Picar and Angelita G. Cardino 176

Evaluation of solar and husk-fired grain dryers

Sarun Wattanutchariya 183

Estimates of cost functions and costs of various paddy postharvest
handling activities in Malaysia

Mohd Ghazali Mohayidin 188

Chairman's summary

Ampol Senanarong 194

Concluding Session 197

Summary of seminar

J.V. Remenyi

Socioeconomics Research Program Coordinator, ACIAR 198

Closing remarks

A.W. Blewitt

Centre Secretary, ACIAR 202

Participants 204

Address of Welcome

ON BEHALF OF the joint organisers of this seminar, it is my pleasant duty to welcome all of you here today.

It is a special pleasure to welcome distinguished colleagues from many parts of the world. Beside participants from the ASEAN countries — Indonesia, Malaysia, the Philippines, Singapore, and Thailand — and Australia, we also have people from many countries outside the region, namely Bangladesh, Japan, Sri Lanka, Switzerland, the United Kingdom and the United States. I welcome all of you to Thailand.

As you may know, this seminar is made possible by the joint efforts of several organisations, including our own Department of Agriculture. International support has come from the Australian Centre for International Agricultural Research (ACIAR), and the ASEAN Food Handling Bureau (AFHB).

Thailand is one of the major rice growing countries of the world. About 10 million hectares are under the cultivation and annual production is 20 million tonnes. Rice is grown in all parts of the country, from the southern border with Malaysia to the northern border with Laos and Burma, a distance of about 1600 km. Most of the rice grown is of irrigated varieties dependent upon rainfall. There are few upland rice varieties. About 20% are floating rice varieties which may grow in water several metres deep.

Little rice is stored on-farm in Thailand. Most of the harvest goes into mills, warehouses, or silos ready to be released to the local markets, or exported. Here it may be affected by agents such as insects and moulds causing reduction in quality. The quality losses caused by these agents may be quite high.

Thailand is a major exporter of rice and is proud of the quality of its product, which is much sought after within and outside the region. We are therefore very interested in introducing cost-effective, non-disruptive technology that will minimise quality losses.

I am sure that our interest in this seminar will be shared by all countries in the region because, to some degree or other, most of the problems we have in handling and transporting grains are common to all of us and result from the difficult weather conditions encountered at the time we harvest the main crop of the year. By sharing our experiences and tapping the expertise of the international research and development community, we should be able to devise the solutions most appropriate to our particular needs.

I hope that this gathering of experts in the natural and social sciences will be able to provide the necessary framework for assessing which particular technologies of grain handling and transportation would be most appropriate for introduction into the region.

I hope that you have a successful seminar and an enjoyable stay in Thailand.

Rishk Sayamananda
Deputy Director-General
Department of Agriculture

Outline of the Objectives of the Seminar

It is a distinct honour for me, on behalf of the ASEAN Food Handling Project, to have been given this opportunity by the Australian Centre for International Agricultural Research to address this distinguished gathering of experts participating in the International Seminar on Technological Change in Postharvest Handling and Transportation of Grains in the Humid Tropics.

The wave of technological changes in grains postharvest technology now sweeping throughout the ASEAN region is unprecedented in its history. Probably in no other time has this region experienced such an upsurge of technological innovations in grains postharvest processes. Significant advances have been attained in grains harvesting, drying, handling, storage, and milling operations during the last decade. Within this period, the policies of the ASEAN governments have underscored the development of the postharvest sector to maximise the huge gains in the production of grains in the region. Against this backdrop, there is a need for professional commitment by scientific researchers and development workers in the grains postharvest sector to guarantee that the technological innovations evolved and applied are appropriate and beneficial.

It is necessary for researchers and implementors to pause awhile and review the present situation. How sound are these technologies currently available to the region's farmers and other users? What constitutes a 'sound' technology? How beneficial economically are or have been these technologies to their users and how acceptable have they been to their varying sociocultural environments? This seminar provides us with a valuable opportunity to take a long and searching look at these and related questions.

The first objective of this seminar is to review the technical and economic aspects of grain handling and transportation in the humid tropics. The nine papers to be presented in Sessions B, C, and D are sufficient to elucidate the key issues pertaining to the technical feasibility and economic viability of grains postharvest technologies. I am particularly delighted to note that economic analysis will be brought to bear upon the technical aspects of postharvest handling, storage, and transportation. Indeed, ACIAR in general and its Stored Grain Research Program in particular are to be congratulated for their quick recognition that other criteria will have to be taken into consideration when developing and applying grains technology. I note that the focus of this seminar will be the adaptation of such technologies in humid tropical conditions.

The second objective of this seminar reminds us of the need to develop a holistic view of the processes associated with technological change in developing countries. This objective underscores the need to identify social, economic, and physical processes that are important for evaluating the private and social benefits of changes in grains handling. Sessions E and F, on institutional changes and rates of technological change, introduce criteria, other than those techno-economic in nature, to be used in judging the appropriateness of technology. Institutional changes cover a wide field, touching upon the sociocultural milieu of the users and the mechanisms for the delivery of services and innovations. The case studies in Sessions D and G will illustrate how well technical, economic, and institutional factors have been incorporated into various experiments to introduce technology in various sociocultural settings.

The list of presenters and the participants at this seminar indicates that the discussions on technological change in postharvest handling and transportation of grains in the humid tropics will be illuminating. The mix of ASEAN and non-ASEAN

scientists, project leaders, and policy makers will ensure that the many dimensions in the process of technological change will be adequately covered. The vast experience gained by the Food Handling Project and ACIAR will be brought effectively to bear upon the topic of this seminar.

On behalf of Food Handling Project and the Grains Working Group of the Subcommittee of Food Handling, I must congratulate ACIAR and Dr Bruce Champ for initiating this seminar. We have had many cooperative activities in the past and we look forward to further fruitful collaboration in the future.

Let me close my remarks by wishing all delegates productive deliberations on the important issues implied in the theme of this international seminar. Just as grains postharvest technology needs to be appropriate and relevant to the humid tropics, our efforts as researchers and initiators need to be justified to the agencies which have funded our manifold activities in this area and to the people to whom our efforts are dedicated. Thank you.

J.P. Mercader
Deputy Director
ASEAN Food Handling Bureau

Keynote Address

ON BEHALF OF the Permanent Secretary of State, it is a great pleasure for me to be here on this important occasion and I am honoured to be asked to address the assembly and to declare open this seminar on Technological Change in Postharvest Handling and Transportation of Grains in the Humid Tropics.

On behalf of the Royal Thai Government, I extend our warmest welcome to all the distinguished guests, learned speakers, and interested observers. I hope that you will all enjoy your stay in our country.

This seminar has been organised by the Department of Agriculture in collaboration with two international agencies — the Australian Centre for International Agricultural Research (ACIAR) and the ASEAN Food Handling Bureau based in Kuala Lumpur. It is yet another good example of the cooperation between national and international research agencies in their joint efforts to find ways around the most important barriers which still hamper agricultural development in our region.

The safe handling and transportation of grain after harvest is one such barrier facing us at present. In the last 20 years or so, great improvements in the level of production of staple foodstuffs such as rice and maize in the region have been made. Not only have new, higher yielding varieties of staple crops been introduced, but also, by land development and irrigation systems, we have been able to expand our arable areas and thereby increase the volume of our yield. As a result, we have created for ourselves a new problem in handling the much larger harvest.

To solve storage and handling problems, there is a range of technologies from which to choose, or which might be adapted to particular situations. It is most gratifying therefore to know that we have available the combined expertise of specialists who come together in collaborative projects and at meetings such as this to share their practical knowledge with the common intention to overcome existing constraints.

It is probably true to say that there is no such thing as a technical solution to a particular storage problem. Rather, there is a best solution that must be developed from a detailed consideration of the resources available and the socioeconomic environment in which they are to operate. The storage technology introduced must be appropriate to the needs of users at all steps of the process from harvest to consumption, if the chances of adoption are to be enhanced and success ensured. Moreover, a great deal of extension effort may be needed to convince potential users of its value before the technology can be transferred into routine use. Indeed, technological change is quite a problem in itself.

Collaborative research projects in our region, sponsored by ACIAR and a number of other national and international agencies, are beginning to develop a new range of technologies applicable to the problems of storing grain in the humid tropics.

Research studies in the region have already shown that there is a pressing need to reduce the losses to grain that occur immediately after harvest, by introducing appropriate drying technologies. Most agencies readily acknowledge this. Why then has the rate of adoption of the mechanical drying strategies that can solve the problem been so low?

This seminar has been organised in the knowledge that the answer to this and many other questions relating to postharvest handling and transportation of grains lies just as much in social and economic issues as in technical matters. The organisers have therefore brought together not only storage specialists but also experts in areas such as economic modelling, systems analysis, anthropology, technology transfer, and labour matters. In addition, a series of case study papers will be presented by people

with an intimate knowledge of the storage systems in their own countries. We look forward to hearing of their experiences, mindful of the fact that social scientists and their more technical colleagues do not always see eye to eye. For this reason, I feel that we can all expect to hear a great deal of stimulating and thought-provoking discussion at this seminar.

Distinguished participants, other important functions of seminars such as this are to check that current research remains on target and to identify priorities for future work. These functions become all the more important in times when resources for research are becoming scarcer due to general economic circumstances. Also, the identification of future priorities in the postharvest field is particularly important and opportune as in some areas we are moving from research to the development and application phase. The types of activities associated with extension and technology transfer are quite different from and inherently more resource-intensive than research activities. It is essential, therefore, that both the farmers and their environment be taken into consideration in the extension and transfer process.

I understand that throughout the seminar, we shall be hearing some 19 papers presented by specialists from seven different countries. They will cover technical matters, economic modelling and applied economics, institutional changes, rates of technological change, and, as mentioned earlier, some country case studies. There will be time at the end of each of the six working sessions for discussions. I sincerely hope that there will be lively participation in these discussion sessions, which are designed not only to clarify points arising from particular presentations, but also to stimulate the interchange of ideas which is perhaps the most important function of gatherings such as this, both in and out of the formal sessions.

Summaries of the discussions will appear in the proceedings of the seminar, which I understand will be published by ACIAR, probably during the early part of the next year. They will thereby continue for some time to be a useful source of information for all of us.

I therefore wish to place on record here our sincere appreciation for the kind cooperation extended to us by both the Australian Centre for International Agricultural Research (ACIAR) and the ASEAN Food Handling Bureau whose valuable assistance has made this seminar possible.

I wish you all every success in your deliberations and a happy sojourn in Thailand. Thank you.

Chaisop Sopsarn

Deputy Permanent Secretary of State
Ministry of Agriculture and Cooperatives

Executive Summary

THIS was the third of the international postharvest seminars with which the ACIAR Grain Storage Research Program has been associated.

The seminar provided a forum for technologists, economists, and sociologists to debate issues relating to the introduction of new technology into the grains postharvest sector. The objectives were to review technical and economic aspects of grain transportation in the humid tropics and to identify social, economic, and physical processes that are important for evaluating the private and social benefits of changes in technology of grain-handling equipment and operating procedures.

Total registrations for the seminar exceeded 150, representing ASEAN and eight other countries. During the three days of the seminar, participants heard and discussed 19 papers in seven sessions.

The first session covered technical aspects. The three papers presented highlighted the major problem areas in the postharvest grains sector and identified some of the technology offering potential solutions to these problems. Mr Loo Kau Fa of LPN, Malaysia, dealt with collection of grain from the field, Dr Robert Driscoll of the University of New South Wales, Australia, with grain drying strategies, and Mr Hugh Baird, a rice consultant from Australia, with problems of grain grading and maintenance of its quality in storage.

The speakers clearly identified real problems in the Southeast Asian region, particularly those relating to the wet season harvest. For example, Mr Loo Kau Fa identified the technical constraints to safe caretaking of the grain in the vital period between harvest and delivery to some form of storage. The serious bottleneck that occurs in the wet season results in very marked deterioration of grain and it was evident from subsequent discussion that this problem can be exacerbated by procurement and pricing policies that provide no incentives to farmers to overcome it.

Mr Loo suggested that, for countries like Malaysia where labour costs are high, conversion to an efficient bulk-handling system would minimise losses, both quantitative and qualitative, at the lowest cost to growers. Irrespective of this, it was clear from the various comments made by participants that there will continue to be serious losses until efficient procurement policies and incentives are put into place. This was to become one of the main themes of the seminar.

The next two sessions were devoted to economics. The first considered the role of economic modelling in conceptualising the grains postharvest sector, identifying the main problem areas, and as a tool for predicting the impacts of particular technologies or policies. Professor Won W. Koo from the University of North Dakota, USA gave a broad overview of the handling and transportation of grain, and Australians Dr Gordon MacAulay of the University of New England and Dr George Ryland, an economic consultant, in two separate papers, looked at various aspects of the use of optimisation techniques for the economic analysis of the postharvest handling and storage of grains.

In his paper, Professor Koo revealed the dimensions of the coordination problem in the system of postharvest grain handling, and of the potential benefits to society that would be realised by solving this problem effectively and efficiently. He also explained very clearly the economic principles underlying the problem of modal price in the transportation subsystem and of how the interaction between upgrading and assembly costs can influence the best method of handling and storing grain. Finally, he showed how economic models can be used to investigate the efficiency of alternative grain-handling systems, such as bulk-handling versus the more traditional

system of bagging the grain before it is transported, and he drew a useful distinction between intraregional and interregional models.

One of the issues raised during discussion of the three papers in this first economic session was that of government intervention in the marketing system and how this might affect the validity of the models put forward. Approaching this issue in a slightly different way raises the question as to what such models can tell us about the relative merits of leaving postharvest handling and transportation of grains to private enterprise. If, as was argued by several speakers, a competitive market can solve the coordination problem in grain transportation, then there is no apparent value from modelling exercises in countries where the free market prevails. Not surprisingly, not all participants shared this view, and argued that government intervention is needed to ensure efficient coordination. More importantly, government involvement in grain handling is a fact of life in many countries, and one way in which transportation models can be used is to highlight the efficiency gains or losses associated with such intervention. In other words, the models can be used to assess particular policies.

The second session on economic matters dealt with various applied studies. Papers were presented by Dr Zenaida Toquero from SEARCA in the Philippines, Dr Tek Ann Chew and Dr Roslan Ghaffar of Universiti Pertanian Malaysia, and, in absentia, by Dr John Quilkey of La Trobe University in Australia.

Dr Toquero's paper dealt with issues determining the capitalisation of the rice-processing industry. She examined the different variables influencing the development of the grains postharvest sector in the Philippines. These can be grouped as economic, sociocultural, technological, and those related to government policies and programs.

The sociocultural traits prominent in Filipinos significantly influence the production and postproduction system. They are evident in labour arrangements for weeding and harvesting, extension of credit facilities, and in the marketing of produce. Because they provide a guaranteed market for the farmers' output and guaranteed repayment of debts to creditors, sociocultural circumstances and associated market arrangements benefit both traders and farmers.

Dr Toquero also noted that certain technical issues, such as facility design, location, management, and supply of good quality paddy had not been critically examined and considered with reference to location-specific conditions when these facilities were being planned for introduction. Government policies and programs regarding the procurement of grains introduced constraints and/or inappropriate changes in the marketing system. This was a view echoed by several other speakers.

During the general discussion of this and the two other papers presented during this session, much attention was given to three questions: how do we identify the sectors of society that benefit from postharvest technological changes; how do we quantify the benefits; are there benefits other than economic ones that need to be defined and measured? An important clarification to emerge from the discussion was that there are social and political components to economic benefits, not just monetary gains.

The fourth working session of the seminar dealt with the bearing of institutional factors on technological change in the postharvest sector. Papers were presented by Dr Bart Duff from the International Rice Research Institute (IRRI) in the Philippines, Dr Roley Piggott from the University of New England in Australia, and Mr Chrisman Silitonga of BULOG, Indonesia.

The three papers and the discussion following their presentation highlighted that institutional innovation and adaptation will be essential as the impact of changes in a number of critical factors in the grains postharvest sector gathers momentum. Three of these factors are:

- *the increased importance of the wet season crop in total output;
- *the shift to increased commercialisation in cereal markets in tropical countries, reflected by a higher proportion and quantity of output entering the marketing chain;

*growth in sophistication and capacity to discriminate between qualities of grains as incomes and food security increase in tropical countries.

However, session chairman Dr Joe Remenyi of ACIAR cautioned that institutional changes should be well considered before they are implemented. In the past there has been a tendency to create waste through excessive haste by setting up parastatal institutions the need for which was not satisfactorily validated beforehand and which have not contributed to increased efficiency. The power of the invisible hand of the free enterprise system to address and produce appropriate solutions to postharvest problems should not be underestimated. Neither should the problems associated with government intervention.

While market failures in the postharvest chain can be identified, to overcome them does not always imply a parastatal or similar public intervention. Governments can facilitate group action or the relaxation of the constraints that give rise to market failure by ensuring that the necessary infrastructure is put in place and that policies in force result in the correct set of incentives to farmers, processors, transporters, and other participants in the postharvest sector.

Among the conclusions that could be drawn from this session were the following:

- *there needs to be much more policy work in the food sector;
- *there is a need to isolate where inefficiencies arise and design solutions to overcome them;
- *lateral thinking is needed in order to ensure that the appropriate discipline is brought to bear on problems identified;
- *the costs of inappropriate policies and institutional responses need to be identified in order to emphasise the case for reform.

The fifth session of the seminar dealt with the factors influencing rates of technological change. Professor Bob Lindner of the University of Western Australia gave an overview of the process of adoption and diffusion of technology. Dr Brian Fegan of Macquarie University in Australia, discoursed on the powerful influence of political forces on technological change. Mr Bill Horrigan of the Australian Department of Primary Industry, using the Australian export wheat industry as an example, showed how government regulation to meet the requirements of international markets can determine the direction and rate of technological change in grain handling.

Dr Fegan's paper introduced the element of politics into the business of the seminar in a forthright way, and stimulated a great deal of useful discussion. From an examination of the level of technology adoption in the Philippines, he concluded that the main reasons for government intervention in the grain-handling system are political and that this is a major constraint to full utilisation of new technology. Instead, government policy, aimed at procuring farmers' votes, involves the state in large capital costs and subsidies, and results in large quantitative and qualitative losses in grain.

As had been done in a number of earlier presentations in the seminar, Dr Fegan stressed that market orientated farmers, traders, storers, transporters, and millers will use new technology only if the benefits derived from its adoption exceed the costs. He used grain dryers as an example. Low annual throughputs and organisational problems place the capital costs of dryers beyond the reach of small farmers. They are more likely to be adopted by traders with sufficient capital to buy grain from a wider area, particularly those with integrated storage and milling facilities. In a similar vein, bulk handling is probably appropriate to only isolated areas producing surpluses on large farms, with a monopoly grain buyer, and a distant urban or overseas market.

Among his conclusions, Dr Fegan noted that to be able to predict demand for technology and thereby enable design for demand rather than vague 'national need' we need to know what are the perceived grain saving problems of the various operators in the private sector.

The lively discussion that followed presentation of the three papers in this session centred on a small number of major, interrelated issues. These included:

*While profitability is perhaps the most important factor determining technology adoption and the rate of technology diffusion, factors such as the presence of non-market inputs (e.g. family labour) are also influential.

*Extension services are important to successful technology adoption and diffusion. They should be consulted *before* the development of a possible new technology begins, as indeed should the potential users of the technology. The quality of extension services probably needs improving.

*While current levels of government intervention in the postharvest sector may be excessive, they need to be considered in the light of circumstances in particular countries.

The last four papers of the seminar were case studies on the introduction of particular technologies into the storage systems of four countries in the region.

Dr Mulyo Sidik recounted BULOG's experience in Indonesia following the introduction of comprehensive storage management and quality maintenance procedures. Carbon dioxide fumigation and vacuum packaging technologies involved were outlined. The program has been successful in reducing losses in BULOG storages from 3-5% to an estimated 0.3% per year.

Ms Gloria Picar and Ms Angelita Cardino of NAPHIRE in the Philippines reported an investigation of the reasons for the low level of adoption of grain drying technology at the farm level in their country. They found these to be mainly socioeconomic, involving factors such as high fuel costs, unsuitable dryer capacity, lack of capital to purchase or run, inadequate extension programs, a paddy pricing system that provides no incentive to dry, and an inadequate paddy grading system.

Dr Sarun Wattanutchariya of Kasetsart University, Thailand reported a study comparing the costs of and returns from traditional sun drying, a solar dryer, and a husk-fired mechanical dryer in three areas of Thailand. He concluded that both sun and solar drying were impractical because of inclement weather. While the husk-fired dryer is effective, its capital cost is too high for small farmers. In any case, because of the low paddy prices, there would have been little or no economic incentive to farmers to dry their paddy during the period the study was conducted.

The final paper of the seminar was presented by Dr Mohd Ghazali Mohayidin of Universiti Pertanian Malaysia. He reported on cost estimates of individual components of the Malaysian rice postharvest industry obtained from data collected during the 1984-85 harvesting season. The aim of the work was to develop cost functions for incorporation into an economic model of the Malaysian rice industry. The study showed that drying and milling were by far the largest components, between them accounting for over 70% of total postharvest costs. The study also showed that the Malaysian rice processing industry is not profitable. The costs of producing a tonne of milled rice are significantly greater than the price received for it.

It was the objective of the final session of the seminar to attempt to draw together the multifarious issues that had arisen during the previous three days into some overall conception of where we stand as regards technological change in the grain handling industry and in what directions we might best move. As it turned out, given the pertinence of the excellent papers presented and the high degree of participation in discussion, this was not so forbidding a task as might have appeared on the first day of the seminar.

The session opened with the presentation of summaries of the previous working sessions by each chairperson. The summaries are printed in this volume after the papers presented in each session. Considerable discussion ensued, leading to presentation for further discussion of a set of possible goals for future research in the postharvest sector. These were:

*To protect gains made in production by reducing losses after harvest.

*To assist in structural adjustment to an environment of increasing levels of marketed surplus in tropical countries.

*To encourage the creation and adoption of appropriate technologies that meet the needs of both producers and consumers, and do this by objectively identifying where in the postharvest chain interventions can usefully and effectively be made.

***To identify primary constraints to more effective and efficient operations in the postharvest system. Whether it is the flow of innovation or the policy environment that is blocking progress was the critical underlying question.**

There was no criticism of these objectives. Most importantly, as regards the last of them, there appeared to be a consensus that resources and priorities need to be reallocated from the technical to the policy areas. There also needs to be a reallocation of resources from food production to postharvest analysis: there is clearly little point in introducing increasing amounts of staple foods into a postharvest system that cannot cope with the present production pattern. Another issue raised was the allocation of most current funding to government institutions and public agencies. The potential utility of involving the private sector should be assessed.

The seminar thus ended with the clear conviction that postharvest workers should now be directing more of their energies to changing policies that are inimical to good postharvest practices. As a first step towards achieving this formidable goal, postharvest R & D workers must begin to involve the policy makers in all their deliberations. In addition, in considering the objectives of their research and the implications of its results, they must begin to give more serious thought to the very useful economic concepts of benefit/cost and 'net social welfare'.

Technical Aspects of Postharvest Handling and Storage

Collection of Grain from the Field

Loo Kau Fa *

Abstract

It is evident that considerable technological changes have been successfully introduced at both grain production and processing levels in several Southeast Asian countries. However, there is still a serious bottleneck in the handling and transportation of grain between the field and procurement centres. These remain very much as traditional procedures. The current practice, which involves bagging the grain before it is transported, is cumbersome, time consuming, and uneconomic. Its shortcomings have been exacerbated by the widespread introduction of mechanised harvesting.

It is suggested in this paper that conversion to bulk handling of grain is a feasible solution to the problems encountered. Technological changes that are needed to effect such a conversion, and their constraints, are discussed. The fundamental appeal of the concept lies in its potential to provide grain handling at the lowest cost to the growers. For the grain industry as a whole, an efficient bulk handling system will contribute to a reduction in postharvest losses, by eliminating or minimising the spillage and quality deterioration associated with bag handling.

IN humid Southeast Asia, paddy is traditionally cultivated once a year in rainfed, flooded fields. However, with the provision of proper irrigation and drainage facilities and the adoption of short-maturing varieties of paddy, double-cropping is now possible. As a result, the handling of wet paddy can be a major problem, especially for the off-season crop, which is harvested during the wet season. This is due to the fact that wet paddy of modern varieties exhibits lower seed dormancy and undergoes rapid deterioration in quality (Mendoza and Quitco 1984). With the implementation of double-cropping, farmers are faced with the problem of harvesting the first crop and planting the second crop within the same period of six to eight weeks, if the traditional, labour-intensive method of handling is followed.

This paper examines the various stages of current postharvest practice in the region, from harvesting and threshing, to in-field collection of grain and transportation to the procurement centres. It also discusses the advantages and disadvantages of the components of different systems, and makes some suggestions on how improvements may be affected.

* Division of Engineering, National Paddy and Rice Authority (LPN), P.O. Box 10108, 50903 Kuala Lumpur, Malaysia.

Harvesting Practices

Traditionally, harvesting is done manually with the sickle as the most commonly used tool. Before the actual harvest, the farmer selects and gathers the best paddy for seed, using a sharp hand blade, the 'tuai'. The main crop is cut by sickle and tied into small bundles. A 'shield' is placed around three sides of the threshing tub to prevent the scattering of grain. Threshing is hard work as much force has to be used while beating the sheaves of paddy on the 'ladder' placed inside the threshing tub, which is a wooden box. For historic reasons, gangs of women usually cut the crop and it is left on the ground for gangs of men to later collect and thresh. In Malaysia, many farmers report labour shortages at harvest and this has led to the two operations of cutting and threshing being separated for as long as 4 hours. As most of the wet season harvests take place in wet fields, the act of putting the cut crop onto the stubble causes an uptake of moisture of almost 6% by the time the crop is threshed (Calverley et al. 1976).

The relatively high cost of manual harvesting has acted as an incentive to local agricultural equipment distributors to introduce small, powered reaper-binders, power threshers, etc. in countries such as the Philippines, Indonesia, and Thailand. However,

these have not been accepted to any degree in Malaysia. The problem appears to be related to the low-productivity of these forms of mechanisation, the fact that no great reduction in labour requirements is effected and, in some cases, to their unsuitability to physical conditions in the major Malaysian rice areas. Power threshers, for instance, save some physical effort in threshing, but a considerable amount of labour is still required for reaping and carrying of rice sheaves to the thresher.

Because of farm labour shortages and rising labour costs in Malaysia, harvesting has been considerably mechanised over the past few years (Embi 1986). For example, about 95% of the Muda Irrigation Area uses large, continental-type, self-propelled combine harvesters (Table 1). There are about 330 combine harvesters in the Muda area, about 90% of them owned by contractors providing a service to farmers.

Under wet field conditions, the work rate of a large combine averages 0.35 ha/hour. They operate twice as fast under dry conditions. This includes reaping, threshing, grain/straw separation, and loading threshed grain into a grain tank mounted on the combine itself. Small plot size, though lowering productivity, is not found to be a serious problem. Khairuddin (1986) has reported that it now costs about US\$85 to harvest one hectare of paddy using a combine in the Muda Irrigation Area, and twice as much if manual labour is used.

The apparent benefit of mechanisation is very significant for harvesting, but not so for crop establishment, where labour usage can only be reduced substantially when direct seeding is

practiced (Table 2). From a requirement of more than 600 personhours/ha, it has now reduced to about 255 for transplanted crop and 129 when direct seeded. However, this is only possible when parallel development is emphasised, as can be seen by the tremendous increase in such expenditure that has occurred (Fig. 1). Complaints as to grain quality from combines, particularly the high incidence of immature grains and impurities, as well as grain breakage and partial dehusking, are reported by Rohani et al. (1984). Comparison of combine-harvested and hand-harvested samples (Table 3) showed, among other things, an increase of 4.5% in broken in the combine-harvested samples.

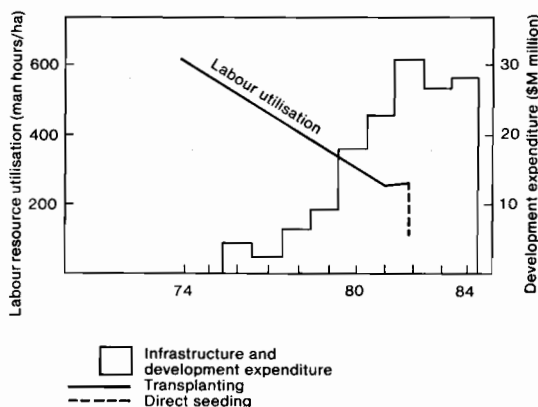

Fig. 1. Developmental expenditure and labour resource utilisation, Muda Irrigation Area, West Malaysia. (Source: Muda Agricultural Development Agency, personal communication, 1985.)

TABLE 1. Cost and level of mechanisation in rice farming in Malaysia.

	MADA ¹	KADA ²	Barat Laut ³
Transplanting cost*/ha (excluding nursery)	1971- 44		
	1976-112		
	1979-143	1979-145	1981-148
	1981-199	1982-190	1983-183
Tillage by tractors (%)	1966- 32		1966- 11.8
	1969- 94	1975-n.a.	1976- 99
	1975- 99	1980- 99	1980- 99
	1984- 99	1981- 99	1983- 99
Manual harvesting cost/ha (cutting & threshing)	1966-n.a.	1966-n.a.	
	1976-193	1977-178	1981-309
	1979-312	1980-304	1983-338
Combine harvesting (%)	1975-n.a.	1980- 1	1975-n.a.
	1980- 93	1983- 3	1981- 60
	1984- 95		1985- 80

Sources: 1. Muda Agricultural Development Agency

2. Karang Agricultural Development Agency

3. Barat Laut rice-growing district, Selangor. Personal communications and unpublished reports

n.a. = not available

*Costs are in Malaysian dollars (M\$2.65 = US\$1)

TABLE 2. Labour utilisation in paddy production in the Muda Irrigation Project, Malaysia.

Type of activity	Transplanting technique 1974	Transplanting technique 1981	Direct-seeding technique 1983
	(personhours/ha)		
1. Seed preparation	3.3	3.4	2.2
2. Nursery preparation	26.3	20.1	0
3. Land preparation	50.4	14.7	8.9
4. Planting/direct sowing	151.7	132.9	33.9
5. Fertiliser & insecticide application	12.2	14.4	14.3
6. Weeding	49.6	10.0	12.4
7. Water management	1.5	25.0	25.9
8. Harvesting	254.8	12.2	24.3
9. Paddy transportation	28.1	17.1	5.0
10. Postharvest work	37.1	5.4	2.4
Total	615.0	255.2	129.3

Source: Muda Agricultural Development Agency (unpublished report, 1985)

TABLE 3. Qualitative comparison between combine-harvested and hand-harvested samples of paddy in Malaysia.

Quality measure (%)	Combine-harvested samples	Hand-harvested samples
Impurities	5.50	4.20
Injured grains	0.54	0
Cracked grains	1.60	0.60
Immature grains	7.40	5.50
Total milling yield	66.70	67.30
Head rice yield	87.60	92.10
Brokens	12.40	7.90

Source: Rohani et al. (1984)

However, it is debatable if these are due solely to the combines as such. It is believed that the existing paddy grading system and pricing policy needs to be reviewed.

The question of field and infrastructure damage is perhaps of greatest concern at present. Efforts to introduce small, light-weight, head feed type combines have not succeeded so far, due to their low rate of work and lack of durability under contractor conditions. Small combines have also been reported to be more expensive in relation to output (Ahmad 1986). Efforts are under way to identify more suitable machinery to replace the large combines.

In-field Handling

In the region, collection and transportation of paddy in jute or hessian sacks are still most widely practiced though, in some instances, plastic woven bags are also being used. The present system invariably entails bagging the grain for transport whether it is manually or machine harvested. Each

jute bag weighs about 80–90 kilograms when filled. Bagging is found to be cumbersome, time consuming, and uneconomical, and creates bottlenecks in the postharvest system, particularly in terms of sorting and grading of grain at receipt. Figure 2 illustrates the present options for collection of grain after harvesting. In the case of manual harvesting, threshed wet grain will be bagged in the middle of the field and transported to the road. In-

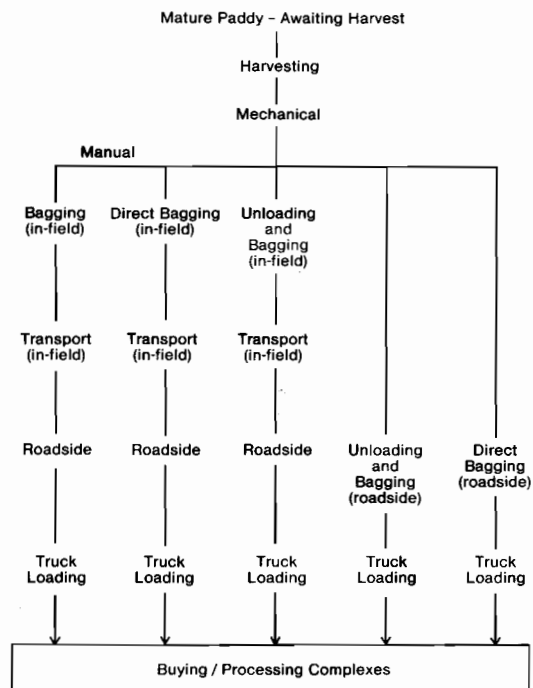

Fig. 2. Diagram showing pathways in the existing system for postharvest handling of paddy in Malaysia.

field transport can be accomplished in a number of ways, most commonly by bicycle, motorcycle, and buffalo sledge.

To load the bicycle or motorcycle, the jute sacks are carried from the field by men, often through mud and water, to the narrow bund where the bicycle or motorcycle is propped up on its stand. The bicycle usually has a load of one sack, whereas one to three sacks of paddy may be carried by a motorcycle, depending on the bund's condition. The bunds are generally not more than 300 mm wide and it is along these that much of the crop must be carried. Obviously, it is a difficult and arduous operation to transport paddy from the field to a laterite or metalled road, along which it can be carried by lorry and delivered to the procurement centre. A survey by the Tropical Product Institute (TPI; now known as the Tropical Development and Research Institute, TDR) in 1976 (Calverley et al. 1976) indicated that 64% of the parcels of land were within five relongs or 250 m of a laterite or metalled road. In some of the larger blocks, the distance was as much as 25 relongs or 1250 m but this was exceptional (Table 4).

Apart from distances, the limited number of access bridges across irrigation waterways and drains imposes additional constraints on accessibility. Figure 3 shows a schematic representation of a typical irrigation block in the Muda Irrigation Area. The total paddy area within such a block varies between 400–600 ha, accommodating 250–400 farmers. Examining the existing road system, the lack of in-field vehicular access is quite apparent, especially considering the size of paddy land involved. Few farmers have direct access to roads, their location relative to the road system being a matter of chance. To some extent, new farm roads may be constructed as part of the long-term program to improve physical infrastructure at the farm level which also incorporates the establishment of tertiary irrigation and drainage facilities. However, bearing in mind that a reasonable balance has to be struck between the intensity of the roads in the agricultural area and the need to conserve as much land as possible for food production, it is unlikely that future road development alone will have any significant impact on the basic character of the in-field transport problem.

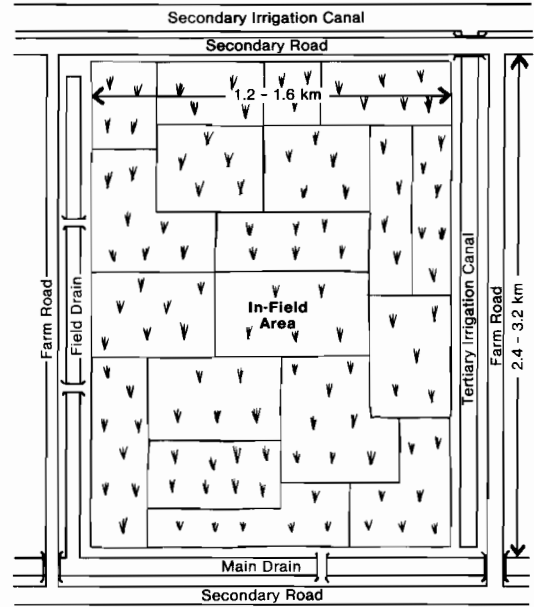

Fig. 3. Schematic representation of an irrigation unit in the Muda Irrigation Area, West Malaysia.

As harvesting is mechanised, where the field is close to the farm road the combine harvester can act as an in-field transporter by bringing newly threshed grain to the roadside. The wet grain can be off-loaded on a large piece of plastic sheeting placed on the ground where bagging of paddy will be carried out manually by the farmers. Alternatively, paddy can be bagged straight from the combine harvester. In order not to hold up the machine longer than necessary, more labour will be required if this procedure is adopted. Thereafter, sacks may be picked up by lorry for delivery to the procurement centres, as in the case of manual harvesting.

In cases where the field being harvested is a long way from the road, the combine harvester will drive up to the nearest bund where wet grain will be either bagged directly or dumped on the plastic sheet placed on the ground. In the latter case, bagging will be carried out as in the roadside situation, but with greater difficulty, because the bunds are often narrow and surrounded by wet and sticky fields. In any case, sacks of grain still have to be carted to the

TABLE 4. Distances of parcels of paddy land from the road in the Muda Irrigation Area, West Malaysia.

Distance (m)	0-250	250-500	500-750	750-1000	1000-1250	> 1250
Cases	76	22	10	4	2	4
Percentage	64.4	18.6	8.5	3.4	1.2	3.4
Cumulative percentage	64.4	83.0	91.5	94.9	96.6	100

Source: Adapted from Calverley et al. (1976)

road by in-field transport as described earlier. Owing to the physical difficulty of moving the harvested wet grain, the general shortage of labour during the harvesting season (not to mention its high cost), and the urgent need to move the crop to market, the present manual or semi-manual in-field transport is often an expensive operation for farmers and directly affects farm incomes. In-field transport cost varies between M\$1.00 to \$3.00 per sack (during September 1986, M\$2.65 = US\$1.00), depending on location, weather, field conditions, distance transported, and type of transport used. This does not include bagging, which costs another M\$0.50 to M\$1 per sack.

Moreover, delay experienced in the transport of grain of high moisture content as a result of in-field transport problems, will cause deterioration in grain quality and subsequently lower the rice recovery at milling. Teter (1983) estimated a 21% loss in value of paddy over two days delay in drying of wet paddy if held at a moisture content of 25%. Higher moisture content will result in higher rates of grain deterioration.

From the foregoing discussions, there appears to be a need to adopt an appropriate paddy bulk-handling system for quickly and efficiently moving grain from the field to procurement centres or mills, or else it will spoil. For a successful bulk-handling system to be introduced, some form of mechanised in-field transport is essential. A change is also needed to the existing paddy grading system to introduce a premium to ensure much cleaner paddy is received from the combine harvesters. The premium system will result in paddy moisture being reduced to whatever level is necessary to minimise levels of immature grain. It will also assist in reducing moisture uptake from the wet ground and rain.

The prime requirement of an in-field transporter is an ability to manoeuvre under soft and sticky soil conditions in order to receive wet crop from the combine and transport it to a waiting lorry at the edge of the farm road. Particularly during the wet season, it must have a high level of mobility and manoeuvrability. To accomplish these, a high level of flotation, uniform weight distribution, and soft-soil trafficability are essential to prevent sinking or bogging in water-logged soils. On the other hand, the vehicle must also be able to move at reasonable speed on deep moist clay with no surface water. Previous trials showed in-field transporters could get into serious trouble under such conditions, because the tyre lugs fill with mud, causing the wheels to spin, sink deeper, and finally bog down.

Eventually, the provision of in-field transport of paddy to the nearest roadside may have to be the responsibility of the combine harvester contractor.

Procurement of Paddy

In Malaysia, harvested paddy is generally released fairly quickly into the marketing system by the farmers. This is mainly due to the introduction of a paddy price subsidy scheme, the payment of which is based on sales of paddy by farmers. Another reason is the lack of speculation in the local rice trade, as both paddy and milled rice are governed by floor and ceiling prices, respectively. Table 5 indicates the source of paddy bought by mills. Large private mills and LPN complexes receive about equal proportions of their paddy from independent agents who, in turn, buy their paddy directly from the producing farmers. On the other hand, LPN procures a larger amount of its paddy from the farmers than do large private mills.

Grain transport is almost entirely owned and operated by the private sector. A survey by Calverley et al. (1976) showed that 61% of agents own or share ownership in vehicles, 53% have one or two vehicles but only 8% have more than two. The remaining 39% have to rely on hired transport. The type of transport used to deliver paddy to the mills indicated that small lorries below 2 t capacity are particularly popular because they can use the laterite farm roads and have reasonable penetration into the paddy area. Although their number is relatively small, lorries (capacity >5 t) are also important in the paddy transportation system. As a group, they carry about 51% of the total grain.

Owing to the stringent requirement for low ground contact pressure, an in-field transporter will invariably be unsuitable for highway running and will perform best as a shuttle service for moving grain from the combine harvester to a secondary transport waiting at the edge of the farm. Hence, with the conversion to bulk handling in the future, these conventional lorries can still be used with some structural modification to permit maximum carrying capacity of loose grain.

TABLE 5. Source of paddy bought by mills in the Muda Irrigation Area, West Malaysia.

Seller	Large private mills	LPN
	% purchases	
Farmer	39.6	55.2
Independent agent	37.9	43.7
Mill employed agent	22.3	-
Farmer association	0.22	0.6

Source: Calverley et al. (1976)

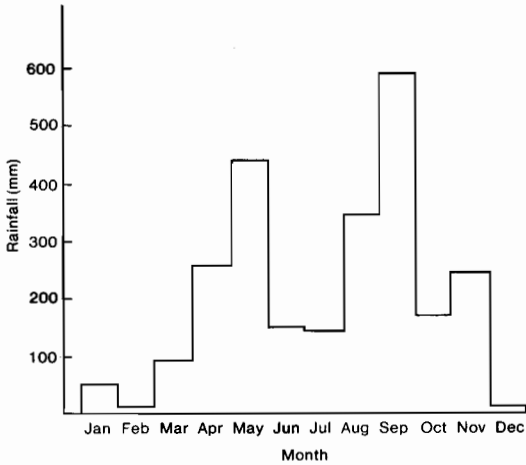

Fig. 4. Season distribution of rainfall, Alor Setar, West Malaysia. (Source: Malaysian Meteorological Service.)

Conclusion

One of the major problems faced by the grain industry in Southeast Asia is the high rate of postharvest losses. Despite considerable improvements in production technology, as well as advances in grain processing facilities, there appears to be a serious technological gap in the method of collection and transportation of grain from the field to the mills. The present practice of bag handling is very much traditional, and inefficient. For countries like Malaysia, where the opportunity cost of farm labour is high, an efficient bulk-handling system will

contribute towards reduction in postharvest losses through eliminating or minimising spillage and quality deterioration associated with the present bag handling. However, much research and development work needs to be done in order to develop an efficient in-field transporter appropriate for the adverse field conditions prevailing in most parts of the region.

References

- Ahmad, S.A. 1986. Status and problems of padi production in the Muda Irrigation Project. Presented at National Padi Conference, Malaysian Agricultural Research and Development Institute. January, 1986, Serdang, Selangor.
- Calverley, D.J.B., Street, P.R., Cree, T.J., and Dendy, D.A.V. 1976. Report on a study of the technical and economic problems of off-season padi from harvesting to post-milling storage in the Muda area of West Malaysia. London, Tropical Products Institute.
- Embi, Y. 1986. Rice production in West Malaysia — technology needs for the next decade. Presented at National Padi Conference, Malaysian Agricultural Research and Development Institute. January 1986, Serdang, Selangor.
- Khairuddin, H. 1986. Hazards the padi farmers face. *New Straits Times*, 2 September 1986, p. 10.
- Mendoza, M.E., and Quitco, R. 1984. Quality deterioration and value loss in grain. In: Frio, A.S., and Manilay, A.A., ed. *Coming to grips with the wet season grain handling problems in Southeast Asia*. Manila, ASEAN Crops Post-Harvest Programme, 15-20.
- Rohani, M.Y., Shariffah, N., and Abdullah, S. 1984. Combine harvests and their effect on padi postharvest losses in Muda Areas. Kuala Lumpur, Malaysian Agricultural Research and Development Institute.

Grain Drying Strategies for the Humid Tropics

R.H. Driscoll *

Abstract

The design and management of batch dryers is studied as an alternative to continuous-flow dryers in mill-level operation. The situation in Malaysia is studied particularly. Flat-bed batch dryers, with proper management and handling methods, give the highest quality final grain product, and can minimise deterioration of grain. However, at high moisture contents, the space required by sufficient flat-bed dryers to handle a typical wet-season load becomes prohibitive, and the drying times at high moisture contents are also prohibitive. The situation of a large procurement centre using flat-bed, first-stage dryers is shown to be a feasible alternative to existing methods, provided that the receival paddy moisture content can be controlled, such as by throwing the initiative for high moisture drying back on the farmers, either by in-field drying or sun drying. As the upper moisture content of the paddy drops, flat-bed dryers rapidly increase in effectiveness.

THE advent of combine harvesters in Malaysia has had a major effect in shortening paddy harvest times. Whereas previously the harvest in a particular area might stretch over 40 days, now the combines must strip all the paddy simultaneously in order to maximise the returns to the harvester operator. It is to some extent irrelevant if the paddy in adjacent farms is immature or suffers from lodgement; the paddy must still be harvested all at once. This condition regulates every aspect of the rice crop, because to be able to harvest at one time, the grain must be planted and flooded at the same time.

In consequence, whereas previously there was a gradual and even conveyance of paddy to the mill sites, there is now a sharp peak in the arrival rate, causing overloading of drying facilities. This effect is demonstrated in Figure 1. For the same total receival tonnage, halving the harvest length tends to double the maximum receival rate. Figure 2 shows an actual rice receival distribution. In this paper, methods of handling large peak loads are investigated theoretically, using computer simulation models of grain drying.

The optimal solution in terms of capital investment would be to have a uniform rate of paddy supply. This would require the least drying

equipment, and also optimise use of the dryers. Since the arrival of paddy is dictated by factors such as harvest times and the combine capacities, it is not possible to have a continuous flow of grain through the dryers. The grain, especially during the wet season harvest, must be dried as soon as possible, the delay time allowable depending on the temperature and moisture content history of the grain since harvesting, so it is not possible to stockpile undried grain. A dryer of sufficient capacity to handle the wet season peak load is

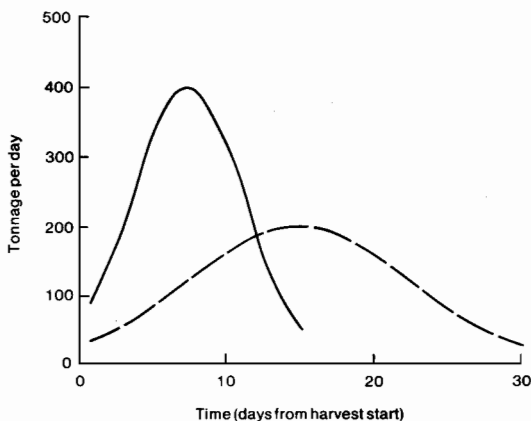

Fig. 1. Relationship between length of harvest and paddy receival rate.

* Department of Food Science and Technology, University of New South Wales, P.O. Box 1, Kensington, N.S.W. 2033, Australia.

therefore necessary, even if it must then remain idle for nine months of the year. For high moisture grain, some moisture removal must occur within the first day after harvesting to maintain optimal quality and because of this, continuous-flow dryers are generally used. In this paper, alternatives to the traditional method of complete drying using a continuous-flow dryer, are investigated.

In-bin aeration and storage is a term applied to the use of grain bins to partially dry the grain and to aerate it as necessary in order to maintain grain of high quality and low moisture content. This method has been applied by the rice industry in Australia. The climate in Australia allows complete drying of the grain within a single bin, using ambient or near-ambient air, an extremely gentle method of drying, reducing damage caused by mixing, conveying, or fast-drying the grain. Modifications of this method may be made to suit humid tropical conditions. Since ambient air is not good drying air for the wet season in the tropics, the objectives have been to minimise the supplementary heat requirement for maximum grain quality, while using sufficient heat to prevent grain deterioration. A combination of these two methods is increasingly being recognised as a feasible solution to grain storage in the tropics.

In-bin Drying

The term 'in-bin drying' is used exclusively in this paper to refer to flat-bed dryers. Conditioned air enters a plenum chamber below the rice bed, and is forced upwards through the grain, removing moisture from the grain as it does so due to the difference between the air vapour pressure and the vapour pressure exerted by the moisture contained in the grain. The humid air is exhausted from the

top of the bed. This situation has been extensively modelled, and the following references are selected as representative of the wide range of models available: Bakker-Arkema et al. (1967); Barre et al. (1971); Bloome and Shove (1971); Dung et al. (1981); Henderson and Henderson (1968); Ingram (1976); Nordon and Bainbridge (1972); Parry (1985), a review paper; Sharp (1982), a review paper; Sutherland et al. (1971); Thompson et al. (1968). The model used as the basis for the computer simulation studies at the University of New South Wales relies on Thompson's heat transfer equation describing the interaction between evaporation of moisture from the grain and the latent heat required. The resulting model assumes equilibrium exists at every point in the grain bed between the air temperature and the grain temperature, but that the moisture transfer rate between the grain and the air is dictated by the particular drying rate of the grain and the air capacity to remove the moisture.

The computer model has been developed to use actual weather data, taking into account the enthalpy rise across the fan, the pressure drop across the bed, the effect of a burner, and to simulate the effect of a controller on the input. A controller can be used in a large number of different ways. It may modify the burner output, giving inlet air temperature control, or it may switch the fans on and off in order to select the best possible ambient air conditions. This may be based on either a time control (with automatic switch-off if it rains), or a relative humidity control. Such control methods are discussed in more detail later.

In-bin drying has generally been proposed as a solution to second-stage drying only. It has been accepted by many that the first stage is most safely accomplished by the conventional, tested technology of the column dryer, and few attempts have been made to investigate alternatives. Particularly for batch dryers, it is not possible to dry the grain safely if the received moisture is too high, without requiring large flow rates and overdrying of the inlet layer of the grain bed. The resulting pressure drops are prohibitive. If the bed height is reduced to overcome this problem, the batch size becomes too small to be commercially acceptable. In the following section, the situation prevailing at a procurement centre or in mill-level drying is analysed.

Mill-level Drying Using Batch Dryers

A batch flat-bed dryer is feasible only at paddy received moisture contents below about 22–23% (wet basis), for medium to large-scale commercial operations. Above that moisture content, according to the assessment of quality developed by Seib et al.

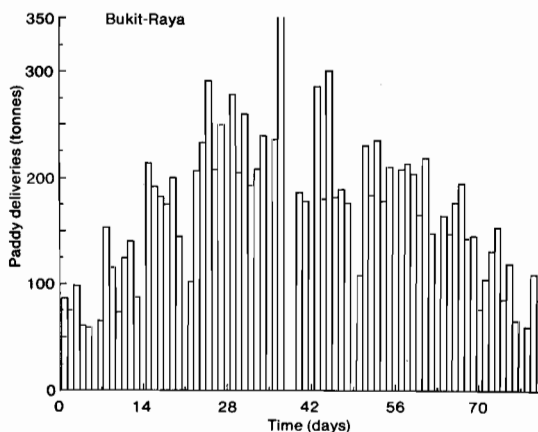

Fig. 2. Actual rice receival distribution at Bukit-Raya, Malaysia.

(1980), the grain deteriorates too quickly in the warm, humid air of the tropics for a sufficient depth of the grain to be dried. A continuous-type dryer then becomes essential. If, however, the farmer has the responsibility for ensuring that his grain is below this moisture content, a batch-type dryer becomes competitive. In the following notes, the case is considered where a mill or procurement centre receives about 100–600 t of paddy per day at the peak of the season, but the grain moisture content is not necessarily low. A method for designing batch dryers to cope with this load is discussed.

The following discussion is also qualified by economic factors, such as the availability of existing fans, burners, and bins that might be converted to the required purposes. It is not usually possible to start from nothing and completely design a new system. Rather, integration of new ideas and technology with old equipment is necessary in the short term.

Start with the paddy arriving at the mill gates, either in bulk or in bags. The paddy has been assessed for quality at the procurement centre, and its moisture content is known. The grain at present is usually directed to a continuous column dryer if it needs drying or, in Malaysia, if the dryer is busy it is piled up into tunnel configurations called Moisture Extraction Units (MEU), where large fans and burners are used to partially dry the grain until the column dryer becomes available.

This system could be modified by installing a receival hopper, so that the grain is emptied out of its bags, passes through a paddy pre-cleaner, is diverted (to a column dryer) if its moisture content is too high, and then passes to a system of batch dryers. The mode of transport is preferably automatic; that is, using conveyor belts as much as possible with the grain in bulk form. The wet paddy is allocated to different batch dryers according to factors such as moisture content and variety. The paddy is dried to an average moisture content of 18% wet basis in the batch (fast) dryers, then conveyed to large slow drying/acration/storage bins. Once the paddy has been dried to 18%, the final stage of drying may take over a fortnight without any loss of quality and, in the Philippines, paddy is often stored for over a month in this semi-dried form.

Design of a Flat Bed, Fast Dryer

A possible design procedure is described below for a mill level/procurement centre flat bed dryer. The design considerations used are:

1. the paddy deterioration level must be below about 0.4% on leaving the batch dryer, assuming it arrives at about 0.2%;

2. the top to bottom difference in the water activity value must be less than 0.3;

3. the total drying time should not be more than 24 hours and preferably about six hours per batch;

4. the final bed average moisture content is about 18% (wet basis);

5. the maximum air speed possible is 25 m/min.

At six hours per batch, two to three batches of paddy can be processed by the dryer each day. The number of batch dryers required is therefore dictated primarily by the peak receival rate and floor surface area of the dryer, and to a lesser extent by factors such as the bulk density and cleanness of the grain. For example, for a receival rate of up to 180 t/day, three batches per day, using a fully perforated floor to the dryer, and each dryer able to hold 30 tonnes, two batch dryers will be needed. The floor area of the dryers will need to be about 50 to 60 m². The floor could be inclined at the critical angle of repose for paddy (about 36°) so as to facilitate unloading, with the plenum chamber either above or below the grain. Such dryers already exist in Malaysia. We now have sufficient information to calculate the required airflow through the dryer.

Assume the average receival paddy moisture content is 21% (wet basis). Assume also that the average ambient drying conditions are 28°C and 80% relative humidity (RH). Simulation results (see Fig. 3) indicate that a 0.7 m bed can be dried to 18% average moisture content in about 6.5 hours, using a heat rise of 4.5°C and an air speed of 20 m/min, without creating an excessive top to bottom water activity difference (the actual value for the simulation was 0.30). However, at 22% moisture content (wet basis), an air speed of 25 m/min was necessary for the same results (see Fig. 4). In both cases, the dry matter loss value was small during drying. This illustrates the value of controlling the moisture content of the receival rice. Figures 5 and 6 are diagrams designed for operating batch dryers, allowing the operator to predict the drying time of the current batch in terms of the ambient conditions. They may also be used for developing strategies or designing fast dryer bins.

There are many parameters that can be controlled in order to give an appropriate drying solution for varying receival moisture contents. The two most commonly used are bed depth and drying time. Figure 5 gives required bed depths for different moisture contents, for the conditions:

drying time	6 hours
ambient conditions	28°C and 80% RH
supplementary heat	1.5°C (fan) + 4.5°C (burner).

The next aspect of the design to be considered is what size fan and burner are needed to optimise

drying time and grain quality. Considerable research has been done on pressure drops across fixed beds, for example, the studies by Agrawal and Chand (1974), Akritidis and Siasstras (1979), Calderwood (1973), Fitzpatrick (1977), Gunajekaran et al. (1983), Intong (1982), Osborne (1961), Patterson et al. (1971), Pierce and Thompson (1975), and Williamson (1965). Using the pressure drop, the fan size required can then be calculated, and the type of fan chosen based on whether uniform air speeds are

required for different grain depths and porosities or not. An estimate of the required air speed is necessary in order to calculate the pressure drop and hence choose the fan size.

This critical air speed is determined by the need to dry the paddy fast enough to prevent grain deterioration. That is, either the drying front must reach all of the grain within a maximum time limit determined by the rate of deterioration, or the batch dryer must be emptied and the grain mixed by

INPUT RECORD

Bed height 0.7 m in 20 layers of thickness 0.04 m
Run time 8.0 hours in 0.50 hour increments

DATA

Porosity 0.45
Grain temp. 20.00
Air temp. 28.00
Initial m.c. 21.00
Equil. m.c. 16.06
Inlet air r.h. 80.00
Airflow rate 20.00
Fan heat rise 1.50
Burner heat rise 4.50

RICE ASIA

MODE

I/O FILES

Output datafile: sim.3

Output plotfile:

Input air file:

Input bed file:

STRATEGIES

RH		FAN		BURNER	
up	low	on	off	on	off
0	0	0	0	0	0

OUTPUT RECORD

time	fan	burner	on/off	M (av)	M (in)	M (out)	DML	RH
0.0	0.0	0.0	1 1	21.00	21.00	21.00	0.0384	91.75
0.5	0.5	0.5	1 1	21.00	19.48	21.20	0.0421	92.60
1.0	1.0	1.0	1 1	20.79	18.41	21.27	0.0471	92.84
1.5	1.5	1.5	1 1	20.55	17.59	21.28	0.0520	92.87
2.0	2.0	2.0	1 1	20.30	16.94	21.28	0.0565	92.88
2.5	2.5	2.5	1 1	20.05	16.39	21.28	0.0608	92.88
3.0	3.0	3.0	1 1	19.80	15.93	21.28	0.0647	92.88
3.5	3.5	3.5	1 1	19.54	15.53	21.28	0.0684	92.88
4.0	4.0	4.0	1 1	19.28	15.18	21.28	0.0718	92.88
4.5	4.5	4.5	1 1	19.02	14.87	21.28	0.0750	92.88
5.0	5.0	5.0	1 1	18.76	14.59	21.28	0.0780	92.88
5.5	5.5	5.5	1 1	18.50	14.35	21.27	0.0807	92.87
6.0	6.0	6.0	1 1	18.24	14.13	21.26	0.0833	92.84
6.5	6.5	6.5	1 1	17.97	13.93	21.24	0.0856	92.79
7.0	7.0	7.0	1 1	17.70	13.74	21.20	0.0878	92.67
7.5	7.5	7.5	1 1	17.44	13.58	21.13	0.0898	92.43
8.0	8.0	8.0	1 1	17.17	13.43	21.01	0.0916	92.00

FINAL BED STATE PER TONNE (at 6.5 hours)

Initial weight dry grain	790 kg	Weight moisture loss	41 kg
Initial weight moisture	210 kg	Final weight moisture	169 kg
Final moisture content	17.7 %wb	Final grain quality	0.09 %
POWER COSTS	UNITS	FAN POWER	BURNER POWER
Power consumption	kW	1.350	3.839
Total energy used	kWhr	9.452	26.870
Energy per kg water	kWhr/kg	0.23053	0.65536
Energy per percent water	kWhr/%	1.8642	5.2995

Fig. 3. Record of fast-drying simulation of 21% moisture content paddy using University of New South Wales grain drying model.

outloading within this maximum time limit.

The first possibility assumes that the bed is shallow enough to permit the drying front to reach the top of the bed before the bed average moisture content has reached 18%. This is an ideal situation, because the grain is dried uniformly and mixing of wet grain with dry grain is avoided. In practice, it may be an expensive solution, because as soon as the drying front reaches the top of the bed, the effective usage of the air decreases with the outlet relative humidity. Further, the bed will be too

shallow to handle commercial amounts of grain. The leading edge of the drying front may reach the top of the bed, and will generally do so, but the majority of the drying front should remain below the bed surface during fast drying.

The second possibility will therefore be the normal situation. However, there are problems here as well. If wet grain is mixed with dry grain, such as usually happens to a large extent during grain unloading, the quality of the grain decreases due to interchange of moisture. It is well recognised that

INPUT RECORD

Bed height 0.7 m in 20 layers of thickness 0.04 m
Run time 8.0 hours in 0.50 hour increments

DATA

Porosity 0.45
Grain temp. 20.00
Air temp. 28.00
Initial m.c. 22.00
Equil. m.c. 16.06
Inlet air r.h. 80.00
Airflow rate 25.00
Fan heat rise 1.50
Burner heat rise 4.50

RICE ASIA
MODE

I/O FILES

Output datafile: test.dat
Output plotfile:
Input air file:
Input bed file:

STRATEGIES

RH		FAN		BURNER	
up	low	on	off	on	off
0	0	0	0	0	0

OUTPUT RECORD

time	fan	burner	on/off	M (av)	M (in)	M (out)	DML	RH
0.0	0.0	0.0	1 1	22.00	22.00	22.00	0.0527	93.28
0.5	0.5	0.5	1 1	21.94	20.19	22.21	0.0577	94.00
1.0	1.0	1.0	1 1	21.66	18.97	22.26	0.0645	94.16
1.5	1.5	1.5	1 1	21.35	18.05	22.27	0.0710	94.18
2.0	2.0	2.0	1 1	21.04	17.32	22.27	0.0769	94.19
2.5	2.5	2.5	1 1	20.72	16.72	22.27	0.0824	94.19
3.0	3.0	3.0	1 1	20.40	16.22	22.27	0.0874	94.19
3.5	3.5	3.5	1 1	20.07	15.78	22.27	0.0920	94.19
4.0	4.0	4.0	1 1	19.74	15.41	22.27	0.0962	94.18
4.5	4.5	4.5	1 1	19.41	15.08	22.27	0.1001	94.18
5.0	5.0	5.0	1 1	19.08	14.78	22.26	0.1036	94.17
5.5	5.5	5.5	1 1	18.74	14.52	22.24	0.1068	94.13
6.0	6.0	6.0	1 1	18.41	14.28	22.19	0.1097	94.02
6.5	6.5	6.5	1 1	18.07	14.07	22.08	0.1123	93.71
7.0	7.0	7.0	1 1	17.73	13.88	21.89	0.1147	93.05
7.5	7.5	7.5	1 1	17.40	13.70	21.62	0.1168	91.96
8.0	8.0	8.0	1 1	17.08	13.54	21.30	0.1187	90.46

FINAL BED STATE PER TONNE (at 6.5 hours)

Initial weight dry grain	780 kg	Weight moisture loss	52 kg
Initial weight moisture	220 kg	Final weight moisture	168 kg
Final moisture content	17.7 %wb	Final grain quality	0.11 %
POWER COSTS	UNITS	FAN POWER	BURNER POWER
Power consumption	kW	2.407	4.798
Total energy used	kWhr	16.849	33.587
Energy per kg water	kWhr/kg	0.32403	0.64590
Energy per percent water	kWhr/%	2.5337	5.0506

Fig. 4. Record of fast-drying simulation of 22% moisture content paddy using University of New South Wales grain drying model.

once grain is dried to below a certain moisture content it cannot be rewetted quickly without generating fissures in the grain (Chau and Kunze 1982; Chen and Kunze 1983; Kunze and Choudhury 1972; Stermer 1968; J.A. Darby, personal communication), and possible consequent breakage during milling. Thus, the moisture content of the bottom layer must be either above about 14% (which makes the drying time too long), or the top-to-bottom difference in grain water activity levels must be below about 0.3, so that re-equilibration of moisture between the top and bottom layers, when they are mixed, occurs sufficiently slowly to prevent fissuring. These quality limits are also necessary in designing the fast dryer. If the grain is coming in at above about 20% moisture content (wet basis), then the top layer of the bin has an equilibrium relative humidity of about 95%. This means that the bottom layer of the bin should not be dried below about 14% moisture content (wet basis) in order to maintain a top-to-bottom water activity difference below 0.3. Grain at 14% moisture content (wet basis) has an equilibrium relative humidity of 65 to 70%. However, since the inlet grain layer takes some time to come to equilibrium with the inlet air, it is possible to use air at relative humidities lower than 70%. If this were not possible, the method would not be feasible, since the drying time would be too long. Table 2 gives details of a simulation of a 0.7 m bed dried from 22% moisture content (wet basis) using an air speed of 25 m/min, with inlet air at 55% RH. The bottom layer remains above 14% for over six hours, at which stage the average grain moisture content is about 18% (wet basis). Thus, six hours is the time required for fast drying under these conditions. If times longer than six hours are

used in this case, the grain cannot be mixed without some quality loss, manifested as increased levels of broken after milling.

Design and Strategies for a Slow Dryer

The design of the second-stage dryer is similar, but on a larger scale. The slow dryer has about three weeks to dry the grain. Therefore, to make the maximum use of slow, gentle drying, the combined slow dryer capacities must be roughly equal to the total harvest receipt of the mill site, since the harvest duration is generally about 30 days for the wet season. Then the role of slow dryer and pre-mill aerated storage can be combined. For each bin, for maximum efficiency, the grain should be loaded to sufficient depth to start using the fans as soon as possible after loading commences. This also minimises grain deterioration. This is enough information to estimate the floor area of each dryer and the number of dryers required, assuming a maximum grain depth of 4 m. (Bed depths greater than 4 m have given poor results in the tropics).

Of more interest are strategies for the second stage. Assuming the grain arrives at the slow dryer stage at or below 18% moisture content (wet basis), the following strategies for drying the grain were simulated for Kota Bahru and Alor Setar in Malaysia, and Bangkok, Thailand:

- continuous, deep bed drying;
- relative humidity control;
- time control.

All strategies were simulated with varying degrees of supplementary heat. Many more drying strategies are possible; the ones chosen are the simplest. Further, combinations of strategies are necessary in many cases. For example, decreasing the relative humidity band (the difference between the upper and lower relative humidity limits) is the fastest strategy for a given supplementary heat supply, and the gentlest. Space prohibits investigating all of these possibilities at once, so only those listed were compared.

Figure 7, which relates to continuous, deep bed drying, plots the time in days against the average moisture content of a 4 m bed being aerated at a flow rate of 6 m/min, for the three locations. Each simulation was repeated for +0, +3, +6, and +9 degrees of heat added to the air used for drying. This heat is the total heat added by both the burner and the fan. The grain is aerated 24 hours per day. The optimal strategy for all locations was to add three degrees of heat. Less than this was insufficient, more than this dried the grain faster than necessary, resulting in overdrying problems for the grain layer nearest the inlet.

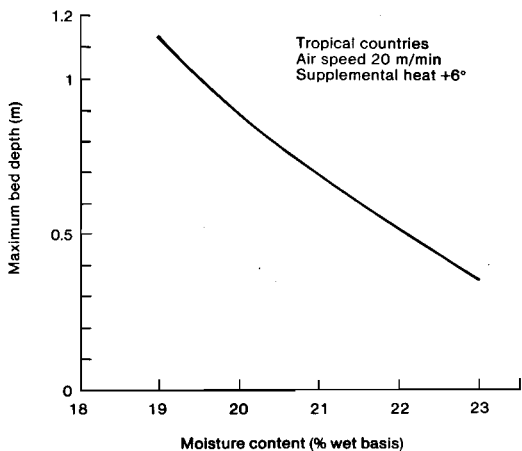

Fig. 5. Graph for predicting maximum allowable depth of grain in a batch dryer as a function of grain moisture content.

Figure 8 plots time against average moisture content for the relative humidity control strategy. In this strategy, both fans and burners are used if the ambient air relative humidity is less than 80%. In all three cases, Bangkok has by far the best drying weather. In general, the best solution now is to add about 6 degrees of heat to the inlet air.

Fig. 6. Graphs for predicting drying times in a batch dryer as a function of relative humidity, temperature, and airflow rate.

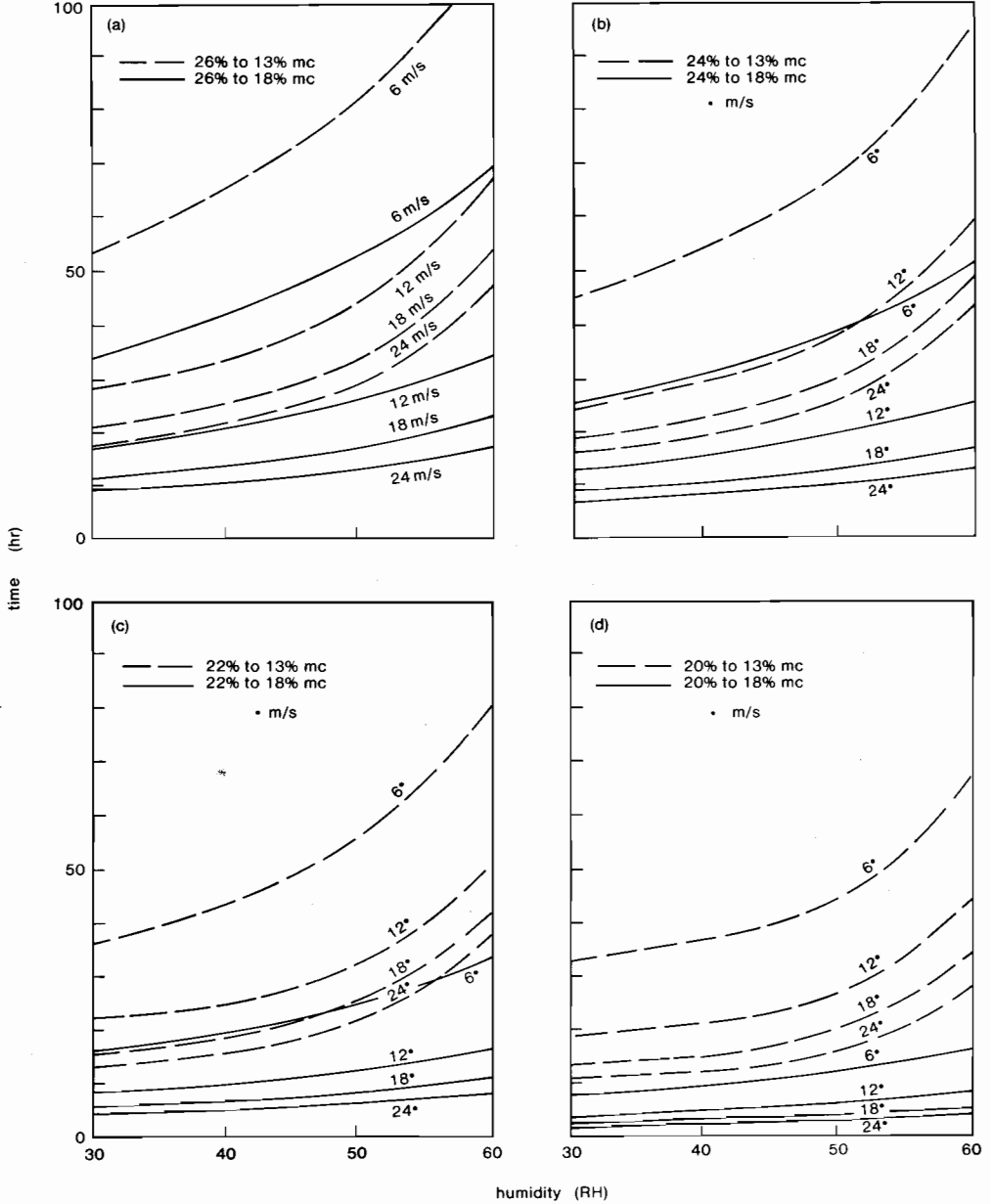

Figure 9 is a plot of time versus moisture content using a time control strategy. For Australian conditions, it has been shown that there is little effective difference between a time control strategy and a relative humidity strategy. However, the results of the simulations here indicate that a three-degree temperature rise is sufficient. The upper limit of 80% in the relative humidity control is thus lower than necessary, if supplementary heat is used. Note that in both Figures 6 and 7, the time axis is the total

elapsed time, not the actual drying time, which is considerably less.

Finally, Figure 10 summarises the energy costs for each strategy. The fan costs are marked by circles, and the corresponding burner costs are marked at the same domain axis position with crosses. In most countries, the burner cost per kWh will be about one-quarter of the electricity cost. In all cases, the time control strategy at three to six degrees is superior in terms of running costs.

It is possible to have sophisticated controllers connected to sensors in the grain bulk. The controllers can determine the optimal strategy at any time based on the grain moisture, ambient air conditions, and time since grain delivery. A controller could choose to use large amounts of air

after the grain had first been loaded, then subsequently less air until the required milling/storage moisture content was obtained. After this, it could run a maintenance control strategy to keep the grain in optimal condition until milling.

Layer filling was a popular idea in the American literature for a short time. However, the demands of receiptal made it difficult to implement. The principle is as follows: wet grain is loaded into the flat-bed bulk dryer, and immediately the fans are started. The progress of the drying front is monitored, and just before the drying front breaks through the top of the bed, more wet grain is loaded into the bin. This method optimises fan usage (since the fan is not working against the large pressure drop of a full bin) and quality (since new grain is

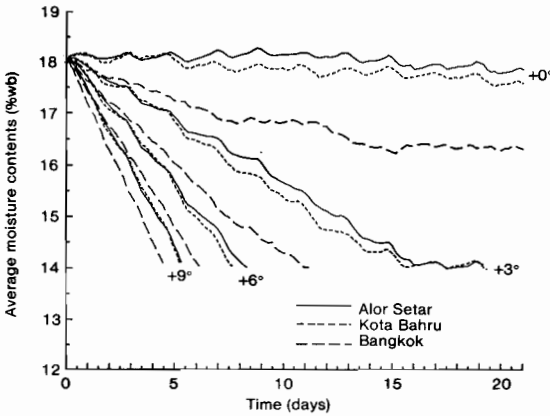

Fig. 7. Simulated drying times for a 4 m bed of grain aerated at a flow rate of 6 m/min, at three different locations, and with +0, +3, +6, and +9 degrees of supplemental heat. See text for further explanation of this constant supplementary heat strategy of drying.

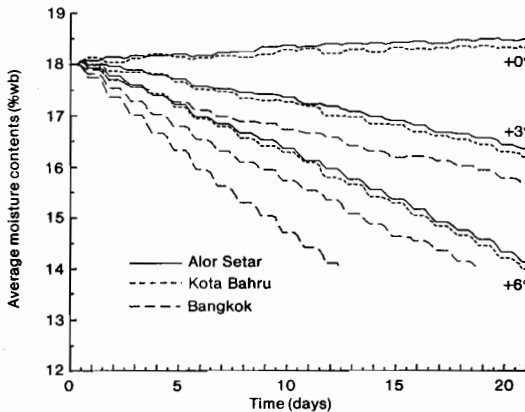

Fig. 8. Simulation of relative humidity control strategy for grain drying, with four levels of supplemental heat. In this strategy, both fans and burners are used if the ambient air humidity falls below 80%.

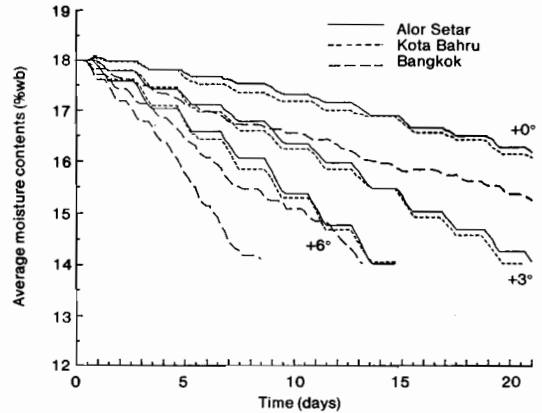

Fig. 9. Plot of time versus grain moisture content for a time control strategy of grain drying.

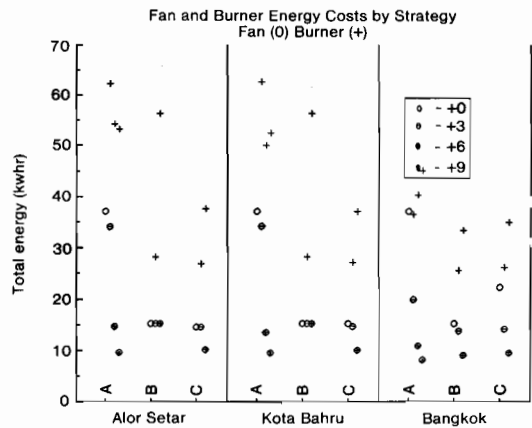

Fig. 10. Summary of energy costs for supplemental heat (A), relative humidity control (B), and time control (C) strategies of grain drying.

dried almost as quickly as it arrives). Layer filling is still a recommended technique, but even when it is not possible as a formal practice, many of the benefits of layer filling can be realised by spreading the received paddy around several bins, instead of fully loading one bin first.

Acknowledgment

The research reported was carried out in an ACIAR-funded project on in-bin aeration and storage of grains in the humid tropics.

References

- Agrawal, K.K., and Chand, P. 1974. Pressure drop across fixed beds of rough rice. *Transactions of the American Society of Agricultural Engineers*, 17, 525-527.
- Akritidis, C.B., and Siasstras, A.J. 1979. Resistance of pumpkin seeds to air flow. *Transactions of the American Society of Agricultural Engineers*, 22, 1414-1416.
- Bakker-Arkema, F.W., Bickert, W.G., and Patterson, R.J. 1967. Simultaneous heat and mass transfer during the cooling of a deep bed of biological products under varying inlet conditions. *Journal of Agricultural Engineering Research*, 12, 297-307.
- Barre, H.J., Baughmann, G.R., and Hamdy, M.Y. 1971. Application of the logarithmic model to cross-flow deep-bed grain drying. *Transactions of the American Society of Agricultural Engineers*, 15, 1061-1064.
- Bloome, P.D., and Shove, G.C. 1971. Near-equilibrium simulation of shelled corn drying. *Transactions of the American Society of Agricultural Engineers*, 14, 709-712.
- Calderwood, D.C. 1973. Resistance to airflow of rough, brown and milled rice. *Transactions of the American Society of Agricultural Engineers*, 16, 525-527.
- Chau, N.N., and Kunze, O.R. 1982. Moisture content variation among harvested rice grains. *Transactions of the American Society of Agricultural Engineers*, 25, 1037-1040.
- Chen, V.L., and Kunze, O.R. 1983. Effect of environmental changes on rice yield and particle size of broken kernels. *Cereal Chemistry*, 60, 238ff.
- Dung, N.V., Bowrey, R.G., and Fowler, R.T. 1981. Simulation of drying in ventilated paddy rice stores. *Food Technology in Australia*, 33, 173-175.
- Fitzpatrick, T.S. 1977. Pressure loss through aerated rice beds. Richardson Research Department Project RS.341.
- Gunajekaran, S., Jindal, V.K., and Shove, G.C. 1983. Resistance to airflow of paddy (rough rice) in shallow depths. *Transactions of the American Society of Agricultural Engineers*, 27, 601-605.
- Henderson, J.M., and Henderson, S.M. 1968. A computational procedure for deep-bed drying analysis. *Journal of Agricultural Engineering Research*, 13, 87-95.
- Ingram, G.W. 1976. Deep-bed drier simulation with intraparticle moisture diffusion. *Journal of Agricultural Engineering Research*, 21, 263-272.
- Intong, D.L. Jr. 1982. The effect of porosity, moisture content, cleanliness and method of packing on pressure drops in deep-bed grain bin aeration of two Australian paddy varieties. Sydney, University of New South Wales, M.Sc. thesis.
- Kunze, O.R., and Choudhury, M.S.U. 1972. Moisture adsorption related to the tensile strength of rice. *Cereal Chemistry*, 94, 684-696.
- Nordon, P., and Bainbridge, N.W. 1973. Heat and moisture exchange in wool beds; equilibrium theory in the hygroscopic range. *Journal of the Textile Institute*, 63, 429-441.
- Osborne, L.E. 1961. Resistance to airflow of grain and other seeds. *Journal of Agricultural Engineering Research*, 16, 119-122.
- Parry, J.L. 1985. Mathematical modelling and computer simulation of heat and mass transfer in agricultural grain drying: a review. *Journal of Agricultural Engineering*, 32, 1-29.
- Patterson, R.J., Bakker-Arkema, F.W., and Bickert, W.G. 1971. Static pressure-airflow relationships in packed beds of granular biological materials such as grain — II. *Transactions of the American Society of Agricultural Engineers*, 14, 172-178.
- Pierce, R.O., and Thompson, T.L. 1975. Airflow patterns in conical-shaped piles of grain. *Transactions of the American Society of Agricultural Engineers*, 18, 946-949.
- Seib, P.A., Pfost, H.B., Sukabdi, A., Roa, V.G., and Burroughs, R. 1980. Spoilage of rough rice as measured by the evolution of carbon dioxide. In: *Proceedings of 3rd annual workshop on grains postharvest technology*. College, Laguna, Philippines, Southeast Asia Cooperative Post-Harvest Research and Development Program, 75-94.
- Sharp, J.R. 1982. A review of low temperature drying simulation models. *Journal of Agricultural Engineering Research*, 27, 169-190.
- Stermer, R.A. 1968. Environmental conditions and stress cracks in milled rice. *Cereal Chemistry*, 45, 365 ff.
- Sutherland, J.W., Banks, P.J., and Griffiths, H.J. 1971. Equilibrium heat and moisture transfer in airflow through grain. *Journal of Agricultural Engineering Research*, 16, 368-386.
- Thompson, T.L., Peart, R.M., and Foster, G.H. 1968. Mathematical simulation of corn drying — a new model. *Transactions of the American Society of Agricultural Engineers*, 11, 582 ff.
- Williamson, W.F. 1965. Pressure losses and drying rates in grain ventilated with various on-floor duct systems. *Journal of Agricultural Engineering Research*, 10, 271-276.

Grading, and Maintaining Grain Quality in Storage

J.H. Baird *

Abstract

The factors that influence grain quality, and their relative importance on grading of grain, are discussed. Emphasis is placed on basic causes of grain quality deterioration immediately after harvest. The inhibitory effects on an adequate grading system of a range of inadequate postharvest facilities and practices are identified. The establishment of an objectively based grading system for paddy rice is given prominence over standards for milled rice. The pressure for international standards is questioned. Criteria for an effective paddy grading system are set down and the rationale for selection of quality characteristics for national grading systems within the ASEAN region is given. Grade parameters are not suggested: these should arise from independent national data collection. Storage hygiene and sanitation are essential components of strategies for maintaining grain quality after harvest.

GRAINS postharvest technologists are currently putting more time and effort into the reduction of storage losses than into any other postharvest area. This is not to say that other areas of grains postharvest technology have been disregarded, or that all the other problems have been solved. Rather, it has been recognised that if we are to minimise food losses we must look at the area where most of these losses occur. This has been identified as the storage area.

It has been shown that it is not sufficient to measure the losses incurred by the depredations of rodents, birds, and insects, the physical loss of moisture, and wastage incurred by a variety of grain handling techniques. We must also take steps needed to eliminate qualitative losses which in some instances do not appear until later in the postharvest chain. But appear they do — in quite dramatically quantifiable ways.

Apart from the obvious or easily recognised damage to grain by insects and moulds, we are faced with heavy losses in the processing of damaged and *substandard* grain. Further, much of the substandard grain is so qualitatively substandard that it cannot be processed for safe or acceptable human consumption.

So, what do we mean by this term 'qualitatively substandard'? Clearly, it implies that there must be some qualitative standards: standards by which we measure and compare certain quality characteristics. This measured comparison of recognisable quality characteristics can be described as 'grading'.

It is appropriate, therefore, that we should have not only a thorough and agreed understanding of terms such as 'standards', 'grades', and 'quality', but also an understanding of why we require standards, how we define 'quality', and how we determine 'grade'.

I propose to devote this paper to paddy and milled rice, as these are the commodities with which I have had direct experience, but I have no doubt that much of what I present to you is valid and applicable to other commodities.

Objectives of Standards and Grades

As recently as March 1985, the subject of rice grading, inspection and analysis was given the attention of an FAO/UNDP regional field workshop in Pakistan. It was attended by participants from 11 countries: all presented papers on the status of grading systems and practices in their rice industries. Perhaps the highlight of the workshop output could be said to have been the wide variation in the 'state of the art' between the 11 countries, ranging from the sophisticated

* Rice Postharvest Consultant, 44 Mossman Court, Noosa Heads, Queensland 4567, Australia.

procedures of Japan to the experimental procedures of Vietnam and, perhaps I should say the Philippines, where I have personally been involved.

The differences in emphasis between the importance of grading paddy quality and milled rice quality were also evident at this workshop, and these differences are of course, with the exception of Japan, related to the relative importance of rice as an export commodity to the producing nation. It may also be seen to be related to the social philosophies of the particular country's government.

I have no argument with these differences in emphasis, because I see the validity of the relationships. At the same time, however, I find it difficult to reconcile the fact that certain countries have gone to quite extraordinary detail in establishing their national standards and grades for milled rice, providing admirable objective measurement procedures, whilst they have placed the standards and grades for paddy either in the 'too hard' basket, leaving it to the private sector to work out for itself, or have arbitrarily set standards with little or no guidance as to how the quality characteristics reflected by these standards can be objectively measured.

There is, however, universal acknowledgment of the fact that, just as we cannot make good omelettes from rotten eggs, we cannot produce high-quality milled rice from low-quality paddy. Therefore, logically and imperatively, we must move our emphasis to the objective measurement of those quality characteristics of paddy which will be reflected in the required standard and grade of the milled product.

I would also point out in passing, that no matter how we set our standards and grades for export milled rice, we will ultimately make our sales and achieve our prices on the basis of buyer satisfaction. Because of this, it is my contention that we must first concentrate our efforts as technical people on ways and means of quantitatively measuring quality characteristics in paddy, positively identifying the cause of defects, and providing the postharvest facilities and practices to minimise or eliminate them. The relationship between paddy quality and milled rice quality is clear. It is the how, why, when, and where we determine paddy quality that is not so clear.

Much has been said and written about the need for international standards for all grains in international trade, and FAO has been very much at the forefront of the effort to have these established and promulgated. My personal support for this program is qualified. Inasmuch as international standards positively identified fitness for human consumption, I would fully endorse

them. However, I am unable to find common ground with the advocates of international standards and grades that reflect what may well be only cosmetic quality differences. This is what the market can decide without help from bureaucrats. I unequivocally support an international glossary of terms and definitions, and I believe we have come a long way towards this, but even here we still have some way to go.

Paddy rice is not generally recognised as an export commodity. Paddy is, in any case, a generic term covering a huge number of varieties produced under widely disparate conditions. To attempt to introduce international standards and grades for paddy is, in my opinion, to fail to recognise the enormous range of these conditions and would almost certainly create greater national problems than it solved.

In saying that, I want it to be clearly understood that I am not rejecting international guidelines for the measurement of quality characteristics in national grading systems. Neither am I rejecting international definitions. I am simply saying that *national* standards for the *internal* marketing of paddy are in greatest need of our attention, and these can be set only with a full understanding of the climatic, economic, political, agronomic, and social conditions under which the paddy is produced. We must consider the whole ambit of postharvest facilities which are currently available and perhaps likely to become available in a particular country in the near future. These vary greatly within the ASEAN region itself, let alone between this and other regions.

Factors Affecting Standards and Grades

The design and introduction of an effective, workable set of national standards and associated grades for paddy (and milled rice) demands a fairly complete knowledge and understanding of facilities and practices immediately after harvest, including:

- storage of unthreshed, cut paddy;
- threshing practices;
- storage of threshed paddy;
- drying of threshed paddy;
- transportation facilities;
- marketing system and payment to farmers.

Let me briefly identify or reidentify for you the difficulties and inhibitions that these factors impose upon us — and let it be realised that all of these factors are contingent on one another and should not be studied in isolation when we are planning our quality assurance system.

Storage of Unthreshed Paddy

Unthreshed paddy is stored in a number of ways, the worst practices being the most prevalent. Cut

paddy is laid on stubble where it may or may not be lying in water or otherwise very wet. There are many areas where single irrigation schemes serve a large number of small farms, and under multiple-cropping conditions it is not unusual to have planting and harvesting going on in adjoining plots simultaneously. Cut paddy (however wet) is bundled and stacked in various ways, the worst being in quite large field stacks that may be left for several days before threshing takes place. Within 24 hours such paddy has begun to ferment and its grade is accordingly lost. Cut paddy can be suspended or even stacked in a way that will minimise the problem, but more immediate threshing after harvesting is a better solution.

Threshing Practices

Apart from the large and small auto-headers or mechanical harvesters which cut and thresh in the same operation, a variety of threshing systems is used in the region: hand; small, farm-owned and operated machines; commercial itinerant equipment. Breakage of grain and the failure to properly winnow the threshed grain are the two most common threshing faults affecting grain quality. The effect of broken grain is of course self-evident, but the importance of trash-free grain in the drying and storage phase is too often overlooked. The absence of trash or light impurities is fundamental to safe and effective mechanical and in-store drying.

Drying of Threshed Paddy

Any consideration of drying practices must include storage. Again, it is vital to grade characteristics that drying take place as quickly as possible after threshing. Present practices and/or conditions do not in the main permit this. Solar drying is by far the most prevalent method, although small batch dryers (supplemental heat, forced-draft static-bed units) are also used, as are many mechanical dryers of varying types and capacities.

Where any real attention has been paid to drying in the past, its first objective has been to get paddy dry enough (14% moisture content) for subsequent safe storage. Whilst this is a primary requirement, the next step in quality improvement is control of the drying phase. The ultimate test of paddy quality is its milling yield (or recovery), particularly the whole grain or head rice yield. Although safe storage conditions may have been achieved, they are almost invariably achieved without control, and extensive cracking of the grain takes place. Overdrying causes qualitative as well as quantitative losses, and drying without proper appropriation of the time/temperature/moisture relationships can bring about equal or greater losses.

In many parts of the ASEAN region, thought could well be given to the establishment of municipal, district, regional, or cooperative drying facilities operating on a fully commercial basis. Such a step, or alternatively the establishment of large-scale mechanical commercial dryers, alone or in conjunction with the more recently developed in-store drying facilities and operated by private or government agencies, would be of tremendous value in the prevention of qualitative and quantitative losses, and would give meaningful support to an effective grading system.

Transportation Facilities

Currently, transportation facilities throughout the region cannot be said to match the need for fast delivery of threshed and undried paddy. Quite clearly, any steps taken to improve storage, threshing, and drying facilities will involve concomitant improvements in transportation facilities, an issue that I am sure will receive considerable attention during this seminar.

Marketing System and Payment to Farmers

This is a key factor in the development of any paddy grading system. Let me specifically refer to the system in the Philippines. Currently, the National Food Authority procurement system provides that paddy is 'graded' at the time of its presentation at a procurement station, and the allotted grade immediately commands a fixed price, with or without certain incentive payments according to particular conditions applying. The farmer is paid by cash or cheque according to the size of his delivery. If a disbursement officer is present at the station, the farmer is paid immediately. Otherwise, he must represent himself to collect the payment due against his warehouse receipt on a date or at a time when the officer is present. In places where a disbursement officer is not present every day, the waiting time is usually no more than two days. Nevertheless, farmers complain about the delay and inconvenience. The private sector is also committed to a cash-on-delivery system with its own variations. Despite these pressures for immediate payment, the grading system must not be arbitrary; neither should the grade be determined by purely subjective methods. Grade characteristics must be measured by objective methods and be seen to be so measured. Premiums and penalties must be capable of prompt calculation to the satisfaction of the negotiating parties. Payment-in-kind or barter systems must be recognised as an acceptable method of payment. They introduce a different dimension to the establishment of grade premiums and penalties.

The Selection of Grade Characteristics

The selection of quality characteristics to be measured and the grading parameters to be set must be a reflection of our understanding of the six factors just outlined, and our capacity to apply improved technology where it is warranted. We must select those characteristics of paddy quality which can be measured objectively and which we believe provide a sufficiently accurate index of overall paddy quality to permit their selection as essential grade characteristics for the fair marketing of the commodity. The standards or parameters for the various grades can then be arrived at by statistical analysis of the collected data.

One further point: in developing any system of standards and grades it is necessary to identify its relevance to farmers, millers, and consumers, and to observe the precept that there is no point whatsoever in drawing up a system of standards and grades that is unattainable, for whatever reason, by those involved.

The techniques and methods which have been developed in the Philippines are considered to be practical and workable, and call for only average skills on the part of the grading personnel. The system may not meet the demands of the purists, as it necessarily eschews 'n'th degree accuracy. Results, however, have conclusively indicated repeatability and the indication of quality differences sufficient to allocate grade fairly. Refinements of equipment and method will no doubt come and they will be welcome.

Should other countries wish to apply this philosophy to their grading systems they need have no fear of breaching international standards for the procurement of paddy. There are none.

Let me now suggest to you a rationale for a paddy grading system. This may be of some assistance to those countries who believe they have a need for national standards and grades or perhaps a need to improve on their existing system.

A Paddy Grading System

System Criteria

A workable system of standards and grades must be one which:

- is acceptable to all parties concerned;
- will, in fact, provide repetitively identifiable grade differences;
- will fit the procurement/purchasing system in respect to payments to farmers.

The Development of Grade Standards

Various quality characteristics are to be identified as those which should be addressed in the setting of grading parameters within any system of standards

and grades for paddy and milled rice. These are listed below with some comments providing the rationale for a system that meets the criteria mentioned above.

Quality Characteristics

Varietal purity. Normally, 'varietal purity' in grain standards is given definition under the heading of 'contrasting types'. The definition refers to only physical characteristics (size and shape) and not to other important aspects, such as cooking quality, aroma, texture, and taste. It is nonetheless (and for good reasons) recognised throughout the world as an important grade characteristic in the marketing of brown or milled rice.

The importance of varietal purity or contrasting types/classes is well understood by rice millers, perhaps less understood by rice producers. Every component of modern rice-milling technology has a variable factor related to varietal characteristics.

Unless the national industry has an effective system of pure seed distribution, it will be unfair to all concerned to establish premiums and penalties based on this characteristic. The primary cause of the fault should be rectified first.

Moisture content. This is a prime characteristic for the procurement of paddy. The results of storage of paddy with excessive moisture content are well known. It is a characteristic which is readily and rapidly measurable with a wide range of available equipment. However, it should be recognised that head rice recovery depends more on how the paddy is dried than on any set limit of moisture content itself.

All grades should be required to meet a standard of 14% moisture content (m.c.), considered a maximum for safe storage. All procurement/purchase weights should be adjusted to this standard for payment purposes in the event of paddy being procured at moisture contents above 14%. Paddy purchased below 14% m.c. should be purchased at weighbridge weight. An equivalent net weight system should be applied to paddy purchased at more than 14% m.c. and a drying charge may well be included.

Moisture content is an essential grade characteristic.

Impurities. This is by far the greatest down-grading factor recognised in paddy procurement/purchase. Subjective assessments have been proved grossly unreliable and it is not claimed that objective measurement facilities available for use at paddy buying stations can provide a complete measure of this characteristic. Impurities include heavy and light materials. The heavy materials are non-rice based. However, the rice-based materials are likely to exceed in quantity the heavier non-rice based

impurities in the regional harvest systems, and they are major contributors to grains damage in storage and inefficiencies in storage and drying systems. Therefore, for the purpose of a grading system these light impurities are measured quantitatively and used as a grade factor. This can be done effectively and rapidly at the buying station.

Immaturity. The presence of immature grains is a downgrading factor for paddy. They contribute to poor appearance and cooking quality of milled rice if they survive the milling process. They reduce production yields and severely lower milling yields, breaking and grinding more easily than mature grains and in fact contributing to the breakage of mature and sound grains in the milling process.

Most immature grains are 'chalky' in appearance and consequently are often classified conjointly with 'chalky grains'. For reasons to be explained, it is not correct to do this.

Immaturity can be objectively measured by the use of 'thickness graders'. The method has some room for refinement, but sensibly applied it serves as a valuable grade determinant.

Chalkiness. Chalkiness is a varietal characteristic often confused with immaturity as a grade characteristic. Varietal choice and/or improvements could eliminate chalkiness other than that associated with immaturity. It is a factor which is non-measurable by rapid mechanical means and cannot be effectively incorporated in grading of paddy at procurement. Segregation in storage of known 'chalky' varieties is the proper approach, combined with the recommended attention to varietal purity.

Damaged and discoloured grain. Singly or in combination these quality characteristics have great bearing on paddy grade. It is not possible at this stage of quality standards determination to measure the extent of these combined faults by rapid non-manual means. Appropriate grade parameters can be set, however, and grade determined rapidly enough to enable inclusion in a paddy grading system.

Because relatively low levels of sample 'contamination' must be considered important as to 'grade', an acceptable method of manual determination has been developed.

Red rice. Red rice is not measurable by non-manual means in a field assessment. Depending on its prevalence and the degree of agronomic extension services, it may be considered quite unfair and unreasonable to incorporate this characteristic in grading paddy for local consumption. Red-streaked milled rice may not be regarded as a defect in the local market place. Therefore, unless paddy is purchased specifically for export markets, this characteristic need not be determined. Because export markets are in the main very particular in

respect to the incidence of red rice and red-streaked rice, its presence in a husked sample can be quantitatively determined manually (quite rapidly) to the extent of the grade limitations.

Foreign matter. This has been dealt with under 'Impurities'.

Brown rice and milling recovery. Brown rice recovery is not per se a characteristic requiring measurement. It is of course important to quality determination, but the reasons for high and low recovery are more important. Under standard conditions, brown rice recovery is varietal, as is milling recovery. Pure varieties have a virtually standard hull component (percentage) and a standard bran component (percentage). Attention has already been drawn to varietal purity in a system of standards and grades.

A grading system can accommodate the question of brown rice and milling recovery by its measurement of impurities, immaturity, and damaged/discoloured grains.

Head rice yields. Head rice yields can be determined objectively, as can brown rice and milling recovery (total white rice yield). It is a measure of grain quality of vital importance to the miller seeking to produce milled rice of superior or premium grades, as these inevitably demand low proportions of broken rice.

Head rice yields are strongly affected by the paddy drying regime, which is to a major degree outside the control of most regional producers at the present time. It is not, however, readily determinable in a paddy purchase/procurement situation and for this reason it is unrealistic to consider it as a grade factor. A further consideration is the relative importance placed by local consumers on the head rice content of the marketed product. Where there is scope in the market place for various grades of milled rice based on this factor, the problem can be managed by pricing, and standards for milled rice can be promulgated independently of the paddy grade. Where there is a strong involvement in the export trade, laboratory milling becomes virtually essential.

Milled Rice Grading

Standards for milled rice have been published by most rice-producing countries. The quality characteristics used are as follows:

- moisture content
- broken rice content
- damaged and discoloured kernels
- chalky kernels
- immature kernels
- paddy kernels
- rice of other classes
- red and red-streaked kernels

- foreign seeds
- foreign material (rice based and non-rice based)
- degree of milling.

Among the objectives of establishing standards and grades based upon such characteristics are the following:

- to ensure only edible rice reaches the consumer;
- to improve postharvest practices so as to eliminate or reduce waste;
- to improve agronomic practices to increase farm yields;
- to improve processing practices for better milling recoveries and for market expansion;
- to protect consumers from price/quality manipulation.

Again our standards must be reasonable and achievable, but there can be no compromise in relation to the first of the objectives just listed. No national standard can permit a grade of milled rice that could in any way endanger the health of the consumer. Hence, characteristics such as moisture content, foreign material, foreign seeds, and discoloured (particularly fermented) grains are important to this objective.

By setting standards for degree of milling, broken rice content, moisture, and discoloured kernels, we address the second objective. Better threshing and drying, and improved storage facilities, will emerge as important contributors to meeting the standard required.

The third objective provides incentive to the farmer; standards for chalkiness, rice of other classes, foreign seeds, immature kernels, and red rice are guidelines for the farmer and the agricultural scientist.

Millers have a vested interest in higher milling recovery and in market expansion. Standards for degree of milling and broken rice, paddy kernels, and foreign materials provide a measure of the miller's success in achieving this objective.

Finally, standards which clearly identify to the consumers the true value of their purchases surely provide the protection required against the possibility of unfair trading practices.

There I propose to leave the subject of milled rice grading. It presents fewer problems than paddy and I have already propounded the philosophy that the buyer will set the standards.

Concluding Remarks

Let me finally move to a few other considerations.

When we talk of maintenance of grain *quality* in storage we are also talking of the maintenance of grain *quantity* in storage, for surely safe storage implies both. Hence, we look to our storage systems to provide protection from both internal and

external influences, and these include birds, rodents, insects, microorganisms (moulds and bacteria), moisture, access of foreign contaminants including climatic elements, plus of course the development of objectionable odours and taste. Let me refer to some of these specifically.

Birds and Rodents

The level of depredation of stored grain by these animal pests is well known. Control is essentially effected by good warehouse design, and house-keeping with a variety of physical/mechanical aids. There are instances where chemical control is also used and it is stating the obvious to warn against the introduction of dangerous poisonous residuals into a grain storage area.

Insects

In the matter of control of insect pests, let me draw your attention to the projects of the ACIAR Grain Storage Research Program, which deal with the integrated use of pesticides in grain storage in the humid tropics (Projects 8309 and 8311). These projects are expected to provide systems for control of pests that should be acceptable both locally and in international trade. They are also providing an understanding of the influence of grain moisture and grain species on the biological activity and residual behaviour of pesticides used to protect stored grain. In particular, it is confidently expected that systems will be developed for the integrated use of pesticides that will reduce losses due to insect infestation during storage of high moisture content commodities in humid tropical environments.

Also, the ACIAR project entitled 'Long Term Storage of Grain Under Plastic Covers' (Project 8307) is clearly demonstrating that quality deterioration of grain during long-term storage in tropical areas can be vastly reduced and insect damage eliminated without the repeated use of chemicals. Controlled atmosphere storage with the use of carbon dioxide as a fumigant has been introduced on a large scale in Singapore, where 16 000 tonnes of bagged rice can be disinfested and held in a safe and stable condition for an extended period. In this situation, we have not only the maintenance of quality in storage, but an upgrading of the quality standard when insect-free output is compared with infested input.

Microorganisms

High moisture and temperature are the well-known environmental factors that bring about quality deterioration and quantity losses as a result of fungal and bacterial activity. These factors can be controlled by properly designed storages and drying systems. In-store drying of bulk paddy and aeration control, issues addressed by ACIAR

Projects 8308 and 8310, have proven a significant step forward in this regard.

Cleanliness and Sanitation

I have addressed a number of workshops in the region over the past five or six years, and I doubt that I have ever failed to raise the important matter of quality control and maintenance. We must strive to achieve and maintain clean storages. Just as there is no sense in drying waste material when we are supposed to be drying grain, we are wasting our time, money, and effort in our chemical insect control measures if we continue to neglect storage sanitation. This was an issue also raised during the March 1986 review of ACIAR's collaborative program of grain storage research, one of the reviewers, Professor E. Magallona of the University of the Philippines, stressing that storage sanitation is an issue that must be vigorously promoted in the region.

Finally, I want to say this:

Recent developments in the technology associated with the safe storage of grain under humid tropical conditions have given great hope to the grain producers, processors, and consumers in the region.

There is little doubt that a depressing gap had developed between the agriculturists and the postharvest technologists. The plant breeders gave us the Green Revolution with high-yielding varieties, but there was a major gap in the development and application of the postharvest needs of the burgeoning farm output.

I believe that the challenge has at last been met, and results are emerging which reflect great credit on the research teams involved. Let us make sure that we take all the necessary steps to see that the available technology is applied on a scale that will not only justify the Green Revolution, but will truly lift the standards of living of all the people of the region. This is the new challenge.

Technical Aspects of Postharvest Handling and Storage Session Chairman's Summary

B.R. Champ *

THIS seminar has been one of the first serious essays into providing an international forum for technologists, economists, and sociologists to debate issues relating to the introduction of new technology into the grains postharvest sector.

The first session on the technical aspects of handling and storage set the scene for the later discussions on the socioeconomic considerations that influence adoption of technologies. The session was intended to highlight major problem areas in the postharvest grains sector and to identify some of the technology that is available to solve these problems if, of course, the technology could be introduced effectively.

The speakers clearly identified real problems in the region, particularly those related to wet season harvests.

The first paper by Mr Loo on 'Collection of Grain from the Field' identified the technical constraints to safe caretaking of the grain in the vital period between harvest and delivery to some form of storage. The severe bottleneck that occurs in the wet season results in very serious deterioration of grain and it was evident from the discussion that this problem can be exacerbated by procurement and pricing policies which do not provide incentives to overcome it. Mr Loo suggested that for countries like Malaysia where labour costs are high, conversion to an efficient bulk-handling system would minimise losses, both quantitative and qualitative, and provide the lowest cost system to growers. Irrespective of this, it was clear from the various comments made by participants that there will continue to be serious losses until efficient procurement policies and incentives are put into place.

Dr Driscoll, in his paper on 'Grain Drying Strategies for the Humid Tropics' addressed the question of selection of the appropriate drying technology and how it could be implemented, particularly during the wet season harvests. The design and management of flat-bed batch dryers was considered in the context of providing an alternative to continuous-flow dryers in mill-level operations. Taking into account the limitations imposed by availability of drying facilities and the time constraint in drying very high moisture grain by flat-bed dryers, a flat-bed drying system was proposed based on primary drying carried out before the paddy was delivered into the procurement centre.

The final paper in this session, by Mr H. Baird, covered considerations of 'Grading and Maintaining Grain Quality in Storage'. This area was seen as pivotal to all other issues. Discussion centred on the factors that influenced grain quality and the role that grading plays in developing rational and profitable grain procurement policies. The inhibiting effects of inadequate facilities and practices were identified and criteria set down for placement of effective national paddy grading systems for each country based on quality characteristics appropriate to conditions in that country. Pressure

* ACIAR, G.P.O. Box 1571, Canberra, A.C.T. 2601, Australia.

for international standards was questioned for paddy but qualified support given for other commodities. With reference to maintaining quality after the grain had been taken into storage, particular attention was paid to storage hygiene and sanitation as critical elements in development of effective management strategies.

Specific recommendations have not been developed from this session. In the context of the seminar, any substantial follow-up activities should rightly be identified in the later sessions where the interactions of the technologists, economists, and sociologists have come under scrutiny, to see what improvements can be made to ensure that good technology is properly placed in the grain industries with benefits accruing to all.

**Economic Aspects of Postharvest
Handling and Storage —
Modelling**

Overview of Handling and Transportation of Grain

Won W. Koo *

Abstract

An efficient agricultural transportation system is important to producers and consumers. It is the vital link between the production and marketing of agricultural products. Prosperity in agriculture is dependent upon a transportation system that delivers agricultural products as cheaply as possible. Consumers rely on the transportation system to provide them with adequate supplies of food at low cost. Major innovative models used to improve the transportation system of agricultural products are examined in this paper. Transportation research is currently extensive, and numerous modelling efforts have been devoted to the analysis of these transportation issues. There have been several innovations in transportation modelling coupled with developments in computer technology, programming algorithms, and agricultural transportation data. Transportation models are generally categorised into interregional and intraregional models. This paper focuses on mathematical algorithms used in developing the models. The limitations of the models are also considered.

THE world economy tends to be more specialised based on the principle of comparative advantage in producing agricultural and non-agricultural products. This is especially true for agricultural commodities which require certain weather and soil conditions for production. As a result, an efficient transportation system plays an important role in shipping grains from producing regions to consuming regions. Producer prosperity in agriculture is highly dependent upon a transportation system that delivers agricultural products as economically as possible. Consumers also rely on the transportation system to provide them with adequate supplies of food at low cost. The ability of a country's agriculture to compete in foreign markets for agricultural products is also highly dependent upon the domestic and international transportation system. Thus, farmers, domestic consumers, and foreign buyers can all benefit from an efficient transportation system.

Demand for transportation services in shipping agricultural products has dramatically increased over the last several decades. Increased demand has been mainly contributed by interregional and international specialisation of agricultural products,

steady world population growth, and increases in the demand for food in developing countries.

Technological innovations in transportation services have been continuously introduced to meet an increasing demand for transportation services in shipping agricultural products either from farms to final destinations in a country or from exporting countries to importing countries. Major innovations include automated, large-volume, grain-handling facilities at ports and inland subterminals, large ocean vessels specialised for agricultural product shipments, and improvements in the inland transportation network (e.g. modernised highway and rail transportation systems).

Adjustments made by carriers, including the technical innovations to meet the increased demand for shipments of agricultural products, have not been sufficiently timely to avoid disequilibrium conditions in the transportation industry. The slow adjustments are due mainly to the greater uncertainty that the transportation industry faces in shipping agricultural commodities. Agricultural commodities, in general, display the following characteristics: (1) crop production depends largely upon weather and soil conditions, (2) most agricultural products are seasonal, and (3) agricultural products are perishable. These are major elements contributing to the uncertainty in

* Department of Agricultural Economics, North Dakota State University, Fargo, North Dakota 58105, USA.

marketing agricultural products. Slow adjustments can easily disrupt the normal operations of farmers, grain elevators, processors, merchandisers, feed manufacturers, livestock producers, and transportation firms, resulting in a domino effect all the way to the consumer. Its effects include price instability, inefficiency, and congestion in the grain-handling and transportation industry, high inflation stemming from the ultimate increases in food prices, and depressed farm income.

Evaluating transportation efficiency for grain shipments has generated volumes of studies on various aspects of it. Literature on the subject covers issues such as optimal subterminal location (Ladd and Lifferth 1975; Hilger et al. 1977), interregional commodity flows (Fedeler et al. 1975; Koo and Thompson 1982; Koo and Cramer 1980; Binkley and Shahman 1980; Leath and Blakely 1971), and the potential impacts of changes in ocean freight rates and trade restrictions on agricultural trade (Koo 1984; Barnett et al. 1982).

The objective of this paper is to examine the basic modelling techniques used to optimise transportation systems for agricultural products. Before examining the modelling technique, the theory of intermodal transportation systems will be briefly discussed. The basic modelling algorithm used to optimise grain-handling and transportation systems will then be examined.

Review of the Theory of Intermodal Transportation Systems

Modes of transportation used for grain shipments are rail, truck, and water modes. Based on the cost structure of these modes of transportation, the least-cost modes of transportation can be expressed as a function of distances travelled by each mode.

In Figure 1, hypothetical short-run average cost

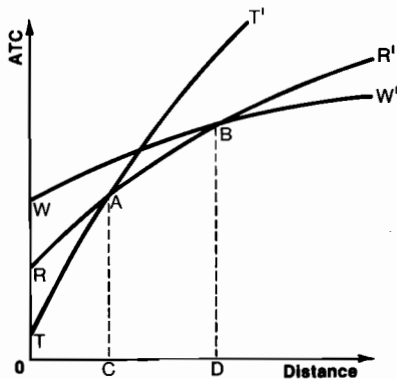

Fig. 1. Hypothetical average total cost curves for rail (RR'), truck (TT'), and water (WW') modes of transportation for a given origin and destination.

curves are constructed for rail, truck, and water modes according to distance between origin i and destination j . The hypothetical average total cost curve of trucking, depicted as TT' , shows that trucks have a comparative advantage for short hauls because they have relatively insignificant fixed and terminal cost components compared with other modes of transportation. Similarly, with respect to the cost structure of the water mode, the average total cost curve can be shown as WW' in Figure 1, since the water mode is generally recognised as the cheapest mode of transportation for bulk commodities over long distances. The cost structure for railways stands between truck and water modes. The shape of these curves also reflects the concept of 'rate taper', that is, the rates increase at decreasing rates as distance increases due to economies of long-haul. The cost curves, however, can be changed depending upon other factors, including volume, frequency of services, nature of terrain (uphill and downhill, or degree of curvature), and commodity characteristics, etc. In other words, the intercepts of the curves and their shape depend upon the cost factors stated above and these factors contribute to variations in freight rates, given the distance from one origin/destination pair to another. If the freight rate is solely determined by the cost of providing services, the transportation market will be divided between modes according to the hauling distance. The trucking industry will have a natural advantage in the OC market, railways in the CD market, and water if the distance is greater than OD. Intermodal competition is strong among modes of transportation to maintain and/or to expand their market share. Intramodal competition also exists in the regions served by several brands of the same mode (e.g. two railways). Since railways can easily penetrate the markets for other modes of transportation, railways by nature have an incentive to compete with other modes of transportation, by engaging in discriminatory pricing to penetrate markets where other modes have a comparative advantage. Where intra- and intermodal competition exists, railways may lower rates below their average costs while charging higher rates elsewhere.

Marketing systems for grain shipments depend largely upon the cost structure for transportation modes. The basic logistic system for grain shipments based on the transportation cost structure is shown in Figure 2. Trucks are mainly used to ship grain from farms to either elevators or subterminals and to domestic processors because they have a comparative advantage over other modes of transportation in this segment of the market where travel distance is relatively short. Grain is shipped from elevators either to final destination by trucks

Intraregional Models

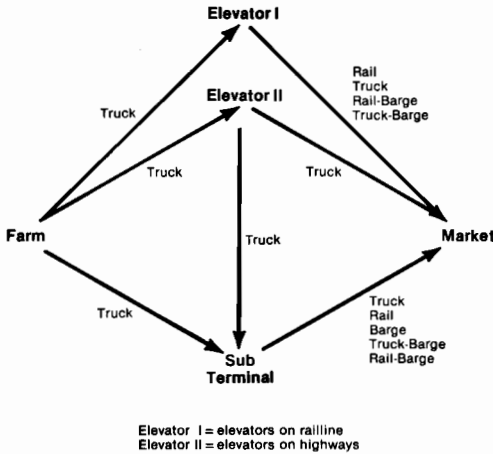

Fig. 2. Grain distribution system based on the transportation cost structure.

or rail, or to nearby subterminals by trucks. The quantities of grain received by subterminals are shipped to market by truck, rail, water modes, and/or combinations of these. Choice of transportation mode and route for shipments is mainly based on the cost structure shown in Figure 1 because the shipper's objective is to minimise transportation and handling costs in shipping a given amount of grain from a supply origin to market destinations.

Transportation Models

Two types of models have been developed to solve the agricultural transportation problems. The models are (1) stochastic behavioural models and (2) deterministic optimisation models. The stochastic behavioural model is used to examine and to understand pricing behaviour of transportation modes, such as rail, truck, and water mode, and competition among these modes. On the other hand, the deterministic optimisation model is used to improve the efficiency of the grain distribution system. This paper is focused mainly on alternative optimisation models that have been used to analyse problems of the U.S. agricultural transportation system. The deterministic optimisation models applied to transportation research are generally categorised into intraregional and interregional models. The intraregional model is designed to evaluate efficiency in physical distribution, competition, marketing structure, and capacity of a rural transportation system within a region, while the interregional model evaluates carrier capacity, handling and storage capacity, distribution, pricing, and competition among modes of transportation at national and international levels.

Price incentives given to large elevators enhanced the development of intraregional models to identify optimal location, size, and number of railcar-loading facilities in a region. Most of the intraregional models developed for this purpose are based on the Stollsteimer (1963) model. This optimises the number, location, and size of packing plants. Within a few years of its publication, others had applied his model to numerous plant location problems (King and Logan 1964; Polopolus 1965; Sanders and Fletcher 1966; Ladd and Halvorson 1970; Hicks and Badenkop 1971; Chern and Polopolus 1970).

Stollsteimer assumed that there are I sources of raw materials ($i = 1, 2, \dots, I$) and J possible plant sites ($j = 1, 2, \dots, J$). A plant site is a point where a plant may be located. The objective of the model was to determine the optimal number, location, and size of processing plants in a region. The plant location model, assuming that existing plants are to be ignored, minimises total transportation, investment, and processing costs as

$$TC = \sum_{j \in S_{km}} (\alpha + \beta \sum_{i=1}^I X_{ij}) + \sum_{i=1}^I t_{ij} \sum_{j \in S_{km}} \quad (1)$$

where TC = total transportation and investment costs

S_{km} = k -th set of m plant sites; number of all possible sets (k) is a combination of j ; $j = 1, 2, \dots, J$ in m possible plant sites; $k = j!/m!(j-m)!$

α = minimum average long-run cost of establishing and maintaining a plant

β = handling cost per unit at the processing plant

t_{ij} = transportation cost per unit from source i to processing plant j

X_{ij} = quantity shipped from source i to processing plant j .

This model can be solved by using a mixed-integer programming model with assignment of a 0 or 1 integer for plant j . Stollsteimer, however, used a heuristic approach and calculated minimum TC_j for all possible combinations of j with $m=1$, then $m=2$, then $m=3$, etc., until adding one more plant increases TC .

This plant location model was further extended to transshipment plant location problems to identify location, size, and number of plants which minimise costs of assembly, processing, and distribution. Numerous researchers (Hilger et al. 1977; Ladd and Lifferth 1975; Fuller et al. 1976) employed the transshipment models to determine optimal location, number, and size of a transshipment plant.

Each paper, however, used a different solution algorithm. A mixed-integer programming model was used by Hilger et al., a heuristic iterative approach by Ladd and Lifferth, and a network flow model by Fuller et al.

A heuristic iterative approach based on the Stollsteimer model was first employed by Tyrchneiwicz and Tosterud (1973) in their study of rail line abandonment in the Boissevain region of Canada. Their concern was not with the location of new facilities but with the impact of branch line abandonment on grain flows and handling costs. Their study was a one-period analysis with one grain for one final destination. This transshipment model was further developed by Ladd and Lifferth (1975). The Ladd and Lifferth study was based on monthly flows of two grains (corn and soybeans) to multidestinatons. The model does not minimise transportation, handling, and plant investment costs, but maximises total net revenue to producers (gross revenue minus transportation, handling, and plant-investment costs). Their concern was to optimise location, number, and size of subterminals in the Fort Dodge area of Iowa. This study employed two stages of transshipment while all previous studies included one stage. This type of model generally can include either quantity demanded at each destination or quantity supplied in each producing region. This model was also used by Baumel et al. (1973).

Mixed-integer programming algorithm based on Bender's decomposition (Bender 1962) is another method used in transshipment-plant location issues. This modelling technique was developed by Hilger et al. (1977). Their objective was to optimise location, number, and size of subterminals in Indiana. The specification of the model was the same as that by Ladd and Lifferth; monthly flows of grain to multidestinatons and employment of two stages of transshipment. Compared with the heuristic approach developed by Ladd and Lifferth, this algorithm can incorporate both quantity demanded at final destinations and quantities supplied in producing regions, whereas the heuristic approach can incorporate only one of these constraints. The objective function used in this modelling technique, however, should be linear, whereas the heuristic approach developed by Ladd and Lifferth does not require linearity in the objective function.

When supply and demand are fixed, a network algorithm can be used to identify optimal flows from producing regions to final destinations. A network model can be formulated with nodes and interconnecting arcs. Nodes represent elements comprising the system; arcs connect nodes. Each arc has a unit cost and capacity constraints. The

objective of the network algorithm is to find the least-cost route in travelling from one node to another. Hence, the network model is mathematically equivalent to linear programming in optimising flows of a commodity from one region to another.

Fuller et al. (1976) examined a cotton ginning industry in the Rio Grande Valley of Texas and New Mexico by using a network algorithm. The authors reported that the computer code developed for solving a minimum-cost-flow network problem is much faster than the available linear programming or mixed-integer programming codes. However, the network model cannot determine the optimal number, location, and size of subterminals. A network algorithm was also used to evaluate a rural road and bridge system in Iowa (Pautsch et al. 1985). Since demand and supply are fixed, the solution obtained from the network model is equivalent to the linear programming solution.

Interregional Model

Interregional studies are classified in terms of modelling into quadratic programming, linear programming, and network flows models. While the objective function and constraints are not necessarily linear in a quadratic programming model, linear programming and network flow models are based on an assumption that the objective function and constraints are linear. These interregional models are used to optimise freight flows, infrastructure, and modal choice, subject to the spatial equilibrium conditions. The spatial equilibrium of a single commodity with transportation costs is illustrated in Figure 3. The quantity of the commodity traded (QQ_t) is equal to the quantity exported (ef) and the quantity imported (gh) at the equilibrium price (OP_e). Inclusion of transportation costs, represented by a vertical distance ab , changes the spatial equilibrium conditions; increases the price in the consuming region from OP_e to OP_m and decreases the price in the producing region from OP_e to OP_x . Changes in the equilibrium prices of a commodity in consuming and producing regions can be expressed as a function of transportation costs as follows (Kreinin 1979):

$$P_e P_m = \frac{e_x}{|e_m| + e_x} ab \quad (2)$$

$$e_e P_x = \frac{|e_m|}{|e_m| + e_x} ab \quad (3)$$

where e_x is the price elasticity of excess supply and e_m is the price elasticity of excess demand of the commodity. When several consuming and producing regions are included in trading more than

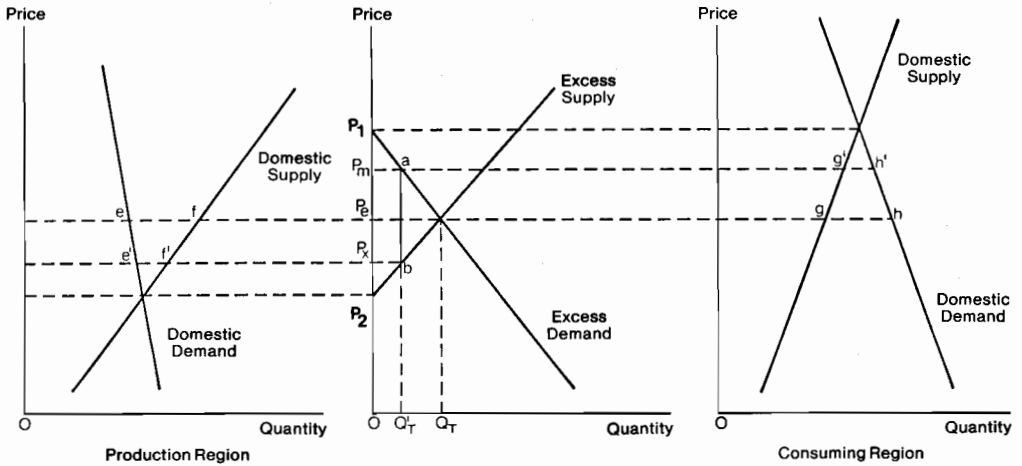

Fig. 3. Two regions trade model when transportation costs apply.

one commodity, the effects of transportation costs on the spatial equilibrium condition cannot be obtained from Equations 2 and 3. The reason for this is that the equilibrium price in a consuming region is influenced by transportation costs from all producing regions to the consuming region. Similarly, the equilibrium price in a producing region is influenced by transportation costs to all consuming regions from the producing region.

A quadratic programming model has been used to solve large-scale spatial equilibrium problems. Assuming linear supply and demand functions, the spatial equilibrium model was formulated in a quadratic programming algorithm by Takayama and Judge (1964). The objective function used in the model was to maximise the net social payoff function defined by Samuelson (1952). The objective function is calculated by integrating excess demand ($D_i = \alpha_{oi} - \alpha_{li} P_i$) for the i^{th} consuming region, and supply functions $S_j = \beta_{oj} + \beta_{lj} P_j$ for the j^{th} producing region with respect to prices as follows:

$$W = \sum_{i=1}^n \int (\alpha_{oi} - \alpha_{li} P_i)^d P_i + \sum_{j=1}^n \int (\beta_{oj} + \beta_{lj} P_j)^d P_j - \sum_{i=1}^n \sum_{j=1}^n t_{ij} X_{ij} \quad (4)$$

where W is the net social payoff, P_i is price in consuming region i , P_j is price in producing region j , t_{ij} is transportation costs in shipping a commodity from producing region j to consuming region i , and X_{ij} is the quantity shipped from producing region j to consuming region i . This objective function is quadratic in terms of the prices in producing and consuming regions.

To accomplish a spatial equilibrium condition among these regions, the objective function was maximised subject to the following constraints:

$$\alpha_{li} P_i + \sum_{j=1}^n X_{ij} = \alpha_{oi} \quad i = 1, 2, \dots, n \quad (5)$$

$$-\beta_{lj} P_j + \sum_{i=1}^n X_{ij} = \beta_{oj} \quad j = 1, 2, \dots, n \quad (6)$$

$$P_i - P_j \geq t_{ij} \quad (7)$$

where $\sum_{j=1}^n X_{ij}$ represents the quantity demanded by consuming region i , and $\sum_{i=1}^n X_{ij}$ represents the

quantity supplied by producing region j . Equations 5, 6, and 7 satisfy the spatial equilibrium condition shown in Figure 3. Equation 7 also satisfies the Kuhn and Tucker condition for optimisation (Kuhn and Tucker 1951).

Koo (1984) and Koo and Uhm (1986) developed a quadratic programming model similar to that of Takayama and Judge. The objective function of the model was to maximise the net social payoff function associated with producers in the United States and consumers in foreign importing countries. Domestic transportation activities were used to connect producing regions to domestic consuming regions and export ports, and ocean transportation activities were used to connect export ports to foreign importing regions. This study did not allow carryover stocks at each port. A different type of quadratic programming algorithm was also developed for large-scale spatial equilibrium problems (Plessner and Heady 1965; Meister et al.

1978). Because these models treated production activities as variable, only regional demand functions were specified rather than specifying demand and supply functions. The purpose of these models was to optimise grain livestock production activities in the United States.

Unlike quadratic programming models, linear programming models assume that the objective function and constraints are linear. This indicates that, in the context of spatial equilibrium, quantities of a commodity demanded in consuming regions and those supplied in producing regions are fixed rather than price dependent.

A typical linear programming model used in transportation research is expressed as

minimise

$$Z = \sum_{i=1}^n \sum_{j=1}^n C_{ij} X_{ij} \quad (8)$$

subject to

$$\sum_{j=1}^n X_{ij} \leq S_i \quad i = 1, 2, 3, \dots, n \quad (9)$$

$$\sum_{i=1}^m X_{ij} \geq D_j \quad j = 1, 2, 3, \dots, m \quad (10)$$

$$X_{ij} \geq 0 \quad (11)$$

where C_{ij} = unit transportation cost of shipping a commodity from the i^{th} producing region to the j^{th} consuming region

X_{ij} = quantity of commodity shipped from the i^{th} producing region to the j^{th} consuming region

S_i = quantity of commodity supplied in the i^{th} producing region

D_j = quantity of commodity demanded in the j^{th} consuming region.

The model simply determines flows of commodities from supply regions to consuming regions on the basis of an objective function which minimises the total transportation costs. Since the model has demand and supply constraints in each consuming and producing region, respectively, it satisfies the spatial equilibrium condition in the study area.

The model is simple to use and very efficient in terms of computer operation. Theoretically, it does not have any limitation in size and complexity. Consequently, it has a great advantage in formulating a large-scale model with great detail. The limitation of the model in solving spatial equilibrium problems is the assumption of fixed demand and supply. It cannot recognise the price response of supply and demand in each region.

Hence, the solution obtained from the model cannot be viewed as a global optimal solution, but a conditional optimal solution under predetermined demand and supply conditions.

Another advantage of this linear programming model over a quadratic programming model in transportation research is that the net effects of changes in transportation activities can be found, since quantities demanded and supplied are fixed in a linear programming model whereas it is difficult in a quadratic programming model. Numerous grain transportation studies have been conducted on the basis of linear programming models (e.g., Leath and Blakely 1971; Fedeler et al. 1975; Binkley and Shahman 1980; Koo and Cramer 1980).

More recently, a network flow algorithm was developed by Ali et al. (1984) to solve the linear programming transportation model. Their network flow algorithm, unlike previously developed network models, recognises more than one commodity and is two to three times faster than the general linear programming simplex algorithm. The network flow algorithm was applied to the U.S. grain transportation system by Barnett et al. (1982). The aim was to evaluate U.S. port capacity in exporting grains. Consequently, the model treated quantities of grain handled at each U.S. port as endogenous variables. Port capacity was evaluated on the basis of shadow prices estimated from the model. Multiproduct network flow models may be superior to simple linear programming models in terms of computational efficiency. However, the multiproduct network model can optimise only the flow of commodities from producing regions to consuming regions. A model including production and transportation activities to optimise product location of commodities and their flows cannot be accomplished efficiently by using the multiproduct network flow algorithm.

Concluding Remarks

As has been outlined, many different mathematical models have been developed to analyse transportation issues. Choice of model depends upon the transportation issues to be analysed and the objectives of the study. Development of better models has been accomplished with innovations in computer technology and programming algorithms, and availability of greater amounts of data on agricultural transportation. These developments have contributed to improved transportation research. However, further development is needed in modelling activities to address emerging issues in transportation in a rapidly changing environment.

Acknowledgment

The author thanks Delmer L. Helgeson for helpful comments on the draft manuscript of this paper.

References

- Ali, I., Barnett, D., Farhangian, K., Kennington, J., McCarl, B., Patty, B., Shetty, B., and Wong, P. 1984. Multicommodity network problems: applications and computations. *Institute of Industrial Engineers Transactions*, 16, 127-134.
- Barnett, D., Binkley, J., McCarl, B., Thompson, R., and Kennington, J. 1982. The effects of U.S. port constraints on national and world grain shipments. Lafayette, Indiana, Purdue University, Bulletin No. 399.
- Baumel, C.P., Drinka, T.P., Lifferth, D.R., and Miller, J.P. 1973. An economic analysis of alternative grain transportation systems: a case study. Springfield, Virginia, National Technical Information Service, Report No. PB 224319.
- Bender, J.F. 1962. Partitioning procedures for solving mixed-variables programming problems. *Numerische Mathematik*, 4, 238-252.
- Binkley, J.K., and Shahman, L. 1980. Implications of recent user charge legislation for barge transportation of agricultural commodities. *Southern Journal of Agricultural Economics*, 23, 117-123.
- Chern, Wen-Shyong, and Polopolus, L. 1970. Discontinuous plant cost functions and a modification of the Stollsteimer location model. *American Journal of Agricultural Economics*, 52, 581-586.
- Fedeler, J., Heady, E., and Koo, W. 1975. An interregional analysis of U.S. domestic grain transportation. Ames, Iowa, Iowa State University, CARD Report No. 54T.
- Fuller, S.W., Randolph, P., and Klingman, D. 1976. Optimising subindustry marketing organisations: a network analysis approach. *American Journal of Agricultural Economics*, 58, 425-436.
- Hicks, B.G., and Badenhop, M.B. 1971. Optimum number, size, and location of livestock auction markets in Tennessee. Nashville, Tennessee, Tennessee Agriculture Experiment Station, Bulletin 478.
- Hilger, D.A., McCarl, B., and Uhrig, J. 1977. Facilities location: the case of grain subterminals. *American Journal of Agricultural Economics*, 59, 674-682.
- King, G.A., and Logan, S.H. 1964. Optimum location, number and size of processing plants with raw product and final product shipments. *Journal of Farm Economics*, 46, 94-108.
- Koo, Won W. 1984. Economic effects of trade restrictions and transportation costs on the U.S. wheat exports. *North Central Journal of Agricultural Economics*, 6, 99-107.
- Koo, Won W., and Cramer, G. 1980. An econometric analysis of the U.S. wheat marketing structure. Bozeman, Montana, Montana State University Agricultural Experiment Station, Bulletin No. 722.
- Koo, Won W., and Uhm, I.H. 1986. Spatial equilibrium analysis of U.S. wheat trade. *The Logistic and Transportation Review*, 22, 27-29.
- Koo, Won W., and Thompson, S. 1982. An economic analysis of U.S. grain marketing and transportation systems. Fargo, North Dakota, North Dakota State University Agriculture Experiment Station, Report No. 89.
- Kreinin, M.E. 1979. *International economics: a policy approach* (3rd ed.). New York, Harcourt Brace Jovanovich.
- Kuhn, H.W., and Tucker, A.W. 1951. Nonlinear programming. In: Nezman, J., ed., *Proceedings of the second Berkley symposium on mathematical statistics and probability*. Berkley, California, University of California Press.
- Ladd, G.W., and Halvorson, M.P. 1970. Parametric solutions to the Stollsteimer model. *American Journal of Agricultural Economics*, 52, 575-580.
- Ladd, G.W., and Lifferth, D.R. 1975. An analysis of alternative grain distribution systems. *American Journal of Agricultural Economics*, 57, 420-430.
- Leath, M.N., and Blakely, L. 1971. An interregional analysis of the U.S. grain marketing industry 1966/67. Washington, D.C., U.S. Department of Agriculture Economic Research Service, Technical Bulletin 1444.
- Meister, A.D., Chen, C.C., and Heady, E.O. 1978. Quadratic programming models applied to agricultural policies. Ames, Iowa, Iowa State University Press.
- Pautsch, G.A., Hamlett, C., and Baumel, C. 1985. An examination of a rural road and bridge system: a network flow model. In: Koo, W.W., and Larson, D., ed., *Transportation models for agricultural products*. Boulder/London, Westview Press, 81-104.
- Plessner, Y., and Heady, E.O. 1965. Competitive equilibrium solutions with quadratic programming. *Metroeconomica*, 17, 117-130.
- Polopolus, L. 1965. Optimum plant numbers and locations for multiple product processing. *Journal of Farm Economics*, 47, 287-295.
- Samuelson, P. 1952. Spatial price equilibrium and linear programming. *American Economics Review*, 42, 283-303.
- Sanders, B., and Fletcher, L.B. 1966. Least-cost egg marketing organisation under alternative production patterns. Ames, Iowa, Iowa State University Agriculture and Home Economics Experiment Station, Bulletin 547.
- Stollsteimer, J.F. 1963. A working model for plant numbers and locations. *Journal of Farm Economics*, 45, 631-646.
- Takayama, T., and Judge, G.G. 1964. Spatial equilibrium and quadratic programming. *Journal of Farm Economics*, 46, 67-93.
- Tyrchniewicz, E.W., and Tosterud, R.J. 1973. A model for rationalising the Canadian grain transportation and handling system on a regional basis. *American Journal of Agricultural Economics*, 55, 805-813.

Optimisation Techniques for the Economic Analysis of the Postharvest Handling and Storage of Grains

T.G. MacAulay *

Abstract

Optimisation techniques and systems analysis are standard techniques within the kit-bag of applied economists. However, many difficulties are involved in the practical application of these techniques to the analysis of real problems. In this paper, an outline of some of these techniques is provided, with emphasis given to their application and their suitability for the analysis of various problems in the postharvest handling of grains. The techniques reviewed are various forms of linear programming, transportation models, and spatial equilibrium type models.

MANY of the problems concerning the postharvest handling of grains, whether in the humid tropics or elsewhere, involve transformations of products from one form to another, for example, wet rice to dry rice, transportation from one site to another, and the holding in storage from one time period to another. Each of these transformations involves a cost, so as to gain an expected return. These costs may be borne by government or a private firm or an individual. Also, it is reasonable to expect losses to occur and for other inputs such as labour, energy, and packing to be added to form the final product. Modelling systems designed to permit analysis of the postharvest problems of grains would seem to need to be able to incorporate at least these features of the grain-handling system if they are to be useful. For any given problem, all of these features may not be equally important since they will vary in significance according to the nature of the questions being asked. However, in principle the applied economist's kit-bag should have tools which are capable of permitting these elements to be included.

Linear programming and various other associated optimisation techniques have been used to solve a very great variety of real world problems. In this

paper, attention will be focused on its use in various forms in terms of the transformation of grains through time, space, and form. However, there are a number of other broad approaches to modelling the transformation of agricultural commodities through time, space, and form. These include optimal control methods, econometric 'what if' policy models, and various types of stochastic simulation models. Consideration will not be given to these. Emphasis in the paper will be placed on the spatial equilibrium type models since at a practical level these seem to offer a high degree of generality and would appear to be suitable for a wide variety of situations where time, space, and form transformations are involved. In addition, recent work indicates that algorithms are available to solve very large versions of the spatial equilibrium model and that they can be solved using linear programming rather than quadratic programming as is generally indicated in the literature. This result should mean that spatial equilibrium models can be more widely applied and more easily understood. In addition, such mathematical programming models can be constructed and solved with very large numbers of regions and/or supply and demand points. This feature makes them attractive for networks in which time, space, and form transformations are involved, since the study of such transformations inevitably involves many nodes.

* Department of Agricultural Economics and Business Management, University of New England, Armidale, N.S.W., Australia, 2351.

Time, Space, and Form Transformations

Bressler and King (1970) demonstrated that there is a clear set of parallels between choices made between time periods, between forms of a product, and between locations in competitive markets. Takayama and Judge (1971) have also illustrated these parallels, particularly in the case of time and space. The approach of these authors has been to consider time and space in particular, as measured at a given point rather than being continuous.

The simplest case of transformation is that of the shipment of goods between distinct locations which involves the input of transport services for which there is a fixed per unit cost. Thus, if the demand price in region 1 is p_1 and the supply price in region 2 is p^2 (notation is that of Takayama and Judge 1971), then the spatial trading condition for a competitive trading system is that:

$$p_1 - p^2 \leq t_{21} \quad (1)$$

where t_{21} is the cost per unit of distance for transferring one unit of a good from region 2 to region 1. This relationship is simpler than the time and form transformations, since in shipping a good from source to destination losses are usually negligible and time discounting is not appropriate for the same time period. However, if losses (or gains) occurred during shipping then the coefficient on p^2 could no longer be assumed to be 1.0. Further, if a considerable period of time was involved in the shipment then time discounting would be appropriate. The arbitrage condition (2) can be further modified to take account of different exchange rates, tariffs, and transfer costs that vary with the volume of goods shipped. The inequality sign is used since the possibility exists that goods will not be transferred and in this case the prices may differ less than the transfer cost. It is worth noting at this stage that the economics of space may be viewed in two quite distinct ways: first, as a continuum over a landscape, and second, as a series of points at which economic activity is focused. The continuous approach to space has a long history deriving from the early work of Weber (1909) and leading to the development of the generalised Weber problem solved, for example, by Cooper (1963) and Tapiero (1971). The work of von Oppen and Scott (1976) represents an attempt to combine both approaches. Location economics, deriving from the field of geography and regional science, has tended to treat space as continuous, while the international trade theorists have tended to view space as consisting of a set of discrete points. It is this latter approach which is of concern in this paper.

In the case of storage (transformation through time) the relationship is very similar in character to that of space. In a competitive system the price of

the good stored for one period will be the price in the first period plus the cost of storage or time transfer cost. In addition, the complication of the time preference for money must be introduced. This involves the use of a discount factor. The relationship may be written as:

$$\sigma p(t+1) - p(t) \leq \sigma b(t, t+1) \quad (2)$$

where σ is the discount factor $1/(1+r)$ and r is the discount rate, $p(t)$ is the price of the product prior to storage, with $p(t+1)$ the price after one period with the cost of storage from period t to $t+1$ being $b(t, t+1)$. Losses may be involved both in terms of quality and quantity. If there are losses in quality, this implies a higher cost of storage than would otherwise be the case and losses in quantity may be accounted for in terms of a loss coefficient on the first term of equation (2).

In the case of different forms of product (MacAulay 1976, pp. 172-6) the final product price, ${}_1p$, will be related to the raw materials price, ${}_2p$, as follows (subscripts before the letters indicate the product form):

$${}_1p - {}_{12}a {}_2p \leq {}_{12}m \quad (3)$$

where ${}_{12}a$ is the number of units of final product obtained per unit of raw material and ${}_{12}m$ is the cost per unit of final product to transform the raw material into the final product (this includes the costs of other inputs used to make the transformation possible). The raw material may be used for a number of products (for example, cattle providing meat and other by-products), or a number of raw materials used for a given product (for example, the production of bread using flour, water, sugar, oil, yeast). In both cases (or even the combined case) value-added equations similar to the above may be derived. In effect, the form transformation involves derived demand relationships. In the case of a fixed input-output type of production system, in which a given final product is produced from many inputs in fixed proportions, the relationship may be specified as follows (Takayama and Judge 1971, pp. 280-1):

$${}_1p - ({}_{12}a {}_2p + {}_{13}a {}_3p + \dots + {}_{1n}a {}_n p) \leq m \quad (4)$$

where m is now the cost of purchased inputs used in the production of the final product not directly included in the input-output type production system. Again, the inequality is used so that the case in which no transformation takes place is permitted and in this case the final product price may be less than the weighted cost of the inputs plus purchased inputs included in m . Note that the a_{ij} coefficient may include losses in physical quantities that occur, while m may include the cost of losses in quality.

The similarity of the relationships linking transformations in time, space, and form is now

obvious. In effect, the price of a good in a competitive trading system will be less than or equal to the price of the good or goods from which it is transformed plus the cost of transformation. Not only are there connections between prices in such trading systems but there are also connections between the quantities. These relationships are more obvious and relate to the fact that more cannot be consumed than is supplied and that in a fixed input-output production system the weighted sum of the inputs must at least equal the quantity of the final output.

Relationships Between Transformation Models

Numerous types of models have been used to reflect the economic decisions involved in time, space, and form transformations. In subsequent sections of this paper, a characterisation of some of these models will be attempted. An overview of the relationships between some of these models and their solution methods is given in Table 1.

Network Models

Network models represent the simplest form of this set of models. The typical network models are those designed to solve the shortest-route problem, the minimal spanning-tree problem, the maximal flow problem, and those related to the critical path method (CPM) and the program evaluation and review technique (PERT) (Lee et al. 1985). These methods all have specialised solution algorithms that make possible the solution of large and complex networks. Examples of these models are the work of Fuller et al. (1976) and Monterosso et al. (1985). In the case of Fuller et al. a network approach was used to solve an integer programming problem which was well beyond the capacity of commercial

integer programming packages to solve. The appeal of network methods is in their simplicity in terms of conception and the ease with which they can be explained to management.

In terms of the problems of the postharvest handling of grain, these network models might be used for examining the questions of vehicle flow over a network of roads or a rail system, maximum possible throughputs of drying systems, project planning or construction planning for grain terminals, or other projects including events with critical timing for completion.

Transportation-Allocation Models

The transportation-allocation models represent a large and diverse group of models which can be solved using linear programming but more specialised algorithms are often more efficient. Some of these models relate quite closely to the network models, while others are much more concerned with the allocation of resources to produce a series of products. This group of models can be characterised by the fact that they tend to be built with the assumption of fixed supply and demand quantities implying a given set of prices. The transportation-type models in which a given set of supplies must be shipped at minimum cost to meet a given set of demands will be used as illustrative of this group.

The general form of the transportation model is as follows:

$$\text{Minimise } \sum_{ij} c_{ij} x_{ij}, \quad (5)$$

$$\text{Subject to } \sum_j x_{ij} = D_i \quad (i = 1, 2, \dots, m), \quad (6)$$

$$\sum_i x_{ij} = S_j \quad (j = 1, 2, \dots, n), \quad (7)$$

$$x_{ij} \geq 0, \quad (8)$$

where x_{ij} are the quantities shipped from region i to region j , c_{ij} are the costs of shipment between the

TABLE 1. A classification of transformation type models.

Use	Basic algorithm			
	Network methods	Linear programming ^a	Integer programming	Quadratic programming
Flow analysis	Network models			
Resource allocation — fixed prices and quantities		Transportation-allocation		
Plant location decision			Location-allocation	
Price effects				Spatial equilibrium

^aIncludes specialised algorithms which are based on linear programming.

two points i and j , D_i is the quantity demanded at location i , and S_j is the supply available at location j . The standard solution procedure for this problem is known as the MODI method or modified distribution method (Lee et al. 1985). It has also been shown that the usual sensitivity analysis of linear programming can be obtained for transportation-type models (Toft et al. 1970).

An important extension to the transportation model is to allow for the transshipment of goods so that every source and destination can also be an intermediate point on the path of shipment from a source to a destination (Hurt and Tramel 1965; Toft and Cassidy 1986). In simple terms this involves expanding the size of the matrix so that sources and destinations can have both inflows and outflows. For example, the standard 3×3 problem becomes a 6×6 problem (Tables 2 and 3). In Table 3 a set of transportation costs and processing costs is

provided, along with the fixed demand and supply quantities. Off the diagonal of matrix A , the transportation costs for the raw product are provided. For example, the cost of shipping from region 1 to region 2 is given as \$9. The processing cost of one unit of the raw material to the final product in a plant located in region 1 is given as \$5 (these processing costs might also be thought of as storage costs). Similarly, the transportation costs for the final product are given in matrix D for which there are no processing costs (zero down the diagonal). The matrix C is what Toft and Cassidy (1986) termed the 'pivotal matrix' since it performs the function of ensuring that quantities of final product produced at each plant are made available to the rows (supply) of matrix D for shipment between the regions. It has zero costs down the diagonal and very high costs off the diagonal. The top part of the S_i column contains the supplies of

TABLE 2. Illustration of a three-region transshipment problem with limited plant processing capacity^a.

	Processing Plants			Consuming Regions			S_i
	1	2	3	1	2	3	
Production regions	A			B			
1							Raw product supply
2		Raw product shipments			Not used		
3							
Processing plants	C			D			
1							Processing capacity
2		Excess capacity ('pivotal matrix')			Final product shipment		
3							
r_j	Processing capacity			Final product demands			

^aIn the solution, matrix A contains the amounts shipped of the raw material, matrix C contains the excess capacity in the processing plants, and matrix D contains the amounts shipped of the processed product. This formulation represents that used by Hurt and Tramel (1965).

TABLE 3. Illustrative cost data for a transshipment model.

	Processing Plants			Consuming Regions			S_i
	1	2	3	1	2	3	
Production regions	A			B			
1	5	9	11	*	*	*	15
2	7	7	12	*	*	*	8
3	8	11	8	*	*	*	5
Processing plants	C			D			
1	0	*	*	0	1	2	30
2	*	0	*	1	0	3	30
3	*	*	0	2	3	0	30
r_j	30	30	30	7	14	7	

Source: Toft and Cassidy (1986).

raw material available to each of the regions and the second part of the column contains a number at least as great as the total quantity available for processing. The assumption in this case is that any of the three plants could process up to 30 units of the raw material (these plant capacities could be made limiting). The last part of the r_j row contains the demand quantities for the final product and the first part contains the plant processing capacities. These quantities must balance, with the implication that both the raw material and the final product must be measured in the same units. The minimum cost solution to this problem is provided in Table 4. In this particular solution, none of the raw materials is shipped between regions. A total of 15 units is processed in region 1, 8 units in region 2, and 5 units in region 3 (matrix A). The diagonal of Matrix C in Table 4 contains the unused plant capacities given that the capacities were set at 30 for each plant. Matrix D contains the shipments of final product with 7 units being shipped from the processing plant in region 1 to meet demand in region 1, 6 units shipped from region 1 to region 2, and 2 units shipped from region 1 to region 3 to meet the total demand of 15 units. The total cost of this solution is \$157.

King and Logan (1964), in considering the location of cattle slaughtering plants, introduced the idea of economies of scale in processing costs. Leath and Martin (1967) showed how the transshipment model could be used for problems involving time. Their analysis involved a multi-factor, multi-product, and multi-plant problem. Toft and Cassidy (1986) have developed the method of the 'pivotal submatrix' as a means of generalising the various formulations of Hurt and Tramel (1965) and the work of Leath and Martin (1966) in including inequality constraints. Toft and Cassidy (1986) have also shown that the pivotal matrix provides a

convenient means of including increasing or decreasing marginal costs of processing. In the case of decreasing marginal costs a search procedure is involved since a unique optimum is not necessarily determined.

The transportation problem with all its various modifications for time, space, and form transformations is a most useful and practical method of examining some of the problems of postharvest handling of grains when it is safe to assume that the changes to the system being examined will have little or no effect on market prices and therefore on the quantities consumed or supplied. It opens up a way to analyse the impacts of system changes at numerous nodes. Toft and Cassidy (1985, p. 19) report the results of analysis with '... 59 supply areas, overseas demand at shipping ports, demand by local wool processors at 15 locations, and price stabilising stockpiling by the Australian Wool Corporation.' Their total matrix size was 90×73 . The computer code to run such problems is readily available, even for smaller-scale problems on microcomputers. [Bunday (1984) includes a BASIC program; Lee and Shim (1986) an IBM PC diskette for a 40×40 problem.] Very large problems could be solved on more recent microcomputers with memory capacities of over one megabyte. One of the strongest arguments for the use of transportation-type models is their simplicity and minimal requirements for data.

In terms of grain handling, some of the many issues that might be examined include: (1) the location and number of drying and storage facilities; (2) the minimum cost volumes through a network of plants; (3) the effects of changing processing and transportation costs; (4) changes to storage policies (particularly through the use of new technology); and (5) the effects of changing supply and demand patterns at different locations. When constructed as

TABLE 4. Minimum cost solution for transportation model.

	Processing Plants			Consuming Regions			S_i
	1	2	3	1	2	3	
Production regions	A			B			
1	15	0	0	0	0	0	15
2	0	8	0	0	0	0	8
3	0	0	5	0	0	0	5
Processing plants	C			D			
1	15	0	0	7	6	2	30
2	0	22	0	0	8	0	30
3	0	0	25	0	0	5	30
r_j	30	30	30	7	14	7	

Source: Toft and Cassidy (1986).

a multi-period model the effects of variability in supplies and demands on storage capacity can be assessed.

Location-Allocation Models

The location-allocation problem is designed to deal with the trade-off between the cost of operating a plant or a storage facility and the costs of shipment. A system might be constructed in which there are few processing or storage facilities and high transportation costs or many processing and storage facilities and lower transportation costs. The key question answered by such analyses is how many processing facilities to use when start-up and possibly shut-down fixed costs are involved.

The location-allocation problem can be handled by using integer programming or zero-one programming [for example, Faminow and Sarhan (1983) included 45 supply regions, 52 demand regions and 50 slaughtering and processing plant sites]. Although sophisticated integer programming computer codes are available, large-scale problems are still time consuming to solve. Thus, in practical terms the use of integer programming is somewhat limited for moderate to large problems. However, recent work on the use of what is known as Benders' decomposition [Geoffrion and Graves (1974): 11 854 rows, 727 zero-one variables, and 23 513 continuous variables; Hilger, McCarl and Uhrig (1977): 3588 constraints, 31 656 continuous variables, and 19 zero-one variables] and network solution procedures [Fuller et al. (1976): 139 production locations, 14 processing plants and 16 production weeks; Monterosso et al. (1985)] have been reasonably successful.

An alternative approach to the solution of this type of problem is that of Stollsteimer (1963) who used a heuristic approach by first minimising a transfer cost function with respect to plant location numbers and locations to obtain an assembly cost function and then for a given quantity of raw material found the minimum cost of processing as the number of plants was varied. The minimum cost system was then found by combining the assembly cost function and the total processing cost function for varying numbers of plants. Examples of the use of this approach in relation to grain systems are given by Ladd and Lifferth (1975) and Tyrchniewicz and Tosterud (1973).

The standard location-allocation problem involves the choice of an activity when there is a fixed cost or start-up charge involved with each plant. In the case where one production plant per region is to be built or not (that is, a supply point chosen) then the problem may be represented as follows (Ellwein and Gray 1971):

$$\text{Minimise } Z = \sum_{ij} c_{ij}x_{ij} + \sum_i F_i y_i, \quad (9)$$

$$\text{Subject to } \sum_j x_{ij} \leq K_i y_i \quad (i = 1, 2, \dots, m), \quad (10)$$

$$\sum_i x_{ij} \geq D_j \quad (j = 1, 2, \dots, n), \quad (11)$$

$$x_{ij} \geq 0 \text{ and } y_i \in (0,1). \quad (12)$$

where c_{ij} is the transportation cost per unit of product, x_{ij} the quantity of product shipped between locations i and j , F_i is the total fixed cost including amortised construction costs and operating costs of plant i , y_i is a zero or one variable indicating whether or not the plant is selected, K_i is the production capacity of plant i , and D_j is the quantity of product demanded in region j .

This model closely parallels that of the multi-product transshipment model discussed in the previous section, except that the production centre and processing plant are at the same location and fixed costs have been included. The model can obviously be extended in most of the ways illustrated above.

An extension to this form of model is that by Geoffrion and Graves (1974, p. 823) which has the following form:

$$\text{Minimise } Z = \sum_{imjk} c_{imjk} x_{imjk} + \sum_k \left\{ F_k z_k + v_k \sum_{mj} D_{mj} y_{jk} \right\}, \quad (13)$$

$$\text{Subject to } \sum_{jk} x_{imjk} \leq S_{mi} \text{ for all } m \text{ and } i \text{ (supply balance),} \quad (14)$$

$$\sum_i x_{imjk} \geq D_{mj} y_{jk} \text{ for all } m, j, \text{ and } k \text{ (flow or not to demand),} \quad (15)$$

$$\sum_k y_{jk} = 1 \text{ for all } j \text{ (warehouse to one demand region only),} \quad (16)$$

$$L_k z_k \leq \sum_{mj} D_{mj} y_{jk} \leq U_k z_k \text{ for all } k \text{ (warehouse capacity bounds),} \quad (17)$$

$$\text{Linear configuration constraints on } y_{jk} \text{ and/or } z_k, \quad (18)$$

$$x_{imjk} \geq 0, y_{jk} \in (0,1) \text{ and } z_k \in (0,1), \quad (19)$$

where

c_{imjk} is the cost of transporting one unit of commodity m from plant i through warehouse k to demand region j ,

x_{imjk} is the quantity shipped of commodity m from plant i through warehouse k to demand region j ,

F_k is the fixed charge of opening and operating warehouse k ,

v_k is the per unit charge of shipping through warehouse k ,

y_{jk} is one if warehouse k serves demand region j or zero otherwise,

z_k is one if warehouse k is open or zero otherwise,

S_{mi} is the fixed supply of commodity m at plant i , and

D_{mj} is the fixed demand for commodity m in region j .

Note that the index m refers to commodities, i to plants or supply, k to warehouses, and j to demand regions.

The first term in the objective function represents the transportation costs, while the second term represents the fixed costs of opening a warehouse. The third term is the warehousing cost of the volume actually shipped to meet customer demand for each of the products. Since the warehouses can store multiple products, it is necessary to separate the fixed cost element from the variable cost component. The first and second constraints (14) and (15) are the standard supply and demand balance constraints. The third constraint (16) forces the condition that only one warehouse can supply a given demand region. Geoffrion and Graves argue that this is a common practice in the business world for efficiency reasons. Imposing this constraint on the model adds greatly to the efficiency of solution when using Benders' decomposition. Benders' decomposition is a means of decomposing the problem into two parts and exploits the dual problem to obtain a solution (Hilger et al. 1977). The fourth constraint (17) provides a set of upper and lower capacity bounds for any warehouse that is open. If the warehouse is not open, the bounds do not apply. This set of bounds can also provide the means for a piecewise-linear approximation to warehousing cost functions. The fifth set of constraints (18) is indicated as a set of constraints specific to the problem at hand, such as specification of subsets of warehouses that must open.

The Geoffrion-Graves model provides for multiple commodities and a means of retaining the supply point identity of a product as it passes through a warehouse. This makes it easier to exclude unacceptable routes, such as in the case of commodities which are perishable or deteriorate, and to deal with in-transit storage which can have a cheaper transport plus storage cost than transfer in and out of a warehouse.

In terms of the postharvest handling of grains this set of models provides great flexibility in the choice of emphasis for the analysis. Questions of reducing grain losses and changes in drying, storing, and handling procedures can be examined along with the effects of changes in fuel costs and the trade-off between the construction of large-scale centralised storage and handling systems versus a more widely distributed network of smaller-scale plants. In using

the Geoffrion-Graves type of model for grains it also becomes possible to specify some of the constraints specific to a region or existing handling system. As with other models discussed above there are essentially two ways in which to treat time in such models. The first is by optimising over a set of time periods and making explicit the time transformation using storage costs and discounting. A second is to view the way in which decision makers operate as being involved in a time sequence of decisions so that the decision this period is based on results from last period (Day 1973). Such recursive modelling would be possible with the Geoffrion-Graves model. A combination of both types in a rolling-horizon model would also be possible. Such models would then allow for the possibility of the staged introduction of facilities with large capital costs.

Price Responsive Models — Spatial Equilibrium Models

In this section three results will be presented. The first is the solution of a standard spatial equilibrium model; the second is the solution of such a model using linear programming rather than quadratic programming; and the third is a brief discussion of the Polito model, which combines the Geoffrion-Graves model and the spatial equilibrium model. Some comments will then be made on the use of such models in relation to postharvest grain handling.

Although the definition of a spatial price equilibrium model is not entirely clear in the literature, in the context of this paper it will be taken to encompass any model of a trading system which includes transportation costs and provides for the endogenous determination of market prices. Special cases of this model are the transportation models discussed in the previous section. In this case supplies and demands are perfectly inelastic or fixed. Models which determine prices as imputed prices or shadow prices are included only as special cases of the more general model. The significance of this type of model is in the treatment of prices as endogenously determined so that in the evaluation of policy changes in a trading system the effects of those changes on market prices and therefore supply and demand responses can be assessed.

Enke (1951) first developed a solution to the spatial price equilibrium model using an electric analog. This was soon to be followed by the work of Samuelson (1952), in which the solution of the spatial equilibrium model was shown to be a mathematical maximisation problem which could be solved by the repeated application of linear programming to a transportation problem similar to that outlined above. Although numerous authors

have contributed to the literature [a simplified presentation is given in Martin (1981)], the definitive work on these models is now that of Takayama and Judge (1971). Their major contribution was to show the duality of the models constructed using quantity as the dependent variable in the demand and supply functions with models constructed using price as the dependent variable. Also important was their recognition that maximisation of a net social revenue objective function could give equivalent solutions to those of maximising net social welfare. This provided the way for generalising their models to the case of multiple commodities in which symmetry of the supply and demand coefficient matrices was not required. In practical terms this was a significant advance since in the real world of estimated and approximated supply and demand functions there are many reasons why this symmetry may not hold. In fact, the symmetry was only required because of the need to use producer and consumer surplus measures as the objective function.

To illustrate the nature of the spatial equilibrium model a version of the well-known 'back-to-back' trade diagram used by Samuelson (1952) will be used. Consider two geographically separate points of consumption and supply, potentially belonging to one market area but initially separated by a complete ban on trade between the two points. For each of the regions the supply and demand functions are known and might have been estimated by econometric means or simply by knowing the amounts supplied or demanded and the supply and demand elasticities. The situation may be represented graphically, as in Figure 1.

In Figure 1 the intersection of the supply, S_i , and demand functions, D_i , is shown for each of the two regions before trade is allowed to occur. The excess supply, ES_i , and excess demand functions, ED_i , are also shown. In both regions the equilibria are such that excess supply and demand are zero and the pre-trade equilibrium prices are represented as \bar{p}_i . If trade is now permitted to take place between the two regions a new set of equilibrium prices will be determined as p_i . So that the new equilibrium can

take place, product will flow from the low-priced region to the high-priced region. Trade will continue to take place until prices in the two regions are equal, since traders can make a profit until the price difference is zero (transfer costs were assumed to be zero).

In Figure 1 the equilibrium supply quantity is x_1 and the equilibrium demand quantity is y_1 and the shipment from region 1 to region 2 is x_{12} . In the case of two regions the shipment matches the difference between the supply and demand quantities in each region.

Next, introduce transfer costs and this situation is as represented in Figure 2. Introduction of such costs has a number of effects on the solution. To solve the model it now becomes a problem of deciding whether or not traders will find it profitable for trade to take place and if so in which direction it will occur. In general, for trade to take place between any two regions the difference in pre-trade equilibrium prices must be greater than the transfer cost between those two regions. As before, the direction of trade will be from the lower priced region to the higher priced one since anyone shipping goods from one region to another must be able to cover the costs of the purchase of the goods and the transfer costs once the goods are sold in another region.

The effect of introducing transfer costs is to reduce the volume of trade and to raise the price in the region to which the goods are being shipped and lower it in the region from which the goods are being shipped. There is also now the possibility that no trade will occur between two regions even though their prices differ. This will be because the price difference is insufficient to cover the cost of transfer of the goods. It is this problem which makes the spatial equilibrium model with transfer costs difficult to solve mathematically. It is also this feature which requires that mathematical programming models be used in which inequality constraints are included and for which use of the 'complementary slackness' condition is required.

What has been provided so far is an intuitive explanation of why a spatial equilibrium can be

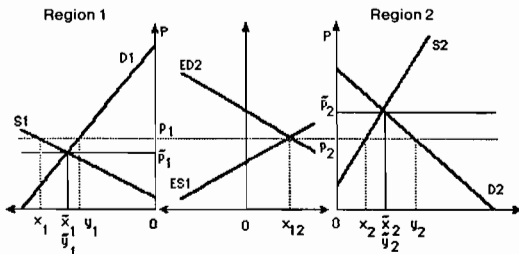

Fig. 1. Representation of supply and demand functions in a spatial equilibrium with no transfer costs.

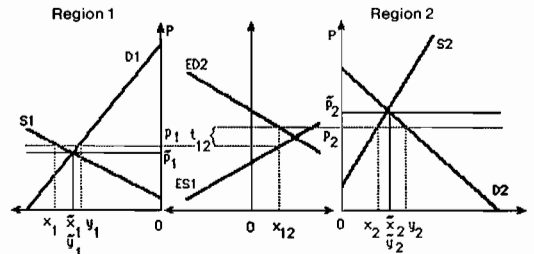

Fig. 2. Representation of the spatial equilibrium model when transfer costs are applicable.

attained in a set of competitive and spatially connected markets. Takayama and Judge (1971) have used two approaches to show how an equilibrium is attained. The first follows the development by Samuelson of a welfare maximising objective while the second uses the notion of maximising a social net revenue function (i.e. revenue less costs summed over all markets and for a competitive market system the optimal solution has a value of zero). In relation to the welfare objective function, Samuelson (1952, p. 288) stated that '... the magnitude is artificial in the sense that no competitor will be aware of or concerned with it. It is artificial in the sense that after an Invisible Hand has led us to its maximisation, we need not necessarily attach any social welfare significance to the result.' In the sense indicated by Samuelson, any mathematical objective function we might use to solve a spatial equilibrium problem is only a mechanism for achieving mathematically what is achieved by competitive market forces. In this context it is worth noting that the two types of objective function with appropriate formulations of the mathematical programming models generate the same equilibrium solutions.

Samuelson (1952) perceived the spatial equilibrium problem in terms of consumer and producer surpluses but because of the recognised difficulties with such measures he preferred to refer to the objective defined in terms of net social payoff and measured as the area under the excess supply or demand curve. Takayama and Judge (1971, p. 181) use the term quasi-welfare.

Using the excess-supply and demand diagram in Figure 2, the net social payoff or quasi-welfare can be derived. The area under the excess demand curve up to the traded quantity x_{12} represents the quasi-welfare gains of those who consume the traded quantity while the area under the excess supply curve represents the quasi-welfare cost of the traded quantity. In shipping the goods the transfer costs

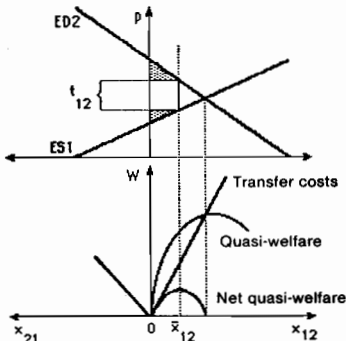

Fig. 3. Representation of the maximum net quasi-welfare solution for the spatial equilibrium model.

must also be subtracted from the quasi-welfare gains to get the net quasi-welfare. Plotting the value of quasi-welfare (area at each level of trade), the total transport cost, and the resultant net quasi-welfare as the quantity traded increases, provides the lower part of the diagram for Figure 3. The net quasi-welfare function is quadratic in form and has a maximum where the difference in prices associated with the quantity traded equals the transfer cost. If the price difference were to be any smaller then there would be insufficient gain for arbitrageurs to ship the full quantity so that they would reduce the amount shipped until the price difference does equal the transfer cost. If the traded amount had to be reduced to zero then no trade would take place; thus, the requirement that the difference between the two prices must be less than or equal to the transfer cost (i.e. 'less than' when no trade occurs and 'equal to' when trade does take place). It is also necessary that the total quantity demanded not exceed the total quantity supplied.

A rather more intuitive approach to the objective function for such models is given by the notion of maximising net revenue. One of the interesting aspects of such an approach is that the same results are obtained as those from a net quasi-welfare maximum. However, the net social revenue model is more general in that it is possible to handle situations where the cross-coefficients between products for both the supply and demand curves are not symmetric.

Consider again the excess supply and demand functions shown in Figure 2. If the vertical difference between the two curves is plotted against

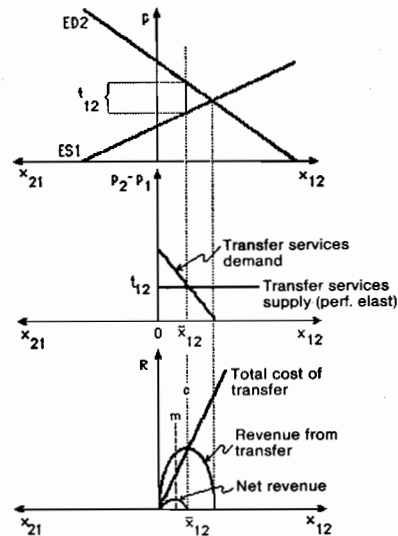

Fig. 4. Representation of the net social revenue solution for spatial equilibrium models.

and

$$(\rho'_y \rho'_x X' w' v') \leq 0' \quad (27)$$

Equation (25) and the inequalities (26) and (27) form the primal-dual price version of the net social revenue form of the spatial equilibrium model. Takayama and Judge (1971, p. 164 and pp. 252-255) were able to show that if a solution exists to this problem then it satisfies the conditions for a competitive spatial equilibrium.

To simplify the mathematical notation, the vectors w and v will be ignored in the subsequent argument since they make no difference to the essential logic of the formulation and are only included to deal with certain irregular cases as outlined in Takayama and Judge (1971, pp. 156-157).

Problem 2: Maximise

$$\left| \begin{array}{c} \alpha \\ -\theta \end{array} \right| - \left| \begin{array}{c} B \\ \Gamma \end{array} \right| \left| \begin{array}{c} \rho_y \\ \rho_x \end{array} \right|' \left| \begin{array}{c} \rho_y \\ \rho_x \end{array} \right| - T'X \quad (28)$$

subject to

$$\left| \begin{array}{c} \alpha \\ -\theta \end{array} \right| - \left| \begin{array}{c} B \\ \Gamma \end{array} \right| \left| \begin{array}{c} \rho_y \\ \rho_x \end{array} \right| - \left| \begin{array}{c} G_y \\ G_x \end{array} \right| X \leq 0 \quad (29)$$

and

$$(\rho'_y \rho'_x X') \leq 0'. \quad (30)$$

This problem may be simplified by removing v and w so as to give Problem 3:

$$\text{Maximise NSR} = d'\rho - \rho'H\rho - T'X \quad (31)$$

$$\text{subject to } d - H\rho - GX \leq 0 \quad (32)$$

$$-T + G'\rho \leq 0 \quad (33)$$

$$(\rho'X') \geq 0', \quad (34)$$

where G is a combined matrix of G_y and G_x , d is the combined intercept vectors, ρ the combined supply and demand price vectors, and H the matrix of demand and supply slope coefficients (note that the off-diagonal matrices of H have been assumed to be zero as this restricts the applicability of the conclusions in the following sections and, in particular, excludes the case of ad valorem tariffs).

The Lagrangian function and Kuhn-Tucker conditions for problem 3 are:

$$\phi = d'\rho - \rho'H\rho - T'X + k_1'(-d + H\rho + GX) + k_2'(T - G'\rho) \quad (35)$$

$$\partial\phi/\partial\rho = d - 2H\rho + Hk_1 - G'k_2 \leq 0 \quad (36)$$

$$\text{and } (\partial\phi/\partial\rho)'\rho = 0,$$

$$\partial\phi/\partial X = -T + Gk_1 \leq 0 \quad (37)$$

$$\text{and } (\partial\phi/\partial X)'X = 0,$$

$$\partial\phi/\partial k_1 = -d + H\rho + GX \geq 0 \quad (38)$$

$$\text{and } (\partial\phi/\partial k_1)'k_1 = 0,$$

$$\partial\phi/\partial k_2 = T - G'\rho \geq 0 \quad (39)$$

$$\text{and } (\partial\phi/\partial k_2)'k_2 = 0.$$

$$(\rho'X'k'_1k'_2) \geq 0'. \quad (40)$$

Spatial equilibrium models have normally been solved by using quadratic programming algorithms (Takayama and Judge 1971) for which there is a considerable number of computer programs (for some comparisons see McCarl and Tice 1982). For the standard spatial equilibrium model, formulated as a primal-dual model, a minor change can be made which makes it possible to solve a subset of spatial equilibrium problems by using linear programming. The change involves setting some of the constraints to be equalities rather than inequalities and dropping the quadratic part of the objective function. Without fully developing the proof for this proposition it can be observed that if the term $\rho'H\rho$ is dropped from equation (35) then condition (36) becomes:

$$\begin{aligned} \partial\phi/\partial\rho &= d + Hk_1 - G'k_2 \leq 0 \\ \text{and } (\partial\phi/\partial\rho)'\rho &= 0. \end{aligned} \quad (41)$$

By the construction of a primal-dual model the set of primal solution variables (ρ and X) must be the same as the set of dual variables (k_1 and k_2) at the optimum, that is, in this case ρ will equal k_1 and X will equal k_2 . Thus, at the optimum, condition (36) can be written as:

$$\begin{aligned} \partial\phi/\partial\rho &= d - H\rho - G'k_2 \leq 0 \\ \text{and } (\partial\phi/\partial\rho)'\rho &= 0. \end{aligned} \quad (36a)$$

If, by a suitable modification of the linear program, k_1 is equal to the negative of ρ then the two conditions (41) and (36a) would be equivalent at the optimum. Recognising that the Lagrangian multiplier for an equality constraint may take on positive or negative values (an equality constraint can be represented by two inequalities of the opposite direction) then the linear programming problem may be formulated as Problem 4:

$$\text{Maximise } Z = d'\rho - T'X \quad (42)$$

$$\text{subject to } d - H\rho - GX = 0 \quad (43)$$

$$-T + G'\rho \leq 0 \quad (43)$$

$$(\rho'X') \geq 0'. \quad (45)$$

The Kuhn-Tucker sufficient conditions for an optimum of this problem, where k^*_1 is the Lagrangian multiplier for the equality constraint, are:

$$\phi = d'\rho - T'X + k^*_1'(-d + H\rho + GX) + k_2'(T - G'\rho) \quad (46)$$

$$\partial\phi/\partial\rho = d + Hk^*_1 - G'k_2 \leq 0 \quad (47)$$

$$\text{and } (\partial\phi/\partial\rho)'\rho = 0,$$

$$\partial\phi/\partial X = -T + Gk^*_1 \leq 0 \quad (48)$$

$$\text{and } (\partial\phi/\partial X)'X = 0,$$

$$\partial\phi/\partial k^*_1 = -d + H\rho + GX = 0, \quad (49)$$

$$\partial\phi/\partial k_2 = T - G'\rho \geq 0 \quad (50)$$

$$\text{and } (\partial\phi/\partial k_2)'k_2 = 0.$$

$$(\rho'X'k'_2) \geq 0' \text{ and } k^*_1 \text{ unrestricted.} \quad (51)$$

Multiply equation (49) through by -1 . Then, for the two conditions (46) and (49) to be consistent with each other (as they are in the full quadratic problem), k^*_1 must be negative, given that k_2 is constrained to be positive. Condition (48) is now affected, but because the matrix G is patterned to form differences of the k^*_1 variable, these constraints will not be violated if k^*_1 is negative. Thus, in this situation, conditions (47) and (48) are made independent of (49) and (50). For an optimum linear program, therefore, the primal variables (ρ and X) will satisfy the set of sufficient conditions (49) and (50) as in the quadratic problem provided that condition (49) can be satisfied as an equality. In economic terms, this means that supply cannot go unused or demand go unfulfilled. This requirement would normally be of little consequence since extra dummy regions can always be added. The dual variables k^*_1 and k_2 will not have the same values as ρ and X since they are 'shadow' values in terms of a different objective function. This, however, need be of no concern since the full set of prices and quantities which represent the solution of the spatial equilibrium model are obtained in ρ and X .

Although the full implications of the solution of a subset of spatial equilibrium models by linear programming have not yet been fully explored the approach would seem to open up avenues for the solution of the combined spatial equilibrium type model with the plant location type of model using integer programming. Such a model has been outlined and solved by Polito (1977).

The Polito (1977) model combines the Geoffrion-Graves and Takayama-Judge models so that a mixed-integer, quadratic programming problem is defined. In his formulation Polito used the net social quasi-welfare objective function for the spatial equilibrium model and formulated it in the quantity dependent form. This particular formulation, with demand and supply functions expressed as price dependent on quantity, links readily with the warehouse location model of Geoffrion and Graves. The objective function for the spatial equilibrium model represents the sum across all regions and commodities of the difference between producer and consumer surpluses less the transfer and warehousing costs.

The Polito model may be written as Problem 5: Find s, d, X, r, Z , and y so as to minimise

$$NSW = \begin{vmatrix} v \\ s \\ -\lambda \end{vmatrix} \begin{vmatrix} s \\ d \end{vmatrix} + 0.5 \begin{vmatrix} s \\ d \end{vmatrix} \begin{vmatrix} H & 0 \\ 0 & \Omega \end{vmatrix} \begin{vmatrix} s \\ d \end{vmatrix} - T'X - \sum_{mjk} V_k r_{mjk} \quad (52)$$

subject to

$$-\sum_{jk} x_{imjk} + s_{mi} \geq 0 \quad \text{for all } m \text{ and } i \quad (53)$$

(supply balance)

$$\sum_i x_{imjk} - r_{mjk} = 0 \quad \text{for all } m, j \text{ and } k \quad (54)$$

(warehouse in-flows)

$$\sum_k r_{mjk} - d_{mj} \geq 0 \quad \text{for all } m \text{ and } j \quad (55)$$

(demand balance)

$$\sum_m r_{mjk} \leq U_k y_{jk} \quad \text{for all } j \text{ and } k \quad (56)$$

(no flows on disallowed routes)

$$\sum_k y_{jk} = 1 \quad \text{for all } j \quad (57)$$

(each demand region from one warehouse)

$$L_k z_k \leq \sum_{mj} r_{mjk} \leq U_k z_k \quad \text{for all } k \quad (58)$$

(no flow through closed warehouse)

$$N_1 z_k \leq \sum_j y_{jk} \leq N_2 z_k \quad \text{for all } k \quad (59)$$

(closed warehouses cannot supply)

Linear constraints on z_k and/or y_{jk} , and $(s, d, X, r) \geq 0$ and $z_k, y_{jk} \in (1, 0)$, (60) (61)

where

i, j index the supply and demand regions with $i = 1, 2, \dots, N_1$ and $j = 1, 2, \dots, N_2$,

m indexes the commodities with $m = 1, 2, \dots, M$,

k indexes the warehouses or processing plants with $k = 1, 2, \dots, K$,

U_k is the upper capacity limit for warehouse k ,

L_k is the lower capacity limit for warehouse k ,

T is a vector of t_{imjk} transportation costs for commodity m from region i to j through warehouse k ,

X is a vector of x_{imjk} quantities shipped of commodity m from region i to j through warehouse k ,

V_k is the per unit charge for shipping through warehouse k ,

z_k is equal to 1.0 if warehouse k is open, zero otherwise,

y_{jk} is equal to 1.0 if warehouse k serves demand region j , zero otherwise,

s_{mi} is the quantity of commodity m supplied by region i ,

d_{mj} is the quantity of commodity m demanded by region j ,

r_{mjk} is the quantity of commodity m shipped from warehouse k to demand region j ,

H is an $(M \times N_1 \times M \times N_1)$ symmetric matrix of supply function slope coefficients for the M commodities and N_1 supply regions from price-dependent supply functions,

Ω is an $(M \times N_2 \times M \times N_2)$ symmetric matrix of demand slope coefficients for the M commodities and the N_2 demand regions from price-dependent

demand functions,

v is an $M \times N_1$ vector of supply intercept coefficients, and

λ is an $M \times N_2$ vector of demand intercept coefficients.

The important feature of the model is the inclusion of price sensitive supply and demand functions. In addition, the model has built in an optimisation process for the selection of warehouse locations each with multi-commodity flows through them (this could be various types of grains in the grain-handling case). Increasing or decreasing marginal cost functions could be specified with appropriate bounds on the piecewise-linear segments of the cost functions. Plant capacity limits can also be specified. In specifying the demand systems it would be possible to view the system as representing the situation of a perfectly competitive firm facing a perfectly elastic demand function through to a situation of fixed forecast demands. Various degrees of competition might also be represented. The market prices generated by the system are such as to reflect the equalisation of marginal costs at the point of sale of the product.

The question of fixed costs is a difficult one in the case of this model and is not clearly resolved. At the equilibrium solution it can be shown that total revenue just equals total costs (the zero profit condition of a perfectly competitive market). Since only variable costs are included in the model no allowance has been made for fixed costs in such a solution, so that if a fixed cost is included the system would be associated with a negative profit result. To overcome this, Polito (1977, p. 77) added an additional constraint to require that total revenue covers fixed and variable costs. This has the effect of raising market prices and price no longer equals marginal cost so that the solution represents something between monopolistic and competitive pricing. Polito suggests that the most satisfactory way of handling fixed costs is to calculate for each warehouse or processing plant the likely volume to pass through the warehouse, divide this into the fixed cost (presumably amortised), and add this to the v_k coefficient. If the volumes turn out to be significantly under- or over-estimated recalculate the average per unit fixed cost and solve again.

The method of solving the system proposed by Polito (1977) was to use a combination of quadratic programming, mixed-integer programming, and a transportation algorithm using Benders' decomposition. The model has been structured so that warehousing costs and the transportation costs are separate thus allowing decomposition into a series of standard transportation models. Computational experience reported by Polito for

this procedure was that very large problems could be solved with ease and with reasonable amounts of computer time. Computational experience with a similar algorithm and model is reported by Litzenberg et al. (1982) where it is noted that for a small problem with 15 supply points, 15 processors, and 10 demand regions (that is 275 variables with 25 quadratic and 47 constraints) the solution was faster on the RAND QP algorithm (Cutler and Pass 1971). For their large problem of 3381 variables (106 quadratic) and 198 constraints, RAND QP was not large enough to handle the problem.

From the foregoing observations it is clear that the solution of problems of realistic size and complexity in the transformation of products in time, space, and form can be achieved and at reasonable cost. Models are available which can accommodate, at least approximately, many of the difficult decisions involved in the postharvest handling of grains. However, the models reported in this paper do not provide for resolution of the difficult issues of risk and uncertainty and some of the more subtle questions of dynamics, such as changes in behaviour as a result of changes policy makers may make to the economic environment. These models also, to be realistic, require large amounts of data of high quality. The trade-off between the complexity of model representation versus data quality is not easily resolved.

Concluding Comments

So, what of modelling economic systems? Economists still have a great deal to learn about the real world application of models. It is easy to claim much for their benefits but very difficult to deliver definitive answers. The economic systems modelled do not always work as they have been modelled — perfectly competitive markets are rarely found. Often economists are in the invidious position of not being able to do experiments to test their hypotheses. Neither are the models always capable of handling the very great variety of processes involved in an economic system. In addition, computational abilities are still limited in relation to the ability to collect data and put it within a structured framework. The ability to extract information from data is also somewhat limited.

Too often, applied economists forget the numerous additional constraints under which politico-socioeconomic systems operate. The desire to maintain high levels of employment in existing industries, the lobbying power of this group or that, the social conventions involved with certain economic processes, the constraints of conventional behaviour, the self-interest of people in power, and the sheer difficulties of changing a system too

rapidly. It is often easy to recommend changes which will have a lower cost or greater return but the important question is whether or not there are real savings to be made or real benefits to be gained and what is the distribution of those costs and benefits. To add to the wealth of the already wealthy may gain an economy little, whereas to add to the wealth of the poor may provide very real benefits. The interpretation of the results from modelling work is probably more important than the data collection and model construction itself and it is often the modeller who gains most from the modelling work as opposed to the individual or organisation for whom the work was done. The ability to communicate what has been learned about an economic system in a written paper or conference presentation is very limited indeed.

It is not surprising that politicians and other decision makers are skeptical and disbelieving of the results of modelling work. They usually have not been through the analytical steps involved in the modelling, nor have they had to think through the conclusions from their particular perspective of responsibility. It is also most likely that a model builder will have started out with very different preconceived notions as to what is important and what is not important compared with the decision maker who has to take all the 'flak' if something goes wrong.

Further, the type of model used very often implies certain preconceived notions about how the system works. By their nature, optimising models usually involve some fairly strong behavioural assumptions. Econometric models may be more neutral in this sense but the model builder has a far greater opportunity to impose his or her beliefs on the structure of the model. The model of perfect competition is often used as the base against which policy scenarios are evaluated. This may be appropriate in some instances but in others may be an entirely inappropriate base for evaluation. When looking at costs and benefits of changes to the existing system such comparisons against the perfectly competitive model may be quite false, whereas for assessment of the costs of the existing system against a perfect ideal then such comparisons might be appropriate. The original questions must be clearly defined.

In attempting to make recommendations on the basis of modelling work one of the most difficult problems is how to deal with the uncertainty and reliability of the estimates. Very rarely are attempts made to put error bands on model results used for policy analysis and on the few occasions in which they have been reported or presented they have been so large as to be embarrassing. This is a particular problem with mathematical programming models,

since the techniques for doing so have not been well developed and need further research. Extensive sensitivity analysis is one approach but not very convenient in terms of obtaining an overall evaluation of the reliability of a model.

In conclusion, it seems reasonable to suggest that proposals for modelling work must be carefully presented to decision makers in terms of what can be delivered at the end of the day. It also seems reasonable to suggest that economists must continue to improve their modelling work, the data collections on which it is based and, most importantly, how the results of modelling work are interpreted. For analysis of the postharvest handling of grains it would seem important to proceed cautiously in attempting to come to terms with improvements to the system. Various analytical techniques are available but they are still limited as to the size of the problem which can be handled, the assumptions under which they must be applied, and their usefulness. Various approaches to analysing changes to the system should be tried. Models which not only help us to look at the efficiency effects but which are also sufficiently detailed to permit serious examination of the distributional consequences of changes should be considered. With the introduction of a bulk-handling system, what will be the employment consequences and will the small trader be able to get a job working on the storage bins at an even higher income? If the modelling work cannot provide a direct answer to this type of question then the report to management should at least attempt an answer.

References

- Bressler, R.G., and King, R.A. 1970. Markets, prices and interregional trade. New York, John Wiley & Sons, 426 p.
- Bunday, B.D. 1984. Basic linear programming. London, Edward Arnold, 163 p.
- Cooper, L. 1963. Solutions of generalised locational equilibrium models. *Journal of Regional Science*, 7, 1-18.
- Cutler, L., and Pass, D. 1971. A computer program for quadratic mathematical models to be used for aircraft design and other applications involving linear constraints. A report prepared for the United States Air Force project RAND. Santa Monica, Rand Corporation, 113 p.
- Day, R.H. 1973. Recursive programming models: a brief introduction. In: Judge, G.G., and Takayama, T. ed., *Studies in economic planning over space and time*. Amsterdam, North-Holland Publishing Company, 329-344.
- Ellewein, L.B., and Gray, P. 1971. Solving fixed charge location-allocation problems with capacity and configuration constraints. *AIIE Research Quarterly*, 3, 290-298.

- Enke, S. 1951. Equilibrium among spatially separated markets: solution by electric analog. *Econometrica*, 19, 40-48.
- Faminow, M.D., and Sarhan, M.E. 1983. The location of fed cattle slaughtering and processing in the United States: an application of mixed integer programming. *Canadian Journal of Agricultural Economics*, 31, 425-436.
- Fuller, S.W., Randolph, P., and Klingman, D. 1976. Optimising subindustry marketing organisations: a network analysis. *American Journal of Agricultural Economics*, 58, 425-436.
- Geoffrion, A.M., and Graves, G.W. 1974. Multicommodity distribution system design by Benders decomposition. *Management Science*, 20, 822-844.
- Hilger, D.A., McCarl, B.A., and Uhrig, J.W. 1977. Facilities location: the case of grain subterminals. *American Journal of Agricultural Economics*, 59, 674-682.
- Hurt, V.G., and Tramel, T.E. 1965. Alternative formulations of the transshipment problem. *Journal of Farm Economics*, 47, 763-773.
- King, G.A., and Logan, S.H. 1964. Optimum location, number and size of processing plants with raw product and final product shipments. *Journal of Farm Economics*, 46, 94-108.
- Kolstad, C.D., and Burris, A.E. 1986. Imperfectly competitive equilibria in international commodity markets. *American Journal of Agricultural Economics*, 68, 27-36.
- Kottke, M. 1970. Spatial, temporal and product use allocation of milk in an imperfectly competitive dairy industry. *American Journal of Agricultural Economics*, 52, 33-40.
- Ladd, G.W., and Lifferth, D.R. 1975. An analysis of alternative grain distribution systems. *American Journal of Agricultural Economics*, 57, 420-430.
- Leath, M.N., and Martin, J.E. 1966. The transshipment problem with inequality restraints. *Journal of Farm Economics*, 48, 894-908.
- Leath, M.N., and Martin, J.E. 1967. Formulation of a transshipment problem involving time. *Agricultural Economics Research*, 19, 7-14.
- Lee, S.M., Moore, L.J., and Taylor, B.W. 1985. *Management science*, 2nd edn. Dubuque, Iowa, Wm. C. Brown Publishers, 910 p.
- Lee, S., and Shim, J. 1986. *Micro management science*. Dubuque, Iowa, Wm. C. Brown Publishers, 426 p.
- Litzenberg, K., McCarl, B.A., and Polito, J. 1982. Decomposition solution for partial equilibrium problems. *American Journal of Agricultural Economics*, 64, 590-594.
- MacAulay, T.G. 1976. A recursive spatial equilibrium model of the North American beef industry for policy analysis. Guelph, Canada, University of Guelph, Ph.D. thesis.
- Martin, L.J. 1981. Quadratic single and multi-commodity models of spatial equilibrium: a simplified exposition. *Canadian Journal of Agricultural Economics*, 29, 21-48.
- McCarl, B.A., and Tice, T. 1982. Should quadratic programming problems be approximated? *American Journal of Agricultural Economics* 64, 585-589.
- Monterosso, C.D.B., Wright, C.L., Lacerda, M.C.S., and Ofugu, N. 1985. Grain storage in developing areas: location and size of facilities. *American Journal of Agricultural Economics*, 67, 101-111.
- Maruyama, Y., and Fuller, E.I. 1965. An interregional quadratic programming model for varying degrees of competition. Bulletin 555. Amherst, Massachusetts Agricultural Experiment Station, University of Massachusetts, 43 p.
- Nelson, C.H., and McCarl, B.A. 1984. Including imperfect competition in spatial equilibrium models. *Canadian Journal of Agricultural Economics*, 32, 55-70.
- Plessner, Y. 1971. Computing equilibrium solutions for imperfectly competitive markets. *American Journal of Agricultural Economics*, 53, 191-196.
- Polito, J. 1977. Distribution systems planning in a price responsive environment. Purdue, Purdue University, Ph.D. thesis.
- Samuelson, P.A. 1952. Spatial price equilibrium and linear programming. *American Economic Review*, 21, 283-303.
- Song, D.H., and Hallberg, M.C. 1983. An analytic model of the imperfect world trade market: a case study of world wheat cartels. *Canadian Journal of Agricultural Economics*, 31, 389-400.
- Stollsteimer, J.F. 1963. A working model for plant numbers and locations. *Journal of Farm Economics*, 45, 631-645.
- Takayama, T., and Judge, G.G. 1971. *Spatial and temporal price and allocation models*. Amsterdam, North-Holland Publishing Company, 528 p.
- Tapiero, C.S. 1971. Transportation-location-allocation problems over time. *Journal of Regional Science*, 11, 377-384.
- Toft, H.I., and Cassidy, P.A. 1985. Networking or transshipment? Optimisation alternatives for plant location decisions: an example from Australian wool marketing logistics. Working Paper in Econometrics and Applied Statistics No. 16. Armidale, Department of Econometrics, University of New England.
- Toft, H.I., and Cassidy, P.A. 1986. The development and characteristics of transshipment models and the application of these models in studies of location, distribution and logistics. Research Report No. 19. Brisbane, Business Research Centre, Brisbane College of Advanced Education.
- Toft, H.I., Cassidy, P.A., and McCarthy, W.O. 1970. Sensitivity testing and the plant location problem. *American Journal of Agricultural Economics*, 52, 403-410.
- Tyrchniewicz, E.W., and Tosterud, R.J. 1973. A model for rationalising the Canadian grain transportation and handling system on a regional basis. *American Journal of Agricultural Economics*, 55, 805-813.
- von Oppen, M., and Scott, J.T. 1976. A spatial equilibrium model for plant location and interregional trade. *American Journal of Agricultural Economics*, 58, 437-445.

Applications of Optimisation Techniques for the Grains Postharvest Sector in the Humid Tropics

G.J. Ryland *

Abstract

In this paper, selective applications of transportation and spatial equilibrium models in the humid tropics are examined to provide an indication of the main policy issues that these models have addressed. Five issues are explored: the role of raw material and commodity pricing policy; storage policy; quality analysis; centralised versus a more dispersed pattern in the provision of grain handling facilities; and intersectoral linkages. It is believed that models which do not focus on these core issues may not be relevant for policy and investment planning purposes of grain handling and transportation in the humid tropics.

THERE has been increased emphasis in recent years on improving the performance of the postharvest sector in countries in the humid tropics. This has occurred for two main reasons. Firstly, the production situation has changed to such an extent that, in many countries, food supply is no longer the limiting constraint on improving national welfare. Production rationalisation, adjustment, and rehabilitation of agricultural enterprises have resulted in the emergence of a farm problem, a problem which has been the focus of interest of agricultural policy makers in developed economies for some time. Secondly, there has been an increased demand for postharvest services in developing countries in which, as income increases, consumers are prepared to pay more for increased marketing services. The former situation relates to the necessity to improve the performance of the postharvest sector by reducing postharvest losses and reducing costs. The latter is related to the need to match the increased demand for postharvest services by adjusting marketing services (or price) to increased demand for quality grains. Whether the need for increased marketing services is either supply or demand generated (or both) is an interesting topic in itself and will depend on the situation under examination. The main thrust in this paper,

however, is to provide the appropriate conceptual framework for analysing technological and policy choices in the postharvest sector of the humid tropics.

Transportation and location studies, with extensions to include the full range of spatial, temporal, and quality equilibrium analysis, have for some time been the concern of applied economic researchers, particularly in relation to the transportation and handling of cereal grains. Basically, there are two formal approaches depending upon whether market prices are specified as exogenous or endogenous.

Exogenous price models in which market prices and costs are given are referred to as production allocation models. Those models which simultaneously determine market prices as well as production are of the general class of pricing and production allocation models. The latter class of models are usually associated with Takayama and Judge (1971) type formulations. In empirical terms, however, the main concern of researchers in the humid tropics has been with production allocation models, as market prices of the commodity under examination are usually regulated.

Consequently, the empirical applications with which we will be concerned relate mainly to production-location allocation models in which market price and transport costs are assumed constant. Costs of storage processing and drying are throughput related or vary with size of the facility.

* G.J. Ryland & Co., Economic Consultants, P.O. Box 114, Glen Osmond, South Australia.

In this economic environment, the underlying objective is to minimise the total of transport and grain-handling costs from raw material supply sources through storage, drying, and processing facilities for distribution of final product to consumers. Imposed on this system are constraints to ensure that raw material supplies are less than availabilities, bottlenecks in the system are recognised, and that demands at consuming centres are at least satisfied.

Given this economic framework, the dominant issues for policy purposes are discussed briefly below.

Discussion of Major Policy Issues

Centralisation versus Decentralisation of Facilities

Storage and transport planners in many developing countries have historically adopted a 'think big' strategy by centralising storages in larger units located at a few central places such as ports or consuming centres. Several reasons have been advanced for this storage location pattern. Firstly, there are potential size economies to be exploited with the construction of larger storages which suggest that reduction in cost through increasing size more than offsets the extra costs associated with assembling the raw material. A second and rather attractive attribute is that assembly at fewer larger places makes subsequent allocation decisions to demand centres easier.

According to Green (1982), this choice of storage/location pattern in Africa has served only to worsen transport bottlenecks in the system. A study of grain drying location in Malaysia by Soo Lip Tan (1971) concluded that grain drying location is throughput related and with more throughput additional dryers were required which suggests a decentralisation strategy. A recent empirical study by Monterosso et al. (1985) of rice handling/storage in Brazil, suggests that location of grain drying and storage at or near farms avoids spoilage, reduces dead weight by 5 to 10% thereby making farm to storage transport more expensive per unit distance than transport from storage point to final destinations. However, in these studies no account has been taken of the purchasing policies for raw material (paddy), which may serve to offset any transport cost savings through decentralisation.

While these empirical studies support the decentralisation of storage and handling facilities to production locations, purchasing policy by Government has probably been the main deciding factor in the tendency toward concentration of facilities. Recent work by Chew and Loo (1985) and

Chew and Ghaffar (1986) provides evidence of market failure in the current pricing structure of paddy in Malaysia.

Storage Policy

Development planners and agencies are particularly interested in the issue of the appropriate balance between raw material and final product storage requirements. The amount of final product storage of a commodity depends not only on speculative storage behaviour decisions but also on strategic reasons such as food security and/or as part of a domestic price stabilisation scheme. The U.K. Tropical Development and Research Institute (TDRI) has recently completed (Gray and Mitchell 1986) some interesting work on buffer stock strategies operated by the National Logistics Agency, BULOG, in Indonesia. These models are concerned mainly with the temporal issue of how much and over what lead time storage is required before release.

A much more complex issue is how much to store, and at what place, for subsequent distribution of the commodity to final end users. Apart from the Indonesian study noted above, there does seem to be very little research on spatial and temporal allocation decisions for a single commodity in the humid tropics. This would seem to be an important issue particularly in periods of potential surpluses of grains when there is considerable need for additional storages. In the case of rice, for example, storage of dried paddy incurs much lower postharvest losses from insect infestation than does storage of milled rice. Yet, there is considerable excess capacity in the processing sector where the aim seems to have been to mill paddy as fast as possible. If governments are to maintain large quantities of stored grain as part of a country's insurance against fluctuations in local production, then planners need to identify the product type and location, as well as temporal dimensions of the storages. The recent TDRI study of BULOG's minimum stock reserves did not consider the former issue. As stocks become older, it is clear that BULOG will need to pay increased attention to the problem of preserving grain quality through adoption of more efficient and effective pest control methods.

In addition, there probably needs to be a change in procurement policy, in order to provide sufficient incentive for changes in handling technology from bag to bulk. Ryland (1986a, b) has discussed the interdependencies among storages, drying, transport, and distribution activities in the postharvest sector in the humid tropics that need to be included so that changes in policy and technology can be analysed simultaneously.

Pricing Policy

In all Asian economies, with the possible exception of Thailand, the government has invariably intervened to support the local rice industry. Intervention has occurred mainly through providing input subsidies on irrigation water, fertiliser, and seeds, and output subsidies by directly subsidising paddy prices and through administering prices for milled rice. The result of this intervention is the stimulation of local food production through increasing self sufficiency to boost incomes of producers so as to reduce the income inequalities between urban and rural households and to save foreign exchange. The impact of government intervention results in a massive transfer from consumers to producers, causing a significant reduction in net social welfare that would not occur in the absence of price support policies. However, intervention by government has also resulted in resource misallocation at producer level, to the detriment of the whole rice handling and distribution system through distortion in the procurement system. There is no incentive to produce good quality rice, since price support policies distort the incentives system.

In addition, the high support prices for rice also have resulted in rice having a comparative advantage relative to secondary food crops such as maize and legumes. It has impeded the adoption of more efficient technology such as bulk handling and improved facilities for drying the wet paddy. Invariably, the improved technology is available but price support policies impede its adoption. Consequently, what is needed is a change in policy rather than further investments in newer and presumably more technically efficient technology.

In the model developed for analysing the transition from bag to bulk handling of paddy and rice in Malaysia (ACIAR 1986), the major constraint on its adoption is the pricing system for procuring paddy supplies. If this were changed, handling of the paddy and rice in bulk would be introduced, and the speed of adoption would depend critically on the extent of incentives included in the policy package.

Private or Public Ownership

Planning of grain-handling facilities in developing economies is mainly the province of the central government. However, where there are private traders and millers, such as in Thailand, there does appear to have been established a much more efficient grain-handling and distribution network. Exploitation of farmers by middlemen in the marketing chain is only a perception since competition will always act as a constraint on excessive profit-making.

It is sometimes argued that competition amongst grain handlers would result in much waste in terms of a reduction in resource use relative to public ownership, which is a luxury developing economies can ill afford. It is also sometimes argued that monopolies are better equipped to exploit the economies of scale of storage and processing equipment. This has been one of the main arguments for preserving monopoly powers of grain-handling authorities in Australia.

The pattern of development of grain-handling facilities is often analysed in terms of the multifacility monopolist who will allocate production such that marginal costs are equal at each plant. If the monopolist then acts to set prices equal to marginal production costs at each plant, he is also acting according to purely competitive behaviour. Thus, cost minimising patterns of production and networks are also those which may occur under decentralised decision making. Private ownership by itself need not necessarily improve efficiency unless there are competitive elements introduced into the system to eliminate economic rents accruing to the institutionalised structure of the industry. The point is that a public monopoly, acting benevolently, can operate at least as efficiently as a purely competitive industry.

Quality Analysis

While the main direct benefit of improvements in transportation, grain handling/storage, and the procurement system is the reduction in postharvest losses in terms of increased yield per unit of time, another benefit which may be of at least equal importance is the impact of changes in the transportation, grain-handling/storage system on the quality of the product. There may, for example, be substantial quality losses such as from pesticide residues, increased broken/damaged grain, and discoloration which influence consumer preferences and hence the price of the product. Qualitative losses may be perceived to be more important by discriminating consumers, particularly in surplus grain markets in which increased yields exert a downward pressure on prices. Consequently, empirical analyses of the benefits of improved grain-handling/storage technology should include not only the production aspects of reduced losses but also qualitative aspects.

A conceptual framework for analysing the impacts of changes in quality on consumer prices stemming from changes in storage, drying, and pest control systems can be developed using Lancaster's (1966) 'new theory of consumer demand' and the implicit price models of Ladd and Suvannunt (1976) based on product characteristics.

While the challenge of empirical resolution in this

important area remains, Champ and Ryland (1986) have recently extended Hedley's (1972) model of economic threshold levels of pesticide applications to include qualitative as well as quantitative losses.

Intersectoral Linkages

The agro-processing sector, which includes the marketing chain from producer through to consumer, is influenced by changes in the farming system such as labour and capital availability, and also changes in end use and marketing strategies. Consequently, the grain-handling and storage system in the humid tropics has to be sufficiently versatile and flexible to meet these changing circumstances. For example, among the reasons that mechanical grain drying equipment has not been adopted throughout Asia is not only the lack of pricing incentives but also the very low levels of capacity utilisation. Also, the developed technology is not multifunctional. Grain drying can be made more cost effective if it is multipurpose (covering maize, paddy, groundnuts, fish, and meat) and multifunctional — integrated with a storage system so that different drying strategies can be applied on the different raw materials. Diversification in the farming system will increase the demand for multipurpose, multifunctional mechanical drying equipment.

Linkages with the traded goods sector (exports and imports) are also important for grain exporting and net grain importing countries. The system must be integrated with the traded goods sector so that sufficient storage must be provided to meet export and satisfy import requirements.

Grain storage and handling involve massive amounts of capital (about US\$100.00 per tonne for constructing permanent storage) and hence capacity utilisation is important. In the U.S. grain-handling system, there are very high annual turnover rates (2.5-3 are common) while in Australia there are relatively low throughput ratios. Consequently, those involved in planning storage and handling facilities must recognise the need to achieve high capacity utilisations as well as consider directional movements of grain and their influence on the system. Koo (1982) has stressed the importance of export demands on directional movements of grain in the U.S.

Conclusions

In this paper I have attempted to focus on those issues that I believe are significant and relevant for policy and investment planning purposes in the grain-handling/storage sector of the humid tropics. However, the most pressing need in this sector is not for major changes in technology but for changes in the pricing system for paddy, rice, and corn. Fewer

government interventions, reduction in regulations, and increased competition will improve the economic performance of this sector. If these policy changes are included in the grain-handling, storage, and distribution system, individual economic agents in the marketing chain will be provided with sufficient incentive to adopt improved technology such as grain drying, storage, and pest-management systems, thereby satisfying the latent demand of consumers for high quality products at competitive prices.

References

- ACIAR. 1986. Bulk handling of paddy and rice in Malaysia. Preliminary results of ACIAR Project 8344. Presented at 9th Annual technical seminar on grain postharvest technology, ASEAN Crops Post-Harvest Programme. August, 1986, Singapore.
- Champ, B.R., and Ryland, G.J. 1986. The role of residual pesticides in stored product insect control. Presented at 4th International working conference on stored-product protection. September 1986, Tel Aviv, Israel.
- Chew, T.A., and Ghaffar, R.A. 1985. Some economic aspects of drying of paddy by farmers in Selangor, Malaysia. Presented at 9th Annual technical seminar on grain postharvest technology, ASEAN Crops Post-Harvest Programme. August 1986, Singapore.
- Gray, J., and Mitchell, M. 1986. Summary report of a study of minimum grain stock reserves. London, Tropical Development and Research Institute.
- Green, R.H. 1982. Agricultural crisis in sub-Saharan Africa. Brighton, Sussex, Institute of Development Studies, 73-79.
- Hedley, J.C. 1972. Defining the economic threshold. In: Pest control strategies for the future. Washington, D.C., National Academy of Sciences, 100-108.
- Koo, W. 1982. Economic analysis of domestic and ocean transportation for U.S. grain shipments. North Dakota State University Agricultural Economics Report No. 164.
- Ladd, G.W., and Suvannunt, V. 1976. A model of consumer demand for goods characteristics. *American Journal of Agricultural Economics*, 58, 504-510.
- Lancaster, K.J. 1966. A new approach to consumer theory. *Journal of Political Economy*, 74, 132-157.
- Monterosso, C., Wright, C., Lacerda, M., and Ofugi, N. 1985. Grain storage in developing areas: location and size of facilities. *American Journal of Agricultural Economics*, 67(1), 101-111.
- Ryland, G.J. 1986a. An assessment of the benefits and costs of pest control in humid, tropical grain storage systems. In: Champ, B.R., and Highley, E., ed. Pesticides and humid tropical grain storage systems: Proceedings of an international seminar, Manila, Philippines, 27-30 May 1985. Canberra, ACIAR Proceedings No. 14, 343-347.
- 1986b. The economics of grain drying in the humid tropics. In: Champ, B.R., and Highley, E., ed. Preserving grain quality by aeration and in-store drying: Proceedings of an international seminar, Kuala

Lumpur, Malaysia, 9-11 October 1985. Canberra, ACIAR Proceedings No. 15, 141-145.

Soo Lip Tan. 1971. A study of the optimum size, number and location of padi driers for the Muda area. Kuala

Lumpur, University of Malaya, M.Agr.Sc. thesis.

Takayama, T., and Judge, G.G. 1971. Spatial and temporal price and allocation models. Amsterdam, North-Holland Publishing Co.

Economic Aspects of Postharvest Handling and Storage — Modelling

Session Chairman's Summary

R.K. Lindner *

FIRST let me record my appreciation to Dr Sarun Wattanutchariya, who was the rapporteur for this session, and without whose assistance I could not have prepared this report.

Second, I should compliment the speakers on the quality of their papers. Professor Koo 'set the scene' very nicely with his excellent exposition of the coordination problem in the postharvest grain-handling system, and of the potential benefits to society which can be realised by solving this problem in what economists refer to as an efficient manner. He also explained very clearly the economic principles underlying the problem of modal choice in the transportation subsystem, and of how the interaction between upgrading and assembly costs can influence the best method of handling and storing grain. Finally, he explained how economic models can be used to investigate the efficiency of alternative grain-handling systems, such as bulk handling versus the more traditional system of bagging the grain before it is transported; and he drew a useful distinction between intraregional and interregional models.

Dr MacAulay's paper complemented that of Professor Koo by concentrating on the analytical techniques used in these so-called 'transportation' models to derive optimal allocations of resources in grain marketing systems. I found his classification scheme a particularly helpful guide to how the various studies in this area relate to each other. His final comments, on recent theoretical breakthroughs which allow simpler optimising techniques such as linear programming to be used to analyse the more complex, and realistic, price responsive models, were especially encouraging.

In the third paper, Dr Ryland shifted the focus of the debate to more practical issues that arise in the application of the optimising models to specific grain-handling systems in the humid tropics. His identification of six issues that are encountered when economists attempt to model actual marketing systems provided a most helpful agenda for subsequent discussion.

Almost all of the discussion related to the following interrelated themes:

- despite their sophistication, do these types of models adequately address the complexity of 'real world' marketing systems?
- are such sophisticated models really necessary, or would much simpler models be as good, or at least more cost-effective?
- how does government intervention in the marketing system affect the validity of these models, and conversely what can such models tell us about the relative merits of leaving postharvest handling and transportation of grains to private enterprise as compared with having government control?

Notwithstanding the fact that the marketing system only involves product transformation of one form or another, the complexity of the coordination problem

* School of Agriculture, University of Western Australia, Nedlands, W.A. 6009.

involved should not be underestimated. The multiplicity of possible collection points means that transformations in space (i.e. transport networks) are almost infinitely variable. Furthermore, such transport route choices interact with modal choices, as do choices about storage duration (i.e. transformations over time), which are also continuously variable. Finally, there are choices about transformation in form (e.g. drying) which also interact with all of the above choices. In market economies, decision-making about this multiplicity of transformation choice is decentralised to greater or lesser degree, and the coordination of these individual decisions in the best interest of society is a very complex problem. Just how complex is illustrated by the highly sophisticated optimisation techniques which have been found to be necessary in modelling studies of this problem.

Despite the sophistication of these techniques, a number of discussants were critical of these transportation models on the ground that they still failed to capture important aspects of reality. For instance, most studies have not taken account of fluctuations over time in output, in final demand by consumers, and in costs of the various forms of transformation. Another concern was the reality of the transformation cost functions, and in particular whether they adequately allowed for differences in types of freight, road conditions, etc. While such deficiencies in modelling studies can be correct in principle, in practice it is at the expense of even greater model complexity.

How much complexity is warranted in these models is an important issue which was discussed at some length. Some speakers argued for simpler models in order to reduce the costs of conducting such studies, but others felt this approach would be undesirable as the ability of the models to systematically evaluate all possible alternatives would be compromised. As the cost of computing power continues to fall, this may become less of an issue, although the costs of collecting the necessary data, and of distilling some wisdom from mountains of computer output should not be underestimated.

The other major theme in the discussion was the value of findings from such studies, and its interaction with the need for government intervention in the grain-handling system. If, as was argued by several speakers, a competitive market can solve the coordination problem outlined above, then there is no apparent value from modelling exercises in countries where the grain-handling system is run by competitive private enterprise. Not surprisingly, not all participants shared this view, and instead argued that government intervention is necessary to ensure efficient coordination. More importantly, government involvement in grain handling is a fact of life in many countries, and one way in which transportation models can be used is to highlight the efficiency gains or losses associated with such intervention.

**Economic Aspects of Postharvest
Handling and Storage — Applied Studies**

Opening Remarks on Current Research Methodology

C.W. McCormac *

HISTORICALLY, ex-ante economic analysis of national (i.e. Southeast Asian) grain postharvest systems and the economies in which they operate, for the purposes of identifying constraints, opportunities for new technology, and policy formulation, has been limited. The recognition of economics as a necessary discipline in the development, testing, and on-site evaluation of grains postharvest technology is recent. At the institutional level, resource allocations for developing and sustaining a postharvest economics research capacity have been neglected compared with crop production, and are significantly less than needed.

Economic analysis of new postharvest technologies generally takes the form of a financial analysis, with costs and benefits internalised to part or all of a single well-defined (private or public) enterprise. Externalisation and calculation of net social costs and benefits are often ignored. Associated with this is a method of evaluating benefits only in terms of assumed and unchanging prices for increased supplies and/or qualities of grains. Sensitivity analysis using data from market studies needs more attention in these calculations.

The economic criteria used are almost exclusively monetary in nature. Management requirements, changes in location-specific 'social contracts', effects on farm production techniques, risk and uncertainty, are seldom considered or defined. These can be important issues regarding the individual enterprise, or government decision to invest.

Applied economic studies need to be developed and, where possible, conducted incorporating an understanding of the technical definition of the problem and possible alternative technical solutions under consideration. The appropriate arithmetic of the economic analysis may range from partial budgets to complex econometrics; that is *not* the main issue. What is important is that economic analysis identify the relevant variables, and correctly evaluate their relationships and changes in those relationships as a consequence of technological change. Government participation in national grain postharvest systems is often associated with large-scale operations and for those it is likely that applied bioengineering research will develop and test computer assisted management practices, as is now the case for large scale crop production. These systems will need to be evaluated in terms of cost reductions in handling, storage, and maintaining grain quality.

* International Development Research Centre, P.O. Box 101, Tanglin, Singapore 9124.
(Session D Chairman)

Issues Determining the Capitalisation of the Rice Processing Industry in the Philippines

Zenaida F. Toquero *

Abstract

The grain processing industry in the Philippines has undergone some substantial changes in terms of expansion and modernisation of its facilities and operations in the past 25 years. A number of these efforts to improve and modernise the industry, however, have not been successful, for a variety of technical, economic, sociocultural, and political reasons. In this paper, an attempt will be made to examine the different variables, their impact on the modernisation scheme, and the effects they might have had on capital and labour.

THE capitalisation and improvement of the rice processing industry in the Philippines started slowly in the late 1950s. The objective was to improve the rate of milling recovery and upgrade the quality of milled rice. The construction of four large milling complexes with on-site drying and storage facilities was one of the first attempts to introduce modern facilities. Mechanical threshers, dryers, and improved warehouses and mills likewise spread gradually throughout the country.

Many of these efforts to modernise the industry, however, have not been successful. A considerable proportion of the bulk silos and highly integrated mills (with expensive grain-handling equipment) are standing idle or are being used at a small fraction of their capacity. The problems encountered in introducing new facilities and technology resulted from faulty design and construction, wrong location, poor management, insufficient consideration by the promoters of the new technology of the many practical problems involved (such as inadequate supply of uniform paddy to run the processing facilities at full capacity for an extended period), sociocultural constraints, government pricing policies, shortages of finance, and changing economic conditions. These different factors attest to the fact that rice processing as a system must be viewed holistically. Modernisation

of postproduction facilities must therefore be associated not only with technical efficiency but must also adapt, in an appropriate way, to the social and economic requirements of the industry.

This paper examines the economic, sociocultural, technical, and political issues as they affect the capitalisation of the Philippine rice processing industry.

Economic Issues

Commodity Flows

Coloma (1969), in his study of trade patterns of paddy or rice, noted that there are two types of geographical movements of rice in the Philippines: (a) movement within a province or region (movement is from the production area to the urban centres and then to the small towns and local markets); and (b) interprovincial or interregional movements.

There are two main interregional flows of paddy and rice in the Philippines (Fig. 1). One is the north-south movement in Luzon where produce from Cagayan Valley moves south to Central Luzon which in turn sends the paddy to Manila, Southern Tagalog, and Bicol regions. There is also a large movement from Manila to the Visayas, and a small one from Manila to Mindanao, primarily during the lean months of March and April. Minor movements to neighbouring provinces along the way occur during harvest time.

* Southeast Asian Regional Center for Graduate Study in Agriculture, College, Laguna, Philippines, 3720.

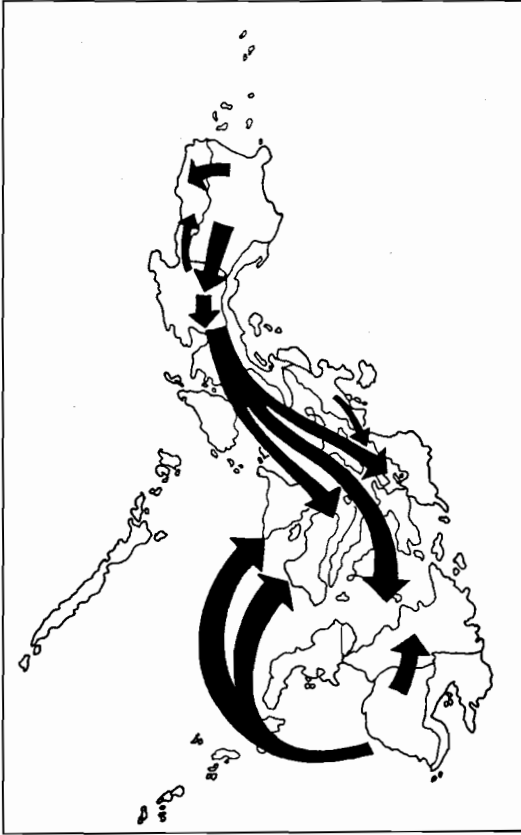

Fig. 1. General interregional flows of paddy/rice in the Philippines, 1967-68 (from Coloma 1969).

During the second half of the year, from July to September, the interregional flow of rice is from Southern and Western Mindanao in an upward (or south-north) movement to Western and Eastern Visayas and Northern and Eastern Mindanao.

Figure 2 presents the domestic trade channels through which paddy/rice flows in the Philippines. From the multitude of small farms, the marketable surpluses are disposed of through the trade channels and concentrated in commercial warehouses. The flow starts with the farmer bringing the paddy on his sled or cart directly to the local warehouse. The greater bulk of the market-directed paddy, however, is first assembled into bigger lots by country buyers in the production area. These buyers may be local paddy dealers, local rice retailers, transient paddy dealers ('viajeros'), or commission agents of the warehouse establishments. The paddy procured by these country buyers is transported in motor vehicles (usually trucks, trailers hitched to jeeps, etc.) from the farms to the warehouses. Most of the paddy is deposited in warehouses located in the same regions, except for that purchased by the 'viajeros', who bring it to their respective provinces.

At the warehouse, paddy is dried to an optimum moisture content before it is finally stored. Paddy is stored in lots of specific varieties or closely related varieties, either in sacks or in bulk. Most commercial warehouses are equipped with disc-cone ('cono-type') huller mills so that almost all of the paddy procured is milled at the establishment where it is initially received for storage. Milled rice is not usually stored for long periods due to its low keeping quality. Therefore, paddy is milled only as orders for it are received. Milled rice is packaged in 50 kg bags.

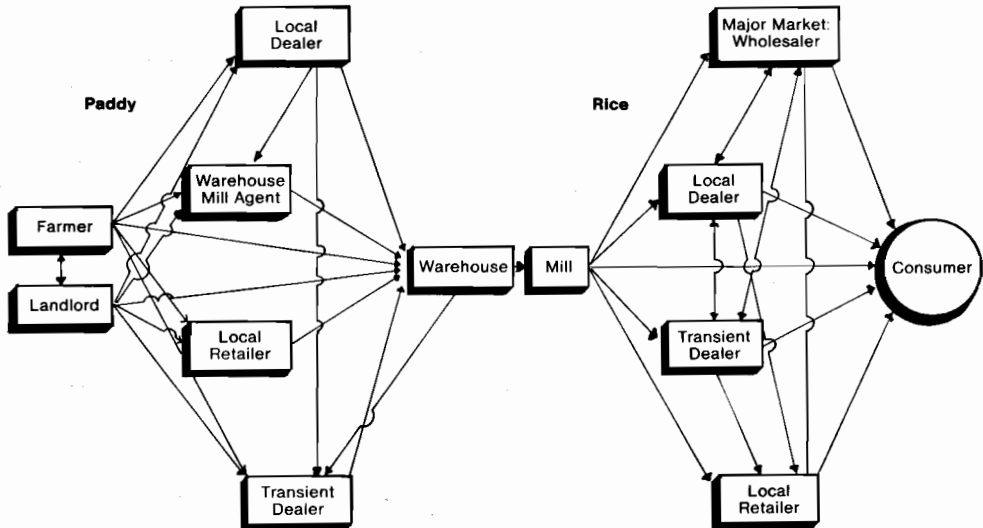

Fig. 2. Domestic paddy/rice trade channels in the Philippines (from Coloma 1969).

From the mill, rice is distributed to its local and interregional markets, either directly to the end users or through several market intermediaries including major market wholesalers, local rice dealers, transient rice dealers, and local rice retailers. These market agencies frequently buy and sell milled rice among themselves. This would be the case when a local rice dealer sells to a transient rice dealer who then brings the rice to a wholesaler in a major market centre such as Manila. The wholesaler may, in turn, sell to another transient dealer who might then resell the commodity to a local rice dealer in another region.

In terms of government procurement, its national marketing agency, the National Food Authority (NFA), buys directly from farmers through buying stations distributed throughout the country (Fig. 3). While NFA owns and leases a few mills and warehouses, it also makes extensive use of private

marketing agencies in handling and moving stocks through government channels. Rice is mainly channelled to the ultimate consumer through the private retail trade.

Economic Environment of the Farmer

The farmers are an important link in the capitalisation of the rice processing industry in that they test the economic viability of any new system and influence its adoption and/or modification. The farmer's receptivity to an improved and/or new processing technology can spell the difference between the success or failure of moves to introduce it. The physical and economic environment of the farmer can explain his interest (or the lack of it) in choosing and/or accepting a given technology.

Small Farm Size. Filipino rice producers are small farmers, about 70% of them operating on less than 3 ha. The predominance of small farmers in rice

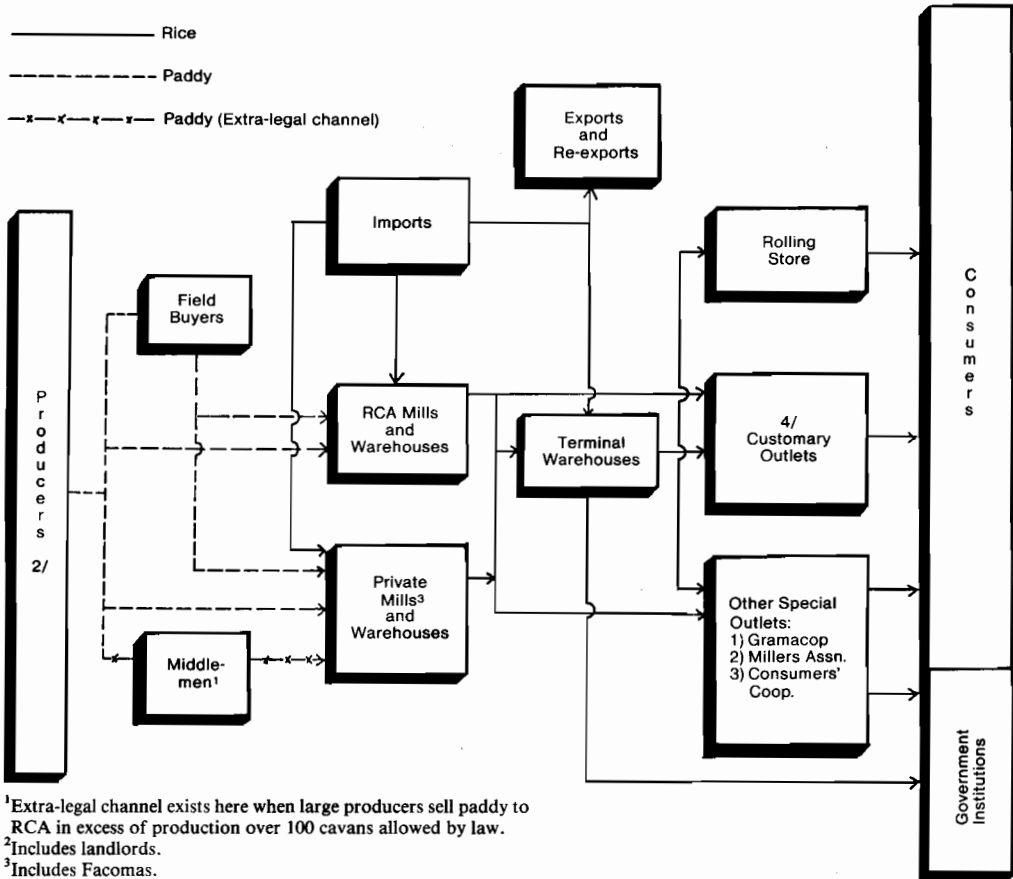

¹Extra-legal channel exists here when large producers sell paddy to RCA in excess of production over 100 cavans allowed by law.
²Includes landlords.
³Includes Facomas.
⁴Customary outlets are RICOB-registered retailers, municipal treasury-appointed retailers and barrio council members.

Fig. 3. Government channels for rice and paddy in the Philippines in the late 1960s (from Hamburgplan 1985).

production is dramatically illustrated by the fact that, in 1960, about 77% of all rice farms were less than 4 ha and by 1972 the proportion had risen to 94% (Table 1). This decrease in the size of rice farms could be attributed to the subdivision of farmlands as a result of a rapidly increasing farm population, especially in densely populated regions. Land fragmentation may also be due to borrowing of a small parcel of land for one crop season by a relative or friend, or the leasing or sub-tenancy of a part of the total farm area. For some larger farms, it could be due to switching to other profitable crops or conversion of unproductive land to housing areas

or subdivisions. The continued parcelling of landholdings among children likewise contributed to the problem.

Low Production. The problem of small-sized, fragmented rice lands is further aggravated by low productivity. Based on Bureau of Agricultural Economics (BAE) time-series data, the average yield per hectare increased from 2.1 t in 1969-70 to 2.9 t in 1982-83. In the case of non-irrigated and upland areas, the average yields were 1.8 and 1.0 t/ha, respectively, for the 1982-83 crop year (Table 2). Of this total output, a tenant operator in Central Luzon gets a 60% share with only 25% being sold in the

TABLE 1. Distribution by size and tenancy of farms cultivating rice, 1960 and 1972.

Category	All farms growing rice, 1960			Farms with rice as major crop								
	Number ^a	Area planted with rice ^b	Average area ^c	1960			1972					
				Number ^a	Area planted with rice ^b	Average area ^c	Number ^a	Area planted with rice ^b	Average area ^c			
Size (ha)												
0 - 1.9	526.7	496.8	0.94	425.9	397.7	0.93	1161.8	1024.4	0.88			
2.0 - 3.9	524.0	966.6	1.84	382.0	800.5	2.10	422.0	1019.4	2.42			
4.0 - 6.9	201.6	519.4	2.58	122.6	415.1	3.39	92.1	436.8	4.74			
7.0 - 9.9	130.3	350.8	2.69	72.6	279.7	3.85	10.1	78.8	7.80			
10.0 - 23.9	75.9	270.0	3.56	35.3	216.3	6.13	4.2	53.8	12.81			
24.0 and above	9.9	126.8	12.86	3.5	100.5	29.05	0.4	19.5	48.75			
Total	1468.4	2730.4	1.86	1041.9	2209.9	2.12	1690.6	2632.7	1.56			
Tenancy												
Owner	614.4	1077.7	1.75	385.2	772.9	2.01	665.1	988.8	1.49			
Part-owner	240.1	463.4	1.93	164.6	359.8	2.19	299.1	490.9	1.64			
Tenant	596.9	1123.8	1.88	479.1	1023.7	2.14	726.4	1143.3	1.57			
Other	17.0	65.6	3.86	13.0	53.4	4.11	n.a.	n.a.	n.a.			
Total	1468.4	2730.4	1.86	1041.9	2209.9	2.12	1690.6	2632.7	1.56			

^aIn thousands

^bIn thousands of hectares, based on World Bank calculations and 1960 agricultural census.

^cIn hectares.

n.a.: not available.

Source: 1960 data from agricultural census; 1972 data from the Bureau of Agricultural Economics.

TABLE 2. Paddy: yield in tonnes per hectare by land use and season, Philippines, 1969/70-1982/83.

Crop year (July-June)	Irrigated			Non-irrigated			Upland			All farms		
	Wet	Dry	Average	Wet	Dry	Average	Wet	Dry	Average	Wet	Dry	Average
1969/1970	2.1	2.0	2.1	1.6	1.2	1.4	1.1	1.0	1.0	1.7	1.7	1.7
1970/1971	2.1	2.0	2.0	1.7	1.5	1.6	1.0	1.0	1.0	1.7	1.8	1.8
1971/1972	2.0	2.0	2.0	1.4	1.4	1.4	1.0	1.0	1.0	1.5	1.7	1.6
1972/1973	2.0	2.0	2.0	1.3	1.0	1.2	1.0	1.0	1.0	1.4	1.5	1.4
1973/1974	2.0	2.2	2.0	2.0	1.0	1.5	1.0	1.0	1.0	1.8	1.4	1.6
1974/1975	2.0	2.4	2.2	1.4	1.3	1.4	1.0	1.0	1.0	1.5	1.9	1.7
1975/1976	2.2	2.4	2.3	1.6	1.3	1.5	1.0	1.0	1.0	1.7	1.8	1.8
1976/1977	2.2	2.3	2.4	1.6	1.4	1.5	1.0	1.0	1.0	2.0	2.0	2.0
1977/1978	2.5	3.0	2.0	1.7	1.3	1.5	1.1	1.0	1.0	2.0	2.1	2.0
1978/1979	2.5	3.1	3.8	2.0	1.5	1.8	1.1	1.0	1.1	2.0	2.4	2.2
1979/1980	2.8	3.0	2.9	1.8	1.6	1.7	1.0	1.0	1.0	2.1	2.3	2.2
1980/1981	2.7	3.0	2.8	1.9	1.7	1.8	1.0	1.0	1.0	2.1	2.4	2.2
1981/1982	2.8	3.1	2.9	2.0	1.7	1.9	1.0	1.0	1.0	2.3	2.5	2.4
1982/1983 (est.)	3.0	2.8	2.9	2.1	1.4	1.8	1.0	1.0	1.0	2.5	2.4	2.4

Source: Policy Analysis Staff, Ministry of Agriculture and Food, based on data from Bureau of Agricultural Economics.

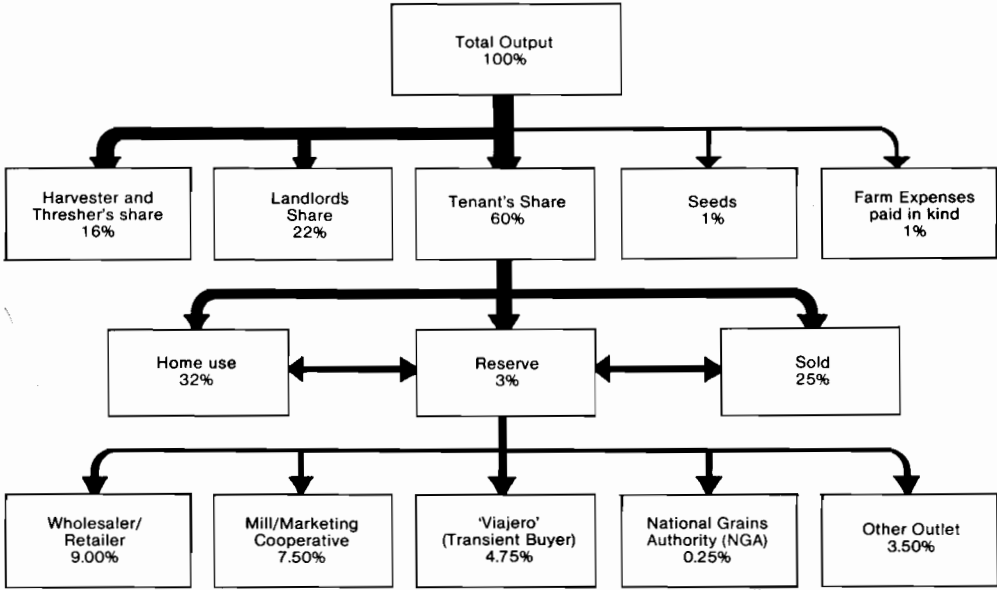

Fig. 4. Production and disposal of paddy by a tenant-operator, Central Luzon, 1974-75.

market (Fig. 4). As the size of the farm household averages 6-7 members, this amount of produce is barely enough to meet their subsistence need and still enable them to pay for their production and other household needs. Thus, it is not uncommon to see farmers committing their produce long before harvest because of a dire need for cash.

Marketable Surplus. Paddy, once harvested, may be utilised for home consumption, for seed, as payment in kind (to landlords, harvester/threshers, etc.), or may be sold for cash (see Fig. 4). That portion of the crop often referred to as the 'marketable surplus' is a residual representing the amount remaining after a farmer's household requirements have been met.

The growth of the marketed surplus is determined by the behaviour of both rice producers and consumers. The fact that rice producers are themselves consumers makes it difficult to determine what proportion of increased production is likely to be market directed. The level of marketable surplus that is ultimately made available involves two major decisions by producers: (a) how much to produce; and (b) how to allocate the production between consumption within the farm household and sale in the market.

A study by Toquero et al. (1975) showed that as production per household member increases (Q/N) there is an almost proportional increase in household consumption (C/N) up to a production level of about 260 kg of paddy per member per year (Fig. 5). Consumption below this level represents the reservation demand of the household and will

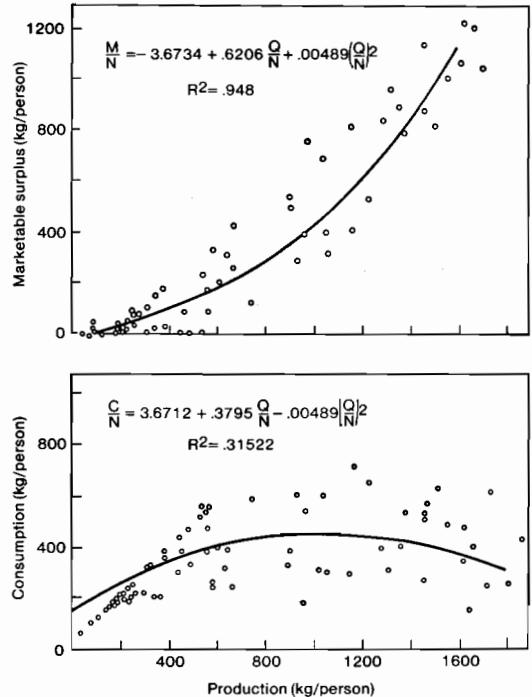

Fig. 5. Relationship between household consumption, marketable surplus and production for Philippine rice farms.

usually be satisfied first.¹ When production per capita exceeds the needs of the family, the farmer will begin to sell the surplus (M) in the market. The result of a regression analysis carried out in the study indicated that production is not highly price elastic in the subsistence range of output and that producer's home consumption of rice is not sensitive to price changes. This is clearly in contrast to the traditional argument that a negative price response exists in the market supply for a given output (e.g. Mathur and Ezekiel 1961). The study likewise noted that the proportion of crop moving into the market is relatively responsive to change in output. In general, it was found that the elasticity of the marketable surplus function is much higher for increases in production than for similar proportional changes in price. This suggests that increases in output resulting from the development of new technology or improvement in basic infrastructure would have a strong positive influence on the increase in the marketable surplus for paddy.

On the basis of the above evidence, it seems reasonable to conclude that the marketed surplus of rice in the Philippines has been growing more rapidly than production by 50% or more on average. This is confirmed by the BAE time series data, which show that the proportion of paddy

actually sold in the market increased from 26% in 1969-70 to 37% in 1982-83 (Table 3). This amount could be even larger if one considers payments-in-kind given to the landlord, the harvester/ threshers, and the hired labour which will probably find their way into the marketing channel. They would increase the percentage of paddy marketed from 58 to 71%.

Large Number of Paddy Varieties. Farmers tend to plant one or more varieties of paddy in their farms as insurance against crop failure due to pest and disease infestation. Moreover, some farmers set aside parcels in their farms to plant 'fancy' varieties reserved for the home or for some special occasion. According to BAE data, four general categories of rice varieties are harvested in the country: IR-series (produced by the International Rice Research Institute, IRRRI); BPI-series (produced by Bureau of Plant Industry); College-series (produced by the University of the Philippines at Los Baños); a fourth category including other varieties, mostly traditional and/or upland, not originating from any of the above-mentioned institutions. The IR-series dominated the market, accounting for 61% of paddy area harvested in 1978 (Table 4). This can be attributed to the intensified rice production program called Masagana 99 by the Ministry of Agriculture and Food. The category embracing other varieties ranked second in importance, followed by the College- and BPI-series.

Quality Standards and Grades

Rice quality standards and grades have traditionally been neglected in the Philippines' rice price policy. Until the early 1980s the official pricing scheme did not adopt price differentials with respect

¹ A study by Toquero and Duff (1974) on farm level post-production practices indicated that farmers often sell significant quantities of paddy at output levels below saturation. In many instances, the immediate need for cash to repay debts or finance purchases supersedes the longer term need for the subsistence food. In these cases, the farmer must then purchase rice or paddy at a later date to meet his consumption requirements.

TABLE 3. Paddy: percentage reserved by farmer and percentage marketed, Philippines, 1969/70-1982/83.

Crop year ^a (July-June)	Reserved by farmer				Marketed		
	Home Consumed	Seeds	Feeds	Total	Sold	Others ^b	Total
1969/70	26	3	1	30	26	44	70
1970/71	25	3	1	29	26	45	71
1971/72	30	4	1	35	23	42	65
1972/73	34	7	1	42	25	33	58
1973/74	29	7	1	37	28	35	63
1975/76	34	4	1	39	35	26	61
1976/77	33	4	1	38	33	29	62
1977/78	36	4	1	41	32	27	59
1978/79	36	4	1	41	32	27	59
1979/80	35	4	1	40	38	22	60
1980/81	36	4	1	41	34	25	59
1982/83	32	4	c	36	37	27	64

^aNo data available for 1974/75 and July-December 1977 data are indicated for 1977/78.

^bIncludes landlord's share, harvester and thresher's share, loan repayment, given away, and losses.

^cLess than 1%.

Source: Policy Analysis Staff, Ministry of Agriculture and Food, based on data from Bureau of Agricultural Economics.

TABLE 4. Paddy: percentage distribution of area harvested of high yielding and other varieties, Philippines, 1968-78.

Item	1968	1969	1970	1971	1972	1974	1975	1976	1977	1978
IR-series	13	27	33	36	40	45	46	52	55	61
BPI-series	8	9	4	2	2	1	1	^a	3	2
College series	^a	5	7	12	14	17	14	12	10	7
Other varieties	79	59	56	50	44	37	39	36	32	30
Total	100	100	100	100	100	100	100	100	100	100

^aLess than 1%.

Source: Bureau of Agricultural Economics.

to grain quality and market location. Ceiling prices were uniformly fixed in all regions of the country, consistent with support prices. The agency price, however, is apparently not available to most farmers because it is offered only at buying stations along paved, accessible roads.

At the farm level, prices of paddy are differentiated among fancy, special, and ordinary² varieties which reflect the consumers' tastes and preferences rather than market quality (Aspiras 1969; Mears et al. 1974; Unnevehr 1983). Thus, the demand for rice in the Philippines brings a price premium to rice variety and appearance, with less value being placed on head rice. It is therefore very common for the marketed rice to contain a very high percentage of broken kernels partly because the paddy entering the mills is not segregated by quality standards³ either physically or with respect to prices. The sale price of milled rice does not reflect the proportion of broken kernels present.

Many mills are able to produce high quality rice but for financial reasons they refrain from doing so. Broken kernels are often remixed with the whole kernels before bagging as this practice maximises revenue. In addition, the custom milling demands of the rice farmer, especially in the rural areas, as related to his use of the by-products, place little importance on the amount of whole kernels.

The problem of quality standards and grades is compounded by the fact that the Philippine set of quality standards for paddy and milled rice had been patterned after the U.S. standards for export

quality, which are very stringent (de Padua 1977). Thus, practically all Philippines paddy is off-grade compared with Thailand or U.S. grade (Table 5). For instance, Thailand's white rice 5% (the fifth from the top grade) is almost comparable to the Philippine Grade no. 1 (the highest grade) and the United States Grade no. 2 (the second from the best grade).

Pricing Policies

The main thrust of the Philippine Government's pricing policy has been to keep consumer prices as low as possible while providing sufficient income incentives to domestic producers to meet the government's goal of raising agricultural productivity. To implement this policy, the government sets targets for floor prices of paddy at the farm level and for ceiling prices at the retail level. These targets are achieved through market intervention in terms of the procurement and distribution activities of the NFA.

The government's attempt to establish floor and ceiling prices for rice and corn has not succeeded to the point of establishing reliable upper and lower limits on the market price. Between 1974 and 1983, there was no year in which both farm gate and retail prices were within the official bounds. Farm paddy prices were below the official floor prices from 1975 to 1983 (Fig. 6). This problem can be attributed to a variety of interrelated factors, including: (a) unavailable and inadequate government funds for the procurement and distribution activities of the

TABLE 5. Comparison of Philippine and U.S. grain standards for rice.

Grade	Percentage Tolerance	
	Philippines	United States
No. 1		
Broken grain tolerance	10	4
Tolerance of other varieties	2	1
No. 3		
Broken grain tolerance	30	15
Tolerance of chalky kernels	15	6
Tolerance of other varieties	5	3

Source: de Padua (1977).

² According to grain appearance, each type of grain is classified as:

Fancy which possesses a flinty uniform appearance, glossy, shiny and translucent or creamy white in colour.
Special which exhibits a rather less uniform white appearance than fancy class; creamy white to light gray in colour.

Ordinary class has a duller white colour than the fancy and special class.

³ This practice stems from the farm-level sale of small quantities of any one variety to small traders who then combine or mix their purchases for further sale.

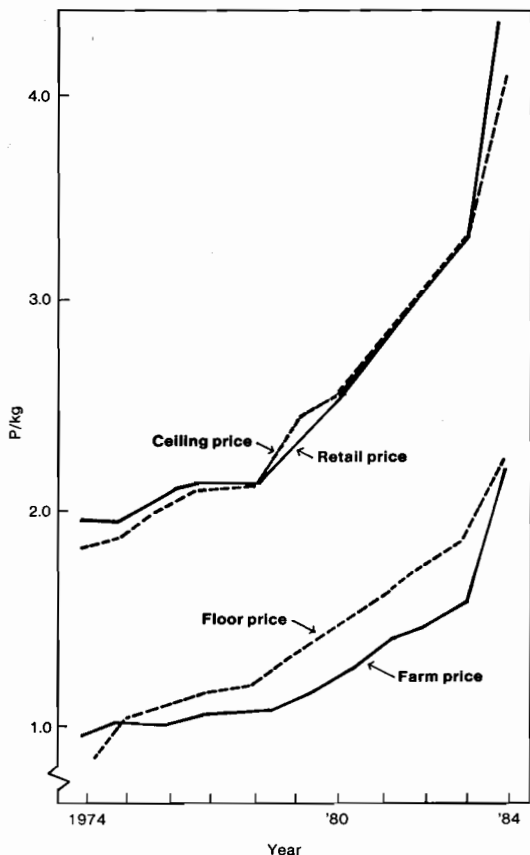

Fig. 6. Official floor and ceiling prices, and retail rice prices and farm paddy prices, Philippines, 1974-84.

NFA⁴; (b) inadequate market information, accentuated by credit, transport, and storage deficiencies⁵; (c) absence of adequate buffer stocks appropriately distributed in warehouses around the country with suitable sales outlets ready to sell rice when prices rise; and (d) the policy of trying to supply rice at ceiling prices only to low-income families without regard for the price in the rest of the market. In such circumstances, black market opportunities lead to manipulation that reflects on the entire price control effort.

An analysis of domestic market by Lantican and Unnevehr (1986) shows that defence of the ceiling

⁴ The NFA has not been regularly funded but is dependent on occasional ad hoc loans from government financial institutions.

⁵ When bonded warehousemen are not willing or available for actual buying, the NFA has to arrange to buy directly.

price has been more effective than defence of the floor price. Disbursements are determined by high rice prices, while procurements have not been concentrated where prices are lowest. Domestic floor and ceiling prices are not defined with respect to location or rice grade for ceiling prices.

Capital-Labour Substitution

The capitalisation of the rice processing industry will have an impact on the relative endowment of capital and labour in the economy.

In a labour surplus economy such as the Philippines a move for capitalisation would likely avert a downward pressure on the wage rate. In the Philippines, the agricultural labour force has been growing at a rate of 1% per year (David 1983). This has been accompanied by a decline in real agricultural wages which are presently lower than in the mid-sixties. This would indicate that employment opportunities in the agricultural sector have been lagging behind growth in the labour force. Adoption of labour-saving devices such as mechanical harvesters, threshers, dryers, and milling complexes would therefore be expected to further reduce agricultural wage rates.

The post-production phase is one of the most labour-intensive parts in the rice industry. Post-production operations are usually carried out by hired labourers who belong to the poorest segments of the society—landless and marginal farm households, jobless people, etc. A move to mechanise would therefore be likely to affect labour and employment either by direct displacement or through foregone employment opportunities. However, in the analysis of impact of capital-intensive technologies on employment, it is always difficult to isolate the relationship between the two issues because higher levels of capitalisation are often accompanied by higher levels of other factor inputs and management, as well as changes in the operation of the system. Therefore, a mere reduction in labour requirements due to the time and labour efficient features of a given technology cannot be readily considered as labour displacement without examining the changes (forward and backward linkages) that may occur in the total rice processing system.

Therefore, a more intensive analysis of the whole system is required to account for the possible indirect employment that may arise from backward linkages with suppliers of post-production facilities and/or equipment, the forward linkages towards processing and distribution, the multiplier links through the expenditure of incomes created in the production process, and possibly foreign exchange multipliers arising from the elevation of paddy and milled rice quality to export standard.

Socio-Cultural Issues

In considering postharvest food losses in developing countries, the U.S. National Academy of Sciences (1978) noted that 'Cultural attitudes and societal practices form the inescapable and critical backdrop against which postharvest operations and loss reduction as well as perception of food loss are appraised. The techniques of food conservation are frequently dictated more by traditional beliefs than by immediate utility. Traditional practices, therefore, are not likely to be abandoned when new technologies and methods are demonstrated and perceived to be effective improvements, and also do not result in intolerable strains on social structures, income levels and distribution . . .'

Institutional Arrangements. Long-established institutional arrangements in the postproduction phase exist in most rice-producing regions of the Philippines. Because they are based on the country's culture and way of life, they are not easily changed.

In the Philippines, harvesting and threshing are the highest paid forms of farm employment, primarily because of the tradition of sharing the crop. Wages earned in post-production activities are the most significant source of annual income for landless labourers. A farmer will never harvest his own field because other members of the community, particularly the landless, would be denied their chance to share in the resources in order to survive. The crop-sharing system is an important social institution for income redistribution, both among members of the extended family (from the landed to the landless members of the family) and within the barrio.

In the 'gama' system, by agreeing to weed a farmer's rice field, but not to be paid immediately, the labourer creates an obligation on the part of the farmer to be hired for harvesting and threshing. If a farmer shifts to mechanical threshing, he will lose his weeders under the 'gama' system. He will also deprive his neighbours of their livelihood, something he may not be prepared to do because he has a social conscience or because he wants to keep his neighbours' goodwill.

Even in the trading of paddy, several institutional arrangements exist. A good example of these is the buyer-seller relationship called 'suki' which is a practice of patronising one store or buyer instead of buying at different stores at different times. Repeated transactions between a buyer and a seller often build personal trust and a feeling of mutual obligation. The buyer expects lower prices, good quality, personal favours, and credit as part of the services. The vendor, on the other hand, is supposed to anticipate his customer's wishes, suggest the better choice among commodities, welcome him,

and offer small extra services, such as storing packages for the customer. While the 'suki' relationship appears to be based upon mutual economic advantage, it differs from similar buyer-vendor exchanges used in Western societies because it reflects the special importance of reciprocal exchange in Philippine interpersonal relationships. This often creates a greater feeling of mutual obligation than might result from a narrowly utilitarian relationship (Torres 1983).

Credit-marketing tie-up. Fixed productive assets are scarce in the rural areas. The small rice farmer generally has very little capital for investment and operating expenses. The majority of farmers therefore turn to credit institutions (formal and informal) to finance their operations.

Thus, when credit is needed, farmers tend to turn to informal sources such as traders (mostly Chinese businessmen) whose importance in the credit market tends to parallel their importance in commerce in general. Trust and keeping one's word of honour ('palabra de honor') are the rules followed rather than legal documents establishing claims on one another. When credit is extended in whatever form, contract enforcement is based on face-to-face sanctions. Failure to repay results in a compromised business reputation which often excludes the possibility of being able to obtain future credit.

A TBAC (1981) study which documented rural financial market trends in three provinces of the Philippines reported that informal credit sources seem to have picked up farmer-borrowers disqualified from low-cost, supervised credit programs due to repayment delinquencies. As a result of the competition between informal credit sources and the expanded formal credit delivery system which accompanied modern rice technology, effective interest rates were lowered. Moreover, the composition of informal credit sources has also been altered with the entry into the market of input dealers, progressive farmers, and multi-enterprise output buyers—apparently by-products of the new seed-fertiliser technology. The study likewise noted that the integration of product markets with the credit market significantly lowered all components of the interest rate (opportunity cost of loanable funds, administrative cost, and risk premium). Moneylending was thus relegated into a minor enterprise and with the diversification, informal credit sources linked to marketing and other activities were able to charge relatively lower interest rates which were shown to contain no substantive element of monopoly profit.

Serrano (1983), had a similar observation in his study of linked credit in Camarines Sur. He noted that the enterprise activities of lenders vary from simple output buyers who provide cash and

TABLE 6. Profile of 10 sample lenders, Baao, Camarines Sur, Philippines, 1980-81.

Item	Traders					Farmer- employer	Money lenders				
	#1	#2	#3	#4	#5	#6	#7	#8	#9	#10	
Number of business enterprises or sources of income:	7	2	7	3	8	2	7	4	4	2	
Line of business/source of income:						Years in operation					
Paddy trading	25	18	2	4	15	—	—	—	—	—	
Rice milling	25	—	2	—	15	—	—	—	—	—	
Copra trading	5	—	—	4	15	—	—	—	—	—	
Input dealership ^a	5	—	1	—	10	—	—	—	—	—	
General merchandise	20	19	4	—	20	—	—	—	—	—	
Crop farming	10	—	3	—	—	12	—	16	6	—	
Livestock farming	—	—	8	—	7	—	10	—	—	—	
Landlord	15	—	—	10	15	—	—	—	—	—	
Money lending	—	—	—	—	—	—	15	15	4	20	
Government employment	—	—	—	—	—	—	16	—	—	50	
Government pension	—	—	—	—	—	—	—	—	—	—	
Remittances from relative/ children abroad	—	—	—	—	—	—	—	—	—	—	
Others	—	—	16	—	10	10	—	—	—	—	
Sales volume/gross income (pesos 000) ^b	3364	2779	14321	948	7679	101	42	21	23	36	
Total number of client-borrowers	200	110	450	262	630	15	33	15	5	150	
Total volume of loans granted (pesos 000)	30	55	140	47	219	5	10	15	8	21	
Usual type of credit arrangement ^c	trader's (linked) credit					credit linked to labour (employer's credit)	cash (unsecured)	credit (secured & unsecured)	Interest in paddy (secured or mortgage type)	(secured or unsecured)	(secured or unsecured)

Source: Serrano (1983)

^aNone of the traders who sell intermediate inputs is a franchised input dealer and therefore they are of the unlicensed types (colorum).

^bGross sales/income from all sources (estimated). During September 1986, 20 Philippine pesos = US\$1.

^cSee section of text on types of credit arrangements for detailed descriptions.

TABLE 7. Sources of loans by type of credit arrangement, 28 households, 2 villages, Baao, Camarines Sur, Philippines, 1980-81.

Type of credit arrangement	Number of loan sources lenders ^a	Percentage of total no. of lenders	Number of households reporting ^a	Percentage of total households
I. Formal loans	4	6	8	29
A. Supervised credit	2	3	4	14
B. Non-supervised credit	3	5	4	14
II. Informal loans	63	95	28	100
A. Unlinked types	54	81	28	100
1. Non-commercial ^b	17	25	15	54
2. Storeowner's credit ^c	2	3	3	11
3. Traditional & variants ^d	31	46	21	75
4. Mortgage	4	6	6	21
B. Linked types	9	13	28	100
1. Trader's credit	8	12	25	89
2. Employer's credit	1	2	3	11

Sources: Serrano (1983).

^aFigures are not additive as some lenders provided more than one type of credit arrangement.

^bNon-commercial loans are those for which borrowers claimed no interest. Sources of such loans include friends, neighbours, and relatives.

^cLoans in kind (grocery items) from small village stores locally known as 'sari-sari' stores.

^dThis group of informal loans include takipan, talindua, terciahan, five-six, hulugan, and other variants (see TBAC (1981) and section of text on types of credit arrangements).

subsistence (mainly rice) credit to providing a more or less complete range of goods and services from cash credit, milling, intermediate inputs, groceries, dry goods, and rice trading, to hardware items (Table 6). It is important to note that none of the lenders who provided linked credit reported moneylending as a business enterprise or an important source of income.

Credit-marketing tie-up ('linking') provides at least two advantages to the lender. First, the lender has a comparative advantage in lending over other sources, primarily arising from better information regarding the borrower who is also a client in related transactions. Second, linking effectively spreads the common cost of risk and/or monitoring for all relevant transactions thereby increasing profits rather than simply maximising interest income from lending operations. By substituting subsistence items, inputs, and other commodities for the higher opportunity cost cash loans, the traders have assured themselves of a safe and more or less stable market for such items. Moreover, the traders' credit provision of 'repay after harvest by selling produce' proves an effective insurance not only against default/delinquencies but also ensures a safe supply level of paddy during postharvest periods when market competition becomes more intense.

On the other hand, the interlinkage of credit with marketing and other transactions enables the

borrower to access not only a reliable source of credit which would otherwise be either unavailable or relatively costly but also a reliable source of inputs and a buyer of output. Linking also provides the borrower with a financial technology flexible enough to overcome barriers to credit expansion.

The study by Serrano also showed that farmers do not seem to be confined to a single lender or trader but patronise others, including those outside their villages (Table 7). Borrowers allocate marketable surplus among the traders according to the sizes of outstanding loans, degree of familiarity/relation, the borrower's valuation of the 'utang na boot' (debt of gratitude) and, most importantly, the price offered for produce sold.

Among the different credit sources reported, traders appear to be the most prevalent source of linked (tie-up) credit (Table 8). They include the 'off-and-on' traders who are small-time buyers operating only during peak harvest periods. Some act as 'branch agents' of the major traders in and out of town who finance them. In the trader's lending scheme, the farmer is provided with cash and commodity loans when needed. In return, it is expected that a sufficient proportion (if not all) of the farmer's marketable surplus will be sold to the traders at the current market price.

Another type of linked credit is loans tied to the labour supplied by landless workers to big farmer-

TABLE 8. Credit commitments of 28 households by type of credit arrangement, 2 villages, Baa0, Camarines Sur, Philippines, 1980-81.

Type of credit arrangement	Percentage of total no. of loans (274)	Percentage of total volume (Pesos 124 007 ^a)	Average loan size (Pesos/loan)	
			Mean	Mode
I. Formal loans	4	26	2917	≥ 2000
A. Supervised	3	14	2539	≥ 2000
B. Non-supervised credit	1	12	3579	≥ 2000
II. Informal loans	96	74	350	≤ 100
A. Unlinked types	35	33	428	≤ 100
1. Non-commercial	15	3	79	≤ 50
2. Storeowner's credit	3	<1	25	≤ 50
3. Traditional & variants	14	18	572	301-500
4. Mortgage	3	12	2186	901-1000
B. Linked types	61	41	304	≤ 100
1. Trader's credit	54	41	342	101-300
a. cash	11	11	441	≤ 100
b. intermediate inputs	10	14	607	201-400
c. subsistence	20	12	269	≤ 100
d. cash (tenants) ^b	6	2	183	≤ 100
e. intermediate inputs (tenants) ^b	1	1	305	201-400
f. subsistence (tenant) ^b	6	1	85	≤ 100
2. Employer's credit	7	<1	27	≤ 50
ALL TYPES	-	-	453	≤ 100

Source: Serrano (1983).

^aDuring September 1986, 20 Philippine pesos = US\$1.

^bWhen the borrower is also a share-tenant or trader (5 cases).

employers. Loans are treated as cash advances by the lender, and the landless worker's labour service is tied to the employer-lender's farm operations.

The next group of lenders are the real moneylenders who provide 'porciento' (traditional and variants) or interest loans. The main feature of these loans is the 'repayment after harvest' clause, which in the case of farmers varies from one to eight months depending on the agreed repayment period. Arrangements regarding interest payments depend on two main factors: size of loan and the degree of familiarity/relationship between borrower and lender.

Another important type of credit arrangement, undoubtedly with the largest number of participants but seldom documented, is that occurring among relatives, friends, and neighbours. Non-commercial loans of this type are generally small (less than P50⁶) and short term (one week to one month), and do not carry any explicit interest rate. More common among the low-income households, the arrangement is generally not considered as debt by either party, but as a manifestation of reciprocity and mutual assistance among rural residents.

Small, all-purpose ('sari-sari') stores that dot every street corner in the village were also reported to provide small item credit to regular patrons or clients ('suki'). They are mostly non-cash loans which must be repaid within a relatively short period of time — commonly a week. Each client-borrower has a credit ceiling within a specified time period. When the ceiling is reached, more credit can be obtained only by repaying all outstanding accounts at the end of the week. While these arrangements carry no explicit interest rates, it is generally known that prices of items on credit exceed regular retail prices.

Technical Issues

Facility Design and Construction

Defects in the design and construction of processing facilities will probably result in inefficiencies (technical and economic) in its performance

In terms of mechanical dryers, Efferson and Sengelmann (1969) noted that practically all of the dryers had not been equipped with adjoining holding tanks and mechanical bulk-moving equipment to permit true multipass drying. Moreover, some of the dryers visited were in reality designed for corn and not rice. The attempt to do two different jobs with the same equipment was not particularly successful.

In the case of bulk-handling/storage systems, there is a dearth of information on the different factors affecting bulk stored grains under humid, tropical conditions. Studies on bulk handling and storage have been conducted mainly in temperate, developed countries. Therefore, there is a need to know the storage and handling parameters that will maintain good quality of grain under humid conditions. The impact or implications of bulk handling adoption on the other areas of the handling/marketing system should likewise be critically assessed (Picar 1986).

Operation and Management

Inadequate knowledge about the proper operation and management of the processing equipment and/or facilities has been identified as one of the major factors contributing to the failure of such endeavours (DCCD 1968; Weitz-Hettelsater 1968; Efferson and Sengelmann 1969; Drilon 1969; de Padua 1977). Thus, the viability of the new processing installations would largely depend upon the management of their operations. The complexity of such systems requires more sophisticated skills than have so far been available to the rice processing industry. Moreover, since most of this equipment and/or facilities relies on technologies developed under the temperate climatic conditions of developed countries, some modifications and/or changes are probably required to adapt it to humid, tropical conditions.

In the case of mechanical dryers, it has been observed that continuous-flow dryers designed to dry the grain in stages and therefore requiring tempering bins are used improperly. These dryers are often erected without the tempering bins and used at higher operating temperatures as one-pass dryers. The end result is high percentages of broken grains (Efferson and Sengelmann 1969; de Padua 1977).

The problems encountered with bulk storage of rice were also due to mistakes in management and not to the system itself (Chikubu 1970). The most frequent problem has been losses due to germination or fermentation in storage, because the paddy was not properly dried. Other losses have occurred because hot spots developed in the bulk grain or insect attacks occurred and were not found soon enough to enable proper control measures to be taken. Unlike sack (package) storage, the airtight conditions in bulk storage necessitate that paddy be uniform, well-dried, and cleaned.

Bulk storage may make sense from a capacity utilisation point of view where length of storage may call for minimising losses in long-term storages and where handling facilities may prove more effective for bulk vertical storage. Flat storage, on the other

⁶ During September 1986, 20 Philippine pesos = US\$1.

hand, may make more sense in the private trading sector where the scale of operation is likely to be smaller, turnover high and multipurpose storage facilities necessary. If one considers the Philippines grain trade, which is characterised by a large number of varieties that often must be kept separate to cater to consumer preferences, flat storage is much more suitable than silos. Moreover, flat storage allows multipurpose use (which fits perfectly into the diverse business operations of trader-miller) as compared with silos, which must be used for storing a single type of grain at a time.

Location of Processing Facilities

The economics of the country's rice handling and processing industry could be improved considerably if the locational distribution of the processing plants were aligned to the regional patterns of production and consumption. Part of the problem in the installation of integrated processing complexes is the issue of optimum location. This can be attributed to the absence of serious effort to assess the production-consumption relationship and the patterns in the movement of paddy/rice supply and their socioeconomic ramifications, in order to provide direction to what might be considered as a national program to develop an adequate and well-located processing/handling system. Private enterprise has virtually been left to itself in the problem of setting up processing plants and it has tried to solve the problem on an individual organisation basis (DCCD 1968). Three major cost components need to be considered in the optimum location of plant, over and above the initial investment in the processing/handling facilities. These are the procurement cost of the raw material used, processing costs, and distribution costs of the finished product. Procurement costs may be minimised by moving to the source of the raw materials; distribution costs by moving to the market of the finished product; and processing costs by locating in a place where the least cost combination of factor-inputs is available. All these considerations, however, may not be present at any given time and place. Hence, the optimum location will involve balancing the relative advantages of these considerations for each potential production point (Torres 1983).

Supply of Adequate Uniform (Clean/Dry) Paddy

One of the major problems cited in the failure of large milling complexes is the inadequate supply of uniform paddy to run the processing plant (dryer, mills, and/or warehouses) at full capacity for an extended period of time. This is partly attributable to the situation in which rice is grown on a large number of small-sized farms, most of them either

tenanted or leased (see Table 1). Marketing problems therefore tend to increase because small-farm sizes will require paddy traders to collect miniscule surpluses from individual farms and accumulate them for sale to other middlemen or to rice mills (Mears et al. 1974). The problem is further compounded by the large number of varieties of paddy disposed in the market. In this situation, the processing industry will have difficulty in ensuring quality control of the product due to the varied physicochemical characteristics of the different rice varieties.

Another major constraint in the efficient operation of the handling/processing sector is a reliable flow of sufficient paddy. This determines the degree to which the full engineering capacity and economic efficiency of the processing plant is attained. A common problem of the rice processing industry in the Philippines is the under-utilisation of the technical potential or installed capacity of processing plants. Many empirical studies refer to this problem as 'excess capacity'. However, according to Barker (1980), it would be incorrect to conclude that such excess capacity is a sign of inefficiency. Seasonal variation in production and in demand for processing services is one obvious reason for excess capacity.

Government Policies and Programs

The influence of government incentives, regulatory measures, pricing policies, and price stabilisation strategies in the rice industry directly or indirectly affect the growth and development of the processing industry. The role of the government is essentially to stimulate, assist, and encourage private enterprise through policy instruments and incentive programs that provide a generally favourable climate for the conduct of rice post-production activities.

Government Procurement/Distribution

During the 1960s, the role of the government through its marketing agency, the Rice and Corn Administration (RCA), was primarily the disbursement of imports in urban areas. Domestic government procurements were small, amounting only to less than 2% of production. Government procurement started to increase significantly when RCA was replaced by the National Grains Authority (NGA) in 1972, subsequently renamed the National Food Authority (NFA) in 1981. Procurement increased about fourfold between the mid and late 1970s, and then levelled off in the early 1980s (Table 9).

One major problem that constrains effective government intervention in rice marketing is its scope of operations. The NFA's problem lies in the

limited funds of the government and the fact that it only controls a small portion of paddy production in the market.

As shown in Table 9, the proportion of procurement to total production averaged 1.96% in 1974-76, increased to 7.96% in 1977-80, and declined slightly to 7.47% in 1981-83 (Lantican and Unnevehr 1985). This rate is below the mandatory 10 to 15% of total production. In terms of disbursement as percentage of rice consumption, the average figure was 3.68% in 1974-76, 3.48% in 1977-80, and 8.75% in 1981-83.

A comparison of actual paddy procurement and production levels shows that, except in Southern Mindanao (1982) and Cagayan Valley (1983), NFA did not attain its procurement target of about 15% of total production, which is considered necessary to create an attractive market for farmers. There seem to be certain limits to the volume NFA can procure, due partly to the quality standards applied and the mode of payment (higher amounts only by cheque, to be cashed at a bank office, often far away from the farmer's home). Another reason may be the recent shortage of funds available for grain purchases. However, the most important obstacle to NFA procurement is the ties and commitments binding the farmer to a trader and/or miller.

Loan Arrangement (Tied Aid)

Most of the improvements in the rice processing industry have been achieved through loans and aid programs from international funding institutions and donor agencies. Such grants or aid have enabled the government to improve and/or modernise its postproduction facilities. However, a number of these modernisation schemes did not succeed, partly

because the technology and/or equipment they involved were not appropriate or suited to the conditions in the country.

Tied aid programs generally lead to a disincentive to the selection of appropriate technology, since what is available is often limited to that preferred by the donor institution or country. Thus, tied aid not only reduces the freedom of the recipient country to choose the most suitable equipment available in various countries, but even more fundamentally it may distort the aid project in the direction of greater capital intensity (Singer 1982). A major drawback in the establishment of appropriate technologies is the fact that aid is normally not available for the recurring costs of existing projects but only for 'new projects'. Tied aid puts a premium on the developing countries to maximise the use of imported equipment (which does attract aid) and to minimise on local employment, the use of local materials, and other local cost items (which do not attract aid).

References

- Aspiras, R.A. 1969. The relationship between quality and price in Philippine wholesale rice. Presented at Seminar on consumption and marketing of rice in the Philippines, International Rice Research Institute. December 1969, Los Baños, Laguna.
- Barker, R. 1980. Rice marketing in Asia: implications for research on rice based cropping systems. Presented at the Special international symposium on rice research strategies for the future, April 21-25, International Rice Research Institute. April 1980, Los Baños, Laguna.
- Chikubu, Shinjiro, 1970. Storage condition and storage method. In: Training in storage and preservation of food grains. Tokyo, Agricultural Productivity Organization,

TABLE 9. Comparison between regional rice disbursement as percentage of regional rice consumption (average per capita consumption \times population) and regional procurement as percentage of regional production in the Philippines, selected crop years.

Region	1974-76		1977-80		1981-83	
	Proportion of procurement	Proportion of disbursement	Proportion of procurement	Proportion of disbursement	Proportion of procurement	Proportion of disbursement
Metro Manila	-	13.28	-	8.00	-	10.00
Ilocos Region	1.15	3.90	4.18	3.14	5.49	3.86
Cagayan Valley	1.06	0.68	9.52	1.24	10.77	6.48
Central Luzon	3.63	2.26	9.32	4.55	6.92	4.46
Southern Tagalog	1.57	1.71	5.01	2.58	8.84	5.73
Bicol Region	1.39	2.40	3.92	1.96	5.14	12.03
Western Visayas	1.85	0.95	7.27	1.79	5.38	6.00
Central Visayas	0.52	4.56	1.32	3.18	0.73	20.69
Eastern Visayas	2.20	4.20	5.60	3.24	3.87	11.71
Western Mindanao	2.37	6.34	5.22	3.69	6.53	13.38
Northern Mindanao	4.09	3.48	10.14	4.04	6.88	15.14
Southern Mindanao	2.24	1.50	18.55	2.82	14.95	11.82
Central Mindanao	1.64	1.45	11.86	3.02	10.15	12.93
Philippines	1.96	3.68	7.96	3.48	7.47	8.75

Sources: National Food Authority and National Census and Statistics Office.

- 109-136.
- Coloma, O.A. 1969. A multi-stage and multi-period LP transshipment model of the palay/rice trade pattern in the Philippines. Presented at Seminar on consumption and marketing of rice in the Philippines, International Rice Research Institute. December 1969, Manila.
- David, C.C. 1983. Government politics and farm mechanisation in the Philippines. Presented at the Workshop on consequences of small farm mechanisation in the Philippines. December 1983, Tagaytay.
- DCCD (DCCD Engineering Corporation). 1968. Marketing and engineering aspects of terminal warehousing for rice in the Philippines. Prepared for the Rice and Corn Administration of the Philippines. May 1968, Manila.
- de Padua, D. 1977. A critical review of the losses in rice post-production system in some Southeast Asian countries. Presented in a Workshop on interfaces between agriculture, nutrition and food science, International Rice Research Institute. February 1977, Los Baños, Laguna.
- Drilon, J.D. Jr. 1969. Modernisation of storage, drying, and milling. Presented at the Seminar on consumption and marketing of rice in the Philippines, International Rice Research Institute, December 1969, Los Baños, Laguna.
- Efferson, J.N., and K. Sengemann. 1969. An appraisal of rice drying, storage, processing, and marketing in the Philippines. Manila, The Ford Foundation, 63 p.
- Hamburgplan (Hamburgplan Architects and Engineers). 1985. Sector and feasibility study for processing, handling and storage facilities for grain. Hamburg, Hamburgplan Architects and Engineers, 288 p.
- Lantican, F.A., and Unnevehr, L.J. 1986. Rice pricing and marketing policy. Los Baños, University of the Philippines, Center for Policy and Development Studies, Working Paper No. 85-02, 47 p.
- Mathur, P.N., and Ezekiel, H. 1961. Marketable surplus of food and price fluctuations in a developing economy. *Kyklos*, 14, 396-406.
- Mears, L.A., Agabin, M.H., Anden, T.L. and Marquez, R.C. 1974. Rice economy of the Philippines. Quezon City, University of the Philippines Press, 435 p.
- Picar, G. 1986. The Philippine grain post-production industry: issues and problems. Presented at the 32nd PAEDA annual convention on multisectoral approach for agricultural development. June 1986, Pasig, Metro Manila.
- Serrano, S.R. 1983. The economics of linking credit to other markets in Camarines Sur, Bicol Region, Philippines. Los Baños, University of the Philippines, M.Sc. thesis.
- Singer, H. 1982. Technologies for basic needs. Geneva, International Labor Office, 161 p.
- TBAC (Technical Board for Agricultural Credit). 1981. A study on the informal rural financial markets in three selected provinces in the Philippines. Manila, Technical Board for Agricultural Credit.
- Toquero, Z.F., and Duff, B. 1974. Survey of post-production practices among rice farmers in Central Luzon. Presented at Saturday seminar, International Rice Research Institute. 7 September 1974, Los Baños, Laguna.
- Toquero, Z.F., Duff, B., Anden, T., and Hayami, Y. 1975. Marketable surplus functions for a subsistence crop: rice in the Philippines. *American Journal of Agricultural Economics* 57, 705-709.
- Toquero, Z.F., Maranan, C., Ebron, L., and Duff, B. 1977. Assessing quantitative and qualitative losses in rice post-production systems. IRRRI Agricultural Engineering Department Paper No. 77-01.
- Torres, E.B. 1983. Dimensions of agricultural marketing: Philippine setting. Los Baños, University of the Philippines Development Foundation Inc.
- Unnevehr, L.J. 1983. The effect and cost of Philippine government intervention in rice markets. Rice Policies in Southeast Asia Project (a joint project of the International Food Policy Research Institute, the International Rice Research Institute, and the International Fertilizer Development Center), Working Paper No. 9.
- U.S. National Academy of Sciences. 1978. Postharvest food losses in developing countries. Washington, D.C. Weitz-Hettelsater Engineers. 1968. Storage, handling and marketing of selected crops in the Republic of the Philippines. Kansas City, Missouri, Weitz-Hettelsater Engineers, 384 p.

Returns from Maintaining Product Quality in the Malaysian Rice Processing System

T.A. Chew and R.A. Ghaffar *

Abstract

This paper highlights government policies that have effects, either intended or inadvertent, on product quality at various points in the Malaysian rice processing system. Where possible, some crude estimates of the 'costs' of such policies are given and their implications discussed.

By 'product quality' we mean the multitude of physical and chemical properties which characterise a product, plus (where the product is a personal service) the personal properties of the person providing it (Brems 1948). While there are many studies on technical and engineering aspects of paddy quality (see Teter et al. 1983), economic studies are rare (see Ladd 1978). The basic principle in economics is that product quality becomes important if there exists an optimum quality distribution from a range of feasible qualities of a single product when costs as well as revenue effects of product quality variations are taken into account. In this paper, government policies which have effects on product quality, either intended or inadvertent, at different points in the Malaysian paddy/rice processing system are highlighted. Some crude estimates of the 'costs' of these government policies are given, where approximations can be made. The implications for policy are discussed, in the context of technological change.

The Malaysian Paddy/Rice Processing System

The Malaysian paddy/rice processing system is depicted in Figure 1. Farmers sell their paddy to private or LPN¹ complexes, either directly or

through licensed LPN agents. Which route a farmer chooses to sell his product depends on a comparative evaluation of the cost and returns of his using the different possible paths. The costs incurred by farmers in disposing of their product comprise packing costs, transportation costs, queuing costs, and penalty costs for moisture in paddy.

The three broad areas in the Malaysian paddy/rice processing system (Fig. 1) where government

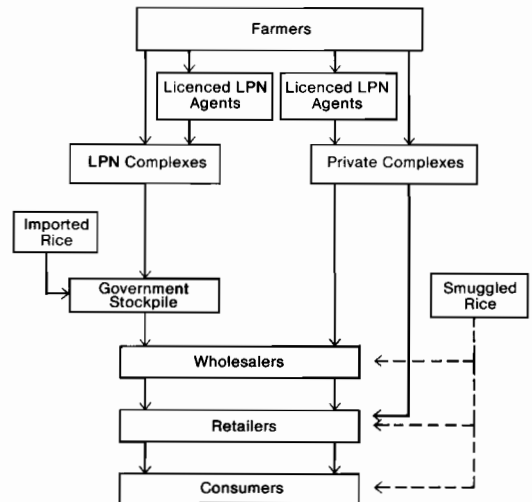

Note: The routes for smuggled rice are authors' speculation only.

Fig. 1. Schematic of the Malaysian paddy/rice processing system. (Note: The routes for smuggled rice are speculative.)

¹ Lembaga Padi dan Beras Negara (National Paddy and Rice Authority), a government statutory body.

* Faculty of Resource Economics and Agri-business, Universiti Pertanian Malaysia, 43400 Serdang, Selangor, Malaysia.

policies affect product quality are:

(i) Paddy input stage — government paddy purchasing policy: this refers to government net prices offered for paddy of different qualities, grades, and moisture contents. Paddy coming into the government paddy processing system is graded for immature grain, debris and other impurities, and level of moisture content. The farmer is paid an appropriate price after weight deductions are made for impurities and moisture content. The effect of government paddy grading and pricing policy is critical in the sense that as paddy flows through the private system vis-à-vis government complexes are affected. All subsequent events, such as storage, drying, and milling of paddy, and the influences of these operations on product quality, can be related to the initial government buying system.

(ii) Paddy-to-rice transformation stage — government policy with regard to paddy/rice complex operation: the siting of the complexes, their engineering characteristics, the managerial qualities of the key personnel involved, and the underlying paradigm used in the operation of these government mills, all have a bearing on the efficiency of the paddy-to-rice transformation

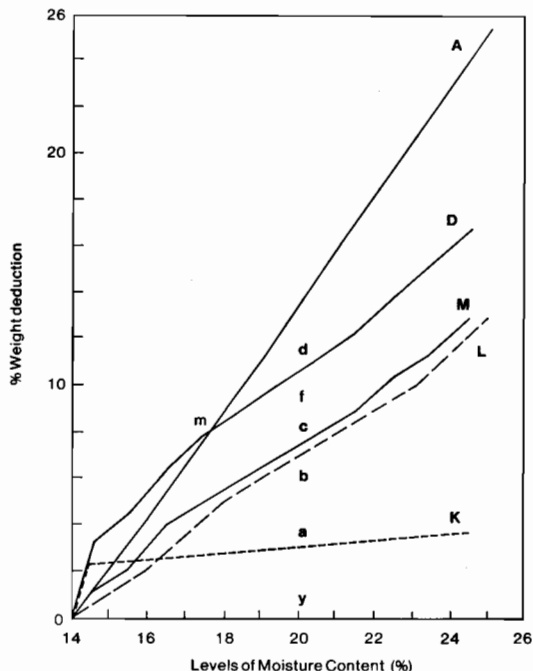

- A Average of deductions for Thailand, Philippines and Indonesia
- D Appropriate deduction rate for Malaysia
- M Current deduction rate in Malaysia
- L Weight shrinkage
- K Cost of drying

Fig. 2. Actual weight reduction rate versus moisture content and appropriate reduction rate for Malaysia, 1985.

process and the quality of rice produced.

(iii) Rice output distribution stage — government policy with regard to grading, pricing, and stockpiling of rice: This is the final stage in the processing chain. A complicating factor here is the extensive smuggling of rice into the country.

The policies in all three areas are interrelated and involve many issues. To keep this paper within limits, we shall treat the policies separately and touch only on selected areas.

Paddy Input Stage

As measurements of paddy quality, paddy type, impurities (including immature grains), and moisture content in paddy are used — the idea being to 'standardise' paddy so that a uniform price can be paid for paddy of different qualities. Not much can be said about government weight deductions for impurities, as to whether such deductions are excessive compared with private millers, because impurities are separable and can be deducted out of the final weight of paddy. In the LPN system, though, the cost of removal of impurities is borne by LPN, because paddy with 1% impurities is deducted exactly 1% in final weight. (Obviously private millers must 'estimate' a figure of more than 1% impurities and deduct accordingly to recover the cost of removal). There is nothing much in the literature on this matter.

It is in regard to weight deductions for moisture in paddy that controversy arises. Unlike impurities, moisture in paddy is impossible to isolate and measure separately. Further, when a load of paddy is dried, moisture is driven out and there is shrinkage in final paddy weight. This shrinkage factor must be taken into consideration in any deduction rule for moisture. In an earlier paper (Chew and Fatimah 1986), it was argued that the Malaysian deduction for paddy moisture is the most lenient among the ASEAN countries and, unfortunately, does not cover the cost of removal of moisture. As shown in Figure 2, reproduced from the earlier paper, the current Malaysian moisture deduction rule (M) is only slightly greater than the weight shrinkage factor (L), so that farmers gain a 'hidden' subsidy of (fc) from *not* drying their product. The subsequent effects and costs on the government paddy complex system are profound. Government complexes are deluged with wet paddy, queues build up, and paddy deterioration results from delays, as farmers gain from selling to government complexes compared with selling to private millers, especially in the wet season.

Technological and engineering considerations in the art of storage, drying, and milling become secondary in the face of these pervasive effects of the price mechanism in the processing system. The

TABLE 1. Deductions for paddy moisture in government and private rice complexes in Malaysia.

Season	Government complexes				Private complexes			
	84/I	84/II	85/I	85/II	84/I	84/II	85/I	85/II
No. of observations	599	649	656	650	100	97	98	97
Mean deductions (%)	8.62 (1.98)	10.62 (3.33)	7.71 (3.02)	9.58 (3.67)	10.78 (2.98)	13.77 (4.20)	13.63 (2.95)	15.53 (3.46)

Note: numbers in parentheses are standard deviations.

cost of running an LPN complex is consequently large: about 1 million dollars per year subsidy is needed to operate an average-sized LPN complex².

It is instructive to estimate the 'hidden' subsidy that farmers gain from not drying. Assuming a conservative figure of M\$5 per tonne (during September 1986, 2.6 Malaysian ringgit = US\$1) for (fc) in Figure 2 (where db = M\$20/xx), and assuming that government complexes produce about 0.35 million tonnes of rice per year (or its equivalent of 0.54 million tonnes of paddy), the 'hidden' subsidy is equal to about M\$2.7 million.

We have collected data on moisture deductions in private complexes for comparison with values for government complexes (Table 1). It is considerably harder to collect data from private complexes, as owners are not keen to divulge such information — hence the much lower number of observations for private millers. The data show that deductions for moisture in private complexes are higher than government deductions, by 2.1%, 3.15%, 5.92%, and 5.95% for 1984 first and second and 1985 first and second seasons, respectively, all significant at the 5% level. This is to be expected, as private millers must recover the cost of drying.

Paddy-to-Rice Transformation Stage

There is no documented information as to how government complexes are supposed to operate. However, it is generally understood that complex managers are expected to minimise monetary losses. It is accepted that with current paddy purchasing policies and rice output prices, it is not possible for LPN complexes to show profits. There is therefore a distinct difference in the paradigm of operation between government complexes and private establishments. The latter have to show a profit in order to remain in business. Given this difference in the underlying paradigm of operation, one naturally expects the rice produced by private millers to be of better quality than that produced by LPN complexes. We tested this hypothesis by comparing the grades of rice produced by private millers with

grades produced by LPN complexes. In the Malaysian rice grading system, the 'good' grades are A1, A2, B1, and B2. The 'middle' grades are A3, A4, B3, and B4. The 'bad' grades are sample rice and broken designated as S and D. We compared the percentage composition, in terms of percentages of various grades, for government and private establishments. The results (Table 2) show that private complexes produce significantly more of the 'good' grades, such as A1 and B1, and less of the 'middle' grades, such as A3, A4, B3, B4, than government mills. The 'bad' grades are about the same, as D and S are more or less interchangeable with each other. (The combined total S and D is slightly more in government mills compared with private mills: 22.69% against 19.94%). We can thus conclude that our hypothesis that private mills generally produce better quality grades of rice compared with government mills is confirmed³.

Rice Output Distribution Stage

There is no published information on government rice pricing and rice stockpile policies. Thus, the rationale behind the prices fixed for the various grades of rice is not known. For example, A1 price is fixed at \$92.51 per 100 kg, while A2, A3 and A4 are priced at \$84.30, \$76.08, and \$61.88. Is the quality difference between A1 and A2 consistent with the difference in price? Some hedonic index-type study (Morgan et al. 1979) on the identification and pricing of the bundle of characteristics that make up quality in rice is necessary to answer this and related questions.

LPN currently keeps some 260–300 000 tonnes of rice in stockpile, equivalent to 3 months supply for

² This is our rough estimate and may be excessive. However, the heavy cost of LPN complexes to society is undoubted.

³ Given the social role in alleviating rural poverty that LPN is supposed to play, any conclusion otherwise would be most surprising. LPN is the paddy buyer of last resort and cannot reject any paddy brought in by farmers, regardless of its quality. Thus, one can generally say that LPN has poorer quality paddy to start with and cannot control the quantity of paddy as well (paddy buyer of last resort), compared with private millers. Given the telescoping of the harvesting period into a short time, a large build-up of wet paddy in a short time poses great problems for the drying capacity in LPN complexes.

TABLE 2. Grades of rice produced by private and government complexes in Malaysia.

Grades	Private mills	Government mills	t-values ^a ($\bar{P}_g - \bar{G}_g$)/S.E.
	\bar{P}_g (n = 16)	\bar{G}_g (n = 36)	
A1	11.00% (0.043)	3.72% (0.007)	2.92*
A2	4.50% (0.018)	11.86% (0.007)	-1.56
B1	28.75% (0.112)	3.94% (0.005)	4.89*
B2	31.06% (0.121)	37.72% (0.016)	-1.14
A3	0.0% (0.0)	1.39% (0.003)	-2.61*
A4	0.0% (0.0)	0.92% (0.002)	-2.03*
B3	2.38% (0.009)	11.06% (0.012)	-3.36*
B4	1.31% (0.005)	8.42% (0.009)	-3.22*
S	1.44% (0.006)	13.83% (0.010)	-5.71*
D	18.50% (0.72)	8.86% (0.007)	4.54*

Notes: \bar{P}_g is mean % for particular grade of rice produced by private mills

\bar{G}_g is mean % for particular grade of rice produced by government mills.

n refers to number of sets of observations from which mean values were derived.

* Significant at 5% level.

The column totals do not add up to exactly 100% owing to rounding errors.

Peninsular Malaysia and 6 months for East Malaysia. It is estimated that about M\$28 million are tied up in the form of physical rice stocks (Tan 1986), which is costly in terms of storage costs and quality deterioration over time. Is the present cost of maintaining the stockpile tolerable? Perhaps it would be better to set aside financial assets that earn interest to provide for food security rather than maintain a large stockpile. A further complication is the extensive smuggling of rice into Malaysia because of the high local rice price compared with the border price. This makes demand for local rice uncertain. Uncertainty inhibits the private investments needed for the modernisation of the rice processing industry.

Clearly, some optimal decision rules have to be formulated for accumulation and release of stockpiles. Grading and pricing of rice have to be rationalised. Quality of rice would surely be crucial in such deliberations. Unfortunately, at this stage we have only questions and no answers.

Where Does Technological Change Fit In?

There has been considerable technological progress in the paddy postharvest sector. New, more efficient transport systems, more efficient drying and milling equipment, new storage systems, better pest management, computerised systems, and so on have been developed. All these technological improvements, which by right should bring about improvements in product quality, can come to nought in the face of ill-conceived economic policies. The moisture deduction system used by LPN is one such illustrative example. It demonstrates the overriding influence the price mechanism can have over technical-engineering issues⁴.

⁴ Preliminary results generated by a project to model bulk handling (ACIAR 1986) show that the price of paddy is about ten times more effective in changing net industry returns compared with engineering issues.

Concluding Remarks

The overall picture that emerges from this brief survey of the Malaysian paddy/rice processing industry with product quality in mind, is one of government interference in the industry in pursuit of redistributive goals⁵ favouring producers at the expense of consumers and rice processors. In this pursuit of equity aims, the efficiency goal is lost and with it product quality considerations. This is especially clear in the paddy purchasing stage, clear in the LPN-complex operation stage, and less clear, perhaps, at the rice distribution end.

⁵ Paddy farmers, rubber and coconut smallholders, and fishermen are identified as the most poverty-stricken groups in Malaysia. Malaysia's Five-Year Plans have, as one of their main thrusts, the goal of eliminating rural poverty. A number of policies, statutory bodies, and government business enterprises are designed for this purpose.

References

ACIAR. 1986. Bulk handling of paddy and rice in Malaysia. Paper presented by ACIAR Project 8344 team

- at 9th annual technical seminar on grain postharvest technology, ASEAN Crops Post-Harvest Programme. August 1986, Singapore.
- Brems, H. 1948. The interdependence of quality variations, selling effort and price. *Quarterly Journal of Economics*, 62, 418-440.
- Chew, T.A., and Fatimah Arshad. 1986. Comparative paddy pricing systems in ASEAN. Presented at 9th Annual technical seminar on grain postharvest technology, ASEAN Crops Post-Harvest Programme. August 1986, Singapore.
- Ladd, G.W. 1978. Research on product characteristics: models, applications and measures. Ames, Iowa, Iowa State University Agriculture and Home Economics Experiment Station, Bulletin 584.
- Morgan, K.J., Metzen, E.J., and Johnson, S.R. 1979. An hedonic index for breakfast cereals. *Journal of Consumer Research*, 6, 67-75.
- Tan Siew Hoey 1986. Whither the case for food security in Malaysia? Presented at National seminar on food security and policy issues, Universiti Pertanian Malaysia. July 1986, Serdang, Selangor.
- Teter, N.S., Semple, R.L., and Frio, A.S., ed. 1985. Maintaining good grain quality. Proceedings of the 6th annual workshop on grain postharvest technology, Southeast Asian Cooperative Post-Harvest Research and Development Programme. May 1983, Bogor, Indonesia, 376 p.

Economic Aspects of Postharvest Handling and Storage — Applied Studies Session Chairman's Summary

C.W. McCormac *

THE first paper in this session, presented by Dr Z. Toquero, examined the results of a study of the different variables which affect or influence the development of the grains postharvest sector in the Philippines. These variables are grouped into (a) economic, (b) sociocultural, (c) technological, and (d) government policies and programs. The author discussed: the flow of paddy/rice; the economic environment of the farmers; quality standards and grades currently used; pricing structure; and the implications of modernisation of postharvest facilities on capital/labour substitution. These and other factors prevailing during the period covered in the study limited, to an extent, the development of the grains postharvest sector. The sociocultural traits prominent among Filipinos also influence the production and postproduction system. These are evident in labour arrangements for weeding and harvesting, extension of credit facilities, and in the marketing of produce. These sociocultural traits and associated market arrangements are advantageous to both traders and farmer as they provided a guaranteed market for the farmers' produce and guaranteed repayment of debts to creditors. The paper further noted that certain technical issues, such as facility design, location, management, and supply of good quality paddy were not critically examined and considered with reference to location-specific conditions when these facilities were being planned for introduction. Government policies and programs regarding the procurement of grains introduced constraint and/or inappropriate changes in the marketing system. The paper recommends a holistic approach to analysis and consideration of all these factors when introducing programs for modernising the grains postharvest sector.

In his paper to this session, Dr Chew Tek Ann discussed two critical issues related to the quality of paddy and rice in Malaysia. These are the system of pricing and government policies on retailing and stockpiling of paddy and rice. He noted that the drying cost is not reflected in the existing paddy procurement price structure (as in most ASEAN countries) and is not adequate to cover the cost of drying and cleaning which is subsequently done by LPN and/or the private traders. As a result, there are delays and quality losses at LPN's drying facilities. As a buyer of last resort, LPN turns out poorer quality rice than the private millers. The authors recommended a review of government policies referring to grain prices and stockpiling for food security purposes to rationalise the grading and pricing systems. The improvement of grains postharvest facilities will not be as effective as might be expected, unless changes are made in pricing and grades and standards policies.

The third paper in the session (prepared by Dr J. Quilkey and presented in his absence) covered the methodology of economic appraisal of technological change. It provided an alternative approach to the economic analysis usually employed to evaluate technological innovations. He noted that economic analysis has often

* International Development Research Centre, P.O. Box 101, Tanglin, Singapore 9124.

focused only on changes or benefits on the supply side. The background of the paper, presented by Dr R. Piggot, discussed the following economic concepts:

- (i) demand — consumer surplus
- (ii) supply — producer surplus
- (iii) market equilibrium — economic benefit
- (iv) market parameters (elasticities).

Dr J. Remenyi discussed the economic model for appraisal of technological change, which provided a balanced distribution of benefits to both supply and demand sides. Further work needs to be done using this analytical approach. It appears that it would be useful in determining government priorities regarding technological innovations as well as rationalising investment in them.

Issues and Recommendations

A variety of issues was raised during discussion of the papers, most being specific to individual papers, but with a few of a general nature. It was agreed that exchange rate policy can effect capital/labour substitution. The margin between 'floor' and 'ceiling' prices set by government is a significant determinant of the type and level of investment in private grain marketing (including processing) activities and a minimum national buffer stock will likely be a continuing government policy, regardless of cost. It remains unclear whether grain cross-price relationships are considered in determining commodity specific government price policies, and whether the government allocation of funds for grain procurement is decided in part by an analysis of the opportunity cost of these funds.

Considerable discussion revolved around three questions: how are the sectors of society that benefit from a postharvest technological change identified; how are the benefits quantified; and are there other benefits besides economic ones that have to be defined and measured?

The extent of relevant identification of beneficiaries and the level of benefit are largely dependent on the nature of the economic model used. Strong arguments were put forward for the use of general rather than partial equilibrium models, in order to capture secondary as well as primary effects. The model must also disaggregate both 'producers' and 'consumers' of grain products into well identified sub-groups. Partial equilibrium models are suitable for evaluating a technological change within the sector where the change occurs, but are insufficient for determining effects on equity for society as a whole. It was clarified that economic benefits are not limited to monetary measurement but include social and political ones.

While no specific recommendations were noted in this session, the following conclusions were generally agreed upon.

1. Macro-economic analysis of national grain postharvest systems is an essential and valuable method for assigning the costs and benefits of related government policy, investment strategies, and alternative technology prescriptions.

2. Even location or site specific analysis of a grain 'system' should include a determination of the socioeconomic as well as technical feasibility of an intended technological change.

3. In Southeast Asia, research to date has shown us more clearly which specific pricing policies are or are not appropriate, as compared with which specific alternative technologies are or are not appropriate.

4. Economic methodologies for assessing technological change at both macro and micro levels need further refinement and testing.

Institutional Changes

Some Views on the Economic Appraisal of Technological Change

J.J. Quilkey and P.J. Gunawardana *

Abstract

Economic appraisal of technological change has often been limited to a consideration of changes on the supply side. Changes on the demand side have been cursorily treated or ignored. In addition, little attention has been directed to the order of the modelling process, and the disaggregation of benefits has been restricted to market levels (producers, wholesalers, retailers) rather than to sectors of the market which may have greater policy relevance, such as rich and poor consumers, or large and small producers. Neither has sufficient attention been directed to market parameters which alter concomitantly with technical change, such as the substitutability of resources, or consumer reaction to product quality as incomes change. This paper is directed to a consideration of these gaps in the analysis.

ECONOMISTS trained in the neoclassical tradition are constrained to consider problems for solution in a somewhat fixed mode. This is not necessarily a binding or damaging constraint if problem specification, hypotheses formulation, and model building are interpreted broadly. Nevertheless, there is a tendency on the part of the neoclassicist to specify problems in terms of variables rather than parameters. Unless it is clear that problems have meaning only in terms of the relationships among variables there can be no unequivocal way of integrating the planning, monitoring, and the assessment either before (*ex ante*) or after (*ex post*) the event, of strategies to alter products or processes, institutions or market performance.

Elsewhere, Quilkey (1986) has foreshadowed in the context of process and product variation rather than promotion the sequence of ideas enunciated here. *Ex ante* analysis presents an opportunity to assess the ways in which product and process design can moderate the disadvantageous effects of changes in the characteristics of demand and supply, or to enhance the beneficial effects of change. This proposition is suggestive of a proactive rather than a reactive role to both *ex ante* and *ex post* analysis.

What is often overlooked is that technical change with respect to product or process (including all

market functions) is, or can be accompanied by, a package of effects which may alter the market environment in which the producer and consumer surpluses are evaluated. An appraisal which is based merely on cost reduction at the margin derived from the proposed change may understate or overstate the achievable effects of the innovation.

The simplest possible example of this kind of myopia in analysis is where benefit/cost analysis ascribes all the benefits and costs to the research input and ignores the necessary concomitant extension of the research. Often too, the benefits of changes such as grading which improve both pricing and operational efficiency are understated (as are the accompanying costs) when attendant cumulative advantages, such as decentralised selling for which grading/classification is a necessary condition, are ignored. It is not that the succession of technical improvements cannot be accommodated in the analysis, it is rather that partiality of the analysis arises from the initial problem specification.

Such problems are exacerbated when the projected or effected change results in changes in the major market parameters, slopes or elasticities of demand or supply functions, or changes in market structure, marketing institutions, and other components of the market environment.

Because it is not possible to cover all the problems which arise in the appraisal of technical change one significant segment of the appropriate analytical

* School of Agriculture, La Trobe University, Bundoora, Victoria 3083, Australia.

path is largely ignored here. This is consideration of the general equilibrium market effects of a local innovation in product or process and their dissemination among the various components of the product market — the innovating segments, the non-innovating segments, and the total market. The appropriate analytical devices have been adequately treated by Quilkey (1970), Edwards and Freebairn (1981), and Freebairn et al. (1982). These studies take into account the distribution of costs and benefits according to market location. The analysis here is restricted in the main to closed economies. However, the comments made have application in the more general cases and may be quite simply extended to them.

One of the principal targets of economic policy in developing countries is the achievement of self-sufficiency in food. The passion for self-sufficiency is understandable as a political goal but it may also be a costly indulgence (sometimes fostered by aid agencies) for those countries for whom comparative advantage is neither currently nor prospectively consistent with policies aimed at self-sufficiency in particular commodities.

The doctrine of comparative advantage does not, however, prohibit the search for appropriate technology to moderate a perceived food imbalance. Indeed, under certain circumstances appropriate research into improved technology in the production, handling, processing, and distribution of commodities of which a country is a net importer can attract benefits of both improved social surplus and 'improved' distributional outcomes. Analysis of such situations often ignores the distributional outcomes and the focus can very easily become myopically fixed on social surplus alone.

The practicalities of centrally funded or sponsored research require that adequate attention be paid to distributional outcomes, since the losers from redistribution of social surpluses emanating from research may not be restricted to disadvantaged groups, who are the targets of legitimate policy concern. The losers may also be those who currently extract rents from the market and who will expend resources to protect them even where the benefits of research are substantial for society as a whole.

It may therefore be as important to identify the inhibitors of the adoption of new technology as it is to identify innovators and to encourage a climate in markets and institutions which is compatible with the society's technical and social objectives.

Lindner and Jarrett (1978), Rose (1980), and Alston and Scobie (1983) have devoted effort and exposition to the supply effects of varying assumptions about elasticities of substitution and the emergent parallel, divergent, and pivotal supply

functions and their attendant consequences for measures of producer surplus. These problems are difficult enough, but the implementation of an innovation strategy is further complicated by the likelihood that either demand or supply can shift stochastically for a number of reasons. It is this problem which is addressed in the next two sections.

Shifts in Demand and Changing Slopes of the Supply Function

In selecting among processes from the array of potential technological improvements, the policy maker may be concerned not only with the social benefits accruing to technical change but also with maximising advantage to consumers. If this be so and the market is subject to stochastic shifts in demand, the outcome will depend on the direction of change (if any) in the elasticity of supply following the selection and implementation of the technical change.

Consider Figure 1, in which the original equilibrium conditions are given by price P_0 and quantity Q_0 as defined by the intersection of the original demand curve DD and supply curve SS . The choice of new technology takes the form of a new equilibrium at price P_E and quantity Q_E . Depending on the selection of technique, the supply curve in the new situation may be described by the relatively inelastic supply function S^*S^* or the relatively elastic function $S^{**}S^{**}$. Social benefits are greater from the selection of the technology employing the methods represented by S^*S^* .

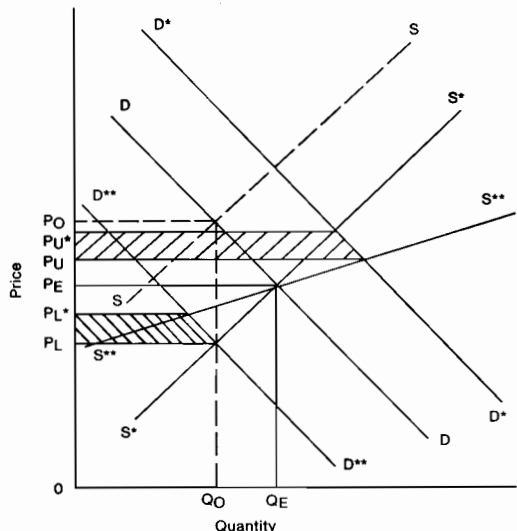

Fig. 1. Effects of demand shifts on consumer surplus when supply elasticity changes.

Given that the market is subject to demand fluctuations, or that systematic shifts in demand are equally likely events, such changes can be represented by shifts in demand from DD to either D^*D^* or $D^{**}D^{**}$.

If the shift is to D^*D^* , and S^*S^* is the selected technology, then consumers forego consumer surplus represented by the hatched area to the right of $P_uP_u^*$ compared with the situation where the technology represented by $S^{**}S^{**}$ is selected. If the shift in demand is to $D^{**}D^{**}$, and S^*S^* is the selected technology, consumers gain consumer surplus represented by the hatched area to the right of $P_lP_l^*$ compared with the situation where the technology is represented by $S^{**}S^{**}$.

Where shifts to S^*S^* or $S^{**}S^{**}$ are equally likely events, consumers would prefer the choice of $S^{**}S^{**}$, while S^*S^* would be preferred by producers since they would gain the additional surplus represented by the area between the two supply curves to the left of ZT .

If the choice of technology is for $S^{**}S^{**}$, and D^*D^* occurs, consumers benefit and producers lose. If the choice is for S^*S^* , and $D^{**}D^{**}$ occurs, producers gain from the selection and consumers lose. Hybrid functions of the kind typified by S^*S^{**} ensure that both consumer and producer surpluses improve. Similarly, functions of the type $S^{**}S^*$ reduce the gains from change for both consumers and producers. It may well be that where processes change products change and markets are segmented with respect to both supply and demand characteristics. On the supply side the shape of the

product transformation curve may alter with new technology such that the choice of the forms output will take widen or narrow and consequently the shape of the supply curve changes. Such changes are design features of altered technology and, given their impact on producer and consumer surpluses, estimates of the changes in supply characteristics which they engender are a necessary component of ex ante and ex post analysis and purposeful alteration of the process or product to achieve policy goals.

Supply Shifts and Quality Variation

The choice of process may modify the welfare outcomes for producers and consumers, given that demand can shift. Where the product's quality is enhanced by improved processing, and quality variation alters the segment of the market to which the product is directed, shifts in supply will affect the size of consumer and producer surplus. For the sake of simplicity, we will concentrate here on producer surplus.

Suppose that the technological selection is such that the product has fewer substitutes. This selection has been effective if the demand for the product becomes less elastic following the change in process. This kind of outcome is depicted in Figure 2. Following the technical change, if the product is unaltered, equilibrium occurs at the intersection of the initial demand curve and the post-technical-change supply curve (D and S) such that Q_0 is sold at price P_0 . If the process has been directed to an

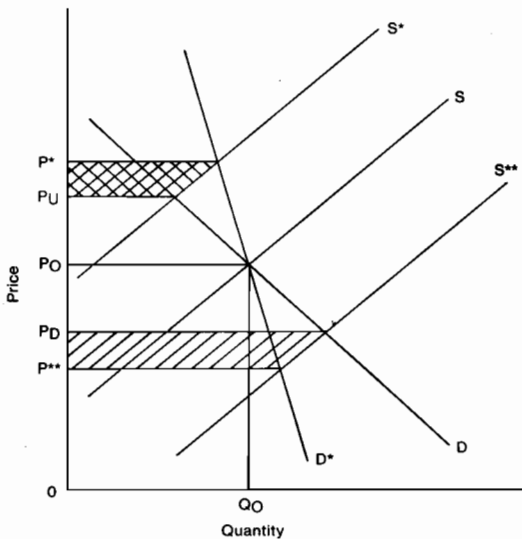

Fig. 2. Effects on producer surplus of supply shifts in markets where demand becomes less elastic due to quality changes.

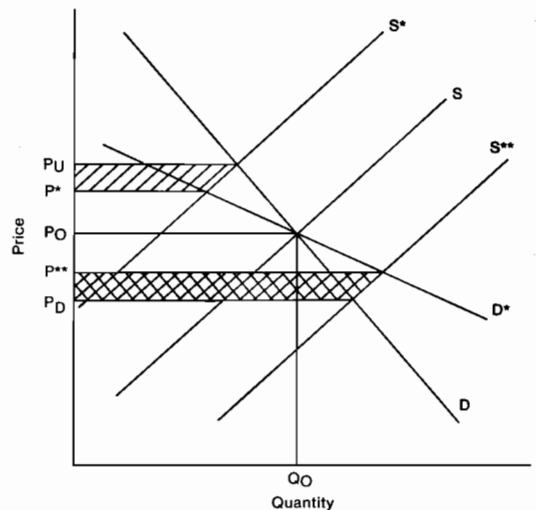

Fig. 3. Effects on producer surplus of supply shifts in markets where demand becomes more elastic due to quality changes.

alteration of the product such that it has fewer substitutes the demand function becomes less elastic, as indicated by the demand curve D^* .

Suppose that the product engineering is chosen to stress the unique characteristics of the product such that the expected outcome would be to reduce the range of its competitors. The strategy would be considered successful if, as predicted, demand for the product (around the going market price) became less elastic following the product change. Such an outcome is depicted in Figure 2. Initially, market equilibrium occurs at the intersection of the initial demand and supply curves (D and S) such that Q_0 is sold at price P_0 . Following 'successful' product change, demand for the product becomes less elastic as indicated by the post-product-variation demand curve D^* .

Let us now suppose that the supply curve shifts to the left as a result of some set of exogenous forces as indicated by S^* . Without product variation, the equilibrium price, P_u , would prevail, as opposed to an equilibrium price, P^* , with product variation. The gain from product variation in terms of producer surplus, is indicated by the cross-hatched area.

If, however, supply shifts to the right, with P_d and P^{**} as equilibrium prices in the absence and presence of product variation, producers lose the surplus indicated by the lower hatched area in Figure 2.

If S^* and S^{**} are equi-probable events and they represent symmetrical shifts in supply, the expected

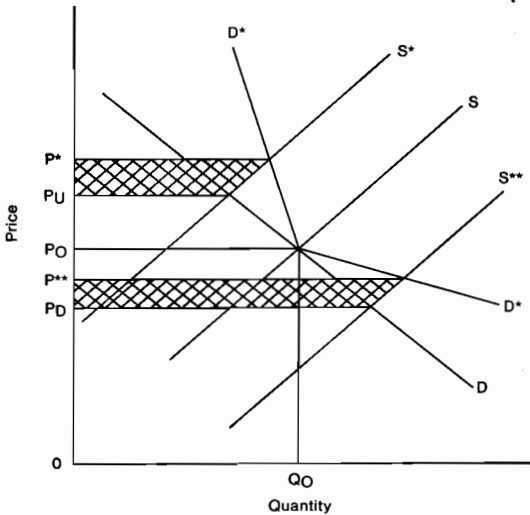

Fig. 4. Effects on producer surplus of supply shifts in markets where the effects of quality changes on demand are segmented; more elastic at lower prices and less elastic at higher prices.

outcome of the process selection is a loss to producers.

Similarly, when the selected process is geared to increasing the range of end uses of the product or otherwise increasing its substitutability for other products, the expected outcome is that the price elasticity of demand for the product will increase. Such an outcome is depicted in Figure 3. Should supply shift exogenously, as indicated by S^* or S^{**} , producer surplus is modified and, along the lines of the argument with respect to Figure 2, producers will on average gain from the strategy.

When the market is segmented as in Figure 4 — made more elastic below the current price and less elastic for prices above the current level — producers always gain. Where the reverse elasticities apply, as in Figure 5, producers always lose regardless of the direction of the supply shift.

Accounting for the incidence of supply changes, given the selected design strategy and its effect on demand elasticity, becomes a complex problem when the assumption of a single market is relaxed. Similarly, specification of the source of the supply change is necessary to identify the impact of the joint outcomes of product variation and supply changes. The incidence of producer gains or losses are not confined to the source of the supply change.

Further complications ensue when account is taken of the heterogeneity of agricultural products and the consequent multiplicity of end uses for which the outcomes of particular product variation strategies will have different consequences. The

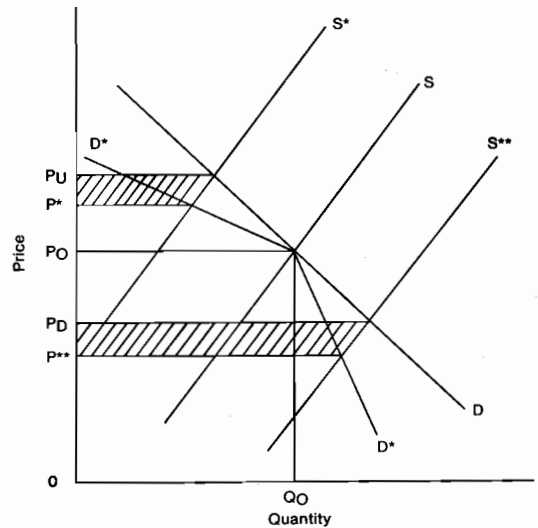

Fig. 5. Effects on producer surplus of supply shifts in markets where the effects of quality changes on demand are segmented; more elastic at higher prices and less elastic at lower prices.

effects of relative changes in supply of different grades and types of the product are similarly convoluted.

The ways in which higher cost regimes, technology, or weather find expression in the supply function will amplify or mitigate the effect shown in these simple diagrams. The problems encountered here are similar to those treated by Lindner and Jarrett (1978) and Rose (1980). To the problems which they raise of convergence and divergence of supply functions can be added those on the demand side.

Some Aspects of Food Self-Sufficiency and Technical Change

The achievement of self-sufficiency in a commodity through the domestic tax-cum-subsidy arrangements and tariffs which have persisted throughout Asia inflicts an economic burden on domestic consumers, especially low-income consumers. A country such as Indonesia would need to increase say milk output by about five times the current level to attain self-sufficiency. Alternatives in the form of research and its application are asked to perform a Herculean task to achieve this level of output. Nevertheless, gains through research and technology can be made, given some level of political commitment if not economic sense.

This has been recognised by Remenyi (1986) who examines the gains to be made through technical change. Since there are two relevant elements of the gains from research which may be drawn from his analysis they are discussed below using Remenyi's diagram reproduced here as Figure 6.

In Figure 6 the pre- and post-research domestic supply curves are shown as nS_1 and oS_2 . The demand curve is given by D , which is assumed to remain fixed. In both the pre- and post-research situations, domestic price is set at P_d . The import price, P_w , is assumed to remain fixed in both situations.

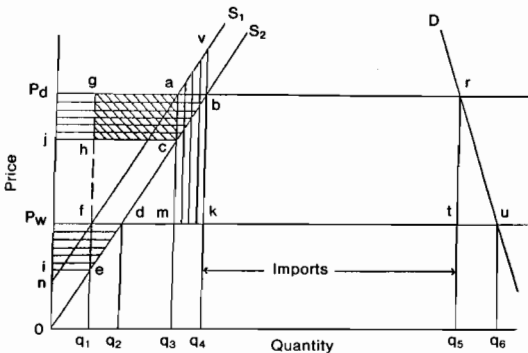

Fig. 6. Returns to research: dairying in Indonesia. Source: Remenyi (1986), Figure 2.

If we decide to take the import price (P_w) as our benchmark to evaluate the costs and benefits of the supply shift in the presence of domestic price distortion, to be consistent we must then compare the output, consumption, trade, and welfare effects on this basis.

Quantity supplied by domestic producers in the pre-research situation at the import price (P_w) is q_1 . After the supply shift, this quantity increases to q_2 . Quantity demanded at P_w remains unchanged at q_6 . Imports at P_w before and after the supply shift are given by q_1q_6 and q_2q_6 , respectively.

At the distorted domestic price (P_d), the quantities supplied before and after the supply shift are q_3 and q_4 , respectively, while the quantity demanded remains unchanged at q_5 . When P_d is the ruling price for domestic producers and consumers, imports before and after the supply shift are shown by q_3q_5 and q_4q_5 , respectively.

If the outcomes at P_w are the benchmark, then we must consider the effects of the price distortion and the supply shift together because, as illustrated in Figure 6, research leads to the supply shift in the presence of the domestic price distortion, and the supply shift does not change the distorted domestic price.

The welfare effects of the supply shift and the price distortion, compared with the outcomes at the import price (P_w), are as follows:

loss in	
consumers'	
surplus:	area P_wurP_d
gain in	
producers'	
surplus:	area $P_wdbP_d + nfdo$
social benefit:	area $nfdo + abv$
social costs:	area $dbk + tur$
net social	
benefit:	$(nfdo + abv) - (dbk + tur)$.

Area abv is the social benefit from cost savings by producing extra output q_3q_4 at P_d on the new supply curve (oS_2), instead of producing it at a higher price on the old supply curve (nS_1). Net revenue of importers after the supply shift is indicated by area ktr .

However, if we start with the situation at the domestic price (P_d) as the benchmark, the welfare effects are different. In this case, the base points for comparison are P_d , q_3 , and q_5 . After the supply shift, the only change that occurs in these variables is that the quantity supplied by domestic producers increases from q_3 to q_4 . Now, we must consider the welfare effects of the supply shift only. The welfare effects, compared with the outcomes at the domestic price (P_d) and the old supply curve nS_1 , are as follows:

gain in
 producers'
 surplus: area nabo
 social benefit: area nabo + abv.

Note that there is no change in consumers' surplus after the supply shift since neither the price faced by consumers nor the quantity demanded is altered by the change.

Thus, the social benefit (gross), measured on the basis of the import price (P_w) as the benchmark, is less by area f_{dab} than that measured on the basis of the domestic price (P_d) as the benchmark.

The foregoing discussion makes it clear that if one uses the import price (P_w) as the benchmark for the identification of research gains within the framework specified by Remenyi, one encounters both social costs of price distortions as well as social benefits of supply shifts caused by research. When comparing the outcomes of price policy and supply shift together, taking the import price (P_w) as the benchmark, the social costs of price distortions must be subtracted from the social benefit of research to obtain a measure of net social benefit of research in the presence of domestic price distortions.

On the other hand, if one uses the domestic price (P_d) as the benchmark to evaluate research gains, one encounters only social costs because this approach overlooks the effects of price distortion and takes only the supply shift into account.

Remenyi considered only a parallel shift, as did we in the foregoing discussion. In case of a non-parallel (divergent) shift, however, the social costs of production distortion resulting from a higher domestic price than the import price will be greater than under a parallel shift assumption, if the import price is the benchmark. In such circumstances, therefore, the net social benefit from research in the presence of domestic price distortions will be smaller than under a parallel shift assumption. More importantly, the alleged symmetry between Remenyi's measures of 'net social benefits' (areas $P_w f_{e_i} + f_{d_e}$ and $P_d g_{h_j} + abv$), identified on the basis of the two benchmarks (P_w and P_d), breaks down when a non-parallel shift is assumed.

Remenyi (1986) suggested another interesting aspect which needs explicit consideration in the evaluations of research gains where application of research leads to import replacement. In a situation where domestic price is maintained above the import price and when all imports are made by the private sector, research leads to a reduction of net revenues of private importers and hence it is possible that private importers may lobby against public investment in research in order to keep their net revenues intact, thus resulting in a lower level of investment in research than in the absence of such lobbying activities. If this is so, real resources will

be spent in a socially wasteful manner in lobbying activities, up to the point where the marginal cost of the resources spent to acquire the net revenue, area m_{tra} in Figure 6, equals the importers' marginal rent. Such 'rent-seeking' introduces deadweight losses (social costs) in addition to those generated by domestic price distortions, all of which reduce the magnitude of benefits from research, when the import price is used as the benchmark for the evaluation of gains from research.

Process and Product Change and Project Evaluation

The proposition that new technology must be cost reducing appears to be neither sustainable nor necessary. Much of economic development consists of a change in the product-mix which *may* be cost decreasing. It may also be cost increasing. Cost increasing technology is necessarily accompanied by an improvement in product quality or variety, or a favourable demand shift from other sources. These propositions are important considerations in the establishment of specific objectives for the ACIAR project to 'improve dried fish technology in Muncar'.

This section is drawn from a very early stage ex ante analysis of producer and consumer surpluses, net social benefits, arising from a *proposed* change in product quality of dried fish produced in Muncar, Indonesia. Much of the information about the market and assignments of values to market parameters is imperfect and rests on restricted econometric estimates for which the quality of the data base ranged from very high to less than ideal. The analysis is partial, comparatively static, and is based on broad, quite restrictive, assumptions. When the process, costs, and product characteristics which are to be altered are yet to be defined this uncertainty is to be expected. It should be remembered that the goals which appear at the outset of a project to be clear and unequivocal are the product of ignorance.

While the project envisages alteration to inputs for processing, distribution, and presentation of dried fish it is somewhat equivocal about the precise cost/product-quality configuration which will be an outcome of the project, or indeed, whether or not there is a single desired product outcome in terms of imparted characteristics. Neither is the market level at which changes may be made to the product unequivocally determined. Instead we have opted for a flexible approach which allows for reaction to observed unexploited market opportunities in the traditional system, ranging from the initial condition and grade of inputs, to their pre-processing, handling, processing techniques,

packaging, storage, transport, and presentation to the consumer.

For effective marketing strategies there are a number of feasible options. One can argue that the prices paid elasticities (n_p) give an indication of the revenue which can be generated by an improvement in quality. Indeed, this is the proposition espoused here. There is additional utility in this choice of indicator since one would expect *ex post* that positive changes in the prices paid elasticities in target markets after the introduction of product change reflect successful product variation. Alternatively, unfavourable evolution of the elasticities predicted by the value of n'_p , the rate of change in income elasticities, from prior analysis might be expected to be frustrated, reduced, or altered in sign as a consequence of successful product innovation. The propositions predicted by theory are thus empirically testable.

While only aggregate analysis for the Muncar dried fish market is attempted here, in line with the propositions relating to market segmentation espoused in Quilkey (1986), attention is drawn to the importance of the market segments to which the product is directed, and the changes in elasticities or slopes of demand functions on which market gains might be predicted (see Gunawardana and Quilkey 1986). Additionally, account must be taken of the way in which stochastic changes in demand or supply may modify the expected outcomes of particular market strategies.

In the event that improved design of fish dryers and/or techniques reduce the costs per unit of output, this can result from changes in the scale of output such that the optimum level of plant size is larger than previously. Alternatively, reduced costs can emerge from a reduction in the level of one or more inputs with the remainder unchanged or increasing some inputs and reducing others. Whatever the approach, the result is a net fall in the expenditure on all inputs. Identification of which costs are most significant in average total costs is an important feature of the research task, both in terms of particular processes in the marketing chain and in the composition of the functions carried out at each market level.

The Model

The model of product improvement in the dried-fish industry in Muncar is a simple, closed economic model. It is assumed that Muncar faces a set of demand functions for its fresh and processed products and that the product improvement process is confined to Muncar. Additionally, it is assumed that margins necessary to produce dried fish from fresh fish are known, and are of a constant unit type

and that increases in these margins take the same form.

According to the simplified model of the Muncar fish market presented in Figure 7, there are only two sectors in the market. The first of these is the total market (T). The demand for fish in this market is for all end uses and is made up of the demands of these sectors. The market for dried fish, market D, takes fish from the total market discounted for quality. The supply of fish to the dried fish market is the discounted reservation fish demand for end-uses other than dried. This demand function is assumed to have the same slope as the total demand function for fish and to face a discounted price, P_T . Under traditional processing methods for dried fish it is assumed that customary processing margins are of an absolute kind of size P_{TM} . When the processors switch to a technology which produces an improved product an additional margin MM' applies.

Demand conditions in the dried fish market in Muncar are described initially by the demand curve D'_F . When the improved product is marketed, a new demand function D''_F applies. Supplies to the traditional and new markets are the discounted reservation demand curves from the total market allowing for transformation costs, assumed to be constant additions to acquisition costs.

Under these conditions the quantities sold as dried fish are OQ'_D at a price of OP'_D under the traditional system and OQ''_D at a price of OP''_D when the improved product is sold, while OQ'_T and OQ''_T are sold for other end uses before and after the change. Hence, the surplus accruing to producers of dried fish under the traditional system is MSP'_D and under the new system $M'VP''_D$.

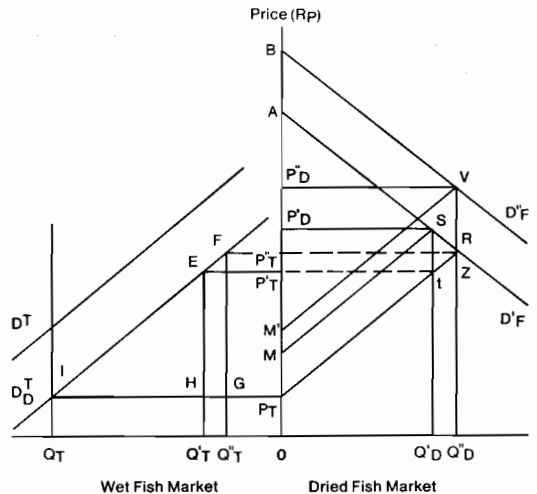

Fig. 7. Model of the effects of a change in the quality of dried fish in Muncar, Indonesia.

Consumers of dried fish receive surpluses of $AP'D_S$ under the traditional system and $BP''_D V$ with the new product.

Consumers' surpluses forgone in the wet fish market because of the transfer of quantities $OT-QT'$ and $QT-QT''$ to the dried fish processing sector are IEH and IFG , under the 'old' and 'new' systems of processing. These losses are offset by the gains in primary suppliers' surpluses in the dried fish processing sector which are indicated by areas $P_T t P_T'$ and $P_T Z P_T''$. Thus, the joint consumers' and producers' surpluses (total social benefit) in the dried fish market under old and new processing systems are MSA and $M'VB$, respectively. It is apparent from the above discussion that both consumers and producers, and hence society as a whole, gain by the improved fish drying technology, 'without harming' the consumers of lower quality wet fish.

Empirical Estimates and Discussion

Depending on the details of the model in Figure 7, some empirical estimates of the gains in consumers' and producers' surpluses and social benefits resulting from the improvements in the dried fish producing sector are presented below. Estimation procedures are discussed adequately in Edwards and Freebairn (1981) and Freebairn et al. (1982). The procedures used in this study are excluded for brevity, but are available from the authors on request.

The estimates of the gains from quality improvement in the dried fish sector are made for two specifications of the primary supply curve in the dried fish sector.

Under *Specification (1)*, the primary supply to the dried fish sector is derived from the quality discounted reservation demand in the wet fish sector.

Under *Specification (2)*, the supply curve is directly derived from the quantity of dried fish exchanged in the dried fish market. Thus, in this specification, the total demand for wet fish as a whole is omitted.

The estimates of the gains to consumers and producers and social benefits are made for a range of supply elasticities under both the specifications of the supply curve in the dried fish sector. The estimates are displayed in Table 1.

The data and parameters used in the empirical estimation are given below. These are for the year 1985.

Quantities:

Total wet fish = $QT = 5\,056\,204$ kg

Dried fish = $QDF = 1\,286\,304$ kg

Prices:

Wet fish to non-dried purposes

= $PWF = 414.25$ Rp*/kg

Quality discounted wet fish

$PWF_D = 150$ Rp/kg

Dried fish

$PDF = 330$ Rp/kg

Parameters:

Total wet fish demand = $n = -4.0$

Dried fish demand = $n^1 = -0.35$

Quantity elasticity in income = $n \frac{Y}{Q} = 0.3$

(an arbitrary 12.5% increase induced by the quality change)

Benefits were calculated for three different levels of processing margins:

Initial margin = 180 Rp/kg

10% addition to the margin = 198 Rp/kg

20% addition to the margin = 216 Rp/kg

* Rp = Indonesian rupiah; approx. 1700 Rp = US\$1.

TABLE 1. Gains (million Rp^a) in consumers' and producers' surplus and social surplus following improvements in dried fish technology and product quality.

Model Specification	Processing margins (Rp/kg)														
	180					198					216				
	2.0	3.0	4.0	5.0	6.0	2.0	3.0	4.0	5.0	6.0	2.0	3.0	4.0	5.0	6.0
<i>Specification (1)</i>															
Consumers	6.41	6.78	6.91	6.98	7.08	6.28	6.66	6.78	6.86	6.91	6.17	6.52	6.64	6.73	6.78
Producers	0.36	0.25	0.19	0.16	0.14	0.35	0.24	0.19	0.15	0.13	0.34	0.23	0.19	0.14	0.12
Society	6.77	7.03	7.10	7.14	7.17	6.63	6.90	6.97	7.01	7.04	6.51	6.75	6.83	6.87	6.90
<i>Specification (2)</i>															
Consumers	6.26	6.57	6.75	6.85	6.93	6.15	6.45	6.63	6.73	6.80	6.03	6.34	6.50	6.59	6.66
Producers	0.50	0.35	0.28	0.22	0.19	0.49	0.34	0.26	0.21	0.18	0.48	0.33	0.25	0.20	0.17
Society	6.76	6.92	7.03	7.07	7.12	6.64	6.79	6.89	6.94	6.98	6.51	6.67	6.75	6.79	6.83

^aRp = Indonesian Rupiah; approx. 1700 Rp = US\$1.

^bA demand elasticity of -0.35 is assumed.

The restrictions imposed on the analysis are such as to make the surpluses accruing to producers and consumers (purchasers) of dried fish at Muncar relatively insensitive to small changes in margins. Assumptions of relatively elastic supply and inelastic demand restrict the scope of the technical change and the associated demand shift which is conservatively set to attract large producer and consumer surpluses. We are concerned here with baseline methods rather than the empirical outcome and have detected significant weaknesses in the approach which are suggestive of modifications required for greater rigour, realism, and precision.

Improved estimates are required for all the elasticities and an improved database is necessary for the various segments of the processed fish market. It should be apparent that the main outcome of this study is to draw attention to the requirements for improved methodology and the pressure for precise data and robust parameter estimates for demand and supply functions at each market level.

At the very least, improved estimates at each market level are required for price elasticities of demand and supply, sizes of each marketing margin, and expected changes in their size, input conversion rates, elasticities of price transmission, income elasticities of demand with respect to expenditure, prices paid, and quantities, and cross price elasticities for inputs and outputs.

The estimates presented here are by any standards speculative. They are made now only to provide an early guide to the methodological, data, and assessment needs of the study. It is only at this stage of the project that we have *prospects* of meeting the quite demanding requirements for the assessment of technical, product, and transformation changes.

It may be appropriate as a next step to restrict the estimates to gains in producer surplus from a successful quality change. The expectation we would hold is that where a quality change occurs in dried fish this would be evidenced by a change in the prices paid elasticity. Given that the price elasticity of demand, the price elasticity of supply, the cost of the change (C), and the level of sales (R) are known we can ascertain the elasticity of prices paid (n_p) necessary to achieve different levels of producer surplus. Alternatively, given some estimate of the income elasticity (n_p) we can determine the optimum level of quality change.

There are a large number of modifications to be made to the primitive model used here. These modifications include further development of the concepts surveyed in a number of studies, such as Lindner and Jarrett (1978), Edwards (1984), Gunawardana and Quilkey (1986), and Houck (1967), and improved estimates of market

parameters, conversion rates from wet to dry fish, costs of drying and marketing margins from wet fish to the consumer. All these are targets of existing or projected studies.

Concluding Remarks

Changes in technology and other market parameters may influence the shape and position of both the supply and the demand curves for particular products and factors of production. The approach which is usually adopted in ex post economic appraisal of such changes is to simplify the outcomes in terms of assuming parallel shifts in linear demand and supply functions or to assume constant elasticities and to identify the divergent or convergent shifts in the two functions which occur as identified by observed price-quantity coordinates for the two functions.

These approaches are highly mechanistic and allow the restrictions imposed to determine the outcomes in terms of changes in producer, consumer, and social surpluses. Economic theories about the impacts of the projected or actual changes are allowed a very restricted role in identifying influences on the extent and incidence of demand and supply shifts and on the nature and order of changes in the price elasticities of demand and supply which may result from factors such as alterations in substitution possibilities in the factor and product markets due to the changes in technology and other market parameters.

A consistent methodology would seem to be one in which economic theory largely dictates the nature and order of change to be expected in the market parameters. Economic logic should, according to this view, dominate the particular form which market outcomes will take. It should thus be possible to determine ex post by empirical methods whether or not the expectations which have been formed on the basis of economic theory have been realised.

It is common practice to employ linear supply and demand functions in appraisal of new technology and it is here that an approach employed by Duloy (1967) may be of use in segregating subsets of demand or supply functions with which we can refine the allocation of producer and consumer surpluses arising from technical change. With appropriate caveats the function can be estimated simply from time series or cross-sections and the sub-demands derived.

A similar approach might be adopted for large or small producers in the estimation of supply curves and more than a two-way classification system can be accommodated. Such an approach is to be

adopted in deriving supply functions for dried fish in Indonesia.

In the long haul we need to do some detailed work on combined time series and cross-sections to get parameter estimates that reflect demographic, sociocultural, and regional influences on market behaviour. No amount of econometric clucking over warmed-up time series will produce estimates that are sufficiently disaggregated to tell us anything about real markets and market responses to new technology and product variation.

For a quick and dirty look we can do the sort of thing we suggest here and employ a mixture of sophistry, intuition, and quasi-wisdom to guess at the effect of technical change on processes, on products, on costs, and consumer expenditure.

Alternatively, we may recognise that there is no 'quick fix' and spend some resources on data of a quality that matches the sophistication of the available econometrics.

In the end it may be that Rose (1980) is quite correct in suggesting that 'the best information available may be a cost reduction estimate for a single point on the supply curve'. The engineering estimates of benefits are then very nearly the same as the assumption of a parallel shift with only a minor adjustment to account for price response. We are conscious of Rose's warning that there has been undue concentration 'on increasing the geometric sophistication of explanatory models' and that what is required is 'an understanding of supply curves and the derivation of cost curves' (Rose 1980: 837).

References

Aliston, J.M., and Scobie, G.M. 1986. Distribution of research gains in multistage production systems:

comment. *American Journal of Agricultural Economics*, 65, 353-356.

Duloy, J.H. 1967. Structural changes due to immigration: an econometric study. *Australian Economic Papers*, vol. 6, no. 9.

Edwards, G.W. 1984. The allocation of resources to shifting supply and demand for traded commodities. Presented at 13th Conference of Economists. Perth, Western Australian Institute of Technology.

Edwards, G.W., and Freebairn, J.W. 1981. Measuring a country's gains from research: theory and application to rural research in Australia. Report to the Commonwealth Council for Rural Research and Extension. Canberra, Australian Government Publishing Service.

Freebairn, J.W., Davies, J.S., and Edwards, G.W. 1982. Distribution of research gains in multistage production systems. *American Journal of Agricultural Economics*, 64, 39-45.

Gunawardana, P.J., and Quilkey, J.J. 1986. Shifts in short-run demand and supply curves and their implications for ex-post evaluation of agricultural pricing policies. Presented at 30th Annual Conference of the Australian Agricultural Economics Society. February 1986, Canberra.

Houck, J.P. 1967. Price elasticity and linear supply curves. *American Economic Review*, 57, 905-908.

Lindner, R.K., and Jarrett, F.G. 1978. Supply shifts and the size of research benefits. *American Journal of Agricultural Economics*, 60, 48-58.

Quilkey, J.J. 1970. The merino export embargo — a comparative static analysis. *Australian Journal of Agricultural Economics*, 14(2), 63-71.

1986. Primary product promotion: a view from the cloister. *Australian Journal of Agricultural Economics*, In press.

Remenyi, J.V. 1986. Issues in smallholder tropical dairying. *Bulletin of Indonesian Economic Studies*, 22, 57-87.

Rose, R.N. 1980. Supply shifts and research benefits: comment. *American Journal of Agricultural Economics*, 62, 834-837.

Marketing Margins and Grain Quality: Factors for Institutional Change

B. Duff *

Abstract

Rapid increases in rice output over the past three decades have increased the marketable surplus at nearly twice the rate of production. Combined with rapid rates of urbanisation, increased income, and greater government intervention, there has been a substantial increase in the demand for marketing services. Examination of historical marketing margins fails to demonstrate inefficiencies resulting from lack of market competition. Emerging surpluses and declining real rice prices have induced a strong consumer preference for improved grain quality. Both technical and varietal improvements must be mobilised to tailor quality to meet diverse local preferences. Simple models with minimal data requirements are outlined which permit assessment of marketing margins and consumer preferences.

RAPID growth in rice production coupled with a high degree of urbanisation since 1960 has induced major adjustments throughout rice marketing systems in Asia. Engineers have generally led the search for solutions to adjustment problems. The result has been a range of projects and programs to update and modernise, with emphasis on the technical features of the marketing system. More recently, research has been initiated to examine marketing institutions and factors which impact on market performance. This paper briefly examines the organisation of rice markets, and changes in production and demographic factors which have induced growth and institutional adjustments in marketing systems, and suggests two areas — marketing margins and grain quality — that would benefit from additional research.

Organisation of Rice Markets

During the past 20 years, the volume of rice required by *urban* consumers has grown at rates 50 to 100% higher than demand in rural areas. It has been estimated that by 1980 more than 50% of the rice crop was moving into commercial marketing channels (Barker and Herdt 1985). Many

components of traditional marketing systems, such as hand pounding and trading in stalk paddy, have rapidly declined or disappeared (IRRI 1978; Ingram 1971).

Governments have assumed an active and sometimes dominant role in the procurement and marketing of rice. Government intervention is most often justified by the belief that it is necessary to place controls on the marketing system to ensure that urban consumers are able to buy rice at acceptable prices and that producers receive a fair price for their product. Food security and self-sufficiency are often voiced as additional reasons for government participation. Much of the economic evidence accumulated during the past decade does not support government intervention on efficiency grounds (Timmer 1974; Siamwalla 1975; Barker and Herdt 1985; Mears 1982). Private handling of rice marketing functions appears to have been at least as efficient as government agencies, given the limitations of the available marketing infrastructure. While there are undoubtedly improvements that can be made to increase the technical efficiency of operations such as processing, storage, and drying, these innovations will almost certainly increase marketing costs.

The marketing system is made up of exporters, retailers, wholesalers, processors, traders, input suppliers, financial intermediaries, farmers, and

* Agricultural Economist, Department of Agricultural Economics, International Rice Research Institute (IRRI), P.O. Box 933, Manila, Philippines.

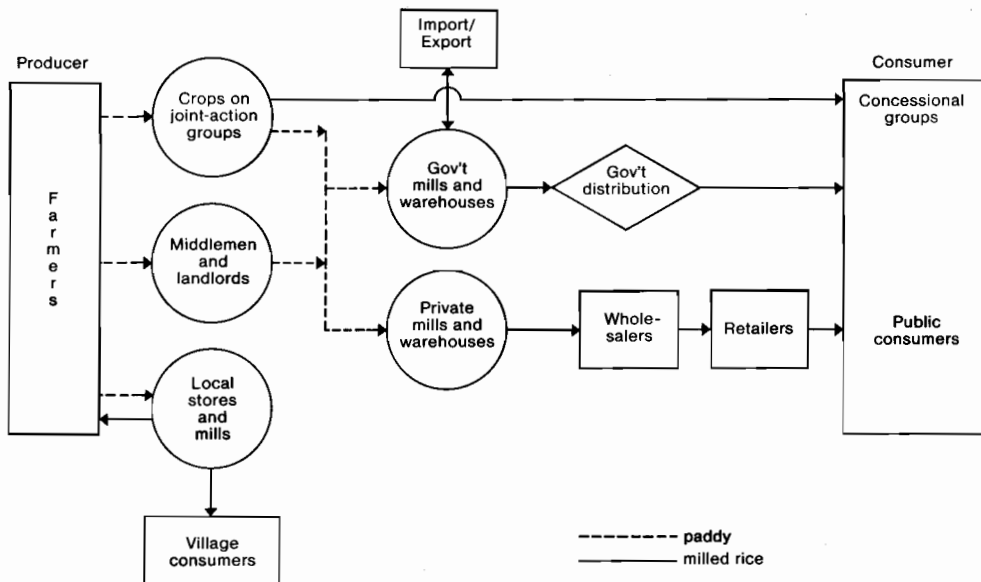

Fig. 1. Flow diagram of traditional rice marketing system. Adapted from Barker and Herdt (1985:173).

government agencies. Figure 1 illustrates paddy and milled rice flows and the relationships between functionaries in the system. While the figure is an oversimplification, it captures the major interactions as paddy and milled rice move from farm to the consumer. To generalise further, there are several common elements which characterise all Asian rice markets. The market is composed of many small producers, a large number of consumers who frequently purchase small quantities, and a small number of middlemen who ensure the proper form (processing), location (transportation), and time (storage) functions are added to the product. In addition, there exist three well-defined marketing channels: (1) small local or rural markets; (2) urban commercial markets that are usually private; and (3) government activities which include concessional sales, exports and imports, and procurement/sales to support market regulatory activities.

Marketable Surplus

Economic research has found that the marketable portion of total production has an elasticity greater than one. Stated differently, as production increases, farmers market an increasing proportion of the crop. Conversely, as rice output increases, the proportion retained for home consumption declines. This relationship is illustrated in Figure 2 using data from the Philippines.

The methodology and data requirements for analysis of the marketable surplus are found in Toquero et al. (1975). A key reason for studying the marketable surplus issue has been to measure the

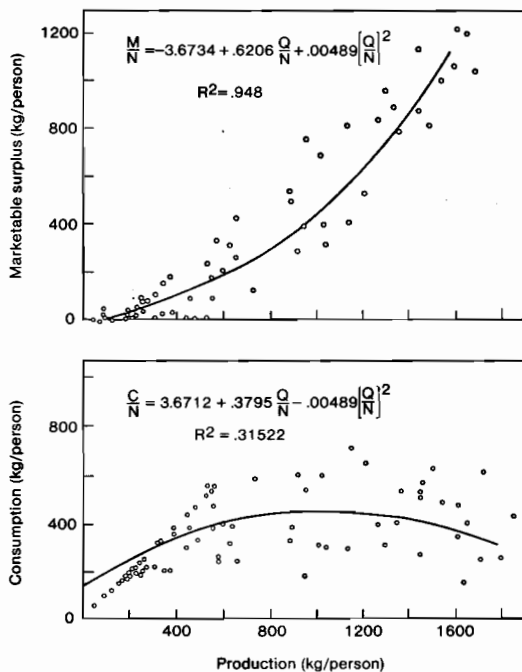

Fig. 2. Relationships between household consumption, marketable surplus, and production for Philippine rice farms (Toquero et al. 1975).

impact of price policy on the quantity (and quality) of rice entering the market and to determine which farmers are likely to contribute what portion of this incremental change. Figure 3 illustrates the differential level of the marketable surplus across four communities in the Bicol region of the Philippines. Examination of Table 1 shows that farm size has an inverse relation with marketable surplus. Research on the marketable surplus function also allows examination of the equity impact of pricing policy and the likely impact of new technology, by analysing changes in the marketable surplus by farm size, region, by specific rice-growing ecologies, and by income class. For policy makers, such research allows assessment of

the relative costs of price supports versus investments in research.

The above discussion highlights the earlier statement that marketed surplus has increased significantly faster than production in most of Asia. Conversely, in areas where production has stagnated (such as much of Africa), the portion entering the market has probably declined.

The major conclusion of marketable surplus research in relation to postharvest activities is that the volume of unmilled and milled rice moving into commercial channels has increased by more than 4% per year over the past 20 years (Baker and Herdt 1985). The implications are for continual

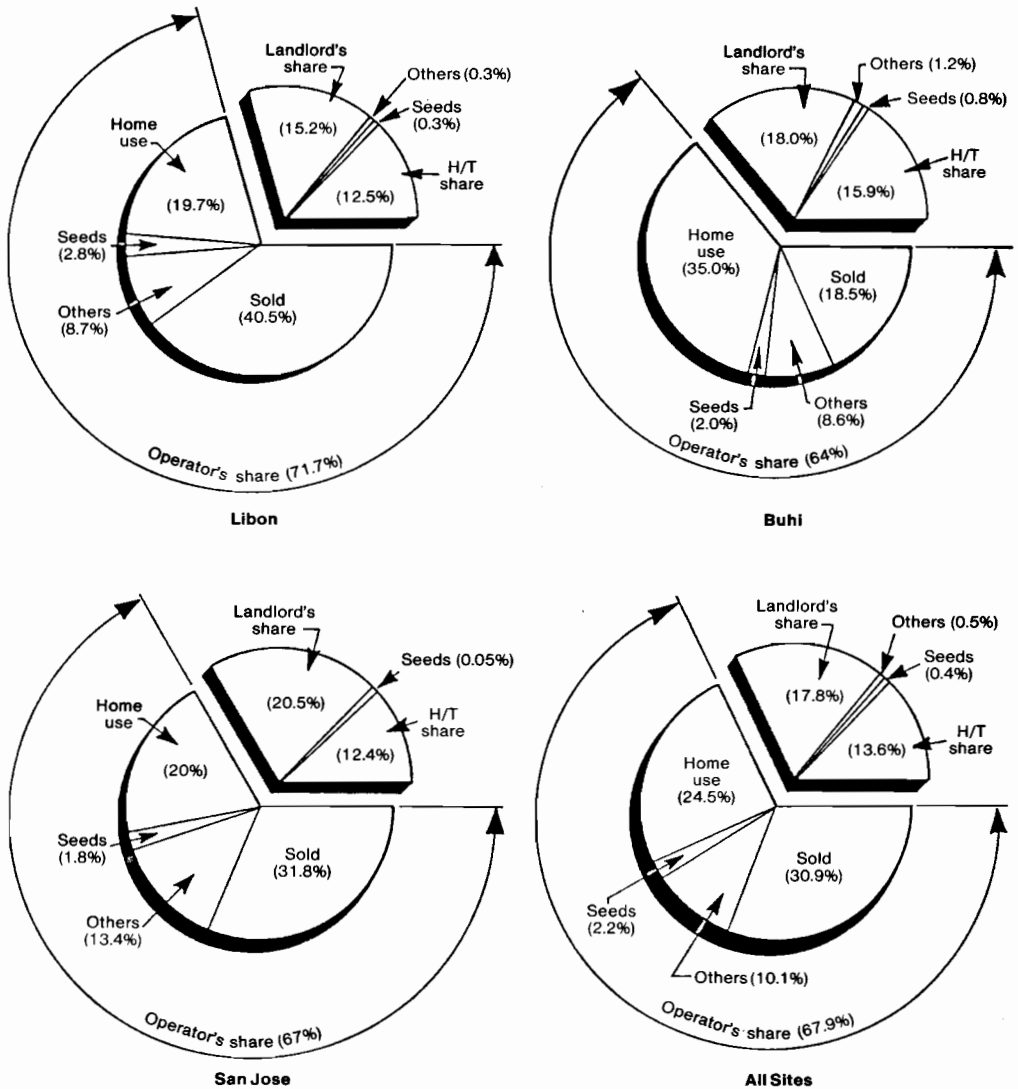

Fig. 3. Production and disposal of paddy by 137 farmers in three villages of the Bicol Region, Philippines, 1978.

institutional adjustment and technical innovation in each of the three subsectors making up national rice marketing systems in Asia. The demand for marketing services such as packaging, grading, and improved quality will increase, particularly with rising incomes, low or declining real rice prices, and increased farm level production.

Marketing Margins

Numerous studies have evaluated rice marketing margins (Timmer 1974; Unnevehr et al. 1984; Pinthong 1977; Yeh 1955; Mears 1959). A general practice has been to compare price differences with actual costs by examining farm-to-retail margins or selected functions such as transportation, storage, or milling to assess the existence of excess profits. Excess profits are the usual measure of competitiveness in the market. Figure 4 (Timmer 1974) represents a simplified view of the commercial rice marketing system from farm to retail, ignoring the local and government channels shown in Figure 1. The vertical dimensions of Figure 4 depict value changes in space and form. The horizontal axis describes value changes over time. Transport and processing costs fall on the vertical axis and are usually expressed as absolute charges (cost/kg). Storage costs are associated with the horizontal axis as they are proportional to the time the commodity is held in storage. Trading fees and the profit of market intermediaries are proportional to the value of the rice. The marketing margin is normally expressed as a ratio of the difference between the retail and farm price divided by the retail price. There is no reason to believe that this proportion will remain constant as rice prices fluctuate over time. The bulk of marketing costs consist of transportation and milling charges which are assessed on a per-kilogram basis.

Table 2 summarises the findings from selected studies of rice marketing margins in South and Southeast Asia. For each site shown, an attempt was made to bring together two or more marketing margins. These were estimated for different years and by different researchers. The producers' share of the retail price ranges from 58 to 83%. Except in Taiwan, where the retail trader's margin seems to have risen sharply, marketing margins in more recent years have tended to decline. The margin between farm and retail is low compared with developed countries such as the United States, Italy, and Australia where farmers received less than 40% of the retail price. High margins in the developed countries reflect the demand for additional transport, packaging, and marketing services. The data in Table 2 say little, however, about marketing efficiency either within or among countries. In Indonesia, margins vary appreciably during the year, reflecting the fact that rice flows from rural to urban areas in periods of relatively abundant domestic supply, but may be reversed during the

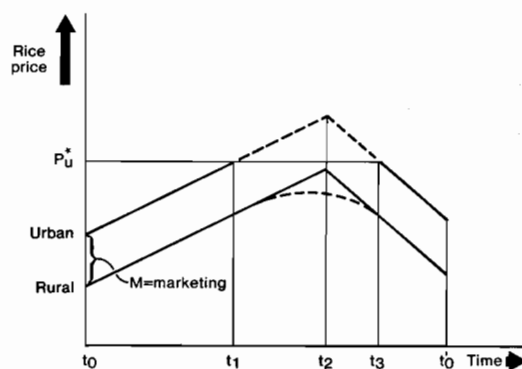

Fig. 4. Model of urban-rural margin behaviour over time (Timmer 1974).

TABLE 1. Production and disposal of paddy by 137 rice farmers in the Bicol Region, Philippines, 1978.

	Libon	Buhi	San Jose	All
Rice area per farm (ha)	3.97	1.58	3.73	2.71
Production per farm (t)	11.1	5.1	13.7	8.6
	Per cent values			
H/T share ^a	12.5	16.0	12.4	13.5
Seeds	0.3	0.8	0.1	0.4
Others	0.3	1.2	-	0.5
Landlord's share	15.2	18.0	20.5	17.8
Operator's share	71.7	64.0	67.0	67.8
Home consumption	19.7	35.0	20.0	24.5
Seeds	2.8	2.0	1.8	2.2
Others	8.7	8.5	13.4	10.1
Quantity sold	40.5	18.5	31.8	31.0
Marketable surplus	49.2	27.0	45.2	41.1

^aHarvester/thresher share.
Source: IRRI (1978).

lean months of heavy importation (a condition which has changed markedly during the past three years). During lean months, rural prices may at times exceed urban prices (see Fig. 5).

Thai farm prices are closely linked to Bangkok wholesale prices, which in turn are affected by export demand. Thus, in Thailand, price forces flow from urban to rural areas rather than rural to urban as in the case of most rice exporters. In both the Philippines and Thailand, marketing margins are appreciably higher at harvest than other times of the year because of the shortage of milling capacity and the inability of producers to finance their own

storage operations. Marketing margins varied by about 30% from peak seasons through the lean season in both countries (Unnevehr et al. 1984). Increased farm storage and finance could raise farm prices, narrowing the harvest margin.

Analysis of price differences between regions is normally based on the price spread between markets being compared with the cost of handling and transport. A price spread between markets approximating transportation costs suggests a competitive market.

Transportation systems in Asia have undergone a complete change in the past three decades. Ingram (1971) noted:

... prior to 1950, no natural road systems existed in Thailand. Such roads as did exist were feeder roads for the railroad, unpaved provincial roads largely used by bullock carts, and short stretches of road around Bangkok. Interregional transport of goods and people scarcely existed. Such transport took place by rail and water and was therefore limited to the area served by this means.

With the development of road networks throughout Asia, there was a substantial change from rail and water to truck haulage. For hauls exceeding 100–200 km, trucks are more expensive than either railway or water or both. However, the greater flexibility of trucks favours their use even at rates more expensive than alternative modes of transport.

Mears et al. (1974) and Pinthong (1977) found that the cost of transportation rapidly exceeded the cost of milling when haulage exceeded 200 km.

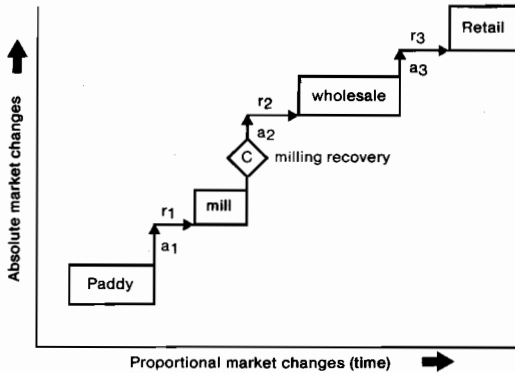

Fig. 5. Rice marketing system embodying changes resulting from changes in ownership and time (proportional) and in form and space (absolute) (Timmer 1974).

TABLE 2. Marketing margins for rice in Asia, 1953–74.

Location	Year	Site		Distance	Producers' shares (%)	Portion of total cost			Marketing margin (%)	References
		Production	Market			Processing, storage, and transportation costs (%)	Transportation costs only (%)	Traders margin (%)		
Taiwan	1953	Pingtung	Taipei	400	67.9	30.6	3.6	1.5	32.1	Yeh (1955)
Taiwan	1974	Pingtung	Taipei	400	58.3	26.6	3.2	15.1	41.7	APO (1976)
Indonesia	1955	Krawang	Jakarta	100	60.0	-	-	-	40.0	Mears (1959)
Indonesia	1955	Krawang (Channel I)	Jakarta	100	79.8	11.5	-	8.7	20.2	Adiratma (1969)
		Krawang (Channel II)	Jakarta	100	72.5	20.2	-	7.3	27.5	
Indonesia	1978	Krawang	Jakarta	100	83.9	-	7.8	-	16.1	Mears (1982)
India	pre WWII	W. Godavari	Madras	500	63.2	25.2	9.6	11.6	36.8	India, Directorate of Marketing and Inspection (1954)
India	1970	W. Godavari	Madras	500	82.9	13.8	8.7	3.3	17.1	George and Choukidar (1972)
Philippines	1966	Central Luzon	Manila	100	80.3	12.9	3.3	6.8	19.7	Mears et al. (1974)
Philippines	1970	Central Luzon	Manila	100	78.5	12.6	4.4	8.9	21.5	Mears et al. (1974)

Source: Barker and Herdt (1985).

Transport costs range from 3 to 10% of total marketing cost for selected areas (Table 2).

Studies in the Philippines and Indonesia imply a much lower degree of market integration than found in Thailand, Burma, or other land-bound nations. In Mindanao, marketing margins are twice the level of Central Luzon because of poor transportation and the existence of a few large rice mills. For similar reasons, marketing margins on the outer islands of Indonesia are also higher than on Java.

For storage, there are issues related to both technical efficiency and the loss of rice and to economic efficiency and the cost of storage. Rice is stored as paddy or in milled form both in bulk or in sacks. Estimates of losses in storage range from less than 1% to as high as 10% (Toquero and Duff 1985). There is general agreement in studies investigating the profitability of storage that storing rice is extremely risky. The financial riskiness of storage may be the main reason cultivators market heavily following harvest. By selling at harvest, the farmer transfers his risk to the trader or processor. The volume of rice handled by traders and the profit they earn vary widely from year to year. Because of different strategies, all traders do not earn a high rate of profit in one year and a low rate in another. There is no basis to accurately predict whether profit or loss will result from holding rice stocks during any specific year. The high loss probabilities found in research studies present a striking contrast to the high profit margins cited in street rhetoric.

In summary, further investigation of marketing margins that tightly focused on discrete marketing functions and encompassed a range of location and submarkets would permit clearer assessment of the competitiveness of the rice marketing system. The methodology suggested by Timmer (1974), which employs readily available price data, should be extended and refined to develop a clearer picture of the structure and efficiency of rice markets.

Grain Quality and Consumer Preferences

Surpluses in world marketable supplies have regenerated interest in improving the quality of modern rice varieties. Until very recently, the paramount goal of plant breeders had been to increase and stabilise yield potential and to extend the benefits of increased yields to disadvantaged areas. Since 1975, the real price of rice has declined substantially in world markets and within countries in Asia. The result has been increased demand for improved cooking and eating quality.

While there is undoubtedly scope to improve grain quality through technical modernisation of rice postharvest systems, a key criterion of consumer preference will remain the variety itself. For this

reason the International Rice Research Institute (IRRI) and national breeding programs throughout Asia have renewed attempts to incorporate quality characteristics in the selection of new and promising varieties.

As a first step to assess consumer preferences, market price data can be used to provide information about the average preferences of consumers who make their purchases in the retail market. Estimates of the implicit values of quality test how consumer preferences correspond to the measures of quality used to screen materials in rice breeding programs. In addition, these implicit values permit a cross-country assessment of preferences for grain quality and allow judgments of whether or not grain quality should be undertaken through national or international research programs. The methodology developed by Ladd and Suvannunt (1976) was modified by Unnevehr et al. (1985) to test consumer preferences through the retail rice price mechanism. The model assumes consumer demand is based on product utility which is a function of the grain's chemical and physical characteristics. The components of the model are as follows:

$$P_R = \sum_{i=j}^m X_{Rj} P_{Rj}$$

where:

P_R = market price of rice

X_{Rj} = the amount of characteristic j in one unit of rice, and

P_{Rj} = implicit value of characteristic j

The full model is expressed with a random disturbance term u which allows use of ordinary least squares regression to estimate the parameters of the equation. The dependent variable, P_{Rj} , will vary for different grades of rice. The independent variables, the X_{Rj} 's, explain the variance in the rice price. The parameter estimates, P_{Rj} 's, give the implicit values for grain characteristics.

Physical characteristics included in the analysis were grain whiteness, broken grains, grain shape, and chalkiness. The degree of whiteness and quantity of brokens indicate milling quality. Shape, the ratio of grain length to weight, and the degree of chalkiness in the grain are varietal characteristics. Consumers generally prefer white, long grain rice with few brokens and little chalkiness. Chemical characteristics include amylose content, gelatinisation, temperature, gel consistency, and aroma. Amylose content is the most important chemical characteristic and determines the hardness of cooked rice. The percent amylose content can be evaluated through a simple laboratory procedure. Prototype sampling of retail markets in Indonesia,

Thailand, and the Philippines produced the results presented in Table 3.

Thailand is the world's largest rice exporter. Clearly world market preferences for long grain rice with good milling quality greatly influence domestic market preferences. While Thai scientists have used IRRI varieties as parents in crosses to develop new semi-dwarf varieties with the physical grain quality demanded by the world market, they have not, however, released IRRI varieties directly because of their lower quality characteristics. The sample collected in Thai retail markets had a low percentage of brokens and longer grains than samples from Indonesia and the Philippines. The Thai samples were all traditional varieties having intermediate amylose content. In addition, many of the Thai samples were aromatic.

The implicit prices shown in Table 3 represent the change in the rice price for a one-unit change in the characteristic. The quality attributes included in the regression explain a large proportion of price variation in all three countries, indicating that the simple laboratory measures generate good indicators of consumer preference.

For the Philippines, all grain quality characteristics except gel consistency and shape are significant. Philippine data did not include aromatic samples. Consumers show the expected preferences for physical quality and amylose content, but the implicit value of gel temperature has an unexpected sign, probably because of the low gel temperature exhibited by the upland rices and fine grain IR-42 included in the samples.

Indonesian consumers also prefer significantly better milling quality and a white rice. Because Indonesian consumers prefer local traditional varieties with short, chalky grains, there is a negative implicit price for shape and no significant response for chalkiness. As in the Philippines, the positive implicit price for gel temperature indicates an expected preference for low gel temperature, probably because of the low gel temperature of the traditional varieties.

The prototype methodology outlined by the Unnevehr study clearly has potential for examination of consumer preference patterns using simple criteria. These preferences can be translated both through breeding programs and by innovations in the marketing system into improved grain quality through provision of a combination of improved varieties and technology. Only some of the characteristics measured in the prototype study can be substantially improved through plant breeding. In addition to inherited traits, grain quality is determined by the cultivation environment and postharvest handling. While breeders can manipulate potential head rice recovery, chalkiness,

shape, and chemical variables, they cannot affect the impact of improper handling that produces yellowing, fissuring, and other effects which are not inherent in the grain itself. Clearly, the extent of improvements in handling and postharvest processing will depend on the consumers' willingness to pay for better quality and the cost of technology.

There are a few consumer preference studies for rice available. Planning and implementation of research on preference mapping may permit very localised analysis of quality characteristics which can be translated into improved grain quality through a combination of genetic and engineering development.

Implications for Research

The gradual transformation of demand patterns from rural, predominantly subsistence, to urban, highly centralised markets will continue to increase the quantity of paddy and milled rice entering commercial marketing channels. At the initial stages, increased demand for marketing services will be met from under-utilised capacity. In the intermediate and long run, it will be necessary to increase overall capacity and eventually expand the range of marketing services.

These structural changes give rise to the need for research on the following:

1. disaggregation of elements making up structural transformation with a clear specification of the effects of urbanisation, population growth, and changes in income on the marketable surplus;
2. research to pinpoint sources of real and economic losses in postharvest systems using the marketing margins;
3. mapping of consumer preferences for grain quality characteristics;
4. broadening the mix of disciplinary resources brought to bear in seeking solutions to problems affecting the post-production systems.

The downward trend in real rice prices induced by an abundance of supply will continue pressures for improving grain quality and marketing services. Part of the response to these needs lies in improved technology. In the short run, engineering solutions will be the primary source of improvements. To ensure equity on the distribution of benefits, however, and to meet preferences not amenable to mechanical solutions, it is important that plant breeders target changes in grain quality which are achieved at the farm level. Lastly, the economists should be involved, in order to establish the mix of incentives that will ensure that the needs of consumers are met.

References

- Adiratna, I.R. 1969. Income and expenditure pattern of rice producers in relation to production and rice marketed: a case study of Krawang, West Java. PhD dissertation. Institut Pertanian Bogor, 345 p.
- APO (Asian Productivity Organisation). 1976. Economics of food grain distribution: the Asian scene. Tokyo, APO 240 p.
- Barker, P., and Herdt, R.W. 1985. The rice economy of Asia. Washington, D.C., Resources for the Future, 324 p.
- George, P.S., and Choukidar, V.V. 1972. Production and marketing of paddy. (A study of local high-yielding varieties in the West Godavari District). Ahmedabad, Indian Institute of Management, 270 p.
- India, Directorate of Marketing and Inspection. 1954. Report on the marketing of rice in India. Calcutta, Government of India Press.
- Ingram, J.C. 1971. Economic change in Thailand, 1850-1970. Stanford, California, Stanford University Press.
- IRRI (International Rice Research Institute). 1978. The technical and economic characteristics of rice post-production systems in the Bicol River Basin. Report submitted to Bicol River Basin, Development Programme, Los Baños, IRRI, 141 p.
- Ladd, G.W., and Suvannunt, V. 1976. A model of consumer demand for goods characteristics. American Journal of Agricultural Economics, 58, 504-510.
- Mears, L. 1959. Rice marketing in the Republic of Indonesia. Jakarta, P.T. Pembangunan, 478 p.
1982. The new rice economy of Indonesia. Jakarta, Gadjah Mada University Press, 605p.
- Mears, L., Agabin, M.H., Anden, T.L., and Marquez, R.C. 1974. The rice economy of the Philippines. Quezon City, University of the Philippines Press, 455 p.
- Pinthong, C. 1977. A price analysis of the Thai rice marketing system. PhD dissertation, Stanford University, 319 p.
- Siamwalla, A. 1975. Farmers and middlemen: aspects of agricultural marketing in Thailand. Agricultural marketing case study No. 2 Bangkok, UN Asian Development Institute.
- Timmer, C.P. 1974. A model of rice marketing margins in Indonesia. Food Reserch Institute Studies, 13(2), 145-167.
- Toquero, Z.F., Duff, B., Anden-Lacsina, T., and Hayami Y. 1975. Marketable surplus functions for a subsistence crop: rice in the Philippines. American Journal of Agricultural Economics, 57, 705-709.
- Toquero, Z.T., and Duff, B. 1985. Physical losses and quality deterioration in rice post-production systems. IRRI Research Paper Series No. 107, 12 p.
- Unnevehr, L.H., Gascon, F., and Vidao, N. 1984. Farmers' rice sales and purchases in Nueva Ecija and Pangasinan. IRRI Agricultural Economics Department Paper No. 84-11.
- Unnevehr, L.J., Juliano, B.O., and Perez, C.M. 1985. Consumer demand for rice grain quality in Southeast Asia. In: Rice grain quality and marketing. Los Baños, International Rice Research Institute, 15-13.
- Unnevehr, L.J. Juliano, B.O., Perez, C.M., and Mariano, E.B. 1985. Consumer demand for rice grain quality in Southeast Asia. IRRI Research Paper Series No. 116, 20 p.
- Yeh, S.M. 1955. Rice marketing in Taiwan. Economic Digest Series No. 7. Taipei, Joint Commission on Rural Reconstruction, 98 p.

Relative Effectiveness of Private and Public Organisations in Postharvest Handling of Grain

R.R. Piggott, E.M. Fleming, and V.E. Wright *

Abstract

Arguments for departures from free-market conditions in agricultural marketing are explained. These arguments are grouped into efficiency considerations and price-policy considerations. The comparative advantages of different marketing organisations in achieving various objectives are then examined. It is argued that private agents have incentive structures most consistent with efficiency considerations. Price policy objectives are often inconsistent and pose major challenges for marketing organisations. The paper concludes with a review of research findings relating to the effectiveness of various marketing organisations in improving the welfare of smallholder grain producers.

THIS paper has five sections. The first three are general and cover issues not necessarily specific to grain handling and transportation, or to developing countries. The first of these is an overview of the reasons for departure from the *laissez-faire* (or free-market) model in agricultural marketing and the organisational forms which result. Because these reasons can be grouped into two broad categories — efficiency considerations and price policy considerations — the subsequent two sections are given over to discussing these. In the fourth section, attention is given to the evidence on the relative efficiency of various organisational forms in catering for the needs of smallholder grain producers in developing countries. Conclusions are drawn in the final section.

Reasons for Intervention, and Organisational Forms

Traditionally, farmers have been suspicious about the role played by private agents in postharvest handling of agricultural commodities, especially the returns they earn from this activity. Insofar as some of these marketing activities (e.g. transport, grading, and storage) involve little or no change in the physical form of the product, some farmers

doubt their necessity. Furthermore, even for marketing functions which are accepted by farmers as legitimate, the costs of these activities (e.g. opportunity costs of capital involved in storage) are sometimes either not apparent to them or they tend to underestimate them, perhaps understandably given the readily apparent nature of costs involved in the farming process. If one couples this lack of understanding of the need for certain marketing activities, and the costs involved, with farmers' suspicions about lack of competition and efficiency among private marketing agencies, the result is the frequent claim by farmers that marketing margins are excessive. Governments have responded by facilitating the establishment of a variety of marketing institutions. These institutions are expected to play a 'pacesetter' role with regard to efficiency (Babcock 1935) and to exert 'countervailing power' (Galbraith 1952).

Another explanation for intervention follows from the fact that *laissez-faire* agricultural markets are prone to instability, a characteristic usually attributed to volatile, highly price-inelastic demand and supply functions. Additionally, these markets can generate returns which are regarded as too low to sustain an acceptable living standard. While governments can offset these effects, at least for short periods, through direct financial assistance measures, such measures may appear more costly to governments than the alternative of providing a legislative basis for some agency which attempts to

* Department of Agricultural Economics and Business Management, University of New England, Armidale, N.S.W. 2351, Australia.

manipulate markets in such a way that they generate higher and more stable returns (Campbell 1973). Even if the latter alternative is not less costly in practice, the fact that its costs may not be so apparent in budget papers would hold some appeal for governments.

In developing countries there are additional reasons for intervention in agricultural marketing. Some agricultural economists, for example those within FAO, have stressed the role which an effective marketing system can play in enhancing development, and how different marketing institutions impact upon the welfare of small farmers (see, for example, Abbott 1985). In some cases, governments view particular agricultural commodities as being so politically important that their marketing cannot be left entirely to the private sector. Indonesian rice marketing is a case in point (Timmer 1975). The importance of rice in the income structure of Indonesian farmers, as a wage good for public servants, and as a determinant of the consumer price index, has resulted in a complex marketing system involving private traders, cooperatives, and government authorities. In many developing countries, marketing institutions are expected to play a key role in implementing food self-sufficiency policies and distributing food to the poor. In some cases they are used as fiscal agents of the government (Blandford 1979).

The foregoing discussion covers what might be called the stated rationale for departures from free agricultural marketing. Some authors are skeptical about the motives for intervention and regulation. In a classic account of the Australian situation, Sieper (1982) is unimpressed by altruistic claims by agricultural market regulators that their activities are in the 'public interest'. Rather, he views the Australian pattern of regulation in agricultural markets as the outcome of demand and supply forces: politicians have distributive powers which they are prepared to supply in response to demands from pressure groups to redistribute income in their favour, the 'price' being political support. In developing countries, distributive powers are used quite overtly in some cases (e.g. food-for-the-poor policies) and, no doubt, covertly in others (see, for example, Krueger 1974).

Governments have promoted or legislated for three general types of marketing institutions. As their names imply, two of these — voluntary farmer cooperatives and compulsory marketing boards — are at opposite ends of the spectrum in terms of their legal requirement for farmer involvement. A third type of institution can simply be termed a regulatory agency, and may be of different complexions with respect to involvement in product handling and type of market activity. For example, it might be an

agency which is involved only in monitoring product quality or it might be an agency which undertakes market operations for purposes of stabilising prices (e.g. Indonesia's BULOG). These three broad types of institution tend to coexist in any one country.

Efficiency Considerations

Economic efficiency can be difficult to judge in practice. One difficulty arises because of the pervasive nature of uncertainty and the fact that information is costly (Pasour and Bullock 1975). Firms have to make decisions in an uncertain environment and there is little point in confronting them with efficiency norms (such as outcomes under perfect competition) which assume that they have access to perfect information. Spatial equilibrium analyses of the efficiency of existing marketing infrastructures (e.g. Harriss 1978), or of planned marketing infrastructures, are vulnerable to the use of inappropriate (i.e. perfect market) norms. For example, it would be a disservice to planners to advocate a locational pattern of rice mills and storage warehouses that assumes a known pattern of throughput when, in fact, throughput patterns are prone to some randomness. In this case, the efficient system could be one which can handle departures from the mean throughput without too great an escalation in unit costs, even though it may not be the least-cost system for handling the mean throughput. Also, the least-cost alternative has to be chosen subject to the appropriate *political* constraints.

Another problem confronting comparative efficiency analysts is the fact that *certis paribus* (other things being equal) conditions rarely hold. For example, a matter of great interest to various parties is the relative efficiency of the Canadian and United States grain marketing systems. The former is highly regulated by the Canadian Wheat Board, while the latter is, more-or-less, *laissez-faire*. However, comparisons for the two systems are complicated because, unlike Canada, the United States has a price support system in place which impacts upon those dimensions of performance normally used in comparative efficiency analyses (McCalla and Schmitz 1979).

These difficulties associated with comparative efficiency analyses have resulted in economists turning to a priori consideration of the incentives to be efficient that exist in different institutions. Business management and public choice theorists have provided useful insights in this regard.

Incentive Structures and Capacity for Innovation

Within any organisation, the degree of interest in new technology depends on the pressure members

of the organisation feel to maximise efficiency. In turn, this pressure depends upon the organisation's goals. The type of organisation most *persistently* concerned with efficiency is the private business firm with its focus on profit. In contrast, government agencies and marketing boards tend to be more concerned with adherence to formal procedures — doing things according to the regulations. This led a former General Manager of the Grain Elevators Board of Victoria (Australia) to remark (Stoney 1986) that:

One of the main barriers I have encountered is the management/administration conflict. . . . The problem is that much 'management' time is being taken up in administering the legislation under which they operate rather than managing their organisations to ensure that the most efficient and cost-effective service is being provided . . . and that marketing options are continually being presented to potential customers to ensure that the development of *least-cost systems is encouraged* (emphasis ours).

The extent to which a focus on profit translates into a concern to maximise efficiency will depend, among other things, on the intensity of competition as perceived by management. Where this is low, satisfactory profits may be earned at low absolute levels of operating efficiency. This may occur even where competitors are numerous if the management among competitors is of a poor quality. On the other hand, it is also the case that the potential for monopoly profits may be an incentive for innovation (Clarke and Porter 1982).

The pursuit of greater efficiency may threaten the principal focus of an organisation. To the extent that the pursuit of greater efficiency involves greater risk taking, for example, one would expect government bodies to be resistant, given the importance to them of being seen to make correct decisions. There is an incentive in government agencies to implicitly weight 'Type II' errors (acceptance of a new procedure which turns out to be faulty) more highly than 'Type I' errors (rejection of new, cost-saving procedures), because the former errors are more apparent to the public.

Whether an organisation with goals for greater efficiency innovates to achieve those goals depends on its capacity to do so. This will depend on its stock of human and financial resources relative to the demands on each made by various technological innovations available for adoption. For minor innovation, involving little investment and marginal changes to organisational operations, all forms of institutions are likely to enjoy adequate financial capacity. For major innovation, involving non-marginal changes to an organisation's operations, the financial resources an organisation has will influence its response to the risk: return features of innovations. Intervention by governments to

manipulate this response, by reducing the total risk or increasing the return associated with innovation, is commonplace in agriculture.

For all innovations, the nature of management will influence the extent to which innovation is employed to enhance efficiency. Some managers actively seek changes in technology; others regard changes as being a nuisance, an interruption. The latter are unlikely to seek it, or to manage its implementation effectively if change is thrust upon them. 'An activist managerial ideology; professional management orientation [notably including a risk-taking, optimising and planning emphasis]; managerial skills at planning, coordination and control; and the ability to be effective agents of change' (Khandwalla 1977:561) appear to be key determinants of the innovativeness of organisations.

While the existence of these management characteristics may vary widely across different organisations of the same type, the likelihood that they will exist is greater in some types than in others. Organisations other than private business firms are unlikely to attract personnel with the characteristics identified. At the same time, it is salient to note that business firms, particularly small ones (and cooperatives), may be poorly endowed with such characteristics. Where this is so one can expect innovation to be slow, unless intervention occurs.

In summary, private, profit-orientated business firms have much to commend them as the type of organisation with the greatest potential to pursue technological innovation naturally. If monopoly practices are a problem, this potential *may* be reduced considerably and, even if it isn't, the distribution of the benefits flowing from innovation are unlikely to serve social goals. Also, small business firms cannot be assumed to share the potential with large firms. Cooperatives have a lesser potential but have generally more attractive characteristics in terms of the distribution of benefits from innovation. A priori, government bodies have little to commend them as potential innovators: incentives are likely to be for non-innovation, and the human resources unlikely to be of the appropriate type (Clarke and Porter 1982).

Market Failure and the Public Interest

As explained by Brennan (1983), the theory of market failure is well developed. There are a number of scenarios, such as decreasing-cost production technology, which economists can point to as situations in which markets will not work very well. In such situations, governments are prone to replace private agents with bureaucracies of various sorts, without knowing whether those bureaucracies will do a better job than the market. This characteristic of governments has been as true in agricultural

marketing as in other areas of economic activity. Brennan explains that it has been only in recent years that economists have developed some theories about how bureaucracies work, and that governments should not *assume* that they will do better than the market. What is of considerable concern is the fact that bureaucrats probably do not embrace the notion of 'acting in the public interest' nearly as closely as one would wish. The essence of the problem is captured in the following remarks from Tullock (1983:4):

Bureaucrats, and for that matter their political 'masters', . . . are much like other men. There are among them scoundrels and saints, but both are rare. The average bureaucrat or politician is not markedly different from the average businessman or college professor. They are, like the rest of us, to some extent interested in the public good and in helping their fellow-men; but like the rest us, they put far more time and attention into their private concerns. Thus the bureaucrat, in making a decision about some matter, is likely to give more weight to the effect of his decision on his personal career than on the nation as a whole. These two categories are not, of course, necessarily in conflict, but sometimes they are. And then we must expect the bureaucrat, most of the time, to choose his personal well-being rather than the public good. These common human characteristics affect the function of the institution or institutional framework he is working in.

These thoughts about bureaucrats would be of less concern were it possible to make them more accountable for their actions. However, this is not a simple task because it may involve fundamental institutional changes and greater resort to competition and private ownership than governments are prepared to allow (Clarke and Porter 1982).

Price Policy Considerations

In this section, comments are made on two issues: the problems faced by marketing organisations in the exercise of countervailing power and the problems they face in achieving stability objectives.

Countervailing Power

The problems faced by cooperatives in trying to increase farmers' bargaining power are well known and have been analysed by Helmberger and Hoos (1965). These problems, particularly that of 'free-riders', have resulted in farmers seeking the element of compulsion in marketing bodies: marketing boards with monopoly powers have been established in an attempt to secure the sorts of gains, particularly higher output prices, which voluntary cooperatives were unable to achieve. However, merely introducing the element of compulsion is not a sufficient condition for success in achieving higher

prices. Piggott (1981) provides an analysis of the pre-conditions that need to be met before a marketing board can secure higher returns to farmers through supply limitation. These conditions are stringent. As a generalisation, it can be said that proponents of marketing boards as agencies for exerting market power often underestimate the elasticity of demand faced by these organisations. Also, they fail to appreciate the importance for the success of these organisations of their being able to offer excludable benefits from participation. Marketing agencies have sometimes been established to exert countervailing power in situations where private agencies involved in handling farmers' products operated in a highly competitive manner (Moore 1968). In such situations there is likely to be little in the way of rents to be captured by marketing bodies wielding 'countervailing power'.

Stability Objectives

The quest for more stability in agricultural markets has led to a wide variety of intervention measures implemented through various types of marketing agencies. One problem in the pursuit of stability objectives is that the precise nature of these objectives is rarely spelled out in detail [see, for example, Myers et al. (1985) for a discussion of lack of clarity in the stability objectives of the Australian Wheat Board]. This is important given that increased stability for one market variable may result in decreased stability for another, or it might impact upon the general level of farmers' returns. For example, in the Australian context, a great deal of research attention has been given to the so-called 'hidden revenue losses and gains' accruing to wool producers as a result of the buffer-stock scheme operated by the Australian Wool Corporation (Campbell et al. 1980; Haszler and Curran 1982; Richardson 1982). Some other issues of concern in the pursuit of stability objectives include: (i) the efficacy of using *price* policy to achieve *income* stability objectives, given that farmers frequently produce several crops and that yield variability can be an important determinant of income variability; (ii) the problem of achieving revenue stability when only a portion of the crop is marketed; and (iii) whether increased stability at the industry level does much to stabilise the environment of individual producers. Tomek (1969) and Houck (1973) provide useful discussions of these matters.

In its most recent *World Development Report*, the World Bank (1986) is critical of the role which some government and parastatal agencies have played in marketing and market stabilisation. It suggests that more could be done for farmers by improving the legal and institutional environment for private markets, and eliminating parastatal

marketing monopolies. Indeed, there is some evidence that government agencies have been destructive of competitive private marketing, in that private traders are forced out of the market through lack of opportunities to earn an adequate return (World Bank 1986:88). Such would seem to be the case in Indonesia, where the price stabilisation arrangements implemented by BULOG have forced some private traders out of the storage function because the margins between floor and ceiling prices were set too narrowly (Falcon et al. 1986). Also, there are instances of management making fundamental managerial errors, such as not explaining the precise meaning of an announced floor price. Farmers are surprised when the price they are offered at the cooperative is less than the floor price because of moisture content and other reasons, and they lose confidence in their cooperative as a result. Sometimes it is difficult to maintain floor prices because buyers, including cooperatives, lack the credit (because of credit regulations) necessary to make purchases, or because cooperative buying agencies are inconveniently located.

The pursuit of stability objectives is a complex task even when those objectives are well defined. Success in achieving them requires futuristic and managerial skills which, based on the previous discussion of incentives, one does not expect to find in too many non-private marketing agencies. The fact that these objectives, as set by policy makers, frequently lack internal consistency means that it is perhaps unfair to criticise marketing agencies for the problems they have in trying to achieve them.

Alternative Marketing Organisations and Smallholder Agricultural Development

In this section, attention is given to published evidence relating to the effects of different marketing organisations on smallholder agricultural development, focusing on farm-gate prices, market risk, and equity. It is generally conceded that governments in developing countries have a role to play in promoting economic development and, given the importance of smallholder agriculture in developing countries, its progression is usually a key component of economic development plans. The authors believe the evidence to be provided here is consistent with the generalisations made in the previous sections.

Reference was made earlier to the automaticity with which governments create bureaucracies to undertake marketing functions when market failure threatens or is thought to exist. At the outset it is worth mentioning that, in fact, this tendency seems to have gone a step further in many developing

countries: the onus seems to be on protagonists of private marketing institutions to demonstrate that they would perform particular marketing functions better than public institutions, rather than the reverse (Harriss 1982a).

Some findings with respect to the competitiveness and efficiency of different organisations follow.

(i) Sectors dominated by private marketing institutions have generally been found to be quite competitive (Harriss 1977; Jones 1984; Siamwalla 1978), although obviously the degree of competitiveness varies across commodities and marketing systems.

(ii) There is a strong case for supporting private marketing entrepreneurs in grain handling to minimise marketing costs (Harper and Kavura 1982). However, they should not be protected from failure, which is a necessary part of the 'natural selection' of innovations which consumers and others in the marketing system desire (Greenfield and Strickon 1981).

(iii) While cooperatives appear to hold philosophical and political appeal, they have rarely succeeded in providing more efficient grain handling services than private agents for the usual litany of reasons (Abbott 1978; Mittendorf 1981; Pyakuryal 1972). It is not true to generalise, however, that small farmer marketing cooperatives are doomed to failure and there are some well-documented success stories in grain handling (ESCAP 1983; FAO 1984). A key set of conditions needs to be satisfied for those cooperatives to succeed (Peterson 1982).

(iv) Statutory marketing boards and parastatal marketing organisations participating in grain handling in developing countries have been generally observed to be inefficient. Principal causal factors identified include lack of management expertise; high fixed costs (Harper and Kavura 1982), ignorance of day-to-day decision making, bureaucratic rigidity, and political constraints (Harriss 1977). Symptomatic of the poor performance of these institutions has been a general failure (resistance?) by governments to evaluate their performance, despite the key role attributed to them in agricultural market development (Abbott 1978).

(v) There has been a tendency for bureaucratic expansion to proceed unchecked in the grain handling sector, despite apparent poor performance. Ellis (1983), Harper and Kavura (1982), and Harriss (1982a) have all observed this phenomenon. They regarded it as a natural outcome of bureaucratic behaviour and were pessimistic about the chances of reversing this trend.

(vi) At best, statutory marketing boards and parastatal marketing organisations effectively provide only partial competition for private

marketing institutions (Harriss 1982a; Harper and Kavura 1982; Kaberuka 1984).

Not a great deal of analysis has been undertaken of the ways in which different marketing organisations innovate and adopt cost-saving technologies in the grain handling sector in developing countries so as to improve farm-gate prices. The evidence available suggests that private market participants have provided an important conduit for the introduction of numerous small improvements in marketing technologies which, while they have only a marginal effect individually, have a substantial cumulative impact on marketing costs over time (ESCAP Secretariat 1975; Lee 1983). It is pertinent to note that major innovation is discouraged if violent changes in conditions are expected. Sudden and considerable changes of government policy, for example, impede innovation (Carter and Williams 1971).

On the other hand, cooperatives do not appear to have been good vehicles for the introduction of improved marketing technology, despite evidence that they are amenable to suggestions on improved marketing procedures (Abbott 1978). Even the success stories which have been chronicled demonstrate that cooperatives have used existing methods and have not been successful in introducing better technologies.

On the weight of evidence surveyed, private marketing institutions appear to be the best organisations to maximise prices at the farm gate for small grain producers. Sometimes small farmer marketing cooperatives might perform successfully. However, state intervention in the participative function of grain handling sectors appears the worst option to choose.

In respect of price risk, Siamwalla (1978) argued that private marketing institutions perform a valuable speculative role in grain and other markets. By their actions, they take on much of the risk associated with price fluctuation, usually at the expense of other (not so good) speculators. He argued that this function has a much greater influence on middlemen profits than allocative efficiency. On the other hand, he noted that government intervention has not been successful in dampening fluctuations in market price, a view supported by Harper and Kavura (1982). No evidence was available on the role of cooperative marketing enterprises in assuming market price risk which otherwise would be felt by small grain producers.

Another form of market risk faced by small farmers is unreliability in the provision of marketing services. The evidence favours a competitive private marketing environment as the best means of ensuring that farmers have regular access to reliable

services (e.g. Harper and Kavura 1982:106). Leonard (1980) has pointed up the risks small producers face when they have a monopsonistic and inefficient marketing enterprise as the only outlet for the surpluses. Commonly, this enterprise is a public marketing institution.

A review of the literature on equity aspects supports Schaffer's proposition of 'the irony of equity' (Schaffer and Lamb 1981:3). Government intervention in grain handling is designed to correct 'inequity' caused by the operations of, and rules enforced by, private marketing institutions. The irony lies in the outcome of this intervention: further inequity and exclusion from markets. The complexity of smallfarmer production-distribution systems presents a set of problems to statutory marketing boards which is insoluble without the participation of small, private marketing traders (ESCAP Secretariat 1975; Harper and Kavura 1982; Harriss 1977). The boards are, by themselves, ill-equipped to deal with the surpluses of many small producers.

There is considerable evidence of urban bias in the operations of statutory marketing boards in grain marketing. Ellis (1983) and Gerrard (1983) have both demonstrated how these boards extract surplus from small farmers to support a proliferating state and parastatal bureaucracy. On the other hand, there is accumulating evidence that small farmers are not disadvantaged relative to large farmers in the operations of private marketing institutions (ESCAP Secretariat 1975; Harriss 1977; Harriss 1982c; Wiegand et al. 1985). Siamwalla (1978) argues that there is a case for promoting small farmer marketing cooperatives where there is a lack of private traders.

Facilitative Functions

Of all the potential functions to be performed by public institutions, 'facilitative functions' prove the least contentious. Neoclassical economists, in particular, feel more relaxed about government involvement to *help* private and (voluntary) cooperative market participants undertake various handling activities. The importance of facilitative functions has been stressed (ESCAP Secretariat 1975; Fox 1979; German Foundation for International Development 1978; Jones 1984; Mittendorf 1981; Schaffer 1972). However, there have been some mildly dissenting voices. Abbott (1978) posed the awkward question of whether the facilities provided are actually used, given other constraints on market participation. Harper and Kavura (1982:106) considered that the provision of facilitative functions by government is of minor importance: its usefulness lies merely in helping 'to create an environment which is conducive to the

establishment and growth of (private entrepreneurial initiatives)'.

Despite these reservations, there appears to be agreement for government involvement in providing facilities and services of a public good nature. The facilitative function should encourage competition and ease the adoption of new technologies, thereby minimising marketing margins and ensuring the best return to small producers. Improved infrastructural services and better market information can help small producers deal with market price fluctuations and ensure more reliable marketing services. There can also be equity implications. As new or improved market facilities and services reach more remote small producers, their capacity to participate in grain handling sectors by supplying a larger surplus is enhanced. Nevertheless, while government involvement may be necessary in the discharge of facilitative functions, the involvement of statutory marketing boards is unnecessary.

There is support in the literature for governments to become involved in regulatory functions where market participants need to be dissuaded or prevented from antisocial behaviour (e.g. ESCAP Secretariat 1975; Harriss 1977; Jones 1984; Lee 1983; Lele 1981). Harper and Kavura (1982) considered such involvement in grains marketing was inevitable given the political sensitivity of marketing of basic food commodities in developing countries. Harriss (1977) considered that this was the most successful kind of government intervention in grain marketing in India.

Such intervention has not been without its problems. The German Foundation for Developing Countries (1972) and Harper and Kavura (1982) observed the potential for discord between bureaucrats enforcing regulatory functions and private market participants. These views reinforce those of Tullock (1983) quoted earlier. Another problem relates to equity concerns. There is evidence that government intervention can benefit private monopolies, oligopolies, or large trading organisations at the expense of small market participants (Abbott 1978; Harriss 1977). Problems may also arise from the regulatory role of government through the implementation of misguided agricultural pricing policies which discourage private market participation (Mittendorf 1981). Also, Siamwalla (1978) has observed misgivings by private market participants about the honesty of government personnel discharging regulatory functions. Even where the personnel are honest, their competence has been questioned at the local government level. Local governments are usually charged with the responsibility of regulating operations in rural assembly markets which are bypassed by larger suppliers or traders (Lee 1983).

Siamwalla (1978) felt that the only area in which the private marketing system was inimical to the interests of small farmers was in weighing and grading. Therefore, lack of competence in regulatory functions in these markets adversely affects small market participants and producers most.

Finally, a cautionary note has been sounded by some analysts in terms of the scope for redressing inequities in agricultural economies through regulation. Harper and Kavura (1982), Harris (1977, 1982b) and Sau (1975) have all expressed reservations about the influence of market reforms through government regulation because of the overriding effects of production relations. It is production relations which most reinforce existing inequities, and market reforms without production reforms are likely to be ineffective.

Anticipative Functions

'Anticipative' market functions (market research, forecasting, etc.) have been largely ignored when considering the case for government intervention in marketing. They are complementary to facilitative functions and do not require statutory marketing boards. The case for more government involvement in market research and forecasting has been put by, among others, Harper and Kavura (1982) and Mittendorf (1981). It rests on three grounds. First, farm-gate prices can be lowered by research into improved methods of marketing. Second, forecasting services should enable farmers and market participants to better anticipate future changes in the market, thereby reducing market risks. Third, government is in a position to bias market research into new marketing technologies which are labour-intensive and appropriate to small farmers and traders.

Conclusions

It is inevitable that agricultural marketing systems will depart from the *laissez-faire* model. What is of concern is that farmers, consumers, and governments are often unrealistic about what can be achieved by departures from this model. Economic facts-of-life tend to be overlooked, including the incentives to which decision makers in various marketing agencies respond. In general, governments tend to be too hasty in encouraging departures from the *laissez-faire* model.

Cooperatives in the humid tropics typically develop under government auspices and are highly regulated (Peterson 1982). This causes them to possess different characteristics and incentives than those which emerge autonomously. An important characteristic they often appear to lack is the distributional one. This, coupled with lower

efficiency than private business organisations, led Peterson (1982:112) to argue that 'when [managerial skills or controls are] absent . . . private enterprises, despite their shortcomings as vehicles of equity, are likely to outperform cooperatives' in terms of providing small producers with access to efficient services.

It appears from the review of available evidence that state intervention in grain markets is most beneficial to small-farmer development in the facilitative and anticipative functions. Also, governments have a role to play in the discharge of certain regulatory functions. None of these functions requires the use of statutory marketing boards. The comparative advantage of government agencies is least in the participative function. It would be logical, therefore, for governments to commit resources for direct participation in grain handling only after ensuring that the other preferred functions have been effectively undertaken. Even then, it is important that the managerial capacity be adequate to ensure efficient participation. As Mittendorf (1981) concluded, managerial capacity is more important than organisational form in market participation. In developing countries skilled management can be a very scarce resource and, as Kaberuka (1984) suggests, governments should keep this in mind when promoting or establishing various organisational forms in agricultural marketing.

Acknowledgments

The authors acknowledge the research assistance provided by Jane Sefton and Elaine Treadgold, and useful comments from Joe Remenyi, ACIAR.

References

- Abbott, J.C. 1978. Technical assistance in marketing: a view over time. Presented at International export consultation, marketing and rural development conference. November 1977, Feldafing.
1985. Alternative forms of marketing enterprise for the developing countries. Presented at International Association of Agricultural Economists Conference. August 1985, Malaga, Spain.
- Babcock, H.E. 1935. Cooperatives — the pacesetters in agriculture. *Journal of Farm Economics*, 17, 153-156.
- Blandford, D. 1979. West African export marketing boards. In: Hoos, S. ed., *Agricultural marketing boards — an international perspective*. Cambridge, Massachusetts, Ballinger Publishing Company, 121-149.
- Brennan, G. 1983. Discussion. In: Tullock, G., et al. *The economies of bureaucracy and statutory authorities*. Sydney, St Leonards Centre for Independent Studies, Policy Forums 1, 93-94.
- Campbell, K. 1973. The state marketing board — relic or prototype? *Australian Journal of Agricultural Economics*, 17, 179-188.
- Campbell, R., Gardiner, B., and Haszler, H. 1980. On the hidden revenue effects of wool price stabilisation in Australia: initial results. *Australian Journal of Agricultural Economics*, 24, 1-15.
- Carter, C.F., and Williams, B.R. 1971. *Investment in innovation*. London, Macdonald, 125 p.
- Clarke, R., and Porter, M.G. 1982. State enterprise accountability: a contradiction in terms? In: Quangos — the problem of accountability. Melbourne, Monash University Centre of Policy Studies, Special Study No. 3, 47-69.
- Ellis, F. 1983. Agricultural marketing and peasant-state transfers in Tanzania. *Journal of Peasant Studies*, 10, 214-242.
- ESCAP 1983. *Small farmer group marketing in Asia*. Bangkok, Economic and Social Commission for Asia and the Pacific, 62 p.
- ESCAP Secretariat 1975. Problems of marketing of small farmers in the ESCAP region. *Economic Bulletin for Asia and the Pacific*, 26(2/3), 1-19.
- Falcon, W.P. et al. 1985. Rice policy in Indonesia, 1985-1990 — the problems of success. Falcon Team Report to BULOG, Jakarta.
- FAO 1984. *Small farmer marketing improvement in Asia*. Bangkok, Food and Agriculture Organisation of the United Nations, Regional Office for Asia and the Pacific, 117 p.
- Fox, R. 1979. Potentials and pitfalls of product marketing through group action by small-scale farmers. *Agricultural Administration*, 6, 305-316.
- Galbraith, J.K. 1952. *American capitalism: the concept of countervailing power*. Boston, Houghton Mifflin, 320 p.
- German Foundation for Developing Countries 1972. *The role of the entrepreneur in agricultural marketing development*. Rome, Food and Agriculture Organization of the United Nations, 31 p.
- German Foundation for International Development 1978. *Marketing: a dynamic force for rural development*. Berlin, 52 p.
- Gerrard, C. 1983. Government-controlled food grain markets, external trade in food grains and agricultural development: the case of four countries in East Africa. In: Maunder, A., and Ohkawa, K., ed. *Growth and equity in agricultural development*. Aldershot, Gower, 560-570.
- Greenfield, S.M., and Strickon, A. 1981. A new paradigm for the study of entrepreneurship and social change. *Economic Development and Cultural Change*, 29, 467-499.
- Harper, M., and Kavura, R. 1982. *The private marketing entrepreneur and rural development: case studies and commentary*. Rome, Food and Agriculture Organization of the United Nations, 115 p.
- Harriss, B. 1977. Piecemeal planning in rice markets: the effects of partial government intervention on marketing efficiency in a South Indian Village. Norwich, University of East Anglia, Monograph in Development Studies No. 1, 411 p.
1978. Allocation, location and dislocation in non-market rice distribution. *Journal of Development Studies*, 15, 87-105.
- 1982a. *Agricultural marketing in the semi-arid tropics*

- of West Africa. Norwich, University of East Anglia, Development Studies Occasional Paper No. 17.
- 1982b. The process of the commercialisation of agricultural commodities in India. Norwich, University of East Anglia, Development Studies Discussion Paper No. 108.
- 1982c. The marketed surplus of paddy in North Arcot district, Tamil Nadu: a micro level causal model. *Indian Journal of Agricultural Economics*, 37, 145-158.
- Haszler, H., and Curran, B. 1982. On the hidden revenue effects of wool price stabilisation in Australia: initial results — a reply. *Australian Journal of Agricultural Economics*, 26, 66-71.
- Helmsberger, P.G., and Hoos, S. 1965. Cooperative bargaining in agriculture. Berkeley, University of California, Division of Agricultural Services, 210 p.
- Houck, J.P. 1973. Some aspects of income stabilisation for primary producers. *Australian Journal of Agricultural Economics*, 17, 200-215.
- Jones, W.O. 1984. Economic tasks for food marketing boards in tropical Africa. *Food Research Institute Studies*, 19, 113-138.
- Kaberuka, D.P. 1984. Evaluating the performance of food marketing parastatals. *Development Policy Review*, 2, 190-216.
- Khandwalla, P.N. 1977. Design of organisations. New York, Harcourt Brace Jovanovich, 713 p.
- Krueger, A.O. 1974. The political economy of the rent-seeking society. *American Economic Review*, 64, 291-303.
- Lee, C.Y. 1983. Removing marketing constraints in rural development. Presented at Conference on small farmer marketing improvement in Asia. June 1983, Bangkok.
- Lele, U. 1981. Cooperatives and the poor: a comparative perspective. *World Development*, 9, 55-72.
- Leonard, D.K. 1980. Disintegrating agricultural development. *Food Research Institute Studies*, 19, 177-186.
- McCalla, A.F., and Schmitz, A. 1979. Grain marketing systems: the case of the United States versus Canada. *American Journal of Agricultural Economics*, 61, 199-212.
- Mittendorf, H.J. 1981. Useful strategies for developing countries striving to improve food marketing systems. In: Johnson, G., and Maunder, A., ed. *Rural change: the challenge for agricultural economists*. London, Gower, 131-144.
- Moore, J. 1968. Bargaining power potential in agriculture. *American Journal of Agricultural Economics*, 50, 1051-1053.
- Myers, R.J., Piggott, R.R., and MacAulay, T.G. 1985. Effects of past Australian wheat price policies on key industry variables. *Australian Journal of Agricultural Economics*, 29, 1-15.
- Pasour, E.C., Jr., and Bullock, J.B. 1975. Implications of uncertainty for the measurement of efficiency. *American Journal of Agricultural Economics*, 57, 335-339.
- Peterson, S.B. 1982. Government, cooperatives, and the private sector in peasant agriculture. In: Leonard, D.K., and Marshall, D.R., ed. *Institution of Rural Development for the Poor*. Berkeley, Institute of International Studies, 73-124.
- Piggott, R.R. 1981. Agricultural selling cartels: relative cooperator and non-cooperator gains. *Australian Journal of Agricultural Economics*, 25, 14-29.
- Pyakuryal, K.N. 1972. Problems of cooperative marketing. Presented at Agricultural marketing conference. February 1972, Kathmandu.
- Richardson, R. 1982. On the hidden revenue effects of wool price stabilisation in Australia: initial results — a comment. *Australian Journal of Agricultural Economics*, 26, 63-65.
- Sau, R. 1975. The small farmer and the market, with special reference to rice and wheat in India. *Economic Bulletin for Asia and the Pacific*, 26(2/3), 20-28.
- Schaffer, B., and Lamb, G. 1981. Can equity be organised? Farnborough and Paris, Gower/UNESCO, 166 p.
- Schaffer, J.D. 1972. Designing agricultural marketing systems in developing countries. Presented at Agricultural marketing conference, February 1972, Kathmandu.
- Siamwalla, A. 1978. Farmers and middlemen: aspects of agricultural marketing in Thailand. *Economic Bulletin for Asia and the Pacific*, 29(1), 38-50.
- Sieper, E. 1982. Rationalising rustic regulation. Sydney, St Leonards, Centre for Independent Studies, 110 p.
- Stoney, I. 1986. Management viewpoint on institutional barriers to change. Paper (transcribed) presented to Rural Development Centre, University of New England, National conference on transport, storage and handling of Australia's agricultural commodities. May 1986, Artarmon, N.S.W.
- Timmer, C.P. 1975. The political economy of rice in Asia: Indonesia. *Food Research Institute Studies*, 14, 197-231.
- Tomek, W.G. 1969. Stability for primary products: means to what ends? Ithaca, N.Y., Cornell University Dept of Agricultural Economics, Occasional Paper No. 28, USAID Prices Research Project.
- Tullock, G. 1983. Public choice and regulation. In: Tullock, G. et al. *The economics of bureaucracy and statutory authorities*. Sydney, St Leonards Centre for Independent Studies, Policy Forums, 1, 1-12.
- Wiegand, K., Ansel, K., and Steen, D. 1985. Marketing, middlemen and peasant exploitation: the role of producers' preferences. Presented at International Association of Agricultural Economists' Conference. August 1985, Malaga, Spain.
- World Bank 1986. *World development report 1986*. New York, Oxford University Press, 256 p.

The Role of the Public Sector in Postharvest Technological Change

Chrisman Silitonga *

Abstract

This paper examines the role of the public sector in postharvest technological change, particularly in Asia. Asian countries produce about 93% of the world's rice, 87% of its wheat, and 62% of coarse grains. Increases in production, sometimes dramatic, have not always been matched by improvements in postharvest handling. Most farmers in Asia occupy small pieces of land, widely dispersed throughout the country. This dispersion, coupled with low income levels and poor technical skills, has made it difficult to improve handling of the harvest. The importance of improving postharvest technology is highlighted by the fact that more than 50% of world cereal stocks are held in developing countries.

The public sector has institutional, supervisory, and research and development functions in the postharvest arena. The form of intervention undertaken in exercising each of these important functions is stipulated by government. In some Asian countries, it is clear that lack of communication between government and farmers and inadequate supervision are still major constraints. For various reasons, some institutions have been unsuccessful at convincing farmers of the need to improve grain handling and storage techniques. However, some countries have been able to introduce technologies that have improved product quality and reduced losses. Application of postharvest equipment at the village level has led to reduced storage losses. Better quality milled rice has followed the replacement of older-type Engelberg rice mills with rubber roller types, which give a higher milling recovery. A strengthening of research and development cooperation between grain producing countries would enhance the transfer of useful technologies.

DATA collected by FAO (1985) indicate that world production of cereals increased continuously over the period 1973-1983.

In 1973, world production of cereals amounted to 1375 million tonnes. This had risen to 1643 million tonnes in 1983, an increase of about 19% over the 10-year period. As much as 54% of this production is from the developing countries. Regionally, Asia produced 749 million tonnes of cereals in 1983, or 46% of total world production.

The cropping area increased from 698.8 million ha in 1973 to 712.3 million ha in 1983, a rise of only about 2% in 10 years, far less than the increase in production. This means the increase in production over the period arose from a dramatic increase in productivity following the application of new technology in the form of high yielding varieties,

fertilisers, pest and insect control, and improved irrigation systems and farming techniques.

As regards the kind of crop, the production of cereals in 1983 consisted of paddy 450 million tonnes, wheat 495 million tonnes, and coarse grains as much as 698 million tonnes. Thus, the production of coarse grains, amounting to some 43% of the total, is still the most substantial commodity produced by the farmers all over the world.

Table 1 shows that Asia was the largest cereal producer in the world in 1983, displacing the USSR and America which were, in 1973, the largest producers of wheat and coarse grains, respectively. As a result of the increase in production of wheat in Asia the developing countries contribution to world production rose from 28% in 1973 to 39% in 1983, while their contribution to coarse grains production increased from 31% to 38%.

The FAO data in Table 1 also show that as much as 688 million tonnes or 42% of world cereal

* National Logistics Agency (BULOG), Jl Gatot Subroto 49, Jakarta, Indonesia.

TABLE 1. World cereal production ('000 tonnes) by region, 1973 and 1983.

Region	1973			1983		
	Rice	Wheat	Coarse grains	Rice	Wheat	Coarse grains
Asia	305 633	88 221	116 267	417 469	169 619	162 009
Africa	7 261	8 591	40 521	8 912	8 909	45 736
America	16 010	74 815	258 184	19 123	111 838	156 442
Europe	1 980	82 432	139 911	1 732	103 434	153 636
USSR	1 765	109 784	102 534	2 600	78 500	105 798
Oceania	327	12 363	5 132	573	22 389	9 153
World total	332 976	376 206	662 549	450 409	494 689	632 774
Developing countries total	311 934	106 592	202 648	428 045	195 120	267 185
Developed countries total	24 042	269 614	459 901	22 364	299 286	431 286

Source: FAO (1985).

production in 1983 came from countries categorised as low-income food deficit countries.¹ These countries meet food requirements through imports and food aid. The amount of food aid to these countries increased from around 13% in 1973 to 18% in 1983.

After taking into consideration the amount of cereals consumed and marketed (imports and exports), it is estimated that, in 1983, some 264 million tonnes of cereals were stored as world stock, 120 million tonnes in the developing countries and 144 million tonnes in the developed countries. The amount of stock is thus distributed roughly equally between developing and developed countries, in spite of the wide difference in level of technology between them.

The foregoing picture of production by commodity and area over the past 10 years highlights where the main problems lie.

Both production and postharvest problems involving cereals are mostly centred on the Asian region. The greater part of Asia consists of developing countries with an average per capita income below US\$500 per year.

The most important cereal grown in Asia is rice. Cereals in Asia are produced by large numbers of smallholder farmers with a relatively low level and application of technology. As approaching 50% of the world cereal stocks are held in developing countries, the problem of storing and maintaining quality of these stocks is a high priority problem faced by farmers and stocking agencies in developing countries.

The Nature of the Postharvest Problem

The increase in production of cereals that occurred during 1973-1983 was not sufficient of

itself to improve the living of the farmers. In fact, the increase in production exacerbated the postharvest problem. The importance of the problem of postharvest handling has been given serious attention by FAO. During the commemoration of World Food Day II in 1982, the theme 'Food Comes First' was chosen, with the aim of drawing attention to the need to improve postharvest handling practices.

The postharvest problem in the developing countries, particularly those in Asia, is very much influenced by endemic agricultural practices, as follows:

- Food farming, especially of paddy, is categorised as mass farming and each decision taken individually by a member of the family can change the food farming system. Postharvest activities are handled cooperatively by the farmers. In Indonesia, for example, paddy is harvested by a number of harvesters who will be paid in kind by the owner of the paddy. The number of harvesters available is considered more important than their skill. The harvesters do not bear any risk of harvest losses.
- Food is produced on small parcels of land located in the remote village areas scattered throughout the country. Without the application of pre-production and postharvest technology, the farmer has difficulty in commercialising his production. The small land size can generally only supply the food needs of the household.
- Farmers in Asia very much depend on the season that will supply water for paddy farming. Irrigation technology that can guarantee a supply of water throughout the year is still too expensive for most developing countries.
- Because they have only small pieces of land which are dedicated to supplying most of the

¹ The World Bank categorised countries with a per capita income below US\$790 in 1983 as low-income food deficit countries entitled to food aid.

food for the household, farmers are slow to apply new technology and very careful to avoid the risk of harvest failure.

- The Asian countries are the largest producers and consumers of rice in the world. The quantity of rice they sell on the international market continues to increase from year to year. (According to FAO estimates, the export of rice from Asia has increased by 70% during the past 10 years or so, from 5.2 million tonnes in 1974 to 8.8 million tonnes in 1984.) The export of rice from the developing countries alone in that period increased by 56%. Indonesia became a newcomer to the ranks of rice exporters in 1985, when it exported some 400 000 tonnes to various countries. New exporters face the problem of price and quality competition on the international market.
- The income level of farmers in Asia is low. Without government intervention in farm produce marketing it is difficult for farmers to improve their economic level. The poverty of Asian farmers limits the efforts that farming families can make to improve the quality of their products. Government intervention at all stages of marketing, especially of paddy, is common in Asia.

The characteristics of agriculture and farmers in Asia, and in developing countries in general, determine the pattern of postharvest problems. The combination of various natural factors, level of

TABLE 2. Estimated losses of weight in commodities stored for varying periods in a number of countries.

Country	Commodity	Amount of loss (%)	Duration of
			storage (months)
India	Grains	20	12
Malaysia	Rice	17	8-9
Thailand	Paddy	10	—
Nigeria	Wheat	34	24
Ghana	Beans	9.3	12

Source: Hall (1971).

TABLE 3. Estimated losses (%) at various stages in the postharvest chain, in different regions of Indonesia.

Stage	Region											
	Aceh			West Java			South Sulawesi			South Kalimantan		
	Max	Min	Mean	Max	Min	Mean	Max	Min	Mean	Max	Min	Mean
Reaping	1.3	0.1	0.5	6.4	0.6	1.8	3.2	0.2	1.2	4.9	0.8	1.6
Threshing	2.0	0.0	0.4	4.7	0.1	0.5	7.4	1.5	3.5	4.2	0.0	1.0
Cleaning	2.3	0.0	0.3	—	—	—	—	—	—	0.5	0.0	0.1
Drying	0.1	0.0	0.0	—	—	—	—	—	—	1.0	0.0	0.0
Storage	2.1	0.2	0.3	4.2	0.8	0.6	0.9	0.3	0.4	5.9	0.4	0.5
Transportation	0.0	0.0	0.0	0.0	0.0	0.0	0.0	0.0	0.0	0.0	0.0	0.0
Rice Milling	4.5	0.0	0.8	4.5	0.0	0.7	4.5	0.0	3.5	4.5	0.0	1.9

Source: Study Report on The Postharvest Losses in the Republic of Indonesia. Japan International Cooperation Agency, August 1982.

technology, skill, income, the behaviour of the farmer and consumer, and the marketing system, specify the problems faced, and at the same time suggest appropriate solutions. The major postharvest problems, in the Asian context, are summarised in the remainder of this section.

Quantitative and qualitative losses of foodgrains from harvest to storage level are still relatively high compared with the developed countries. In Indonesia, for example, according to research carried out by various agencies, losses of rice between 12.3 and 21% occur during storage. Table 2 lists some estimated storage losses for various cereals in a number of countries.

The information regarding the amount of losses at each stage of the postharvest chain is still limited. In Pakistan (Abdul Malik 1985), preharvest losses of paddy are estimated at 0.69-1.11%. Losses at the time of threshing (manual) can reach 3%. Traditional cleaning practices cause further losses of 0.76-2.57%. Losses during storage are estimated at 8.75%. In Indonesia, losses of 12.3-21% are made up as detailed in Table 3.

The greatest losses (at farmer and trader levels) occur during storage and can be related to inadequacies in processing before storage, such as imperfect drying. Mechanical drying is relatively labour saving, but needs support facilities which are relatively capital intensive and beyond the means of farmers. Sun drying is still favoured by most farmers because of its low cost and because it does not need a complicated physical handling system. However, traditional sun drying results in relatively high losses. Farmers do not always know the best level to dry to, so that when paddy is subsequently stored, discoloration of the grain occurs which in turn results in poor quality and a reduced price for the product. Until quite recently in Indonesia, especially in the Province of Aceh, farmers piled newly harvested paddy for some 9-10 days in the field before threshing it. At the time of drying, most of the paddy had already experienced a heating process that resulted in yellowing in the rice milled from it.

The price received for such rice was about half the prevailing market price. Farmers in developing countries seem to be much more concerned with the business of harvesting than with the quality of the crop and its subsequent fate. They are not sufficiently aware of the importance of proper handling following a good harvest if they are to obtain the highest monetary returns for their products. A study (Anon. 1985) carried out in Indonesia showed that large numbers of farmers were not aware that losses occurred. Some 76% of farmers surveyed were unaware of the existence of preharvest losses, 87% of losses at the reaping stage, 66% of cleaning losses, and 63% of losses at drying. This led the government to continue its program of extension and field demonstration activities on recommended postharvest practices at the farm level.

Different sociocultural backgrounds reflect farmers' attitudes in formulating solutions to postharvest problems. In a conservative society which deeply believes in tradition, it is difficult to accept the changes that would relieve the existing problems in postharvest handling. For example, in some places in Indonesia, to change the planting cycle in order to avoid insect and disease problems is considered as a threat to the future. It would mean breaking the traditional cycle which has been practised for generations. To do this is considered detrimental by the people, despite the evidence to the contrary that experts can present to the farmers. Close relationships and cooperation between farmers often makes them hesitant to reveal losses to their fellow society members. This attitude forestalls the achievement of the higher productivity which should follow the application of new technologies. Farmers who are interested in immediate cash payments for their paddy are not particularly interested in overcoming postharvest problems. The system of buying beforehand in Indonesia — that is, the paddy is sold before it is harvested — results in the buyers, rather than the farmers, taking over the postharvest risks and costs. The need to sell the harvest immediately, while the paddy is still in the field, arises from the poverty of farmers. It is also influenced by the obligation of the farmer to repay debts/credits incurred during the growing season, and by the shortage of labour in rural areas during the peak harvest time.

Superior, high yielding varieties (HYVs) introduced to replace the local variety need to be adapted to the local conditions. The superior varieties can also yield superior losses. The

occurrence of pests and diseases which spread at the beginning of the 1970s in various countries in Asia showed how sensitive HYVs are to the conditions in the new environment and necessitated new postharvest measures.²

Transportation facilities (roads and type of transport) between production areas and storage centres add further difficulties to overcoming losses. Transport facilities at village level still rely on manpower. In Indonesia, losses during transportation at the village level can reach almost 2% (Anon. 1982). These losses are exacerbated if hooks are being used at harbours and granaries. Due to the distance between warehouses, the need to speed up loading/unloading is often made as an excuse to mistreat bags, without considering the consequences of great losses thereby incurred. In Thailand, according to a study in 1979 (Anon. 1976), losses in handling and transportation amounted to 5%, the largest amount in the postharvest chain.

Storage problems are the largest contributors to losses in quantity and quality as well as nutritional value. All these losses result, in the end, in monetary losses. Most of the traditional rice-growing areas of the world lie in the humid tropics, with a climate characterised by high average temperatures (around 30°C) and relative humidities (around 85%). Under these conditions, grain (whether stored as paddy or milled rice) at equilibrium tends to absorb moisture from the atmosphere at more humid times of the day. Unless the storage is adequately ventilated, spoilage may result from increased respiration of moulds in the grain, accompanied by local heating and possible fermentation. Aeration (forced ventilation) permits equalisation of moisture content throughout the bulk of the stored grain and also reduces its temperature, thereby tending to reduce respiration and spoilage. Paddy is commonly stored either in the form of bundles of panicles, in sacks or plastic bags, or in bulk storage. The sacks or bags provide a means of separating varieties for specific milling requirements. However, they deteriorate with use and allow access to insects and rodents, particularly if not properly stacked, if handled with hooks, and if storage hygiene is not adequate. Bulk storage, if properly organised, is efficient and relatively inexpensive. However, its efficient operation requires considerable capital investment and trained manpower, both of which may not be available. Farmers and traders generally first store the crop immediately after harvest and some time afterwards part is sold and part is stored as food reserves for the family until the next harvest. Losses of rice during storage have been estimated at 2–6% for Southeast Asia (de Padua 1974), 6% for

² A more detailed discussion regarding this matter can be followed in U.S. National Academy of Sciences (1978).

India (Boxall and Greeley 1978), and 15% for Nepal (U.S. National Academy of Sciences 1978).

Because there are few postharvest extension workers and they are using methods of extension that are not particularly effective, it is difficult to get farmers, especially those living in remote areas, to accept the importance of postharvest problems. Such postharvest training as has been done has generally been limited to those who are seen as the key farmers in a district. Although it is expected that they will spread their knowledge to their neighbours, this does not always occur.

Governments in developing countries have financial limitations on servicing the postharvest needs/facilities of farmer groups as well as for rice millers. On the other hand, the credit supplied by financial institutions is not always easy to obtain. As a result, the farmer with his limited knowledge finds it difficult to assess and embrace the available technology.

The handling of postharvest problems in various countries very much depends on the status of that country in international markets. Countries categorised as exporters generally possess more skills to produce good quality food grains, because they have to compete with other countries to maintain their markets. This pushes the country concerned to apply postharvest technology quickly because it can also create cost efficiencies. In those countries which still struggle to satisfy their food requirements from local production, policies are orientated towards quantitative rather than qualitative targets. As a result, farmers and operators of postharvest equipment in food shortage countries have no incentive to improve product quality. It will sell whatever its quality. For their part, consumers can buy enough rice of low quality and price to meet the needs of the household. Engelberg-type rice mills with steel rollers produce a lower yield compared with rubber-roller mills. Because of the low yields and milling quality, the costs of postharvest handling in the developing countries can reach 40% of cost price in the local markets, or 50-60% in the international market. This means that support for improvement in product quality will be very much influenced by the consumer.

One of the other barriers to efforts to improve product quality is the difficulty in formulating national grain standards. The consumer selects the desired product on the basis of the variety of paddy and the physical appearance of its rice. These criteria of selection cause marketing inefficiencies and leave the producer in ignorance of the product standard problem. In buying the product from the farmers, the government determines a quality standard for long-term storage reasons, which has no extensive relevance as a common standard in the public

market place. Rice quality standards in various countries are summarised in Table 4. Unlike government standards, various rice standards implemented in public markets are familiar to those people who deal with rice. They have been traditionally used for daily transactions between buyers and sellers.

Government Policy on the Improvement of Postharvest Handling

Millions of farmers in Asia who act as managers of their farming businesses, generally occupy small parcels of land and face structural difficulties in postharvest handling. The need for immediate cash to cover living expenses forces them to quickly sell a large portion of their production which clearly leads them to be less involved in the postharvest sector. Consequently, the added value that should have been received by farmers falls into the hands of the buyers. This implies that, in spite of large increases in production, farm incomes have not improved. On the other hand, the traders — especially those who own processing equipment — will keep on increasing profits. Unless there are special policies, the welfare gap between the farmer and the rest of the society will widen.

Government intervention for the improvement of postharvest handling is indirect, because it is ultimately the farmers themselves who decide whether the directives made by the government are appropriate to them. The benefits to various parties are interconnected in the efforts of government to improve postharvest handling practices, as follows:

Farmers: can improve their incomes from the food production sector. If a farmer involves himself directly in the improvement of product quality, the sales value of his product will also be higher.

Owners of postharvest equipment: can reduce handling costs because they can more easily determine the quality preferences of the market and can increase the sales price of higher quality lines.

Consumers: get better nutritional value and have a stronger confidence in the market system.

Government: as a stockholder can store foods for a longer period and finds it easier to compete on the international market in terms of quality and price.

The strategy and role of government in achieving the above targets can be categorised in three ways:

1. institutional aspects
2. supervisory aspects
3. development and research aspects.

The form of intervention in each category is discussed in the next three sections.

Institutional Aspects

Institutionalisation is a form of government intervention to supervise those who deal with

TABLE 4. Standards and grades of rice in various countries.

Specification	Pakistan ¹	Burma ²		China ³			Indonesia ⁴	Japan ⁵			Nepal ⁶	Thailand ⁷	Malaysia ⁸
	(Basmati)	Super Ngasein 10%	Super Emata 10%	Gr. 1	Gr. 2	Gr. 3	Medium 1B	1st Gr.	2nd Gr.	3rd Gr.		(35% brokens)	(A3)
1. Admixture of other varieties													
(i) Fine grain varieties	5%	-	-	-	-	-	-	-	-	-	-	-	10%
(ii) Medium grain varieties	5%	-	-	-	-	-	-	-	-	-	-	-	-
2. Brokens (total)	7%	-	-	-	-	-	-	-	-	-	-	-	-
(i) 1/4 size to 1/2	4%	-	-	-	-	-	-	-	-	-	-	-	-
(ii) below 1/4 to 1/4	3%	-	-	-	-	-	-	-	-	-	-	-	-
3. Undermilled and red striped	2%	-	-	-	-	-	-	-	-	-	-	-	-
4. Chalky grain	4%	-	-	-	-	-	3%	-	-	-	-	10%	10% (+ immature grain)
5. Foreign matter	0.2%	-	-	-	-	-	0.05%	0	0.1%	0.3%	0.5%	1%	0.20% (+ seeds)
6. Paddy	0.2%	-	-	12g/kg	16g/kg	20g/kg	20g/kg	0	0	0	-	30g/kg	-
7. Damaged, shrivelled, and yellow grain, etc.	0.5%	-	-	-	-	-	1%	1%	2%	4%	3%	2%	4%
8. Moisture	14%	-	-	14.5%	14.5%	14.5%	14%	15%	15%	15%	14.5%	14%	14%
9. Milling standard/degree	-	1/4	1	80%	75%	70%	90-100%	100%	100%	100%	-	-	slightly undermilled
10. Head rice	-	75%	75%	-	-	-	-	-	-	-	-	-	65%
11. Big brokens (0.65 & above)	-	15%	15%	30%	30%	30%	63%	5%	10%	15%	16%	-	10%
12. Brokens (0.35 & above)	-	10%	10%	2%	2%	2%	35%	-	-	-	-	2%	25%
13. Foreign grain	-	-	6%	4%	6%	8%	2%	-	-	-	-	-	-
14. Millet with husk	-	-	-	50g/kg	70g/kg	80g/kg	-	-	-	-	-	-	-
15. Free from insects/fungi/moulds	-	-	-	-	-	-	yes	-	-	-	-	-	-
16. Free from bad smell	-	-	-	-	-	-	yes	-	-	-	-	-	-
17. Free from harmful chemical substances	-	-	-	-	-	-	yes	-	-	-	-	-	-
18. Coloured kernels	-	-	-	-	-	-	-	0	0.2%	0.2%	-	-	-
19. Discoloured grains	-	-	-	-	-	-	-	-	-	-	4%	-	-
20. Red and ungelatinised	-	-	-	-	-	-	3%	-	-	-	5%	4%	0.30%
21. Immature kernels	-	-	-	-	-	-	-	-	-	-	-	1%	-
22. Shrivelled kernels	-	-	-	-	-	-	-	-	-	-	-	1%	-
23. Yellow kernels	-	-	-	-	-	-	2%	-	-	-	-	1%	-
24. Split kernels	-	-	-	-	-	-	-	-	-	-	-	0.75%	-
25. Seeds	-	-	-	-	-	-	-	-	-	-	-	0.50%	-
26. Glutinous rice	-	-	-	-	-	-	-	-	-	-	-	0.50%	-

Sources: 1. Abdul Malik (1985)
2. U Than Tun (1985)

3. Fang (1985)
4. BULOG, Indonesia

5. Yoshitsuyu (1985)
6. Prabhat (1985)

7. Kruavan (1985)
8. Hashifah and Rohani (1985)

postharvest activities, develop better methods, monitor progress or problems in various aspects of the postharvest sector, and communicate directly with the farmers. The institutional aspect is therefore not limited only to the establishment of physical premises, but also covers the promulgation and implementation of statutes and regulations.

This aspect is considered very important because ultimately the government's concern is to improve food quality and reduce quantitative losses. On the other hand, millions of people who are primarily involved in these matters are constrained by some technical and financial difficulties.

In general, food crop agriculture is one of the economic systems that claims much of the attention of government, owing to its strategic position in enhancing the welfare of society. To most people, enough food implies a stronger economy. For farmers, the more food they produce, the better they are able to maintain their normal standard of living. Since the majority of people are farmers, however, this implies that the strength of the national economy is much more dependent upon their ability to produce more food. Consumers change their demands for food in term of amount and quality due to changes in income and taste. However, farmers are not able to respond to market demands immediately, and adjust only slowly to changes in demand resulting from changing consumer tastes.

During food shortage periods, consumers attempt to meet their calorie requirements quantitatively, whereas during times of surplus they seek better quality and more diversified foods.

The establishment of standards and grades for a product is one of the systems used to guide farmers in adjusting themselves towards recommended grain classification. However, the existing standards and grades are applicable only to government procurement schemes. They are quite unknown in the public market-place.

The criteria for standards and grades of cereal products vary between countries. In Indonesia, establishment of grain standards is not officially regulated by law, and this restricts their widespread application. Similarly, the equipment used to measure quality parameters is not subject to enforceable standards. This leaves the market open to manufacturers of equipment whose sole aim is to maximise profit. For instance, in nearly all developing countries that produce cereals there are various brands of moisture meter that show differences in measurement performance. Although the moisture meter has been standardised, new types of moisture testers continue to flow into the country to replace the existing moisture meter that is extensively used in the field. The same is true for

equipment used for measuring other aspects of quality.

For postharvest equipment that is imported, government determines its standard and calibration before it is used at the farm level or in private business. This has had a positive effect on the development of the postharvest industry domestically, especially as regards efforts to obtain equipment suited to local conditions.

A prime component of efforts to stimulate improvements in postharvest handling is the provision of support to plant breeders to develop grain varieties that possess resistance to the factors which cause postharvest deterioration. Varieties with such characteristics will reduce the costs of postharvest handling. The experience of the farmer who uses various kinds of HYVs is not always positive, because these new varieties, in spite of their higher productivity, suffer from lower quality.

In buying paddy from the farmer, the government usually gives the highest price to those farmers who are able to produce better quality of paddy/rice. In Indonesia, the floor price of paddy in 1986 was determined according to its moisture content (m.c.) as follows:

Dry paddy at field level: Rp. 110³/kg, m.c. approx. 20%

Dry paddy at village level: Rp. 135/kg, m.c. approx. 18%

Dry paddy at barn level: Rp. 150/kg, m.c. approx. 16%

Dry paddy at mill level: Rp. 175/kg, m.c. approx. 14%

These prices are paid by the KUD⁴ to farmers. The KUD has to process this paddy before it is delivered to BULOG at a price of Rp. 187/kg. If the KUD is able to satisfy quality requirements determined by the government, BULOG will pay an extra premium of Rp.5/kg. Therefore, the purchase price by BULOG from the KUD is in fact Rp. 192/kg. It is clear that the floor and purchase prices for paddy set by BULOG include incentives to improvement of paddy quality. There is expected to be an extensive farmer response to these incentives.

In the Philippines (NAPHIRE 1986), the government, through the National Food Authority, pays a premium for each kilogram paddy as follows:

- (i) a quality incentive for paddy with KA 14% and a pureness of minimum 85% is paid, amounting to Peso⁵ 0.02 up to Peso 0.05/kg.

³During September 1986, 1700 Indonesian rupiah (Rp.) = US\$1.

⁴KUD = village level cooperative.

⁵During September 1986, 20 Philippines pesos = US\$1.

- (ii) an incentive for the cooperative as high as Peso 0.03/kg.
- (iii) a price incentive for the members of a farm group as much as Peso 0.03/kg with the expectation that the farmer will become a member of the group.

Since 1979 the total amount of incentive is kept by government and then used as an investment to build postharvest facilities.

The Government of Indonesia realises the importance of institutional aspects at the farm level to promote the avoidance of postharvest losses and improvement of product quality. The establishment of the KUD in Indonesia since 1973 is also aimed at motivating farmers to adopt better handling practices for food products. This is emphasised in Presidential Decree No. 11/1981, where the KUD as paddy purchaser at the village level must own various kinds of postharvest facilities. BULOG is one of the government institutions assigned since 1981 to furnish the KUD with various postharvest facilities.

As well as the KUD, farmers come together to form farm groups. These are informal institutions that foster communication between farmers. Various farmer groups jointly take the initiative to buy postharvest equipment for the interests of their group. Because of their shared interests, such groups can exchange experiences in food handling. Indonesia's national postharvest institution is at an early stage of development. Based on the Decree of the Minister of Agriculture in 1981, the National Post Harvest Committee was formed. It is directly managed by the Directorate General of Food Crops, with membership representing various government offices. This institution has limited funds and personnel, so its functions at present are restricted to coordination and monitoring of various postharvest activities carried out by various groups in Indonesia. It may be succeeded by an authority with greater powers.

In Indonesia, BULOG is one of the government offices at a national level responsible for the marketing of grain and improvement of postharvest handling. In Malaysia, LPN (Lembaga Padi dan Beras Negara, National Paddy and Rice Authority) has a task similar to BULOG, but covering the rice industry. In the Philippines, the National Post Harvest Institute for Research and Extension (NAPHIRE), a subsidiary of the National Food Authority, handles postharvest research and extension. In Japan, postharvest matters are handled by the Department of Food and Fisheries and in Thailand by the Department of Agriculture.

The government offices mentioned above all have the same task of raising farm incomes through the

introduction of proper techniques in the food crops sector.

Supervisional Aspects

Government has the obligation to supervise farmers, individually or collectively, in order to overcome various postharvest problems. Government extension workers should be able to establish and maintain direct and continuous communication with farmers. The extension programs organised by government are not limited to training courses. Demonstrations and field visits are more important. Through extension programs, various developments in postharvest handling are communicated, including the introduction of equipment suitable for small farmers. In this matter, the presence of experts from various international agencies has been particularly useful. These experts have usually lived with farmers and have trained the key local farmers and farm groups. The implementation of such programs usually makes use of the existing institutions in the villages, such as the KUDs. The problem still faced in this approach is that there are not enough competent training personnel. It often occurs that a trainer is able only to clarify the importance of postharvest efforts but does not have sufficient skill to demonstrate practical solutions to specific difficulties.

Since the mid 1970s, Indonesia has made use of the KUDs as a communication channel for farmer training. The government has made special efforts to support these institutions by providing them with small-scale processing and storage facilities. Each of their storehouses is provided with a drying floor used by the members of the cooperative without cost. In addition, the KUDs are also provided with mechanical dryers to dry paddy newly purchased from farmers. For this purpose the KUDs are provided with credit at subsidised interest rates.

Research and Development Aspects

Pre- and post-harvest problems must be approached in an integrated way. Much research to find new varieties of paddy resistant to pests and diseases, and to improve the planting system and plant care is under way. In general, the government is directing postharvest research towards achievement of three objectives:

- a better postharvest handling system
- development/modification of postharvest equipment.
- monitoring and regular evaluation of progress.

A chronic problem faced by farmers is lack of technical knowhow regarding the causes of quantitative and qualitative losses. Farmers do not pay sufficient attention to these problems because they badly need cash. This forces them to sell their

paddy to commercial buyers in advance of the harvest. Such a situation is disadvantageous to farmers since most will further reduce their farm income. In turn, they will be unable to turn their experience towards better practices.

Research into postharvest handling systems aims to understand the constraints faced by farmers in postharvest activities. Various studies have concluded that the main technical problem faced by farmers is ignorance of the external factors affecting grain quality. In tropical areas, most farmers rely on the sun for grain drying. Even if they have mechanical dryers, they limit their use because of their higher costs and a lack of adequate operating skills.

The development and modification of equipment to make it suitable for local farmer use is continuously supported by the government. These activities are clearly required to respond to changes in the production sector. For example, the introduction of superior varieties led to a change in certain postharvest equipment. Modification or adjustment of equipment is not always as rapid as

the changes in varieties so that the maximum results cannot always be achieved immediately.

In addition, possible utilisation of food crop by-products for other purposes needs intensive research. The use of paddy husks to fuel drying equipment is still limited despite a number of studies in other countries concluding that these materials have a high value in drying technology.

Technological Change

There have been no specific studies on the impact of government activities on technological change in the postharvest sector. This is understandable because postharvest policy is part of the overall agricultural policy. In other words, when technological changes appear in the postharvest sector, it is difficult to determine whether they are the result of production policy, extension, or an increase in skill of the farmer.

Government involvement is a consequence of pricing policies that obligate it to purchase paddy from the farmer, and store, preserve, and distribute it to the public. In each activity there is a string of postharvest problems, as depicted in Figure 1.

Grain enters government marketing schemes at procurement. Purchasing is carried out at the floor price level subject to quality specifications. The two parties involved have different interests. The farmer wants to sell his product immediately at any quality, while on the other hand, government applies tight quality selection to obtain better quality grain that can be safely stored for one to two years. In this regard moisture content causes the greatest problems. Most paddy and rice rejected by the government during procurement contains excessive moisture. In general, paddy marketed by farmers has moisture contents ranging from 16 to 18%, while the government has set a maximum of 14%. About 26% of the rice handed over by the farmers via the KUDs to BULOG in 1985 was rejected, about half the total rejections being due to excessive moisture (Table 5).⁶

Table 6 also shows some progress in improving paddy quality in 1986, as indicated by an increasingly smaller percentage of paddy being rejected. The level of paddy rejection due to higher moisture content has decreased from 50 to 15% and rice from 49 to 11%.

However, an increase in yellow grains over the previous year and lower milling yield in 1986 is also observed. In 1985, about 45-50% of rice was turned down due to the failure of the KUDs to meet milling requirements. The problem of yellow and damaged

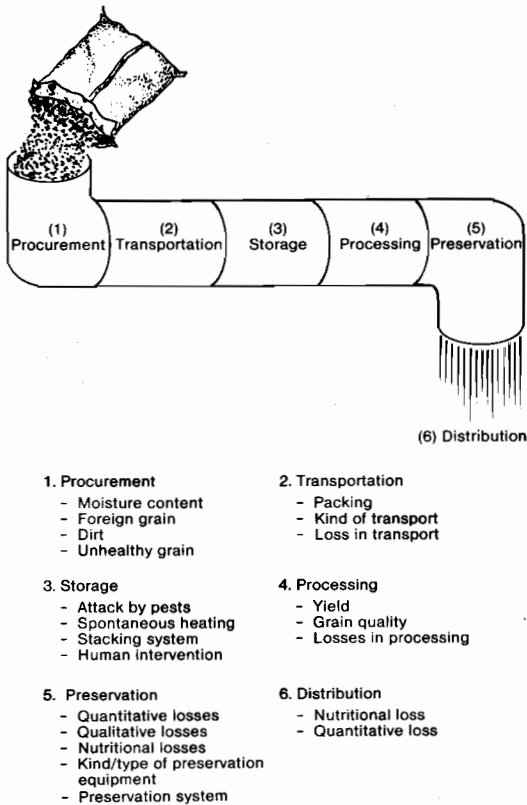

Fig. 1. Problems likely to be encountered at each stage of the food pipeline from procurement to distribution.

⁶ Clarification by BULOG to Republic of Indonesia Parliamentary Hearing, July 1985.

TABLE 5. Factors causing the rejection by BULOG (Indonesia) of paddy and rice purchased from KUDs and farmers in 1985 and 1986.

Quality component causing rejection	March-April	March-June
	1985 (%)	1986* (%)
I. Paddy		
— Moisture content	50	15
— Yellow grains	30-40	46.9
— Empty/foreign matter	20-32	29
II. Rice		
— Moisture content	47	11
— Milling degree	45-50	62
— Bran	8-25	9
— Broken rice	7-28	12
— Damaged grains		
— Yellow grains	25	5

Source: BULOG.

* Values relate particularly to East Java where domestic procurement weight is about 50% of the total.

grains in 1985 appeared to be the greatest obstacle experienced by farmers in selling rice to BULOG. Discoloration of grain resulted from improper drying after harvest. This led government to speed up the introduction of threshers and drying floors at the beginning of 1986, along with rice milling unit rehabilitation.

The incidence of high moisture content, impurities, and admixture of foreign matter at the time of processing is a common problem faced by farmers in Asia (Frio 1981). Improper treatment is not the only cause of yellow grain. It is also due to unawareness of farmers about the importance of better drying techniques. In Indonesia, around 70% of paddy is harvested between February and May, during which time labour force utilisation in the food crops sector reaches its peak. There is therefore intense competition for labour at the farm level. As a consequence, newly harvested paddy cannot be threshed and dried immediately and may be piled up and left in the field for more than a week. During this time, chemical changes take place which cause browning. Even if the farmer can immediately thresh and dry his paddy, this is for the most part done using traditional techniques. The Agricultural Census of 1983 in Indonesia summarised the levels of usage of various drying techniques at farm level as shown in Table 6.

The percentage of households using the ground for drying is apparently higher outside (94-97%) than in Java (75-82%). The occurrence of chalky and immature grain is not caused solely by imperfect reaping techniques but is also associated with various physical characteristics of the HYVs.

Since the early 1970s Indonesia has released about three new types of HYVs every 2 years.⁷ The HYVs

TABLE 6. Methods used to dry paddy in Indonesia, 1982-83.

Method of drying	Percentage of farm households using method
On the ground without sheet	6.31
On the ground with sheet	82.71
On a cement floor	8.05
Drying machine	0.03
Other	2.90

Source: Eryatno et al. (1986). Further information on the subject is provided in Frio (1981).

require more intensive handling due to their low resistance to pests and diseases. In addition, they have shorter stems than the local varieties. Consequently, farmers have to adjust their reaping technique from using a small knife (ani-ani) to the use of sickles. The 1983 Agricultural Census yielded information on the numbers of farm households using various types of tools to harvest their paddy. This is summarised in Table 7.

The information in Table 7 contrasts with that from the 1960s when 70-80% of farmers in Java used the small knife (ani-ani) to cut their paddy. The use of the sickle raised some problems in sorting out mature and immature grains.

In Indonesia, the development of rice processing industries began before independence. Water mill processing machines used then have since been replaced by mechanical mills. Those types of mills using a stone wheel (Engelberg) have also been modernised gradually with the latest type of mills using rubber and abrasive rollers. Government influences rapid modernisation through the application of tight quality specifications for the rice it buys. In fact, this influences not only the utilisation of modern milling equipment but also the pre-milling treatment of paddy. To be able to produce good quality rice and high milling yields, attention to the purity of the paddy before milling is needed. Engelberg-type mills result in relatively high losses because of their lower milling recovery and the high percentage of broken.

During the Repelita IV (1983-88), the Government of Indonesia is easing loans from the government bank to private millers, particularly to KUDs who would like to convert their older mills into modern ones. In addition, government is also attempting to draw external assistance from various international agencies to carry out research, supervision, and modification of equipment to make it suitable for the socioeconomic situation of

⁷ By 1982-83 approximately 50% of the paddy fields in Indonesia were being planted with HYV, starting with IR 5/8 and most recently with IR4₂.

local farmers. In the Indonesian province of Aceh from 1980 to 1983 various efforts were made jointly by the Government of Indonesia and FAO to change the attitudes of farmers who had been known to suffer yellow grain contents up to 60%. Before the project, farmers in this area failed to improve their incomes since the price they received for their rice was lower than that of farmers who were able to produce better quality of rice. The positive influence of continuous supervision and demonstration brought about a gradual reduction in the amount of yellow grain, as shown in Table 8.

The reduction in yellow grain content over the last six years is considered to be the result of the dramatic technological change in grain postharvest and marketing that has taken place in Aceh. The influence of this technological change has presented a good opportunity to the local farmers to get added value for their products. The local Dolog has also made it possible to buy and store local rice in thousand tonne lots for local reserves and to supply neighbouring areas. Realising this, the government has attempted to expand such methods to all regions and to encourage farmers not to leave their paddy in the field after harvest. This campaign was supplemented by the provision of facilities to the farmers, the KUD, and businessmen to enable them to obtain postharvest equipment such as threshers, mechanical dryers, and modern rice milling units. The availability of spare parts and workshops for postharvest equipment, as well as the existence of information and mobile repair units at the farm level have also helped to improve postharvest activities.

It is also worthwhile noting that the government has given priority to facilitating the provision of modern equipment to the KUDs, by giving them access to credit from the government bank at a reduced interest rate.

Table 9 shows the various kinds of postharvest equipment that had been provided to the KUD by 1984.

Government intervention in the rice trading system not only assists the village economy as a whole, but also changes the perceptions of farmers and traders of storage patterns. The change in

TABLE 7. Numbers of households in Indonesia using various types of paddy harvesting tools, 1982-83.

Type of tool	Households using tool	
	Number	Percentage
Small knife (ani-ani)	2 367 938	23.64
Sickle	7 036 443	70.25
Other	259 425	2.59
No response	351 962	3.51
Total	10 016 068	100.00

storage pattern has been affected to varying extents by the following factors:

1. The relatively small price differences between harvest and other times so that the farmers feel 'secure' of the rice supply. This is also caused by the wide introduction of HYVs which can increase yields by at least 4-5 times within 2 years. This results in a continuous availability of food throughout the year.

2. The rapid introduction of small scale rice milling units to the villages to replace the older, conventional mills. As a result, paddy now stays in the village for a much shorter period than it did in the 1960s. If, during the 1960s, the interval between paddy and milled rice was 10 to 14 days, it is now only 3 days. This is one of the reasons why rice market operations to serve urban consumers entered the village markets. Improvements have brought about rapid transfer of household food stocks from villages to the market for commercial purposes.

3. Modernisation and establishment of the government warehouses, which are currently located in the villages, also engenders a feeling of food security and overcomes the tendency to store large stocks for long periods in family houses.

4. The extension program carried out by the government has changed the attitude of farmers and

TABLE 8. Reduction in the incidence (%) of yellow grain in Aceh province, Indonesia over the period 1979-80 to 1984-85.

Region	79/80	80/81	81/82	82/83	83/84	84/85
Aceh Besar	23	24	25	7	3	7
Pidi	20	23	30	8	5	6
North Aceh	22	21	27	9	3	6
West and South Aceh	18	20	22	7	4	9
East Aceh	21	19	22	6	3	6
South East Aceh	16	14	11	5	2	5

Source: Alfatah (1984).

TABLE 9. Postharvest facilities owned by the KUD (Indonesian village level cooperatives) in 1984.

Type of equipment	No. of units	Capacity per unit	Total capacity
Storage	4222	—	714 203 t
Kiosk	6747	—	162 786 t
Drying floor	3180	—	1 473 508 m ²
Huller	890	636 kg/hr	—
Polisher	859	562 kg/hr	—
Rice milling unit	404	1 t/hr	—
Rice milling unit	1061	0.5 t/hr	—
Thresher	229	108 kg/hr	—
Dryer	479	1 t/hr	—
Moisture tester	3381	—	—

Source: Anon. (1985).

businessmen to storage systems. At the beginning of the 1970s, old warehouses in poor condition were still used to store food commodities. Since the end of that decade, those warehouses have had to be rehabilitated by their owners if they want to continue to deal with BULOG. Warehouses which are not technically suited to storing human food have now been returned to the owners.

Traditionally, rice is stored by farmers, traders, private millers, KUD, and the government (see Fig. 2). The relative amounts stored by each group are very much influenced by various factors, including price speculation and forecasts for the next harvest. Studies conducted by BULOG in 1980 regarding the marketable surplus estimated that the average increase of paddy marketable surplus has increased from 25–30% in the 1960s to 60–70% now. This suggests that paddy storage centres have moved away from the villages, and that there is likely to be a decrease in farmer involvement in postharvest handling.

The study also revealed a continuing disappearance of village rice barns, which had in the

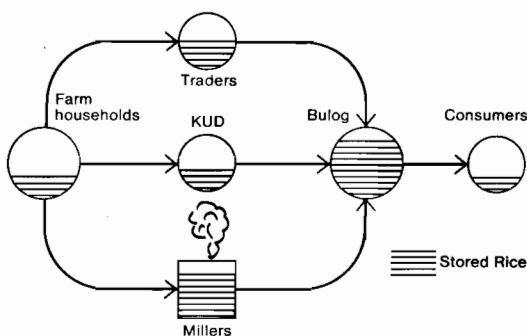

Fig. 2. Points of storage in the Indonesian rice economy.

past functioned as a collective food reserve for villagers. In order to maintain rice reserves at the village level, the government provides each KUD with a small warehouse to store paddy or rice for the village.

On a larger scale, the government is also charged with storing rice in substantial amounts provided for budget groups and market price stabilisation. Between 1969–70 and 1984–85 the amount of stock handled by the government for these purposes is shown in Table 10. It is apparent from this table that the total rice stocks held by BULOG continue to increase from year to year, in parallel with increases in domestic procurement. This reflects more intensive attention to stock control and management to prevent deterioration of the grain. This consists of:

- standard warehouse design suited to local conditions;
- improvement of technical procedures for conservation of stocks during the storage period;
- regular monitoring of paddy/rice quality to assess its storability.

Due to an increase of rice held in storage, BULOG initiated construction of new storage facilities in 1976. These have now reached a total capacity of about 2.5 million tonnes and are expected to reach 5 million tonnes, sufficient to store various food stuffs. Whereas in the mid 1970s rice in BULOG warehouses suffered from losses of 3–4% per year, these have now been dramatically reduced to 0–0.3%. The remaining problem awaiting solution is the decrease in rice quality during storage which considerably lowers its monetary value. Very recently, BULOG has attempted to apply various techniques of rice preservation, such as the use of

TABLE 10. Quantities of rice ('000 tonnes) handled by BULOG, 1969–70 to 1984–85.

	PEL. I	PEL. II	PEL. III					PEL. IV	
	Average per year	Average per year	79–80	80–81	81–82	82–83	83–84	Yearly	84–85
Initial stocks	317	555	709	843	1.242	1.591	1.013	1.080	1.417
Domestic procurements	349	554	431	1.635	1.934	1.933	1.189	1.426	2.378
Imports	913	1.389	2.606	1.229	437	506	1.115	1.180	185
Subtotal	1.262	1.945	3.007	2.864	2.371	2.439	2.304	2.606	2.763
Grand total	1.579	2.498	3.746	3.707	3.613	4.030	3.317	3.663	4.180
<i>Distribution</i>									
Budget group	790	749	796	697	860	1.425	1.462	1.054	1.452
Market operation	364	984	2.036	1.628	1.033	1.517	399	1.327	70
Others	55	96	42	144	80	30	11	58	133
Total	1.209	1.819	2.874	2.439	1.973	2.972	1.872	2.429	1.655
Losses	42	51	29	26	49	45	28	35	25
Ending stock	328	628	843	1.242	1.591	1.013	1.417	1.199	2.500

Source: BULOG.

carbon dioxide in large and small plastic bags, regular tests of rice storability on a weekly basis, the use of ventilated stacks, and vacuum containers with a total capacity of 200 000 tonnes per year.

As perhaps a last resort in halting deterioration of rice in storage, immediate sales are also initiated at relatively lower prices. Although this solution violates first-in: first-out rules, it is still preferable to the losses incurred if rice is kept longer in warehouses.

In 1985, the government began to apply strict quality standards during procurement periods (see Appendices 1 and 2). One of the objectives of this policy is to stimulate farmers and traders to improve their technical skills in rice processing before selling their crops to BULOG. The role of the government in storage extends the whole length of the postharvest chain. The introduction of a good storage system will be futile if this is not followed by the willingness to adopt better drying, sorting, and sanitation techniques. It is generally known that in the areas with high relative humidity and temperature, the multiplication of insects is very fast. It is estimated that a population of 50 insects existing at the time of harvest can multiply to over 300 million after 4 months. Pests also like foods that have a high nutritional content. That is why farmers

Appendix I

Paddy quality standards in Indonesia, 1972-73 to 1985-86.

Year	Water content	Empty grains	Chalky grains	Red grains	Yellow grains	Damaged grains
1972-73	14	4	—	—	—	—
1973-74	14	4	—	—	—	—
1974-75	14	3	3	—	—	3
1975-76	14	3	3	3	3	—
1976-77	14	3	3	3	3	—
1977-78	14	3	3	3	3	—
1978-79	14	3	5	3	3	—
1979-80	14	3	5	3	3	—
1980-81	14	3	5	3	3	—
1981-82	14	3	5	3	3	—
1982-83	14	3	5	3	3	—
1983-84	14	3	7	3	3	—
1984-85	14	3	5	3	3	—
1985-86	14	3	5	3	2	1

Source: BULOG.

Quality requirements

1. Free from pests and disease.
2. Free from rotting, acid or other odours.
3. Free from existence of dangerous chemicals, visually as well as organoleptically.

Note: The yellow and damaged grain components are combined from 1975-1976 until 1984-1985, inclusive.

Appendix II

Milled rice quality standards in Indonesia, 1969-70 to 1985-86.

Year	Quality	Milling grade	Water content	Broken grains	Small broken grains (menir)	Gravel	Chalky grains	Paddy grains	Red grains	Damaged grains	Yellow grains	Foreign matter
1969-70	B	1/1	14	35	2	10	—	25	—	—	1/2	20
1970-71	B	1/1	14	33	2	10	—	25	—	—	1/2	20
1971-72	B	1/1	14	30	2	10	—	25	—	—	1/2	20
1972-73	B	1/1	14	25	1	—	3	3	3	2	3	10
1973-74	B	1/1	14	35	1	—	3	30	3	2	1	10
1974-75	B	90	14	35	2	—	3	30	3	—	3	10
1975-76	B	90	14	35	2	—	3	30	3	—	3	10
1976-77	B	90	14	35	2	—	3	30	3	—	3	10
1977-78	B	90	14	35	2	—	3	30	3	—	3	10
1978-79	B	90	14	35	2	—	3	30	3	—	3	10
1979-80	B	90	14	35	2	—	3	30	3	—	3	10
1980-81	B	90	14	35	2	—	3	30	3	—	3	10
1981-82	B	90	14	35	2	—	3	30	3	—	3	10
1982-83	B	90	14	35	2	—	3	30	3	—	3	10
1983-84	B	90	14	35	2	—	3	2	3	—	3	1
1984-85	B	90	14	35	2	—	3	2	—	—	3	1
1985-86	B	90	14	35	2	—	3	2	—	—	3	1

Source: BULOG

Quality requirements

1. Free from pests and diseases
2. Free from musty, acid, or other odours
3. Free from bran and grit
4. Free from existence of dangerous chemicals, visually as well as organoleptically.

Note: The yellow and damaged grain components are combined from 1974-1975 until 1984-85, inclusive.

are reluctant to store grains like soybeans for long periods, because they will immediately be infested by insects.

In this regard, the government recommends the use of the most effective insecticides, based on tests in research laboratories. Resistance tests involving those insecticides are an important aspect and periodic evaluation of each of the chemicals is mandatory. Unawareness of pest resistance to the existing chemicals results in even greater monetary losses.

Research and development in the postharvest field currently attracts serious attention. The government gives top priority to this field because it has realised its general importance to most people. Detailed research regarding the effects of government activities on the technological changes occurring in the postharvest sector is still relatively scarce in Asia. Nevertheless there are a number of studies that have been widely published, although most are limited to technical aspects of postharvest activities and very few consider the role of the government.

Close cooperation, such as joint research and exchange of field experience among postharvest institutes in the Asian region, needs to be strengthened in the coming years.

References

Alfatah 1984. Rice farming problems in Aceh. Presented at FAO regional workshop on drying and handling of wet paddy. Philippines, 1984.

Anon. 1976. Survey of post-harvest practices in Thailand. Bangkok, Department of Agriculture and Cooperatives and IDRC.

1982. Study report on post-harvest losses in the Republic of Indonesia. Jakarta, Department of Agriculture and Japan International Cooperation Agency.

1985. The rice post-harvest system in Indonesia. Directorate General of Food Crops, Department of Agriculture, Regional Workshop on Rice Processing Industry. July 1985, Jakarta.

Boxall, R., and Greeley, M. 1978. Indian storage project. Presented at Seminar on post-harvest grain losses, Tropical Products Institute, 1978, London.

de Padua, D.B. 1974. Post-harvest rice technology in Indonesia, Malaysia, the Philippines, and Thailand. A

state of the art survey. Ottawa, International Development Research Centre.

Eryatno et al. 1986. Agricultural census 1983, post-harvest management and marketing. Jakarta, BPS.

Fang Zhiying 1985. Rice grading, marketing and pricing policy in China. In: Proceedings of FAO regional workshop on rice grading, inspection and analysis. March 1985, Lahore, Pakistan, 57.

FAO 1985. Food outlook 1984, statistical supplement. Rome, FAO.

Frio, A.S. ed. 1981. Socio-economic aspects of post-harvest operations in farmers' groups. Proceedings of 1981 exchange program. April, 1981, Jakarta.

Hall, D.W. 1971. Handling and storage of food grain in tropical and subtropical areas. FAO Agricultural Development, 20.

Hashifah, M., and Rohani, M. Yon. 1985. Paddy and rice grading systems in Malaysia. In: Proceedings of FAO regional workshop on rice grading, inspection and analysis. March 1985, Lahore, Pakistan, 147.

Kruavan Attaviriyasook 1985. Quality analysis and grading system of Thai rice. In: Proceedings of FAO regional workshop on rice grading, inspection and analysis. March, 1985, Lahore, Pakistan, 131.

M. Abdul Malik 1985. Quality assessment of exportable varieties of rice procurement procedures in Pakistan. In: Proceedings of FAO regional workshop of rice grading, inspection and analysis. March 1985, Lahore, Pakistan, 43.

NAPHIRE 1986. Impact of grain marketing and pricing policies in the postharvest system. Manila, National Post-Harvest Institute for Research and Extension, April 1986.

Prabhat Chandra Pandey 1985. Paddy/rice sampling, grading and analysis methods adopted in Nepal. In: Proceedings of FAO regional workshop on rice grading, inspection and analysis. March 1985, Lahore, Pakistan, 94.

U.S. National Academy of Sciences 1978. Post-harvest food losses in developing countries. Washington, D.C., National Academy of Sciences.

U Than Tun 1985. Paddy/rice grades and standards in Burma. In: Proceedings of FAO regional workshop on rice grading, inspection and analysis. March 1985, Lahore, Pakistan, 49.

Yoshitsuyu Umeno 1985. Inspection system, procurement procedures and the relation between inspection, grades and procurement prices in Japan. In: Proceedings of FAO regional workshop on rice grading, inspection and analysis. March 1985, Lahore, Pakistan, 75.

Institutional Changes Session Chairman's Summary

J. V. Remenyi *

THE postharvest problem arises in an environment that reflects important changes in some critical parameters. Three of these that are central are:

- the increased importance of the wet season crop in total output;
- the shift to increased commercialisation in cereal markets in tropical countries, reflected by a higher proportion and quantity of output entering the marketing chain;
- growth in sophistication and capacity to discriminate between qualities of grains as incomes and food security increase in tropical countries.

Institutional innovation and adaptation will be essential and inevitable as the impact of these parameter changes gains momentum.

However, this does not imply a need to succumb to haste. Heretofore, there has been a tendency to create waste through excessive haste in so far as parastatal institutions were created where such innovation has not contributed to increased efficiency. The power of the invisible hand of the free enterprise system to address, and produce, appropriate solutions to postharvest problems ought not to be underestimated. Similarly, the observed impotence and problems associated with government intervention in the free market postharvest environment should not be understated. The tendency in the past has been to fall into both of these traps, with the result that governments have overstated the case for intervention, understated the need to get policies right, and promised growers and consumers more than governments have been able to deliver.

Institutional change in the postharvest system should not and can not be avoided. However, this does not recommend complacency or neglect of institutional issues. Rather, it suggests the need to recognise certain factors:

1. The value added by postharvest processes is relatively small. Hence, it is important to quantify where in the chain of activities that make up the postharvest system, losses — both physical and economic — arise. Where do inefficiencies arise? Can we do something about these cost-effectively?

2. Urbanisation will become an increasingly important determinant of demands being made on the postharvest system. To come to grips with these we need information on the evolving marketing system plus trends in consumer preferences. This implies the need for more attention to trends in marketing margins, infrastructure constraints, and price policies affecting gains in the tropics. Only by doing the empirical market research can we ascertain what people/consumers are prepared to pay for in terms of change in grain quality.

3. The postharvest problem at farm level increases in importance with the degree of labour shortage at harvest time. Hitherto, this has been known as essentially the Malaysian problem, but there are signs that peak labour demand problems are becoming more prominent in Indonesia and elsewhere.

* ACIAR, G.P.O. Box 1571, Canberra, A.C.T. 2601, Australia.

4. No single discipline has a monopoly on solutions to postharvest grains problems in the tropics. In the past, there has been a tendency to stress engineering solutions, with the result that inappropriate technologies have arisen and been promoted at various times in different countries. Inadequate attention has been given to the contribution that members of other disciplines — especially policy-oriented social scientists and cereal breeders — can make to more efficient operations in postharvest activities.

5. Market failures in the postharvest chain can be identified. However, optimal solutions to these failures do not always imply a parastatal or similar public intervention. Governments can facilitate group action or the relaxation of the constraints that give rise to market failure by ensuring that necessary infrastructure is put in place and that policies in force result in the correct set of incentives to farmers, processors, transporters, and other actors in the postharvest sector. Where market failure arises because of a lack of information or the existence of uncertainty and risk, the public sector can assist by identifying these gaps, anticipating the needs of users of the information, and assisting the generation of information flows to fill these gaps. It should be stressed, however, that the mere identification of these market failures does not imply the need for yet another parastatal or government department.

The picture painted in the foregoing discussion has a number of implications:

- There is a need for much more policy work in the food sector.
- Postharvest losses need to be quantified and their sources identified.
- There is a need to isolate where inefficiencies arise in the postharvest chain and design solutions to overcome these.
- There is a need for lateral thinking to ensure that the appropriate discipline is brought to bear on problems identified.
- The costs of inappropriate policies and institutional responses need to be identified, in order to underscore the case for reform.

Rates of Technological Change

Adoption and Diffusion of Technology: an Overview

R.K. Lindner *

Abstract

There is a vast literature on innovation adoption and diffusion, and no attempt is made in the paper to provide an exhaustive review of this. Instead, a simple conceptual framework of the innovation adoption process based on recent research in this area is developed. The model is then used to classify and critically assess the different types of adoption and diffusion studies, many of which contain apparently conflicting results. However, a much clearer picture of the constraints to adoption and of the determinants of rate of innovation diffusion emerges from a selective review of the empirical literature using the conceptual model to filter out misleading findings. The primary consideration is that the technology be appropriate to the potential adopter, in the sense that adopting the innovation is in his/her best self-interest. If this critical precondition is not met, then any initial adoption will be ephemeral. On the other hand, given fulfilment of this condition, there are some prospects for speeding up the rate of diffusion by attention to factors such as innovation testability, and to communication channels for information about innovation productivity.

THE study of technological change is important for a number of reasons, including notably the pivotal role that it plays in the process of economic growth. Technological change involves two subprocesses. The first is the generation of new technologies. The second is the adoption of such technologies by producers, etc. Although innovation development is a necessary condition for adoption, the potential benefits from development of new technologies can only be realised once they are adopted. Furthermore, the rate of return to society on the development of new technologies depends, among other things, on how quickly such benefits are realised. Hence, the rate at which adoption of innovations diffuses through the population of potential adopters is an important determinant of economic growth.

This paper focuses on the phenomena of adoption and diffusion of new production techniques (sometimes called *process* innovations). The term adoption will be used to denote the process whereby an individual producer decides whether or not to use the new production technique, while the term diffusion will be reserved to describe the cumulative

spread of such adoption decisions over time and through space.

The literature on innovation adoption and diffusion is vast and growing. An insight into the explosion of research on this topic is provided by Rogers and Shoemaker (1971). In the preface to their book entitled 'Communication of Innovations — A Cross-Cultural Approach', they note that Rogers (1962) was able to base the previous edition on only 405 reports, which were kept in a cardboard box. By the time of the second edition eight years later, the number of publications had trebled, and the authors found that they needed to develop a computerised database to keep track of all the publications. Since 1971, the literature has continued to grow, and no one now claims to be aware of all publications on the topic, let alone to have read them all.

Worse still, any attempt to present a comprehensive review of this literature here would not be enlightening. On almost any issue relating to information adoption and diffusion, it is possible to find studies which reach contradictory conclusions. There are a number of reasons for this unsatisfactory state of affairs, some of which will be discussed in the selective review of empirical studies in the third section of this paper. The different types of research are put into perspective

* School of Agriculture, University of Western Australia, Nedlands, Western Australia, 6009.

there, so that readers will be better able to judge the relative merits of individual publications. Before doing so, a model of the innovation adoption process is described in the next section. The conceptual framework so developed is quite simple and serves as a useful reference point for the subsequent literature review. Like any attempt to simplify, however, it has its limitations. In the fourth section of the paper, some of the deceptively simple concepts are discussed in more detail to provide some appreciation of the diversity encountered in the adoption and diffusion of actual innovations.

The Modern Theory of Innovation Adoption and Diffusion

Adoption is essentially a simple process despite the diversity in type of innovations, characteristics of potential adopters, patterns of innovation diffusion, and time taken by different individuals to decide to adopt/reject any particular innovation. Basically it involves just two universal components, namely risky choice and the acquisition of knowledge (i.e., learning).

At any point in time when a potential adopter has to decide whether to adopt or not, he/she will be uncertain about the consequences of this choice. The choice is risky in the sense that uncertainty exists about whether the decision-maker will be made better off or worse off by adopting the innovation. Some of the complexities involved in the concept of 'best self-interest' (or 'own welfare' or being 'better off') are discussed later. For the time being, it is sufficient for the decision-makers' best self-interest to be defined by the action each would choose if they had complete, but not necessarily perfect, knowledge.

Since the choice of technique decision is contingent on the uncertain state of knowledge, it must be based on subjective beliefs incorporating currently available information. Even though the decision-maker might be uncertain about the outcome of several uncertain future events which impinge on this decision, basically there are only two possibilities (or STATES of the 'world'):

STATE I: The innovation is *in fact* 'GOOD' for the potential adopter in the sense that it would be adopted given complete knowledge.

STATE II: The innovation is *in fact* 'BAD' for the potential adopter in the sense that it would be rejected given complete knowledge.

For this simple situation, it is possible to classify decisions into one of only four possible categories illustrated in Figure 1. The possibility that the decision-maker will make an *incorrect* decision is

represented by cases 2 and 3 in Figure 1. Using the terminology of statistical hypothesis testing, these two cases of incorrect (wrong) adoption and incorrect (wrong) rejection involve type 2 and type 1 errors, respectively, if the null hypothesis is that the innovation is 'good'. Clearly, cases 1 and 4, which represent correct adoption and correct rejection, respectively, involve no error on the part of the decision-maker.

The likelihood of making a correct, or incorrect, decision clearly depends on the decision-maker's knowledge of the relevant parameters. In particular, the greater the potential adopter's level of knowledge about the performance characteristics of the innovation, the less likely it is that an incorrect choice of adoption decision will be made. However, as noted above, adoption is above all else a dynamic learning process. Analytically, this learning process can be treated as comprising two further sub-processes: the first is the acquisition of information; the second is the incorporation of this information into the potential adopter's PRIOR beliefs to form revised, or POSTERIOR beliefs about innovation performance. Because these beliefs are likely to change over time as the potential adopter acquires more information about how the innovation can contribute to his own welfare, the choice of technique decision is likely to be reviewed periodically. Hence, an individual may well change a previous adoption decision, and thus move from one to another of the classifications in Figure 1. In particular, a subsequent adoption by the majority of potential adopters who initially reject an innovation represents a movement from case 3 to case 4 in Figure 1, thereby eliminating type 1 error. By the same token, some adopters of an innovation might subsequently decide that their first choice was a mistake, and reverse this decision. This subsequent rejection is depicted in Figure 1 by a reclassification from case 2 to case 1, thus eliminating type 2 error.

To summarise, the adoption process can be characterised as a sequence of risky choices. Initially, the potential adopter knows less about the innovation than about the alternative technology,

		States - actual value of the innovation (i.e., with complete knowledge)	
		Innovation good	Innovation bad
Subjective beliefs (i.e., with incomplete knowledge)	Adoption (increases welfare)	Case I Adoption correct (no error)	Case II Adoption incorrect (type 2 error*)
	Rejection (increases welfare)	Case III Rejection incorrect (type 1 error*)	Case IV Rejection correct (no error)

Fig. 1. A classification of four possible types of innovation usage decision given incomplete knowledge.

but this information asymmetry is progressively eliminated. Immediate adopters learn from trial use of the innovation, while immediate rejecters are forced to learn by observation. The adoption process terminates when the potential adopter is equally well, or poorly, informed both about the traditional technique and the innovation, and on this basis makes a final choice between adoption and rejection.

Equivalently, diffusion of an innovation amongst a population of potential adopters essentially involves a transition over time and space from a situation of incomplete knowledge to one of complete knowledge. Many individuals, through ignorance, initially make adoption decisions which are not in their own best interest, but progressively such errors are corrected through the accumulation of knowledge. The diffusion process is complete when all those who could benefit from adoption have done so, and when all those who would not benefit from it no longer use the innovation.

The Empirical Record — Warnings

The conceptual model outlined above has its roots in the insights of Schultz (1975), who depicted adoption and diffusion as processes of adjustment to a state of disequilibrium created by the development of new technology. From this perspective, there are clearly two fundamental questions which need to be addressed by empirical research.

The first concerns the determinants of the ultimate adoption decision, which is essentially a static issue. In other words, once the adjustment process is complete, what determines whether a particular producer adopts or rejects a given innovation? In more aggregate terms, what determines the proportion of the potential adopter group to ultimately adopt the innovation?

The second question concerns the determinants of the adjustment process. In contrast to the first question, this is a dynamic issue. For innovation adoption, this question translates into: what determines the length of the time lag from development of the innovation to its adoption by the individual producer? With respect to the diffusion process, the equivalent question is: what determines the time lag between adoption of the innovation by the first and last members of the potential adopter group to do so.

Any attempt to deduce unequivocal conclusions about either of the above issues from the vast amount of empirical research on this topic invites frustration because of the diversity of findings. This confusion of results can be ascribed largely to poor methodology. To provide the basis for a more

selective and discriminating assessment of the reported results of empirical studies, this section is devoted to a discussion of methodological problems before returning to the substantive questions in the next section.

The bulk of empirical studies which address one or other of the two fundamental questions outlined above can be classified into one of the following categories.

A. Adoption Studies (concerned principally with adopter characteristics)

1. Cross-sectional (i.e., why do some producers adopt an innovation, while others reject it?)
2. Temporal (i.e., why are some producers early adopters, while others are laggards?)

B. Diffusion Studies (concerned principally with innovation characteristics)

1. Cross-sectional (i.e., why are some innovations widely adopted, while others are not?)
2. Temporal (i.e., why do some innovations diffuse more quickly than others?)

Cross-sectional adoption studies account for a significant proportion of empirical studies on innovation diffusion and adoption, but have contributed very little to understanding these processes. In most of these studies, an attempt is usually made to identify differences between those farmers who adopt, and those who do not. An almost exhaustive list of 'explanatory variables' has been investigated in these, albeit not all in the same study. The following examples taken from literature reviews by Jones (1967), Rogers (1983) and Feder et al. (1985) are only illustrative.

(a) Personal attributes of decision-makers as suggested by rural sociology theory (e.g., IQ, social status, attitudes to progress, cosmopolitanism, level of income or wealth, etc.), and/or by economists' expected utility theory and human capital theory (e.g., level of general and/or vocational education, attitudes to risk, etc.);

(b) Attributes of the firm, such as firm size, degree of diversification, form of business organisation, distance to markets, etc.;

(c) Attributes of the social system constraining adoption, such as social mores, inadequate communication channels, etc.;

(d) Attributes of the economic system constraining adoption, such as unsuitable tenurial arrangements, lack of credit, labour supply problems, etc.

Collectively, the results from such studies are distinguished first by generally low levels of overall explanatory power, and second by mutually contradictory findings concerning the importance of any given explanatory variable. While the diversity of human behaviour is notoriously difficult to

explain, there are other methodological reasons for these poor results.

One problem which is not specific to this class of studies is poor model specification. Many of the early studies used only univariate analysis, and most of those which used multivariate analysis included only a small subset of the explanatory variables required for a fully specific model. Consequently, the results are likely to suffer from omitted variable bias.

Another problem is the use of a binary dependent variable. Classifying a population of potential adopters into just two groups of those who have or have not adopted at a particular time, discards much of the information potentially available on the diversity of adoptive behaviour, thereby markedly reducing the power of any statistical tests. As noted below, this is solved in the following class of temporal adoption studies.

The most serious problem, though, is a conceptual failure by most authors to appreciate the significance of the dynamic learning process underpinning innovation adoption. At any stage during the diffusion of an innovation, much of the observed differences in adoptive behaviour will be due to different perceptions, based on different levels of knowledge at that moment, about the utility to be derived from adoption. Consequently, attempts to relate possible explanatory variables to individual adoption decisions before the diffusion process is complete are almost guaranteed to produce misleading results. Surprisingly, studies which commit this form of fallacy continue to be published, as is evident from the recent exchange between Braden and Eales (1986) and Rahm and Huffman (1986).

The problem can be avoided in one of two ways. One is to elicit subjective beliefs about innovation productivity, and to relate adoption decisions to these beliefs instead of, or as well as, to other more objective variables. To date, very few empirical studies have followed the pioneering work of this type by O'Mara (1971). More such studies are needed to better understand the determinants of inter-firm differences in the adoption decision time lag, and of the associated dynamic learning process.

The other approach involves avoiding the problem of differential knowledge levels by waiting until the diffusion process is complete. Analysis of the adoption/rejection decision can then proceed on the basis that all producers are fully and hence equally well informed. Two examples of this approach which are further discussed later in the paper are the studies by Perrin and Winkelmann (1976) and Gladwin (1979). Note that, in contrast to the first approach, these studies provide insights into the first fundamental, but static, question of

what ultimately determines innovation adoption.

The impetus for the second category of temporal adoption studies can be traced back to the findings of sociologists such as Ryan and Gross (1943) and Beal and Rogers (1960) that substantial time lags typically occur between availability of an innovation and awareness of its existence by potential adopters, and from time of awareness to time of adoption. Again, the aim of these studies is to contribute to a better understanding of the dynamic learning process by accounting for differences in adoption time lags.

Indeed, some of the foundations for the central role assigned to learning in modern models of the adoption process can be traced back to the group of early sociological studies which classified adopters into categories according to time of adoption. These studies represented an improvement over cross-sectional adoption studies by discarding a binary classification (adopt/not adopt) in favour of a multi-category classification (e.g., adopt early/mid/late/laggard). Unfortunately, most of these early temporal adoption studies still employed unsophisticated analytical techniques and, like the cross-sectional studies, suffered from the problems previously discussed of specification error and omitted variable bias. In a recent empirical investigation of the adoption of trace element fertilisers, Lindner et al. (1982) demonstrated that, notwithstanding conventional wisdom, it is possible to account for most of the variation in individual adoptive behaviour measured by the continuously variable time lag to adoption if analysis is based on a fully specified adoption model.

There are fewer examples of the third category of cross-sectional diffusion studies. Potentially, they also are subject to much the same sorts of problems arising from changing knowledge levels as are cross-sectional adoption studies. Both types of research can generate findings that relate mainly to the static issue of ultimate adoption levels, rather than the dynamic issue of the rate of diffusion, but only if the data are collected AFTER the diffusion process is complete. One difference between them, however, is the continuously variable nature of the dependent variable, compared with the binary adopt/reject variable for adoption studies. On the other hand, many more data are needed for this type of study, which helps explain why there are fewer of them.

The most powerful category of empirical research is the last. Temporal diffusion studies can be used to address both the static issue of ultimate adoption levels as well as the determinants of the dynamic rate of adjustment to this new equilibrium state.

The methodology which Griliches (1957) developed in his pioneering study of the diffusion of hybrid corn set the standard for this type of work,

and has been imitated in almost all intertemporal analyses of the spread of innovations. By fitting logistic functions to data on cumulative adoption level by year, he was able to estimate three parameters which adequately summarise the classic S-shaped diffusion curves for each state and crop reporting district. The three essential features of these diffusion curves and Griliches' corresponding measure of them were:

(a) the origin of the diffusion process (empirically calculated as the time when estimated cumulative adoption reached 10% of the ceiling level);

(b) the *rate of adoption* (a standardised measure of the average slope of the cumulative adoption curve);⁴

(c) the *ceiling* level of adoption (estimated maximum cumulative level of adoption as a percentage of total potential adoption level).

There are no serious conceptual problems with this approach, and the only real limitations involve the difficulty of obtaining the required data and of measuring relevant variables. Note, however, that it is not possible to investigate the reasons for interpersonal variation in adoptive behaviour with this type of approach. Hence, further temporal adoption studies also are needed to improve extension strategies.

The Empirical Record — Conclusions

Ultimate Adoption/Rejection Decisions

The view that individuals make irrational choices is widely held, and especially so with regard to adoption decisions. For instance, after reviewing many early studies of innovation adoption, the eminent rural sociologist, E.M. Rogers concluded (Rogers 1969):

Available evidence seems to indicate that peasant behaviour is far from fully oriented toward rational . . . considerations. Undoubtedly, however, the degree to which peasants are efficiency minded and economically rational depends in large part on their level of modernisation.

At least from the publication in 1964 of T.W. Schultz's seminal work, 'Transforming Traditional Agriculture', the prevailing view amongst economists is that, while potential adopters may make incorrect decisions out of ignorance, they generally are not irrational in the sense of making decisions contrary to their own best-interest. Many other social scientists now share this view. For instance, Rickson (1985) states that 'when technology is specifically designed to cater for the specific needs of small farmers, it was adopted very rapidly by those that would otherwise be classified as laggards'.

As long as the findings of methodologically flawed studies are ignored, there is compelling

empirical support for this emerging consensus that the final decision to adopt or reject is consistent with the producer's self-interest. The analysis by Griliches (1957) of the diffusion of hybrid corn was the first empirical study to provide convincing evidence of the importance of so-called economic variables in determining the ultimate adoption/rejection decision. To address this question, he investigated reasons for regional differences in the equilibrium, or ceiling level of adoption of hybrid corn, and concluded (Griliches 1960:279) that:

. . . variation in these ceilings across the country can be explained in good part by the same two measures of profitability: the average absolute superiority of hybrids and the average number of acres per farm planted to corn.

The analytical methods developed by Griliches have been imitated many times,¹ and in almost all cases substantially the same results have been obtained. Much the same picture emerges from the very extensive modern literature on innovation adoption in less developed countries. Ruttan (1977) reviewed the large number of studies of the spread of the package of innovations forming the basis of the Green Revolution, and from this review drew seven generalisations, including the following relating to adoption of high yielding varieties (HYVs): 'The new HYVs were adopted at exceptionally rapid rates in those areas where they were technically and economically superior to local varieties'. He could have added that ceiling levels of adoption of the HYVs in these areas also were found to be very high, but negligible or low in other areas. By contrast, Ruttan concluded that neither farm size nor tenure had constrained long-run adoption levels, although there is some evidence that smaller farmers and tenants were slower to adopt.

While innovation profitability is unquestionably an important, and perhaps even the single most important determinant of the final choice to adopt or not, the concept defined above of the potential adopter's best self-interest is much broader than just net financial returns. For instance, non-economists often overlook the fact that non-market inputs (such as family labour) have an opportunity cost determined by the foregone utility from alternative uses (such as leisure activities). A good exposition of other factors beside profit which also contribute to producer welfare is provided by Perrin et al. (1979).

One such factor which deserves special mention in the context of innovation adoption is risk. In a recent comprehensive literature review, Feder et al. (1985) note that 'empirical studies have very rarely

¹ For instances, see Mansfield (1961, 1969), Romeo (1975), Pardey (1978), and Jarvis (1982).

treated this factor, because it is difficult to measure'. Nevertheless, there is limited direct evidence as well as some indirect evidence that risk is an important consideration in choice of technique decisions. For instance, in a study of variety choice by Sri Lankan rice farmers, Herath et al. (1982) elicited subjective beliefs about yields as well as attitudes to risk, and concluded that choice criteria incorporating risk considerations performed much better than expected profit maximisation. Circumstantial evidence supporting this result is provided by Cutie (1976) who found location-specific dummy variables associated with different climatic areas to be significant. More generally, Newbery and Stiglitz (1981) have reviewed the large body of literature investigating the effect of risk on all aspects of farming, including tenurial arrangements, insurance, etc. Furthermore, given the demonstrated effect of tenure conditions on the distribution of risk between tenants and landowners, the 'tenurial obstacles to innovation' demonstrated by Newbery (1975) also support the view that perceptions and attitudes to risk influence innovation adoption decisions.

This notion that the decision to adopt or reject an innovation ultimately depends on what is in the producer's best-interest is deceptively simple. Some insight into the complexity actually underlying such a choice can be gleaned from the study by Gladwin (1979), who dissects in detail the reasons why a sample of farmers did not adopt a set of agronomic recommendations. For instance, it is easy to overlook differences between farms in resource endowments (e.g., equity capital, own labour, managerial skills, etc.) as well as personal preferences, etc., which influence the utility of innovation adoption.

For agriculture, the situation is further complicated by the location-specificity of many innovations. Paradoxically, this fact often seems to be overlooked by biological scientists. Just how subtle these location-specific effects can be is highlighted in a paper by Perrin and Winkelmann (1976), who reviewed a group of international studies, sponsored by the International Maize and Wheat Improvement Centre (CIMMYT), of the adoption of new crop varieties, and of fertiliser use. They concluded (Perrin and Winkelmann 1976: 891-892) that:

... productivity factors — agroclimatic zone and topography — are the most consistent in explaining why some farmers adopt new varieties, and others do not ... we are convinced that much more of farmers' adoption behavior could have been explained by productivity considerations had more accurate measurement of agroclimatic factors as related to productivity been possible. This became clear in retrospect ... within a small geographic area, we had

observed three villages ostensibly similar, with markedly different patterns of adoption: no adopters in one village, nearly all adopters in a second, and a mixed pattern of adoption in a third. Yet with better insight into agroclimatic factors affecting the production of new varieties versus old, this pattern of behaviour was understandable apart from considerations of information, prices, and risks ... These experiences force the recognition that within any farming area, there exists a wide range of expected yield increments from a given new technology. The differences can be the result of gradients in soil depth, texture, or other characteristics, differences in night-time low or daytime high temperatures in certain seasons, differences in disease incidence related to these factors, and so on.

Notwithstanding the overwhelming evidence that the ultimate decision of potential adopters to adopt or reject an innovation will be consistent with their own best-interest, it cannot be assumed that such private choices based on self-interest will automatically serve the broader social interest. The perception that there might be failure with respect to innovation adoption has resulted in a shift in emphasis in recent economic studies to focus on the so-called constraints to adoption.

Feder et al. (1985) provide the most recent review of this work, and note (p.255) the conventional wisdom that:

... constraints to the rapid adoption of innovations involve factors such as the lack of credit, limited access to information, aversion to risk, inadequate farm size, inadequate incentives associated with farm tenure arrangements, insufficient human capital, absence of equipment to relieve labor shortages ... chaotic supply of complementary inputs ... and inappropriate transport infrastructure.

Many of these constraints impede the rate rather than the ultimate level of adoption. Nevertheless, they cite considerable empirical evidence of suboptimal adoption levels even in the long-run when labour, credit, and/or other complementary inputs are not freely available in the market-place.

This form of market failure is one example of the broader problem created by complementarities in the adoption process. Obstacles to the socially desirable level of adoption can arise whenever the private benefits of adoption may be depressed by the decisions of others. Other instances include inappropriate tenure conditions, and inadequate investment in infrastructure such as transport and communication facilities. Imperfections in the marketing system that inhibit prices from signalling new opportunities to benefit from technological progress is another possible cause of suboptimal adoption which may be particularly important with respect to postharvest grain handling. In fact, as long as information can flow freely, the problems

of non-adoption are, in the long run, synonymous with those of economic development in general.

Rate of Diffusion

As noted in the introduction, the prospects for economic growth depend not only on whether new technologies developed by research are eventually adopted, but also on how quickly the diffusion of any adoption decision takes place. Once again, temporal diffusion studies such as that of Griliches (1957) provide some of the most convincing evidence on this issue.

Specifically, Griliches (1957), together with almost all of the dependent cohort studies, found that the rate of adoption (i.e., the rate at which the economic system adjusted to the new equilibrium) depended primarily on the *actual* extent to which the innovation was beneficial to potential adopters. Recent theoretical research by Lindner et al. (1979), Feder and O'Mara (1982), and Stoneman (1981) has provided an intuitively plausible rationale for this result. The essence of this theory is that innovations which are in fact more beneficial will generate more positive messages about the desirability of adopting than will less beneficial innovations.

The finding that rate of adoption as well as ultimate adoption level are determined primarily by the actual benefits of adoption to the potential adopters is by far and away the most important result to be culled from the empirical literature on adoption and diffusion. The inescapable implication from this result is that the overriding concern in the design and development of new technologies should be to ensure that any innovations are 'appropriate' to the potential adopters, in the sense that adoption will in fact be beneficial to them. Hence, there is a coincidence of interest in achieving speedy adoption as well as high levels of adoption.

Apart from the actual benefits to be derived from adopting the innovation, other factors which have been found to influence the rate of adoption include proxies for the cost of acquiring information (e.g., education level, distance to nearest adopter, availability of extension services, etc.), and proxies for the incentive to acquire information (e.g., farm size). Lindner et al. (1982) have shown that a great deal of individual adoptive behaviour can be explained if the estimation model is correctly specified to include such 'informational' variables.

Evidence from a number of other studies reviewed by Feder et al. (1985) is also consistent with the conclusion that constraints to the learning process slow down the rate of diffusion, but are not obstacles to the ultimate adoption of innovations. For instance, small farm size reduces the return to information gathering activities, and has often been found to be associated with laggardly behaviour.

However, except for those cases where a scale bias is embodied in the new technology, ultimate adoption levels have been found to be scale independent. Similarly, large fixed adoption costs and/or low levels of managerial education have also been found to inhibit rapid adoption, also no doubt because they are impediments to the learning process. By the same token, the speed of innovation diffusion will be faster, other things being equal, the more readily the innovation can be partially adopted, and/or the lower the costs of trial use for other reasons.

A final point: while empirical validation is difficult, recent theoretical research suggests that improving the quality of innovation-specific information is more important for rapid diffusion than increasing its quantity. This raises the possibility that efficacy of extension expenditure could be improved considerably by facilitating self-learning activities rather than attempting to substitute for them by bombarding potential adopters with so-called facts.

In conclusion, technology design rather than technology transfer should be the primary consideration because, if the former is successful, the latter will by and large follow automatically. However, it is in the social interest for technology transfer to be as rapid as possible, and policies which promote self-learning by potential adopters will help achieve this goal.

References

- Beal, G.M., and Rogers, E.M. 1960. The adoption of two farm practices in a central Iowa community. Ames, Iowa Agricultural and Home Economics Experiment Station, Special Report 26.
- Braden, J.B., and Eales, J.S. 1986. The adoption of reduced tillage: the role of human capital and other variables: comment. *American Journal of Agricultural Economics*, 68, 182.
- Cutie, J. 1976. Diffusion of hybrid corn technology: the case of El Salvador. Mexico City, Centro Internacional de Mejoramiento de Maiz y Trigo.
- Feder, G., Just, R.E., and Zilberman, D. 1985. Adoption of agricultural innovations in developing countries: a survey. *Economic Development and Cultural Change*, 33, 255-298.
- Feder, G., and O'Mara, G.T. 1982. On information and innovation diffusion: a Bayesian approach. *American Journal of Agricultural Economics*, 64, 141-145.
- Gladwin, C.H. 1979. Cognitive strategies and adoption decisions: a case study of nonadoption of an agronomic recommendation. *Economic Development and Cultural Change*, 28, 155-174.
- Griliches, Z. 1957. Hybrid corn: an exploration in the economics of technological change. *Econometrica*, 25, 501-522.
1960. Hybrid corn and the economics of innovation. *Sciences*, 132, 175-180.

- Herath, H.M.G., Hardaker, J.B., and Anderson, J.R. 1982. Choice of varieties by Sri Lanka rice farmers: comparing alternative decision models. *American Journal of Agricultural Economics*, 64, 87-93.
- Jarvis, L.S. 1982. Predicting the diffusion of improved pasture in Uruguay. *American Journal of Agricultural Economics*, 63, 495-502.
- Jones, G.E. 1967. The adoption and diffusion of agricultural practices. *World Agricultural and Rural Sociological Abstracts*, 9, 1-33.
- Lindner, R.K., Fischer, A.J., and Pardey, P. 1979. The micro processes of adoption. Presented at 9th congress, Australian and New Zealand Association for the Advancement of Science, Auckland, January 1979.
- Lindner, R.K., Pardey, P.G., and Jarrett, G.C. 1982. Distance to information source and the time lag to early adoption of trace element fertilisers. *Australian Journal of Agricultural Economics*, 26, 98-113.
- Mansfield, E. 1961. Technical change and the rate of imitation. *Econometrica*, 29, 741-765.
1969. *The economics of technological change*. Great Britain, Longmans.
- Newbery, D.M.G. 1975. Tenurial obstacles to innovation. *Journal of Development Studies*, 11.
- Newbery, D.M.G., and Stiglitz, J.E. 1981. *The theory of commodity price stabilization. A study in the economics of risk*. Oxford, Clarendon Press.
- O'Mara, G. 1971. *A decision-theoretic view of technique diffusion in a developing country*. PhD dissertation, Stanford University.
- Pardey, P.G. 1978. *The diffusion of trace element technology: an economic analysis*. University of Adelaide, Australia. M.Ag.Sc. thesis.
- Perrin, R., and Winkelmann, D. 1976. Impediment to technical progress on small versus large farmers. *American Journal of Agricultural Economics*, 58, 888-894.
- Perrin, R.K., Winkelmann, D.L., Moscardi, E.R., and Anderson, J.R. 1979. From agronomic data to farmer recommendations: an economics training manual. Mexico, Centro Internacional de Mejoramiento de Maiz y Trigo.
- Rahm, M.R., and Huffman, W.E. 1986. The adoption of reduced tillage: the role of human capital and other variables: reply. *American Journal of Agricultural Economics*, 68, 184-188.
- Rickson, E.R. 1985. Impact assessment and the role of the social scientist in rural development. In: *Smallholder rubber production and policies: proceedings of an international workshop held at the University of Adelaide, South Australia, 18-20 February 1985*. Canberra, ACIAR Proceedings No. 9, 22-29.
- Rogers, E.M. 1962. *Diffusion of innovations*. New York, Free Press of Glencoe.
1969. *Modernization among peasants: the impact of communications*. New York, Holt, Rinehart & Winston.
1983. *Diffusion of innovations (3rd ed.)* New York, Free Press of Glencoe.
- Rogers, E.M., and Shoemaker, F.F. 1971. *Communication of innovations: a cross-cultural approach*. New York, Free Press of Glencoe.
- Romeo, A.A. 1975. Interindustry and interfirm differences in the rate of diffusion of an innovation. *The Review of Economics and Statistics*, 57, 311-319.
- Ruttan, V. 1977. The Green Revolution: seven generalizations. *International Development Review*, 19, 16-23.
- Ryan, B., and Gross, N.C. 1943. The diffusion of hybrid seed corn in two Iowa communities. *Rural Sociology*, 8, 15-24.
- Schultz, T.W. 1964. *Transforming traditional agriculture*. New Haven, Yale University Press.
1975. The value of the ability to deal with disequilibrium. *Journal of Economic Literature*, 13, 827-846.
- Stonesman, P. 1981. Intra-firm diffusion, Bayesian learning and profitability. *The Economic Journal*, 91, 375-388.

Political and Social Constraints to Rate of Change in Grain Handling Technology in the Humid Tropics

Brian Fegan *

Abstract

Rice, the staple grain in Southeast Asia, is a political crop. National governments intervene in markets for factors of production and products in pursuit of political objectives of the state, the ruling coalition, and their allies. Grain 'losses' in postharvest handling and storage are political facts as much as technological or economic facts. Insofar as there are real rather than book losses of grain quality and quantity their major causes and solutions are political. A major constraint to full utilisation of existing grain-saving technology and adoption of new technology is state policy to win farmers' support by buying wet grain from 'farmers' at a subsidised price above that at which private traders could cover the cost of drying. This policy causes the state large capital costs as well as annual subsidies, losses of grain quality and quantity and waste of transport in both the state and private handling system, that would have been saved under policies permitting a price spread sufficient to cover the costs of maintaining grain quality. Market-oriented farmers, traders, storers, will use grain saving technology only when its costs to them are covered by the prices they receive, thus translating national 'need' for technology into business demand.

IN Southeast Asia, social constraints, anthropological factors, and customs will affect the rate of technical change in grain drying, storage, and transport systems less than political and market factors. Market-oriented farmers, traders, storers, transporters, and millers will fully use existing technology and adopt new technology only if the private gain to the operator exceeds his costs and is more profitable than alternative investments. Private operators will not do so if the state or the market does not allow a price differential sufficient to provide the essential incentives.

The use of quality-preserving methods by all private actors will be highest in grain-exporting countries that face a discriminating international market, or in countries that import a considerable proportion of high quality grain. In these countries, poor quality local grain is discounted. Adoption will be slowest in countries near self-sufficiency, where internal markets do not discriminate effectively against a high proportion of broken or slightly discoloured rice to give incentive to producers. High

income countries, where rice is a low proportion of household expenditure, discriminate more for grain quality; those with lower average household income and highly unequal income distribution will continue to have a large market for poor quality grain. The importation by rice deficit and balance countries of international rice 'quality' standards would emphasise aesthetic considerations irrelevant to nutrition but may neglect quality indicators like protein content and vitamin enrichment (by undermilling or parboiling) or the presence of aflatoxins or pesticides. This can result in poorer consumers bearing increased costs as a result of the pursuit of aesthetic quality characteristics with no improvement in objective welfare.

The Role of the State in Postharvest Technology

Quantified evidence is limited for where and why losses in grain quality and quantity occur along a line from paddy field through farm handling, drying, transport, storage, and milling. So far as I can determine from the literature, the call for new technology is from parastatal grain storage systems. There is no evidence of demand from the

* Anthropology Department, Macquarie University, North Ryde, N.S.W. 2112, Australia.

commercial sector, identifying the source of their losses and expressing their felt needs for the design of better technology or management. This requires explanation, since if the losses are real and large then they cause high costs to entrepreneurs. Boxall et al. (1985) note quantified data are limited on post-farm losses, and that some losses are not the result of lack of technology but of 'overriding factors, such as deficiencies of management, which defy easy quantification'.

In government, cooperative, and the largest private storage and milling complexes, some 'losses' are phantom or book losses that staff and management write off to rats, damp, mould, aflatoxins, sprouting, spontaneous combustion, poor milling recovery rates, and so on. In part, the problem is that employees corruptly collude with traders to record greater quantity and higher quality grain than physically enters and/or less quantity and lower quality than physically leaves storage to traders. Phantom losses are a matter for tight management, the auditors and the police. They are not likely to be affected by technology and should not be allowed to create demand for costly research, investment, or industry reorganisation.

Governments of all political colours in the region have intervened in input and product markets in pursuit of non-economic goals. This is especially so for rice, a sensitive crop which has large numbers of producers and consumers. In search of national rice self-sufficiency, they have promoted and subsidised land settlement, irrigation, research and extension, and rural credit. To quell rural insurgency and ethnic strife and attract farmer or ethnic votes, they have carried out land reservation, tenancy control, and land reform. To win farmer votes for the ruling coalition, they have subsidised credit, inputs, machinery, and product prices. To woo urban votes and avoid food riots and wage strikes, governments have subsidised the consumer price of rice. To win populist votes from farmers and consumers they have made scapegoats of Chinese middlemen and have tried to exclude them from grain trading in favour of state monopolies and indigenous traders. The latter are often less efficient and tied, by the allocation of licences, to the coalition in power. Some states use national procurement agencies to subsidise the salaries of officials, soldiers, and other favoured groups.

In general, state ruling coalitions and their technocrat advisers and business cronies have favoured large-scale technology because it is 'modern'. Moreover, it legitimises state intervention in politically sensitive markets, state control of revenues, and the allocation of profitable import licences, construction contracts, central bank subsidised loans, and control of monopolies

to cronies. These policies are political-rational from the point of view of the ruling coalition. They are not necessarily economic-rational from the point of view of efficiency in the use of society's resources, of the national benefit on foreign account, or of net social welfare.

In the late 1980s these state policies may be difficult to sustain. Falling commodity prices on the world market have reduced state revenues and caused external debt problems to several countries. Lender pressures, the free-market ideology of international lending institutions and of some internal economic planners, together with budget constraints, may signal abandonment of some of the more costly and unproductive forms of intervention. Rich countries like the USA, EEC and Japan subsidise their own grain farmers in pursuit of votes, and depress world grain prices by dumping surpluses¹. Poor countries find it expensive to support farm prices. Nevertheless, political considerations will continue to set the parameters within which markets are allowed to operate for the politically sensitive rice crop.

The slow adoption of rice-drying technology is a case in point. In several countries, the state procurement agencies, as a subsidy to small farmers, maintain a price spread between wet and dry paddy less than the full cost of drying. Large and medium sized private traders therefore do not invest in grain dryers and withdraw from grain buying in the wet season. Small grain traders buy grain from farmers, bulk it, and sell to the state agency, producing documentation that makes them out to be farmers. Other consequences are that farmers and small traders flood the state agency to sell wet grain, and face problems of queuing, delay, and grain deterioration that may result in discount for poor quality rather than wetness. Some farmers even withdraw from planting a crop that will be harvested in the wet season. The state agency is obliged to construct oversized storage and drying capacity and, as buyers of last resort, is left with large quantities of poor quality grain. Similarly, it is not rare to see politically caused problems being tackled by technological means, such as when engineers are pressed to design uneconomically large facilities for state agencies, and uneconomically small ones for farmers. A simple change of policy to allow realistic price penalties for wetness and poor quality would encourage adoption of appropriate national grains standards and the re-entry of commercial traders, leading to an increase in drying capacity, better use of existing storage, and dispersal of buying points to reduce queuing and waste of transport.

¹ Far Eastern Economic Review, 11 September 1986.

Appropriate pricing policies could save the state agencies both capital costs and annual subsidies, but because economically rational policy could cost the ruling coalition some farm votes, the introduction of technology is likely to be delayed.

The installation of bulk-handling technology, on the other hand, where it fits the political interests of the ruling coalition and enhances the power of the state, is likely to be accelerated, even where it is not economically rational. Bulk-handling technology, unlike drying, involves a string of technological items that can begin (as in Australia) with the combine harvester and truck in the paddy field. In Southeast Asia, farm and field size, drainage, soil consistency, and poor village roads tend to make this technology technically inappropriate. In these circumstances, bulk handling is more likely to be appropriate further downstream, possibly with rice traders on the main roads. Even beginning there, the string of investments needed to support such a system includes bulk loading equipment, trucks, weighbridges, unloading equipment, bulk storage, and reloading equipment. Heavy capital investment of this sort favours a large state, cooperative, or private monopoly operator. However, even in these circumstances a considerable proportion of rice does not leave the area where it is grown but moves in and out of storage and through mills in quantities that can be handled efficiently only in sacks. Consequently, a parallel system handling bagged grain will persist and may continue to compete, especially in countries where the relative prices of capital and labour make it more efficient.

Constraints to Use of Grain Saving Technology: a Systems Approach

Full utilisation of existing grain-saving technology and adoption of new equipment and management depends on a sequence of private actors from farmer through trader, dryer, transporter, storer, miller, wholesaler, to retailer being linked into a string by incentive to produce higher quality milled rice. That string is pulled by the size of the price differential between high- and low-quality milled rice set by consumer demand and state regulation. If price incentives are not large enough or not passed down, then crucial actors will not be pulled by incentive to exert managerial effort and invest capital. Looked at this way, it is apparent that state intervention to reduce the spread of prices reduces the strength of the pull (Fig. 1).

Published research has not concentrated on the size of the price pull and conditions necessary for the transmission of the pull along the string. Research has concentrated on the internal operations of each actor and how these might be

improved to retain the full quantity and quality of grain he/she receives. It has not examined in detail the transactions between separate actors, and crucially whether buyers and sellers can discriminate, at the point of transaction, paddy that will store well and produce good milled quality rice. Unless the actors on both sides of a transaction share fairly objective standards oriented to storing and milling quality, they cannot transmit relevant price incentives down the line, so that the potential string degenerates into a line of disconnected beads.

The Australian experience is a poor guide here. In the operations of Ricegrowers' Cooperative Limited, large commercial farmers deliver the whole of their output to a single buyer. In that transaction the farmer receives immediate feedback through price signals on his success in meeting the Cooperative's quality standards, which are tied to storing, milling, and consumer quality. All other transactions are internal to the Cooperative whose management takes pains to identify and correct in quantity and milling quality.

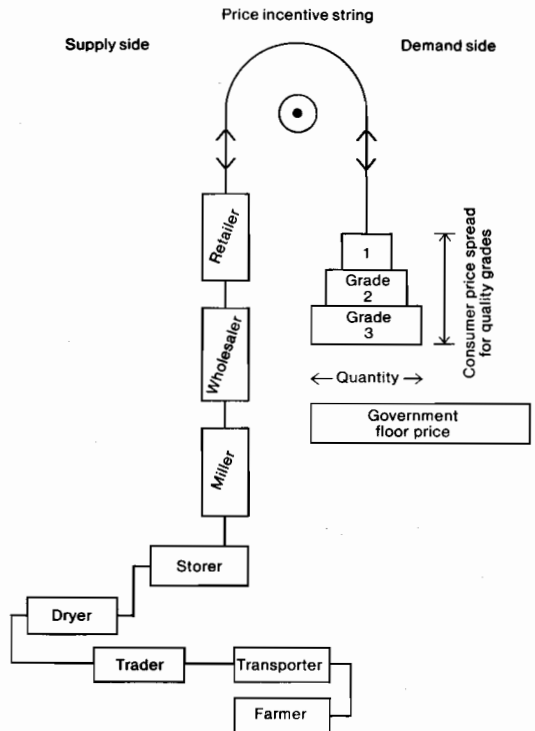

Fig. 1. The price incentive string for rice: full utilisation of existing grain-saving technology and adoption of new equipment and management depends on a sequence of actors being linked into a string by incentive to produce higher quality milled rice. The string is pulled by the size of the price differential between high- and low-quality milled rice set by consumer demand and state regulation.

In Southeast Asia, a great number of very small farmers do not sell more than a fraction of their crop. They use paddy as a currency to pay harvest labour, rent, irrigation fees, machine hire, inputs debt, consumer debt to stores and moneylenders, village dues, and deferred payments for services like school transport, barbering, laundering, ritual, etc. A proportion of these paddy payments within the village enters commercial channels via small seasonal traders who make bulk from many small purchases from 5 kilos to 2 tonnes. These first-level traders sort paddy by variety, cleanness, and discolouration, dry it, and transport it to sell to higher level traders.

At each transaction the buyers cannot know how many previous owners the paddy has had, their identity, or its history in terms of how it was harvested, threshed, and dried, and how long ago that was. Higher level traders receive paddy knowing that any large lot must be a mixture from diverse sources and has diverse histories that may affect its storage and milling quality. Traders are therefore loath to pass down full price differentials for paddy that appears on simple visual examination (by variety, colour, cleanness, lack of kernel discoloration, and dryness) to be of good quality. Neither buyer nor seller has more complex tests available than those of an experienced eye, guided by business acumen. Though there are many buyers, a seller faces transport costs to shop for a better price. Each side is suspicious of the sharp-dealing of the other and assumes information that would favour the other's bargaining is being withheld.

The transmission of price signals down the string is likely therefore to remain poor and to reduce the incentive for investment in quality saving technology. While mechanically dried paddy has reliably better storing and milling qualities than sun dried or air dried paddy, higher level dealers are unable to objectively discriminate drying method or drying quality by simple inspection. They are therefore suspicious of the sellers' claims and unwilling to pass on a price differential, discouraging low level traders from investing scarce capital in dryers. Grain dryers are therefore rare outside larger integrated operations that both store and mill, and are oriented to supplying to choosy foreign or urban quality markets. Entrepreneurs with such operations who can buy wet paddy of otherwise apparently good quality at a sufficient discount for moisture, can then as storers and millers have full knowledge of its drying history.

Barriers to Adoption

There are other barriers to adoption of mechanical dryers at lower nodes on the string than

the integrated storer and miller. Farmers and small traders consider mechanical dryers to be too expensive, too risky, and to have poor returns in comparison to alternative investments. Since there has been considerable design effort put into farm, village, and small trader dryers, but they have not been widely adopted, it is worth detailing these barriers so that design effort might be redirected to scales at which there is more likely to be demand.

Farm and Village Level

Farmers and small traders are aware that although in irrigated two crop areas one harvest occurs in the wet season, weather at harvest will not necessarily preclude sun drying. Over much of Thailand and the Philippines, wet season harvest occurs in the long days of summer, when there are many rainless days and especially rainless mornings. These, in combination with aeration under cover in rainy spells, are usually enough to effect drying to traditional levels that the market rewards. Moreover irrigation systems have often over-extended their command areas and suffered decreased flow in their headwaters due to deforestation, so that irrigation may be unreliable, or nominal two crop areas may be rotated to receive irrigation schedules in only one year in two, or two years in three. In single crop years a dryer would stand idle. The means of sun drying — concrete drying floors, basketball courts, surfaced roads, mats, and netting — are already available, and since sun drying has no fuel or maintenance costs will be used whenever possible. Small paddy sellers prefer to use household labour that has low opportunity cost to sun dry paddy rather than invest in a dryer or pay for custom drying services. Even dryer owners revert to sun drying when possible in order to save fuel costs, and their buyers know it.

Dryers at farm or village level off the main roads can be used for at most only six weeks during the local harvest. They stand idle for the rest of the year, and may be bypassed whenever sun drying is possible, or during breakdowns. Agricultural engineers tend to understate the capital cost of dryers in projecting capital recovery time by omitting the cost of a site, a building to house the machine and protect wet and dried paddy and fuel, plus weighing scales, tools, and spares. Hull-fired and powered dryers are impractical unless integrated with, or immediately adjacent to a mill, while electric-powered fans are impractical away from the grid or require additional investment in a generator.

The low throughput of dryers designed for farm or village level is too high for a small farm but may be too low for a village where harvests are bunched unpredictably by weather delay, floods, and the coincidence between onset of the first rains and the

irrigation schedule, and shortages of harvest and threshing labour occasioned by all these occur. This bunching causes queuing for a low throughput dryer so that, in response to drying delay, grain holders must use alternative drying methods or sell paddy wet.

Grain dryers are not readily adaptable to custom drying quantities smaller than a full batch, or to segregating the paddy of different owners in a continuous-flow system. Paddy owners, whose lots would seldom coincide with a full batch, suspect each other and the operator of sharp practice if lots are mixed, disputing the weight loss in drying. Petty grain owners have difficulty offsetting weight loss in drying plus drying cost against the price gain. They make unconscious comparisons with the home sun drying system where the paddy is not weighed and there is no cash cost. This is another source of disputes in custom drying. These organisational problems in custom drying make it a poor investment for a villager who wishes to maintain good social relations. There are no fewer disincentives to a farmers' or village cooperative, where the problem is compounded by difficulties in maintenance, management, and by village factions.

First level seasonal paddy buyers in the villages operate on small capital, with nothing more than hired scales, sacks, and some cash. They are unwilling to invest in a dryer for wet season harvest because the capital tied up would not be available for margin trading in either wet season or main harvest.

High Price and Opportunity Cost of Capital

Except where state-subsidised credit is available for dryers, potential investors face high real-interest rates and high opportunity cost of capital that could have been used in alternative investment with higher total return or lower risk. Dryers do not produce a year-round cash flow for debt service, making both lenders and borrowers prefer other investments. However, the crucial disincentive to the small trader is that custom drying is, for the reasons given earlier, organisationally difficult, while if he/she both trades in paddy and dries some of it, those who buy paddy from him/her are unable to identify which has been mechanically dried and therefore unwilling to pass on whatever commercial improvement there is in milling quality of mechanically dried as against sun dried paddy.

Farmers, first level village traders, and main road traders are not single product specialists but generalists, directors of small diversified conglomerates that try to maximise net household income from all sources. To that end, they keep several operations at any one time, and shift capital and labour between them seasonally. They try to

diversify investments to spread risk and provide year-round employment for all household members, capitalising their children by education to enter the non-seasonal urban sector. They will not invest in dryers, whatever their projected pay-off periods, unless the long run payoff to the household is higher and less risky than alternative investments. These include: buying land; acquiring usufruct to land as the interest on a loan; buying agricultural machinery for custom hire (irrigation pumps, tractors, cultivators, reapers, threshers); purchasing livestock; grain trading at margin in season; buying a truck, motor tricycle, or jeep to ply for freight and passengers; and moneylending at rural rates of interest as high as 10% per month.

Paddy Traders

From the point of view of a paddy trader who rolls over capital quickly at small margins in season, investment in a dryer ties up trading capital in the wet season when the machine could be useful, but crucially in dry season harvest when it is not. Alternative investments that increase turnover all year round include increased storage, extended drying floors, and trucks to search the countryside over a wide area when no paddy is being harvested locally and which can haul other cargo such as fertiliser, cement, and lumber.

In Central Luzon in the Philippines, paddy traders with capital have, since about 1979, devised an integrated inputs and services operation to increase their market share of local paddy. In the late 1970s cheap institutional credit for inputs and machines dried up to farmers at about the same time as IRRI's light, axial-flow threshing machines became available. Input dealers and custom-hire cultivator owners were faced with a declining market from farmers unable to pay at the time of purchase or service and with poor repayment records. They shifted to advancing fertiliser and farm chemicals on credit, on condition that their own or an agent's threshing machine have the exclusive right to thresh. The thresher collects 6% of the harvest plus principal and interest on inputs and machine services loans, calculated in paddy at the low harvest price. This secure collecting mechanism has allowed rural entrepreneurs to operate in a monopsonic way across linked markets at secure margins. In addition, the system allows rural entrepreneurs to make advances at interest in the planting season when no grain is moving but recover them for trading on margin at harvest time.

Barriers to Bulk Handling by Smaller Traders

Similar considerations apply to investment in bulk-handling equipment at any level below that of

the major central state or private storages. Paddy will continue to leave farm and village in sacks, being collected in dribs and drabs by small traders who grade, dry, make bulk, and transport small quantities to sell to second-level traders along main roads. Main-road traders will be unwilling to invest in bulk-loading equipment, when they receive, weigh, store, and handle paddy on and off trucks in sacks. Because bulk trucks plying into central storages would be only one of their outlets, investment in loaders would face low utilisation and returns. Except in labour shortage areas, traders have a ready supply of labourers who contract to handle sacks and spread paddy for drying on a per sack, piecework basis, where costs are calculable and strictly tied to the volume traded.

A crucial bar to bulk transport starting from the level of the trader is that the commercial transaction between buyer and seller cannot be delegated to an employee, such as a truck driver. That transaction depends on a negotiation between buyer and seller to settle the price of grain, taking into account variables such as variety, dryness, discoloration, foreign matter, and price trend per tonne in that day's market. An associated difficulty concerns agreement about the exact weight, for the distant buyer of the load is unlikely to accept the weight by the seller's scales, or the seller by the buyer's unseen weighbridge.

Bulk handling is therefore unlikely to be practicable between separate parties. It will occur only when grain moves between different points under the one ownership. That condition is likely only between state bulk storages, for instance a central warehouse in a rice surplus area and a distant storage at a city, port, or deficit area. Private contractors are unlikely to invest in bulk trucks unless their design allows them to be used for other freight, or bagged commodities, when no bulk rice is moving. Under Southeast Asian conditions, where paddy and rice have many entrepreneurial buyers, such an organisation would have to maintain weighbridges at both ends to avoid diversion of part of the cargo.

The total new capital requirements for bulk transport, loading and unloading equipment, weighbridges, storages, and internal handling will be large. They will divert capital from alternative development uses and force up its price. It is not clear what national benefit would offset these costs plus associated costs of upgrading roads, railways, bridges, and ports to handle heavier transport units. It is clear that, to the extent that bulk handling succeeds, it will throw idle existing private stocks of storage and transport or at least limit the expansion of private capital in monocrop areas. At the time, it will displace the labour of large numbers of

landless rural workers, and contribute to the reduction of rural wage rates.

The String Approach: Implications for Use of Grain Saving Methods

The approach holds that all operators from harvest through to retailer seek private gain as mutually suspicious isolates but can be linked together by passing a string of incentive for quality production through them. The strength of the pull on that string (Fig. 1) is the size of the price differential consumers are ready to pay between high- and low-quality rice. Transmission of the pull can occur under two conditions. In the southern Australian rice-growing region, Ricegrowers' Cooperative conducts all operations between farmer and wholesaler; there are no transactions between separate entrepreneurs. In Southeast Asia this is neither possible nor desirable because of different geographical, institutional, and political factors. The alternative is to transmit the pull by defining which characteristics that produce commercially significant storing and milling quality can be readily agreed between buyer and seller and transmitting, through price differentials, an incentive to achieve them.

That this approach is not far from reality is borne out by trends in the industry. Mechanical dryers are not adopted by farmers or small traders because they cannot get buyers to pay a premium above that for sun-dried paddy. However, entrepreneurs with integrated paddy buying, storing, and milling oriented to the quality market, do invest in dryers. This indicates that where the technology results in private gain because the paddy is under one ownership it is adopted, but that the string is not pulling between buyers and sellers down the line.

It does not seem likely that tests that accurately predict paddy storing and milling quality, or that can discriminate between sun-dried and mechanically dried paddy, will become cheap and simple enough for the great number of small transactions that occur towards the bottom of the string. In the absence of these, and of commercial trust, it is likely that grain quality will not be quickly raised.

In rice-exporting countries, open to the standards of the international market and its large price differentials, quality rice is produced. Among the ASEAN countries, there is least state intervention in pricing and grain handling in Thailand. It has historically been able to produce international standard rice for export, using existing technology, from its dry season harvest. It would be instructive to examine interaction between price differentials for quality and state intervention, such as by

imposition of rice export taxes, to learn how the pull of the export market was transmitted down through millers, storers, dryers, and traders, to farmers, what proportion of the total milled rice is of high quality, and whether high-quality rice passes along channels separate from those producing for the internal market. It would be more instructive to examine whether that pull is transmitted successfully to those areas of Thailand that now produce a wet season crop.

The Philippines has been insulated from world market standards that focus on proportion of brokens and head rice by its being a small importer until the last decade when it has been in rice balance and an occasional exporter. Domestic consumers were prepared to pay a premium for varieties of special flavour and cooking quality, but were not fussy about whole grains for ordinary varieties. This permitted sloppy milling and makes it hard to determine whether quality was lost from causes other than poor milling while most harvests were in early dry season and were sun dried. That Thailand achieved high milling quality grain with sun drying makes it probable that sun drying was not in itself the culprit, though details of technique may be involved. Reports of a recent trend to demand whole rice and discount that of the same variety and colour with a higher percentage of brokens are associated with a fall in the real price of rice and the proportion of household expenditure it accounts for among the better off. However, trends to a widening income distribution, with a fall in the real income of the bottom percentiles, may mean that, rather than a general shift to demand for whole rice, a stratified demand is emerging, with the better off adopting international standards and the poor happy to buy cheap rice, identical in all respects but wholeness, for everyday consumption. I have been unable to find reports of broken rice being unsaleable to consumers or diverted by lack of demand to lower price uses like raw materials for noodles, confections, and animal feeds.

The very small farms of Java and Bali and low opportunity cost of labour there make grain saving with traditional labour-intensive techniques more effective than in the larger farms of some parts of Malaysia, the Philippines, and Thailand. Similarly, capital-intensive grain technology is least economic there.

If the string approach is correct, then it has the following implications if different actors are to create conditions for old and new grain-saving technology to be fully used:

1. State Policy

- a) Allows and encourages price differentials between high- and low-quality rice sufficient to

- let the string pull all actors to produce for quality.
- b) Does not subsidise farmers to deliver wet or poor quality paddy. Allows price differentials for dryness and quality at all levels.
- c) Does not intervene in the market to displace or restrict efficient private grain handlers and processors because of their ethnicity.
- d) Promulgates a set of indicative objective standards for milled rice and devises and promulgates a set of simple, cheap, and objective tests for predicting storing and milling quality of paddy.
- e) Promulgates, through agricultural extension systems and those involved in grain transactions, recommendations for maintaining paddy quality and avoiding losses in quantity and quality.
- f) Makes spot checks at mills for excessive pesticide residues and destroys such grain without compensation, so that millers are likely to test for pesticides at purchase and to reject contaminated paddy.

2. End Product Markets

- a) Consumers discriminate between high and low quality rice of standard varieties by a price spread sufficient to give millers a quality incentive.
- b) Demand sufficient quantity of higher priced rice to affect millers operations.
- c) Retailers and wholesalers pass on the price differentials to millers.

3. Millers

- a) Are aware that the quality of incoming paddy, as well as the milling process, affects recovery rates and prices.
- b) Face price differentials for standard varieties of rice that make it profitable to:
 - i) invest capital and management in milling improvement
 - ii) invest capital and management in quality conserving in storage
 - iii) invest capital and management in determining milling quality of paddy before purchase.
- c) Have reasonably objective tests for predicting milling quality of grain at purchase.
- d) Pass on price differentials for milling quality down the line.

4. Paddy Storers and Traders

- a) Face price differentials as sellers that encourage them to strive for high storing and milling quality in their own operations.
- b) Have available cheap and simple tests for predicting milling quality of grain they buy.
- c) Pass on price differentials down the line.
- d) Have available drying, storage, and protection technology that is reliable and costs less per tonne

given predictable throughputs than the price differential they face as sellers.

5. Paddy Dryers

- a) Face a price differential between wet and dry paddy that covers the full cost (site; housing for machine, stocks, and fuel; machine and installation; fuel and power; costs of maintenance, labour).
- b) Face buyers who will pay a premium for mechanically dried over sun-dried paddy sufficient to make fuel and power costs worthwhile, even when sunny weather permits sun drying.
- c) Operate as paddy buyers so that all grain coming to the dryer is under one ownership.
- d) Are located in, or close to, an irrigated area that harvests every wet season, but can extend the drying season to at least two months by tapping areas with staggered irrigation and therefore harvest timing.
- e) Are in countries with wages high enough to substitute capital for labour in drying.
- f) Have a management system providing incentives for key staff to control quality.
- g) Are located on main road, not in an off-road village, so as to extend drying season by tapping a wider area.
- h) Are integrated with, or adjacent to, a rice mill for access to hulls or connected to public power grid to avoid capital and fuel costs of electric generators for fans.
- i) Sell bulk of product onwards towards a discriminating urban or foreign market rather than mills serving non-discriminating rural poor market.
- j) Have an integrated paddy trader, dryer, storer, miller operation where discrimination in purchase price occurs once for the whole operation, grain has a single owner, full price differentials are passed down within the operation from miller to dryer, and operator's management is reflected in sales.

6. Characteristics of Marketable Dryer Technology

- a) Daily throughput sufficient to serve a large integrated grain trader, storer, and miller.
- b) Full capital cost (see above) plus fuel, maintenance, and labour per tonne of throughput in a six to eight week working season is lower than (i) value added to, or losses avoided in, storing and milling quality, and (ii) storage cost of holding paddy from last dry season harvest. Annual return to dryer is higher than (i) market interest rate, and (ii) operator's opportunity cost of capital.

7. First and Second Level Traders

- a) Can discriminate probable storing and milling quality of paddy.
- b) Face clear price differentials by quality.
- c) Have sun-drying facilities and recleaning fans to upgrade and preserve quality.
- d) Can sell-on to buyers with dryers if sun drying is inadequate
- e) Pass on price differentials to farmers.

8. Farmers

- a) Face clear price differentials by quality.
- b) Are made aware through extension and price differentials of varieties whose total benefit (yield \times farm gate price, for variety with good storing and milling quality) is higher than alternative varieties.
- c) Are aware of need for speedy drying to prevent quality and price loss.
- d) Have sufficient harvest and threshing labour or machines to avoid deterioration.
- e) Have facilities available to dry to good quality or can sell to those with such facilities without delays in locating a buyer, and without queuing that would cause deterioration.

9. Irrigation Systems

- a) Stagger release dates of water into canal branches so as to stagger wet-season harvest dates and extend harvest period, avoiding bottlenecks with harvest labour, threshing machines, and dryers that cause grain deterioration.

10. Research

- a) Continues to concentrate on improvement in drying, handling, and storage.
- b) Ignores claimed losses in government and cooperative storage, which are likely to be phantom losses or due to deficiencies in low-incentive management systems.
- c) Concentrates on the private sector and ascertains where real losses in quantity and quality occur, seeking liaison with private sector associations to determine felt needs in order to design technology and management for demand rather than undefinable 'national need'.
- d) Produces simple, cheap, and reasonably objective tests that predict storing and milling quality to guide buyer and seller in transactions that constitute the string.

Implications of the String Approach

The string approach to systems analysis indicates that there will be many situations where mechanical drying could save grain in the wet season but private operators would find it unprofitable to invest in the equipment needed. It would be unwise for the state

to intervene by setting up state-owned dryers in such situations, as they will need a subsidy. The state would be wise to first investigate whether any of its own actions prevent the string pulling or whether it can intervene to make it pull better.

It is likely that if the string can be made to work, it will be unable to pull for a continuing large proportion of wet-season-harvested rice. This will probably accelerate trends to emergence of parallel systems of postharvest grain handling. One system will be oriented to production of quality rice for a discriminating international and prosperous urban market, if the premium is sufficient to cover costs of pursuit of quality. However, international and urban consumers who can afford to be fussy about the percentage of broken and head rice will demand varieties with superior flavour and cooking qualities, like the Basmati special grade in the Indian subcontinent. Storers and millers already specialising in high priced varieties probably have the best quality maintenance at all stages, as the same sized physical loss costs them more. Parallel to this will remain a large domestic market for ordinary varieties, with the range of price differentials for broken and colour reflecting the range of income distribution in the country. Where the proportion of poor households is large, the market in countries near self-sufficiency will continue to be relatively indiscriminating about a reasonable proportion of broken for ordinary varieties.

In rural areas, where households hold paddy and have it milled in custom lots of 100–200 kg each month, households will continue to tolerate sloppy milling. Millers operate two systems for custom milling. In the first, the paddy owner takes the rice and leaves bran and millings as the miller's fee. In the second, the paddy owner pays a cash milling fee and is returned the bran and millings for livestock feed as well as his rice. Small mills with a profitable sideline in animal feeds have an interest in poor recovery rates, and specialise in the no-fee system. Farmers and rural households with livestock tolerate poor recovery rates in the second system because what they lose in rice they gain in chicken and hog feed. Rural households can buy better milled rice of a superior variety in the market for special occasions.

Social Cost and Benefit Analysis

A. Net Social Benefit

A two-party analysis of net social benefit taking into account 'producers' and 'consumers' net gains has limited heuristic usefulness and is unlikely to be a useful guide for policy. It is difficult to quantify what the present losses of quantity and quality are,

let alone how much technology is likely to change the supply side. Prices are not set by supply and demand, but by state policy and the international market. Moreover, neither 'producers' nor 'consumers' are a single interest group. Technology change policy needs to disaggregate 'producers' and 'consumers' to take into account which interests will gain and which will lose. This may be politically important to government, since 'producers' include farmers, who have many votes, and grain handlers of various kinds, who have few, but may be politically influential in party organisations or by political donations, or, conversely, may include members of a disfavoured ethnic group. Similarly, 'consumers' include for an exporting or importing country net gains on foreign account. In both these and rice-balance countries, well-off consumers may prefer better quality milled rice. But poor urban and rural consumers face costs of pursuit of quality improvement passed on to them in higher prices for ordinary varieties that have been upgraded in aesthetic but not nutritive quality.

B. Net National Benefit on Foreign Account

Quantified evidence for physical losses of grain is limited, much consisting of worst-case projections. It may include phantom losses in government storage. These are matters for enterprise management and the police, and should not be translated into a call for investment in new technology. It is puzzling that there is no evidence that private sector handlers complain of large losses and exert a demand for loss-saving technology. That many private traders withdraw from the market for the wet-season crop, indicates that state price policy makes drying unprofitable and/or that it is cheaper to hold stocks from last dry season than to dry in the wet season.

It is difficult to calculate changes in supply that might result from technology adoption. This is because of poor evidence of present losses, uncertainties about what improvements in supply would result from investment within a single function or enterprise, and whether the level of adoption would suffice to make a significant supply difference, given the problems of pulling the whole string. It is quite utopian to make projections of near total savings of present estimated losses. The crucial reason is that the number of transactions and brief ownerships through which paddy passes in Southeast Asia as it is accumulated in tiny lots from myriad small farmers and those they have paid in paddy, means commercial lots are necessarily mixed. Under those conditions, the string will pull weakly at the lowest couple of levels. Put another way, farmers will not have transmitted to them strong price incentives to improve the quality of that

fraction of the crop that they sell direct. Individual large farmers whose marketed surpluses are large enough to make an economic freight load, may bypass first level traders and deal direct with a main road trader or integrated trader-storer-miller, to get a better price for an unmixed lot of good quality. In the rare instances where farmers' cooperatives work, they may be able to collectively deliver to the urban-oriented quality market.

Net national benefit will be positive only if savings in grain from the new technology exceed the amortised capital cost of the equipment plus the net difference in handling costs over traditional drying, handling, and storage. Grain exporting countries will benefit on foreign account by the amount of grain savings made available for net export, less the foreign exchange costs of the capital and interest for imported equipment, and its fuel. Non-exporters of grain will benefit on foreign account if grain savings reduce imports by more than the technology's foreign account costs. National governments will need to examine carefully the foreign account costs if the introduction of bulk handling requires imported trucks, trains, ships, loading and unloading equipment, weighbridges, grain elevators, construction materials for storage silos, grain terminals, and upgrading of roads, bridges, railways, and ports to carry heavier units of traffic. Large amounts of capital would be diverted from alternative development uses, and push up interest rates.

C. Social benefits and costs: who gains, who loses?

Net social benefit may be small if large scale technology merely replaces multiple small private storages of farmers and small handling entrepreneurs by large new storage requiring high capital outlay by the state or large entrepreneurs. The distribution of private benefits from bulk handling will favour a few large urban-based capitalists and suppliers of new inputs and credit at the expense of a larger number of small rural-based entrepreneurs and the labour displaced. Labour displacement by capital-intensive technology will drive down the already low rural wage rates.

Net social benefit of mechanical drying would be higher and the private cost lower if the grain savings from reducing losses were supplemented by alternative uses of the equipment outside the brief wet-season harvest. Non-grain commodities, such

as fish, meat, mushrooms, and fruit and vegetables, that are dried in India and China, are possibilities for multi-purpose dryers. A technology using rice hulls, rather than petroleum fuels or electricity would reduce national petroleum imports and private running costs, while disposing of bulky hulls that in some places are dumped by roadsides. It should be borne in mind that mechanical drying will not be able to save a significant proportion of soaked, sprouted, and mud-coated grain that has lodged during typhoons and floods.

The distribution of private benefits from mechanical drying will depend on how any positive net savings in grain are distributed between grower, dryer, storer, miller, and consumer, and between capital and labour. Where sun-dried paddy faces a similar price to mechanically dried grain, a shift to capital-intensive dryers will redistribute income from labour to capitalist.

Areas for Research

The string approach outlined above helps predict what elements of the total grain handling system are necessary for existing technology to be fully used and new technology adopted. Some deficiencies indicated are:

1. The system needs simple, cheap, and reasonably objective tests that predict the storing and milling quality of paddy, to guide buyers and sellers.
2. To predict demand for technology, we need to know whether trends in national rice markets show a widening or narrowing spread for 'quality'.
3. To predict where technology will be demanded, we need to know whether the spread in rice prices is passed on to paddy price spreads at various nodes along the string.
4. To predict demand for technology and enable design for demand rather than vague 'national need', we need to know what are the perceived grain-saving problems of the various operators in the private sector.

Reference

- Boxall, R.A., Calverley, D.J.B., and Tyler, P.S. 1985. Loss assessment — towards a fuller comprehension of post-harvest loss. In Champ, B.R., and Highley, E., ed. Preserving grain quality by aeration and in-store drying: proceedings of an international seminar, Kuala Lumpur, Malaysia, 9-11 October 1985. Canberra, ACIAR Proceedings No. 15, 133-140.

The Effects of Regulation on the Rate of Adoption of Technological Change in Postharvest Handling of Grain

W. Horrigan *

Abstract

The adoption of new technology is dependent upon that technology being created, on it being made available in a form that practitioners can use effectively, and on those users having incentives for its introduction. Government policy, in the form of regulation of certain quality or plant quarantine criteria or in response to cost-pressures in administration of controls, on grain moving in national or international trade has, in some instances, been seen as such an incentive, as well as a stimulus to further research. Regulation has achieved benefits through encouraging technological change in those countries where there have been adequate resources, both economic and in terms of scientific, technical, and management talent. However, the inbuilt conservatism of regulatory bodies can also act as a disincentive to the introduction of new technology by suppressing entrepreneurial innovation through pre-occupation with inflexible rules.

Most countries involved in international trade in grains or other agricultural commodities have some form of legislation governing imports, usually in the form of quarantine controls designed to prevent the introduction of plant pests. Countries which engage in the export of agricultural produce often include in the legislation provisions for regulation of exports, or have separate ordinances with respect to what might be broadly termed quality. These countries include a number of tropical or subtropical states (Hall 1970). In this context, quality includes insect infestation and insect damage, as well as other grading factors such as moisture content. In this paper, I will discuss the effects of regulation from an Australian perspective, with particular reference to controls on grain exports, the benefits regulation has conferred, conditions which made it possible, and seek to draw some conclusions applicable to the humid tropics.

Crosson (1975) defined the conditions necessary for adoption of new technology as follows:

- the technology must be created;

- practitioners must know how to use it efficiently;
- those users must have incentives to employ it effectively.

While Crosson was discussing farmers' production in less-developed countries these conditions can be shown to have applied in relation to the introduction of Australia-wide pest control in the grain and related industries. The technology that made this possible was the introduction of the insecticide malathion as a disinfestant and, more importantly, as a protectant for grain received from farmers into each State's central handling system. It was the research efforts of the scientists who discovered the insecticidal potential of this chemical, plus the entrepreneurial expertise of the pesticide manufacturer, which provided the means to achieve effective insect control in stored grain. The demonstration by the central handling authority of one of the states that malathion could be admixed with bulk grain within the constraints of normal receipt and handling procedures and give cheap, effective control under field conditions essentially made the technology available to other grain handlers both large and small.

The incentive for introduction of this new

* Department of Primary Industry, Edmund Barton Building, Barton, A.C.T. 2600, Australia.

technology was the potential loss of important overseas markets for wheat. At that time, two major importing countries had signified their intention to cease the purchase of Australian wheat if it could not be delivered in an insect-free condition. The catalyst which ensured the general adoption of malathion admixture was Federal Government policy, in response to wheat industry representations, to introduce regulation of wheat exports in 1963 to ensure freedom from live insects or any other condition which could render that grain unfit for export. In this context, while market concerns were the primary incentive to action, regulation was an important part of the process of introduction of appropriate technology. The introduction of automatic sampling of export grain in both the United States of America and Australia may be cited as a further example of the use of regulation as an incentive to adoption of new technology. The Federal Grain Inspection Services (FGIS) of the United States Department of Agriculture (USDA) wished to standardise sampling of export grain by requiring all export elevators to install automatic sampling devices which took moving cuts across grain streams (so-called pelican-type samplers). Such devices were available, were already in use in some export elevators and in other grain handling facilities, and were believed to provide a more consistent and representative sample than other methods.

The U.S. authorities were reacting to demands from overseas buyers of grain for improvements in the grade quality of shipments. FGIS introduced a rule that only pelican-type samplers were to be approved for sampling export grain subject to government certification. As an added incentive to early introduction, FGIS proposed that, after a period of two years to allow time for purchase, installation, and any necessary modification of plant and equipment, export certificates would, where applicable, be endorsed to the effect that samples were not drawn by approved means (Orr, pers. comm.). This course of action had the desired effect and only approved sampling devices are now in use in the USA.

In Australia, automated sampling and sample inspection is being introduced for the same reasons as in the USA, but with the additional purpose of reducing regulatory costs through the employment of fewer inspection personnel than is needed with manual methods. The technology is available and in use in some new or upgraded terminal elevators, as well as overseas. Its introduction in all terminals is currently being achieved through Federal regulation which requires registration of larger export premises and the provision of specified inspection facilities, including automated sampling.

Regulation as a Stimulus

The introduction of regulation in the export grain industry in Australia had a number of effects, both direct and indirect, notably on research into control of stored products pests. Following an initial adjustment period after the introduction of export controls, during which malathion admixture came into effective use at all central grain storage sites, the concept of a nil tolerance for the presence of live insect pests emerged. By nil tolerance is meant that official samples taken for examination during loading of export grain must be free from live insects. Where live insects are detected, grain remaining in affected storage units is rejected and must be disinfested before being represented for export. As a result, the achievement of nil tolerance became an integral part of pest management in the grain handling and associated industries.

Various authors (e.g. Hall 1970; Bailey 1981) have referred to the need to instil a mental attitude throughout appropriate industries that accepts the need for effective insect control. I submit that regulation in Australia in large part was responsible for achieving such an attitude. It also resulted in an expectation by overseas markets that Australia would continue to supply insect-free grain. This was to have particular implications when resistance inevitably developed to malathion.

An important concomitant to the introduction of nil tolerance on export industries has been the effects on domestic industries and farms. Background infestations from these sources cannot be isolated from the central storage systems and export stocks. Various strategies have emerged in each State to deal with this, ranging from full on-farm inspection and control of pesticide usage by farmers in Western Australia, through to less direct action such as more research into the impact of background infestations and appropriate ways to deal with them at the export system level.

Research into appropriate methods of control received much greater impetus with the emergence of economically significant levels of resistance to malathion in some strains of insects (Champ 1979). This research was not only into the availability of alternative chemical protectants but also into methods to achieve their more efficient use, and on a range of alternatives to these materials. For development of new insecticides, well established collaborative arrangements between State and Federal research organisations, pesticide manufacturers, handling authorities, and exporters provide for trialling at laboratory, pilot, and silo scale stages, leading to international and national acceptance and eventual adoption as components of the grain pest control strategy.

Studies to prolong the effective life of existing protectants have included research on sampling, grain drying, cooling by ambient air aeration, and application methodology and technology as a means of improving target dose rates. Research into alternatives to chemical protectants has covered the use of modified atmospheres such as carbon dioxide and nitrogen, including the sealing of conventional storages and the use of plastic-lined bunkers, temperature modification by way of refrigerated aeration or heat disinfestation, and more efficient and effective use of the fumigants methyl bromide and phosphine. This work has also found valuable additional application in the sealing of shipping containers and treatment of goods in them with both traditional fumigants and carbon dioxide. In addition, the economics of the various options made available by researchers have been examined in terms of cost-effectiveness of insect control at on-farm, central storage, and seaboard terminal levels (Love et al. 1983)

Legislative controls on grain exports from Australia have thus had the effect of establishing general acceptance of the need for maintenance of quality as a prerequisite to gaining and maintaining access to overseas markets. Since the introduction of malathion, Australia has gained a reputation as a supplier of dry, clean, and insect-free grain, a marked change from when Australian cargoes were synonymous with heavy and varied insect infestation. The grain industry, farmers included, have come to recognise the value of regulation in maintaining this reputation, and generally support its continuation. In addition to Australian perceptions, importers and importing country authorities generally view government regulatory inspection activities as providing them with an independent assurance that goods will meet contractual and plant quarantine requirements. Regulation in this sense has therefore taken on an additional and legitimate role; that of trade facilitation.

One of the incentives for the introduction of alternatives to protectants for insect control was public concern, translated into national regulation, regarding pesticide residues in foodstuffs. An important spin-off from increased research into these alternatives has been the demonstration to industry at all levels of the need for long-term planning. The options now available in Australia mean that the industry has the ability to meet the challenge of continuing to supply insect-free products in the foreseeable future. While existing storage can be modified to extend its useful life, past mistakes are not being repeated during the construction of new facilities, which now have pest

control, including hygiene maintenance, as an integral part of the design.

Conditions Needed for Successful Regulation

The continuing success of regulation in Australia can be attributed to the highly institutionalised environment in which grain is marketed, the export orientation of the industry, and the significant economic contribution of grain to the national economy (Love 1983). Under a system whereby most grain is received into State central handling systems, and statutory or cooperative marketing authorities are responsible for most of the selling, an environment has existed which has engendered the political will necessary for imposition of controls. By contrast, the USA, which dominates world markets and is Australia's major competitor there, despite regulation of exports had not enjoyed a good reputation for supplying clean grain. The USA controls a much wider range of grain quality criteria than does Australia, and has been taking steps to improve its inspection services in recent years. Nevertheless, it has not been able to avoid market complaints (Champ 1977). Even resorting to in-transit fumigation of cargoes has not proven successful (C. Storey, pers. comm.).

Regulation can achieve benefits only where there are adequate resources available, not only in economic resources but also in terms of scientific, technical, and management talent (Chou et al. 1977; Hall 1970). This applies not only to regulation in relation to exports or foodstuffs moving in internal trade but is also illustrated by the operation of plant quarantine services. In those countries which have appropriate quarantine inspection facilities backed up by a trained administration and adequate scientific advice, quarantine risks can be fully assessed and unnecessary barriers to trade avoided. By contrast, and this is not a criticism, those countries with inadequate resources tend to erect barriers without due regard to legitimate risks to domestic production, often by inappropriate adoption of controls from other nations where pest situations are not comparable.

Regulation as a Disincentive

One of the problems facing regulation of the development and adoption of technology is to what extent it can be used to achieve desirable objectives without stifling innovation (Hetman 1977). There is a danger that the inbuilt conservatism of government organisations can act as a disincentive to entrepreneurial activity, particularly that arising from private industry. Snelson (1985) has cited legislative procedures that militate against simple amendments as one of the factors which inhibit the

acceptance of international residue limits for pesticides.

Experience in countries which regulate grain moving in trade, particularly international trade, indicates that an adequate consultative review mechanism, involving industry and sensitive to external changes, is necessary. In Australia, legislative flexibility has been achieved to a degree by the use of the device of Ministerial Orders governing grain exports. By the use of orders, inspection methods and other operational requirements can be modified quickly to meet changing circumstances or to accommodate new technology without the need for recourse to full legislative procedures. Another feature of nations with large regulatory organisations has been a move in recent years to a policy of deregulation and devolution of more responsibilities to industry, often in response to cost-pressure in maintaining regulatory activities, as well as the introduction of charges for inspection services.

Regulation in Developing Countries

Most Australian grain is grown and handled in temperate zones, with a relatively small amount extending into the subtropics. Australian conditions are, however, closer to the tropics than those in other major grain-producing countries in that grain is harvested at temperatures conducive to insect development and, when stored in large bulks, maintains those temperatures over an extended period unless steps are taken to reduce them. In addition, the pest spectrum is essentially the same in the two regions. While scientists in the humid tropics have identified further research and development needed on the suitability of existing control methods for local conditions (Rahim Muda 1985; Sidik et al. 1985), Semple (1985) has stated that appropriate technology for adequate disinfection and long-term storage is known or being developed. Love et al. (1983) pointed out in the context of the situation in Australia at that time, that the insect problem was finite and could be solved using existing technology. While recognising the problems inherent in adopting technology for successful use in the humid tropics, it would appear that answers are generally available. What is needed is national commitment to improving the quality of grain, particularly in circumstances where conditions are changing to longer-term storage and the possibility exists of involvement in export trading in the future.

Conclusions

Regulation should be seen as beneficial where it improves the quality of national grain stocks and facilitates trade. It can be an incentive to

implementation of appropriate standards and controls, as well as a stimulus to further research and development, provided it is administered in a flexible manner and with due regard to the need for review and change. Where these conditions are satisfied, regulation can be considered as an integral part of pest management. It is recommended that, as a component of the research currently being undertaken into postharvest grain handling in the humid tropics, studies should be included to determine whether conditions exist whereby benefits are likely to accrue from introduction of appropriate regulation of standards relating to factors such as infestation control and grade and quality parameters.

References

- Bailey, S.W. 1981. The choice of appropriate storage systems. In: Champ, B.R., and Highley, E., ed. Grain storage research and its application in Australia. Canberra, CSIRO Division of Entomology, 204-206.
- Champ, B.R. 1977. Grain storage and its pest problems in the USSR. *Bulk Wheat*, 11, 57-60.
1979. Factors influencing usage of chemicals in grain storage in Australia. In: Champ, B.R., and Highley, E., ed., Grain storage research and its application in Australia. Canberra, CSIRO Division of Entomology, 151-156.
- Chou, M., Harman, D.P., Jr., Khan, H., and Wittwer, S.H. 1977. *World food prospects and agricultural potential*. New York, Praeger.
- Crosson, P.R. 1975. Institutional obstacles to expansion of world food production. In: Abelson, P.H., ed., *Food: politics, economics, nutrition and research*. Washington, American Association for Advancement of Science, 202 p.
- Hall, D.W. 1970. *Handling and storage of food grains in tropical and subtropical areas*. Rome, FAO, 350p.
- Hetman, P. 1977. *Society and the assessment of technology*. Paris, OECD, 420 p.
- Love, G. 1983. The production, marketing, storage and transport of grain within Australia. In: Champ, B.R., and Highley, E., ed., *Proceedings of the Australian development assistance course on the preservation of stored cereals, 1981*. Canberra, CSIRO Division of Entomology, 7-18.
- Love, G., Twyford-Jones, P., and Woolcock, I. 1983. An economic evaluation of alternative grain insect control measures. Canberra, Bureau of Agricultural Economics, 113 p.
- Rahim Muda, A. 1985. Pest problems and the use of pesticides in grain storage in Malaysia. In: Champ B.R., and Highley, E., ed. *Pesticides and humid tropical grain storage systems: proceedings of an international seminar, Kuala Lumpur, Malaysia, 9-11 October 1985*. Canberra, ACIAR Proceedings No. 14, 11-16.
- Semple, R.L. 1985. Problems relating to pest control and use of pesticides in grain storage: the current situation in ASEAN and future requirements. In: Champ, B.R., and Highley, E., ed. *Pesticides and humid tropical grain*

- storage systems: proceedings of an international seminar, Kuala Lumpur, Malaysia, 9-11 October 1985. Canberra, ACIAR Proceedings No. 14, 45-75.
- Sidik, M., Halid, H., and Pranata, R.I. 1985. Pest problems and the use of pesticides in grain storage in Indonesia. In: Champ, B.R., and Highley, E., ed. Pesticides and humid tropical grain storage systems: proceedings of an international seminar. Kuala Lumpur, Malaysia, 9-11 October 1985. Canberra, ACIAR Proceedings No. 14, 37-43.
- Snelson, J.T. 1985. Regulatory requirements for pesticide use. In: Champ, B.R., and Highley, E., ed. Pesticides and humid tropical grain storage systems: proceedings of an international seminar, Kuala Lumpur, Malaysia, 9-11 October 1985. Canberra, ACIAR Proceedings No. 14, 101-120.

Rates of Technological Change Session Chairman's Summary

Mohd Ghazali Mohayidin *

THE theme of this session was the important topic of rate of technological change. The three papers complemented each other very well. The first paper by Professor R.K. Lindner provided an excellent exposition on the state of the art in research on the process of adoption and diffusion of technology. Dr Brian Fegan then took the participants of the seminar to the real world experience in the Philippines and some other ASEAN countries, while Mr W. Horrigan shared the experiences of the Australian export wheat industry in technological adoption.

The topic of technological change vis-à-vis adoption and diffusion of technology has been discussed in the literature for more than 50 years. As the economy develops, the problems involved in the process become more and more complex and research methodologies in this area have become increasingly sophisticated, particularly when the conditions of risk and uncertainty are taken into consideration.

Professor Lindner characterised the adoption and diffusion processes as a sequence of risky choices. The potential adopter knows little about an innovation and, by a learning process, gathers more and more information until finally either adopting or rejecting the innovation.

In his paper, Professor Lindner also presented a review of some empirical studies in the area of technological adoption and diffusion. He categorises the studies into two types: firstly, cross-sectional, which deal with the actual adoption or rejection of an innovation; and secondly, temporal, which deal with the time lag in the adoption and diffusion process. Most of these studies, however, are distinguished by a generally low overall explanatory power or mutually contradictory findings, mainly due to the conceptual failure by most authors to appreciate the importance of the dynamic learning process involved.

Professor Lindner believes that the methodology developed by Griliches (1957) represents a breakthrough in this area of study.

In discussing the findings of various studies, Professor Lindner finds compelling empirical support for the idea that the final decision to adopt or reject an innovation is consistent with the producer's self-interest. Constraints to the learning process slow down the rate of diffusion, but are not in themselves obstacles to the ultimate adoption of innovation.

Professor Lindner concluded his paper by saying that technology design is more important than technology transfer.

Dr Brian Fegan's paper on political and social constraints to rate of change in grain handling technology in the humid tropics looks into the real-world experience of technology adoption in the Philippines. He believes that the intervention of the government in the markets for factors of production and products is for political reasons. This is considered by him as a major constraint to the full utilisation of new

* Faculty of Resource Economics and Agri-Business, Universiti Pertanian Malaysia, Serdang, Selangor.

technology. In order to get farmers' votes, this policy causes the state large capital costs, subsidies, and losses of grain quantity and quality.

Dr Fegan believes that market-oriented farmers, traders, storers, transporters, and millers will only use new technology if the benefits derived from its adoption exceed the cost of adoption. The utilisation of grain dryers is given as an example. Low annual throughputs and organisational problems put the capital cost of dryers beyond the reach of the small farmers. They are more likely to be adopted by traders with sufficient capital to buy grain from a wider area, particularly those with integrated trading, storage, and milling facilities.

In the area of bulk handling, Dr Fegan feels that it is appropriate only to isolated surplus-producing areas with large farms, a monopoly grain buyer, and a distant urban or international market.

To facilitate the process of technology adoption, Dr Fegan suggests that the government look at the system as a whole and provide incentives for quality production along a string linking all participants in postharvest activities. The strength of the pull on the string is the size of the price differential consumers are ready to pay between high- and low-quality rice.

In the third paper of the session, Mr W. Horrigan shared with the participants of the seminar the Australian experience on how regulation acts as a stimulus for the adoption of technology to improve quality of wheat for export. He cautioned the participants, however, that regulation may hinder the process of technology adoption if government organisations are too conservative. Legislative flexibility is often necessary.

Several issues were raised by seminar participants during the discussion session, including the following:

1. Profitability is perhaps the most important determinant of technology adoption and the rate of technology diffusion. However, other factors such as the presence of non-market inputs like family labour also have some influence on the process.

2. The role of extension services in the process of technology adoption and diffusion is pointed out as an important factor. Improvement in the quality of these services is suggested.

3. The extent of government intervention is questioned. There is no easy answer to this since it is highly dependent on the political situation of each country.

Case Studies

The BULOG Experience in Storage Management and Quality Maintenance

Mulyo Sidik *

Abstract

Among the important factors contributing to BULOG's success in overcoming postharvest problems in Indonesia are improvements in storage management and the quality maintenance system. Construction of new grain complexes since 1975 has increased storage capacity to about 3.5 million tonnes. An integrated pest management program, combining physical and chemical methods, was introduced in 1979.

New methods for maintaining the quality of rice during storage have also been implemented. Quality control during procurement has been tightened, and routine monitoring and evaluation of stored food commodities is practised. Controlled atmosphere storage systems, involving the introduction of carbon dioxide to sealed plastic enclosures containing bag stacks or using the gas to purge small packages, have also been tested as part of efforts to reduce quality deterioration in rice during storage. A method of storage in which one tonne lots of rice are stored under vacuum in plastic containers has given good protection from insect pests over at least a two-year period.

Further improvements in storage technology are being investigated, including the use of carbon dioxide mixtures with insecticide for prevention of insect reinfestation of stored rice. Improvements are also being sought to reporting and recording systems, in order to get accurate, up-to-date data on rice quality throughout the country. In all its efforts to improve long-term storage capability, BULOG is seeking methods that are economically as well as technically feasible.

INDONESIA'S attainment of rice self-sufficiency in 1984, after long being one of the world's largest importers of rice, had a great impact on the agricultural development of the country. This remarkable achievement was the result of not only an accelerated rate of increase in rice production but also a greater capacity to ensure adequate supplies of rice (as a primary staple food) at relatively stable prices for most of its growing population. Major strides have been made in strengthening national food security, through the maintenance of national reserve stocks stored in thousands of storages spread throughout the Indonesian archipelago.

This progress, however, has also brought problems and challenges, especially to the National Logistics Agency (BULOG). The amount of rice which has to be procured and stored by BULOG has progressively increased. In 1984-85, BULOG

recorded its highest purchases of rice (2.374 Mt) since the Third Five Year Development Plan (Repelita III) was launched in 1969. A smaller amount was procured in 1985-86 (1.943 Mt), but this was still substantially larger than the annual purchases during Repelita III (Fig. 1).

During the same period, the market operation (to stabilise the price of rice in the market) happened to be very small, whereas the average annual market operation during Repelita III had amounted to more than 1.3 Mt (Table 1) (Anon. 1986).

These circumstances have caused a massive accumulation of stocks in BULOG's storages. Furthermore, pressing problems and critical situations seemed to be unavoidable, contributing not only to rapid quality deterioration due to the extended storage period (more than one year), but also to the financial burden borne by BULOG.

It is quite obvious that raising production rates without taking corresponding steps to safeguard the product can result in postharvest problems which outweigh the benefits of higher production.

* National Logistics Agency (BULOG), Jalan Gatot Subroto 49, Jakarta, Indonesia.

The risk of decreasing quality was further increased by the effects of excessive rain during the months of peak harvest. Inability of farmers to meet the quality standard imposed by the government during that time has also contributed difficulties in maintaining quality of stored grain.

There is no doubt that, in such circumstances, storage management and quality maintenance play important roles. Improvements in both aspects have been carried out by BULOG in an endeavour to maximise the benefits of increased production and ensure that they are not nullified by inadequate postharvest practices.

The results so far have been quite promising: quantity and quality losses have been markedly reduced and grain can be stored for a longer period with minimum deterioration. It is BULOG's intention to further improve the system, so that losses can be pushed down as far as possible. In this regard collaboration with other research institutions is essential in order to accelerate the process of achieving that goal.

Problems in Storage Management and Quality Maintenance

Since the 1960s, BULOG has been the sole government agency handling stock in order to stabilise the price of rice and other basic commodities. It has implemented a buffer stock policy.

To perform its function, BULOG must have a certain amount of stock available and ready to be distributed at any time. According to Falcon et al. (1985), this minimum stock is 1.5 Mt. The larger the stock BULOG has, the greater will be the burden on the agency, mainly due to the capital cost, storage costs, and other costs related to maintaining the quality of grain. However, it is government intention that the national reserve stock reach at least 5 Mt.

The amount of stock in BULOG's storages has increased almost every year over the past 8 years (Table 2) and it appears that this is directly related to the increasing total rice production since 1978. There is no doubt that such a situation is good for the people, since they can obtain rice easily at relatively low prices. This success, however, has also brought problems to BULOG, especially in terms of storage management and quality maintenance.

Insufficient Storage Space

In the early 1960s, most BULOG storages were rented from private traders. Storage conditions were

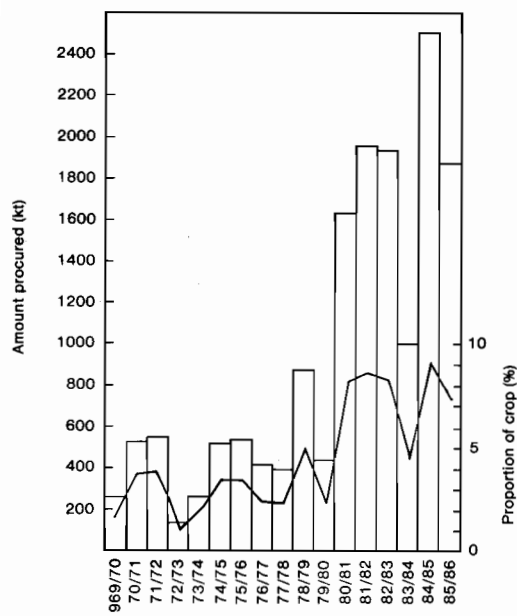

Fig. 1. Quantities and total harvest proportions of rice procured by BULOG, 1979-80 to 1985-86.

TABLE 1. BULOG's domestic procurement and stock releases (distribution and market operation) of rice during Repelita^a I (1969-73), II (1974-78), and III (1979-83), and the first two years of Repelita IV. Values are thousand tonnes and for Repelita I-III are annual averages.

Period	Domestic procurement	Releases			Balance	
		Distribution	Market operation	Other ^b		
Repelita I	349	790	364	55	1209	- 860
Repelita II	554	749	984	96	1829	- 1275
Repelita III	1421	1019	1332	58	2409	- 988
1984-85 ^c	2374	1427	69	106	1602	+ 772
1985-86 ^d	1943	1483	383	449	2315	- 372

^aFive-year development plan.

^bOther domestic releases.

^cRevised.

^dProvisional.

TABLE 2. BULOG's operations under the price stabilisation program for rice during Repelita^a I (1969-73), II (1974-78), and III (1974-78), and the first two years of Repelita IV. Values are thousand tonnes.

Component	Repelita I (annual average)	Repelita II (annual average)	Repelita III (annual average)	Repelita IV	
				1984-85 ^b	1985-86 ^c
Opening Stock	317	555	1058	1442	2391
Procurement:					
Domestic	349	554	1421	2374	1943
Import	913	1389	1170	187	-
Subtotal	1262	1943	2591	2561	1943
Total supplies	1579	2498	3649	4003	4334
Releases:					
Budget group & state enterprises	790	749	1019	1427	1483
Market operations	364	984	1332	69	383
Other releases	55	96	58	106 ^d	449 ^d
Total	1209	1829	2409	1602	2315
Losses & waste	42	51	35	10	23
Closing stock	328	625	1205	2391	1996

^aFive-year development plan.

^bRevised.

^cProvisional.

^dIncludes exports.

far from meeting the standards for storing food. It was commonly found that poor storages located very close to rice mills had to be rented, since BULOG was put into a position where the rice had to be stored somewhere. In these circumstances, sanitation and good storage practices were practically impossible to implement. Moreover, it seems likely the storage managers were unclear about the important roles played by sanitation and storage management in maintenance of grain quality.

Poor Storage Practices

As noted in the preceding section, conditions in most of the storages were bad. Sanitation was inadequate and this contributed to a rapid decrease in grain quality.

Rice in Indonesia is stored primarily in milled form, which is prone to insect infestation. It was commonly found, however, that rice was stacked on poor pallets or dunnage, and sometimes even without pallets. Direct placement of bags caused an uneven ventilation in the stack, thereby fostering moisture migration and other storage problems, all of which brought about acceleration of grain deterioration.

Old jute bags, and old or unused pallets were stored close to the rice stacks. These items were potential sources of insects for infestation of new stocks of rice brought into the store.

Pest control measures, either fumigation or spraying, were rarely practised. Even to carry out such measures would be difficult because of improper stacking that made sheeting difficult.

Moreover, improper stacking resulted in inadequate inventory, monitoring, and evaluation of grain quality.

Insufficient Trained Staff

As indicated earlier, very little attention had been focused on storage management, especially good storage practices such as pest control, which are acknowledged as important in maintaining grain quality during storage. The situation was further aggravated by lack of a sufficient number of skilled and trained staff. Most rented storages were managed by their owners, who rarely received any training. They barely understood the problems caused by pests in storage, and suffered from a lack of information on pest biology, ecology, and the factors contributing to deterioration of stored grain.

The prevention and control of pest infestation in storage were carried out mainly by private pest control companies, with minimal supervision by BULOG, primarily due to lack of trained staff. Improper sealing during fumigation and under-dosage of insecticides have been common. As a result, insect infestation was a major factor contributing to storage losses. The development of insect resistance to insecticides was probably hastened. Pesticide resistance was reported by Haines and Pranata (1982) after they conducted a survey in several storages in Java.

All of the above conditions accelerated the deterioration process of stored grain, and losses during storage were relatively high (3-5% per year).

Knowing the above, BULOG's management decided to take steps to overcome the problem.

Efforts to Improve Store Management

Lack of storage space was one of the depressing factors that BULOG had to face in the past. To overcome this problem, BULOG with government support began a program in 1975 to construct new storages throughout the country.

A standard godown of 3500 t capacity per unit, built from concrete and steel, began to be constructed. Many factors were taken into account in designing the new godown. They included insect and rodent control, sanitation, and other basic requirements of food storages.

Each unit is also equipped with sufficient pallets or dunnage to support the stacking, with water, a fire extinguisher, and a vacuum cleaner, and with access to a road, so that loading and unloading can be conducted without problems.

Besides constructing new storage complexes, godowns rented from private companies are still needed, particularly during the peak procurement season. These private godowns are selected carefully and have to meet BULOG standards. Total storage capacity used by BULOG continues to increase and in 1986 stood at more than 5 Mt (Table 3).

As a part of storage management improvement, the 'dynamic FIFO' (first-in, first-out) policy is more strictly adhered to, so that there will always be relatively fresh stocks in storage. The stacking system has also been improved. Stacks are built to maximise utilisation of space without jeopardising adequate ventilation throughout the godown.

The number of units per storage complex varies from place to place, but ranges from 1 to 40 per complex. An office, separate from the godown but within the complex, is also built as a place to conduct all administrative work, including that of the storage manager. It is important to ensure that administrative tasks are done properly and safely, away from daily activities in the storage.

Training for both storage managers and pest control operators is also carried out, to support the physical improvement of storages. This is crucial, since without capable personnel all improvements

to physical aspects would be wasted.

Besides the above-mentioned measures, BULOG has, with full government support, made significant changes to aspects of procurement, especially in terms of standards, grading, and pricing policy.

Although quality standards for rice and other basic commodities have been imposed in the past, they were, for several reasons, frequently changed. It was quite common for rice with a milling degree slightly lower than standard, or percentage of broken and yellow kernels higher than stipulated, to be accepted. These actions, however, were very costly for BULOG. Quality deterioration occurred rapidly, weight losses were excessive, and many criticisms and complaints were made by fixed income earners (budget groups) who received rice routinely from BULOG.

Over the last three years, BULOG has openly re-emphasised that it will no longer accept rice which does not meet its standard. To support this decision, BULOG has helped village unit cooperatives (KUDs) obtain postharvest equipment such as mechanical dryers, credit to improve rice mill units, cement to lay new drying floors, etc. Postharvest technology training courses are offered to private millers and cooperatives to increase their knowledge and ability to improve the quality of rice produced. The impact of these actions has been quite remarkable. The rice bought by BULOG in 1985-86 procurement season was much improved over previous years.

Improvement in physical aspect is also followed by more encouraging price of the commodities produced. Beginning in 1986, BULOG decided to provide a greater incentive to farmers who are able to meet its quality standard. An incentive payment of Rp 4/kg (approx. US\$4/t) is intended to cover 'drying cost' especially during wet season.

Although the floor price of rice is still Rp 175/kg, there are four price categories covering rice with different moisture contents. For rice with 24% moisture the price is Rp 105/kg, while rice at 18% moisture content receives Rp 125/kg. For rice with

TABLE 3. Total storage facilities used by BULOG in 1985-86.

Category of storage	January 1985		January 1986		Increase (%)	
	No. of units	Capacity (t)	No. of units	Capacity (t)	No. of units	Capacity
Government:						
New godowns	602	2 134 050	664	2 387 550	10.3	11.9
DOLOG ^a	531	614 850	591	703 230	11.3	14.4
Subtotal	1133	2 748 900	1255	3 090 780	10.8	12.4
Private	797	1 896 490	887	2 574 220	11.3	35.7
Total	1930	4 645 390	2142	5 665 000	11.0	21.9

^aIncludes semi-permanent type storages.

16 and 14% moisture content the prices are Rp 150 and Rp 175/kg, respectively. This system is relatively easy to follow, and it is hoped that farmers will more readily understand why they receive a particular price for their rice.

Another significant step being taken by BULOG to improve quality maintenance of rice during storage, is the establishment of laboratories to check the quality of rice during procurement and to monitor and evaluate its quality during storage. These laboratories have the equipment and staff to make accurate and independent quality determinations. For the first phase, 21 storage complexes in the main rice production areas (Java and South Sulawesi) have been provided with such laboratories.

Pest control measures play an important role in the improvement of quality maintenance during storage. Previously, only routine spraying and fumigation were considered as important in pest control (Sidik et al. 1985). Beginning in 1984, new techniques have been applied, such as permanent sheeting of stacks followed by aeration, use of carbon dioxide in large stacks and small packages (5 kg) and, more recently, storage of rice under vacuum in plastic containers.

The latest technique for prevention of insect infestation now being tested is the use of a carbon dioxide/insecticide mixture as an alternative to existing spraying systems. A semi-automatic device installed in the godown produces insecticide vapour. Carbon dioxide in liquid form acts as a solvent for the insecticide which will disperse uniformly when the device is switched on. It is expected that if this system proves to be technically and economically feasible it could be implemented in most of the storage complexes throughout the country. As a commercially orientated organisation, BULOG always carefully verifies new methods of pest control before they are widely implemented. Cost effectiveness is one of the determinants for selecting such technologies.

Major steps are also taken in reporting and recording systems, to get an up-to-date picture of stocks throughout Indonesia. Since 1972, FAO has been helping BULOG to develop a Management Information System (MIS). This system is considered a very important tool in decision making by BULOG's top management. With this system, the latest change in quantity of stock in almost every godown can now be followed quite easily. Monitoring the quality of grain in storage, and movement/shipment of stock from one Dolog to another, are also covered in this system.

All of the above steps are carried out under the umbrella of an Integrated Storage Pest Management (ISPM) program, in which all elements in the

postharvest chain are linked together. Viewing all elements as an integral part of ISPM gives a more realistic picture than considering each element in isolation.

BULOG's major changes to storage management practices since the 1970s have improved the overall condition of stored commodities. Rice can now be stored for relatively longer periods (more than one year) with only minor quantity and quality losses. The reductions in weight losses during storage have been quite significant. They are now estimated to be 0-0.3% for 12 months storage.

Research and Development Needs

Although there has been much progress, there is no doubt that further improvements are needed. New methods of controlling insect infestation have to be pursued, in order to arrest the grain deterioration process with minimal negative effects to the grain itself and to other organisms and the environment.

Many more storages with better conditions are needed to meet the demand for good storage space since rice production is expected to increase constantly although at a slower rate than currently. BULOG's stocks are also expected to increase, in line with the increasing marketable surplus and the demand for rice at reasonable prices throughout the country.

Recent findings have indicated that, unless there is a technological breakthrough in rice production, the rate of growth in rice production in Indonesia will not be as great as before. However, consumption is expected to increase at least at the same rate as population growth (approx. 2.3-2.5% per annum) (Abdul Adjid 1986). This makes efforts to minimise losses in the postproduction system, including storage, even more important.

In the effort to minimise losses in the post-production system, collaboration between the various postharvest agencies and institutions is essential. It will accelerate progress and minimise duplication of effort. In the situation where funds are limited, it is always wise to work together in order to overcome shared problems.

Research on bag storage systems has received less attention than bulk storage. Moisture migration in bag storage and other environmental changes occurring inside stacks in the humid tropics, are among the important aspects that need to be studied.

Development of new techniques for preventing insect and mould infestations, which contribute to grain deterioration, should be vigorously pursued.

It has to be remembered, however, that work on storage and handling systems cannot be separated

from other agricultural development since these systems are an integral part of the agricultural production process (Semple 1986).

References

- Abdul Adjid, D. 1986. Agricultural development strategy to secure the food self-sufficiency approaching the year of 2000. Jakarta (unpublished), 68 p.
- Anon. 1986. Food/rice price stabilisation in Indonesia. An annual report 1985/1986. Jakarta, BULOG, 35 p.
- Falcon, N.P., Mears, L.A., Timmer, C.P., Hastings, M.M., and Pearson, S.R. 1985. Rice policy in Indonesia, 1985-1990. The problems of success. Jakarta, BULOG, 33 p.
- Haines, C.P., and Pranata, R.I. 1982. Survey on insects and arachnids associated with stored products in some parts of Java. Presented at 1982 Grains Post-Harvest Workshop, Chiangmai, Thailand. Manila, Southeast Asia Cooperative Post-Harvest Research and Development Programme, 17-48.
- Semple, R.L. 1986. Problems relating to pest control and use of pesticides in grain storage: the current situation in ASEAN and future requirements. In: Champ, B.R., and Highley, E., ed. Pesticides and humid tropical grain storage systems: proceedings of an international seminar, Manila, Philippines, 27-30 May 1985. Canberra, ACIAR Proceedings No. 14, 45-75.
- Sidik, M., Halid, H., and Pranata, R.I. 1985. Pest problems and the use of pesticides in grain storage in Indonesia. In: Champ, B.R., and Highley, E., ed. Pesticides and humid tropical grain storage systems: proceedings of an international seminar, Manila, Philippines, 27-30 May 1985. Canberra, ACIAR Proceedings No. 14, 37-43.

Application of Grain Dryers at Farm Level

Gloria D. Picar and Angelita G. Cardino *

Abstract

The greatest problem confronting the Philippine's grain postharvest industry is the significant losses and quality deterioration that occur due to the inability to reduce the high moisture in freshly harvested grains at a rate fast enough to arrest spoilage. The difficulty becomes more severe during the main season crop harvested in the rainy months of the year, when sun drying is not practicable. However, despite the availability of several mechanical drying technologies and the obvious need for such facilities, the private sector has been quite reluctant to use mechanical dryers.

This paper reviews the results of research carried out to investigate the problem and discusses the causes identified for the low adoption of mechanical dryers in the country. An analysis of the various factors present in the marketing system that contribute to the resistance to mechanical dryer use is also made.

In order to define the requirements for use of mechanical dryers, case studies of their successful application are presented. Specific recommendations, based on the case studies and earlier survey work, are put forward to overcome constraints to use of dryers. Implications for current government policies on pricing and grading are given. Finally, recommendations for future directions of grain storage research and development, as well as immediate needs for training and extension, are presented.

IMPROVED grain production technology and management have resulted in dramatic increases in yields of paddy in the Philippines, from the traditional 1.5 t/ha to 3-5 t/ha (BAE 1983). However, this development also underscored the inadequacy of current postharvest practices and infrastructure capability.

Significant grain losses, estimated at 2-23% by Paz and Cabacungan (1986), occurred in the subsequent chain of on-farm operations after the produce was harvested. Essential to the preservation of the harvested crop is the reduction of its moisture content at a rate fast enough to arrest spoilage and to a level safe for storage.

In the Philippines, sun drying is the most widely practised means of accomplishing this. During the dry season, grain drying is not a large problem. The difficulty arises during the main season crop harvested in the rainy months of the year, i.e.

September to November, when sun drying cannot be done effectively. The study by Mendoza and Quitco (1984) revealed that threshed, high moisture paddy which was subjected to 5 days delay in drying exhibited 17% yellow grains.

Thus, during wet season, farmers generally sell their harvest immediately, usually at a lower price. The situation is made worse by the reluctance of millers/traders to purchase wet paddy because of the risk of grain spoilage.

Since mechanical drying is the only alternative when sun drying is not possible, its use has been vigorously promoted by the government. Several types of mechanical dryers are available locally, (Frio and Manilay 1984), namely:

1. The UPLB 2-t batch dryer. Variations are the IRRI version, the Thai Agricultural Engineering Division model, the LPN 30-t model, and the BULOG/ITB (Indonesia) version.
2. The LSU continuous-flow model with tempering bins with drying capacity of 1 to 5 t/hour.
3. The Danish Kongskilde vertical batch type dryer.
4. The Japanese batch type grain recirculating model.

* National Postharvest Institute for Research and Extension, Central Luzon State University Compound, Munoz, Nueva Ecija, Philippines.

5. The farm type AIT solar dryer using chimney-induced draft.
6. The vortex wind pump for barn drying application, developed by Dr Jeon (Korea/IRRI).
7. The African (KSU-Brooks) pit dryer.

However, despite the availability of these alternative grain-drying technologies and the obvious need for such facilities, the private sector has been quite hesitant to purchase or use mechanical dryers. Currently, the total number of mechanical dryers in the country can process only 12% of total paddy production and 90% of them are owned by the government. Considering that the government handles a maximum of only 10% of production, mechanical drying capacity is notably lacking in the private sector.

Constraints to the Use of Mechanical Dryers

In an attempt to increase the use of mechanical dryers in the country, several studies have been conducted to investigate the factors contributing to their low adoption. Alviar et al. (1981) studied the application of mechanical dryers and other available agricultural engineering technologies in rice production. Lorenzana et al. (1981) investigated the on-farm postharvest practices and problems in Isabela, including the lack of interest in mechanical dryers despite the recognition of the difficulties involved in sun drying. Sison et al. (1983) also evaluated the social acceptance of machines designed by the University of the Philippines at Los Baños (UPLB) including the 2-t flat bed dryer. Similarly, the International Rice Research Institute (IRRI) has conducted studies on the factors affecting mechanisation of farm level rice postproduction systems (Duff and Toquero 1975). On the other hand, a study conducted by the National Postharvest Institute for Research and Extension (NAPHIRE) focused solely on problems of low-adoption/utilisation of mechanical dryers and how these could be overcome (Cardino 1985).

The abovementioned studies revealed that constraints to the use of mechanical dryers were mainly socioeconomic or to do with operational difficulties encountered during usage. Much of the discussion in this paper will be based on the results of the study conducted by NAPHIRE, unless otherwise stated.

In summary, these constraints, as perceived by users and non-users, were as follows:

1. High fuel costs and other operating expenses

This was the constraint to dryer use most cited in the studies conducted, both for on-farm and off-farm operations. Fuel comprised a substantial percentage of a dryer's operating cost. Because the rate of price increase for fuel was higher than the

other inputs, mechanical dryers became unprofitable.

Furthermore, the costs and benefits of operating a mechanical dryer were often directly compared with sun drying per se. Since labour was the only major expense for the latter activity, and there was no significant advantage of the mechanically dried paddy over that of sun-dried produce, mechanical dryers were perceived to be unprofitable.

Alviar (1981) also added that besides the costs of fuel and oil, the high cost of repairs and maintenance further hindered utilisation.

Sison et al. (1983) further found that the additional labour input required for mechanical drying was also a major deterrent to its use. Respondents stated that the flat bed dryer took a longer time to dry a smaller volume of produce and thus required a greater labour input.

2. Incompatibility between the capacity of the dryer and the requirements of end-users

The limited capacity of the dryer was another constraint cited by Cardino (1985) and Sison et al. (1983). Delays in drying were experienced by the end-users (mainly farmers' associations and millers), forcing them to resort to partial drying. This situation reflected the improper selection of dryer capacity. The selection of the dryer was mainly based on what was available at the time, without considering the grain flow and volume of paddy handled by the end-users.

A related issue to this is the short period of utilisation during the year. Mechanical dryers are used only during the wet season and lie idle most of the time. Since no benefit is delivered while the dryer is idle, then the recovery of investment is perceived to be slow. Also, it is ironic that the dryer that lies idle most of the year due to the seasonal nature of harvesting and procurement operations, is often found to be inadequate when the need to use it eventually arises.

At the other end of the scale, dryer capacity was observed to be too large with respect to the limited production volume of individual farmers (Lorenzana et al. 1981). Farmers had an average farm size of 2 ha, with an average production of 3.45 t/ha, out of this total produce, about 25% was given to the landlord for land lease, 20% for harvester/thresher fees, 22% for the irrigation fee, and a portion saved for food after paying the loan for production input. Any surplus grain will then be sold. Consequently, only a small volume of paddy is left to the farmers. This can be easily sundried on existing pavements with few additional costs.

3. High investment cost and insufficient capital

Most paddy farmers belong to the low income group whose major source of income is farming.

Thus, at harvest time when cash is usually lacking and the pressure to begin planting activities is felt, on-farm production and postproduction activities compete for the farmers' limited resources (MacCormac 1985). Therefore, income generated is usually spent to meet basic needs and the rest ploughed back into production activities. On-farm activities after harvesting and threshing, particularly drying, were considered optional and thus ranked a low priority in terms of resource allocation.

Similarly, processors with limited capital viewed dryer investment as less important than business expansion through increased procurement or additional mill facilities.

4. Poor product quality and inconvenience in operation

Previous users also complained that mechanically dried paddy was dull in colour and brittle when milled, resulting in lower milling and head rice recoveries (Cardino 1985; Sison et al. 1983). However, poor product quality may not be due solely to technical deficiencies of the dryer. A general lack of proper knowledge and/or poor initial quality of the paddy could be contributing factors. Some operators were observed to increase drying temperatures to speed up the process without appropriate adjustments to the other operating parameters, resulting in uneven drying of the commodity.

Likewise, the inconvenience due to heat and dust encountered while mixing the paddy during drying, cited as a deterrent to mechanical drying, may also reflect a lack of operating skills. Flat bed dryers were designed to dry a static mass of grain and their designers argue that mixing is not necessary.

5. Lack of farmers' groups

With reference to farmers' groups, another important factor that restricted the use of mechanical dryers at the farm level was the lack of strongly organised groups. Mechanical dryer use usually failed due to internal weaknesses and mismanagement.

6. Inadequate extension programs

The surveys from the cited studies also revealed that, despite the government's aggressive program to encourage mechanical drying, many claimed that they have never seen a mechanical dryer. This suggests that current extension programs to promote the use of mechanical dryers are inadequate or ineffective.

Market Factors Affecting the Adoption of Mechanical Dryers

Aside from the various constraints that directly affected the use of mechanical dryers, various other aspects of the grain marketing system also influenced their adoption.

1. Presence of a market for wet paddy

Farmers usually dispose of paddy straight after threshing because of an immediate need for cash. This decision is made even easier during the wet season when the risk of grain deterioration is high. In addition, since local traders, millers, and even the National Food Authority (NFA) buy paddy with moisture contents above 14%, there is no inducement to farmers to dry their produce. Furthermore, traditional working relationships exist between the traders/millers and farmers, with the former supplying production capital for the latter (Sison et al. 1983). Thus, the farmer's produce is already committed, even before the harvest, with the price usually set by the buyer. This is a further disincentive to the farmer to improve the condition of his grain. In addition, some millers procure more stocks during the wet season because of lower prices then, compared with the dry season.

2. Lack of incentives to dry

The NFA provides a premium of only US \$0.0015/kg to farmers who deliver clean and dried paddy. This is not sufficient incentive to encourage the use of mechanical dryers. A study by Toquero and Duff (1976) showed that, in spite of price and weight differentials in the grain pricing structure, farmers still claimed that, since wet paddy is heavier, the mark-up in the price was not enough to compensate for the trouble and money incurred in drying.

Data obtained by NAPHIRE revealed that the average price paid by private traders for dried paddy during the wet season was US \$0.0770/kg and for wet paddy US \$0.0545/kg. Assuming that 5 kg are deducted from every bag (50 kg) of wet paddy and the cost of drying as obtained by NFA (Mangaoang 1984) was US \$11.00/t the net income recovered by a farmer who sold his stocks dried was only higher by US\$0.45/bag. Considering the risks involved, the time, money, and effort expended, and the delay in cashing their stocks, farmers considered the benefits accruing from mechanical dryer to be inadequate.

3. Inapplicable grading system

Duff and Toquero (1975) note that the lack of suitable grades and standards and the proper institutional organisation to enforce them is also a serious shortcoming.

In general, grading standards set by the government are not followed in the local market because of their inapplicability under field conditions. Instead, a subjective grading system based on the buyer's judgment and perceptions is practised.

In the Philippines, two major factors influence the price of paddy, namely the variety and visual appearance of the grain. Due to the absence of mechanical moisture testers, grain moisture contents

are also determined by the feel and sound of the grain. This situation has discouraged farmers from producing good quality grain, since the price obtained does not reflect the true value of the grain based on its quality.

4. Existence of a market for low quality milled rice

Most consumers in the Philippines are not particularly discriminating in their demand for rice. Price, variety, and whiteness are the main factors considered by buyers with price the major one. Quality indices such as broken rice, presence of stones and paddy, etc. are relatively insignificant. Consequently, low quality milled rice is accepted in the local market, especially if its price is within the reach of the majority.

IRRI reported that an increase of 14% in brokens decreased the wholesale price of milled rice by only 9%, in sharp contrast to 32% in Thailand for the same drop in quality (Frio and Manilay 1985). Clearly, the market does not adequately reward the production of good quality milled rice. Mears et al. (1974) stated that expensive mechanical dryers cannot be justified by the domestic premiums paid in the domestic market for the resulting improved rice.

Factors Contributing to the Continued Use of Mechanical Dryers

Despite the perceived disadvantages inhibiting the use of mechanical dryers, there were some advantages observed by their users:

1. They are able to prevent grain spoilage, particularly during times of continuous rain. This reduces the risk of product loss and provides an opportunity to receive better prices (Cardino 1985; Sison et al. 1985).
2. Grain buyers are able to increase their procurement, especially during the wet cropping season. This is particularly advantageous since, during this period, for fear of grain spoilage, there are many farmers willing to sell but few buyers.
3. Grain processors are able to increase/optimize their milling operations due to the ability to purchase more stocks.
4. Grain processors incur less spillage and lower labour requirements in their handling operations.
5. Farmers' associations are able to provide better services to their members.

Requirements for the Successful Use of Mechanical Dryers

Case studies conducted by NAPHIRE on four existing users further clarified the conditions and factors necessary for the successful use of

mechanical dryers. The cases are described in an annex to this paper.

The requirements for successful use are as follows:

1. Large volume of paddy to achieve economies of scale

The value of paddy saved from deterioration and higher income realised from better quality grains through mechanical drying may be sufficient to cover the costs of operating a dryer if large volumes of marketable paddy are processed. Also, the volumes should be sufficient to allow a significant increase in profits to offset any opportunity costs. Roger and Shoemaker (1973), as cited by Frio et al. (1985), argue that technology adoption occurs only when adopters perceive at least a 30% increase in income from the use of the technology.

2. Integration of mechanical drying with other postharvest operations to enhance mechanical drying benefits

Drying is just one of a whole series of operations applied to the crop from planting to eventual marketing. The effective use of a dryer depends on its smooth integration with these other operations and conditions that surround the drying operation. Thus, the profitability of a mechanical dryer is more accurately evaluated in terms of its subsequent impact on the other operations. For example, as regards milling, the benefits of mechanical drying are:

- (a) the better quality milled rice resulting from the ability to adequately dry stocks in spite of inclement weather; and
- (b) increased or optimal milling operations due to the opportunity to purchase more paddy in the wet season.

The African pit dryers modified by Siliman University and reported (ASEAN Crops Postharvest Programme, pers. comm. 1984) to be increasingly adopted by maize farmers in the central Philippines, filled a critical need arising from the marketing inefficiencies of the province. Because of high precipitation, lack of buyers in the area, and an inadequate road/transportation system, farmers had no recourse but to mechanically dry their crop or face the consequences of substantial or total grain losses.

3. Critical selection of dryer to ensure compatibility with the system's drying load

Dryer efficiency should be evaluated in terms of meeting the drying requirements of the system and not just technical performance. Thus, volume requirement and material flow through the system, as affected by institutional structure and management practices, should be considered in determining drying capacity.

4. Sufficient technical knowledge/skills in operating a mechanical dryer to maintain its performance

The operator of the mechanical dryer should be adequately trained to prevent technical problems and unnecessary inconveniences during its operation. Difficulties encountered in mechanical drying and poor product quality have often been blamed on the dryer when lack of operating skills could have been the cause.

Recommendations

In summary, the unprofitability and lack of technical knowledge in operating a dryer are the identified root causes underlying the expressed constraints in the use of mechanical dryers. In order to overcome these, the following recommendations are put forward:

1. Since individual farmers, due to their generally poor economic condition, cannot afford to invest in or use mechanical dryers, farmers' groups or associations should be tapped to undertake mechanical drying at the farm level. Their pooled resources and aggregate production volume could provide the economies of scale needed to make mechanical drying feasible. They may also have sufficient training and the management and business skills required to operate dryers.

2. Similarly, large commercial farmers and private millers/traders are sectors that could be targeted as potential investors and users of mechanical dryers because of the larger volumes of grain handled and resources available.

3. In some exceptional cases where marketing inefficiencies exist and the farmer regularly faces the prospect of losing much or all of his crop, indigenous designs using alternative fuel sources, like the African pit dryer, could be introduced and promoted. However, the promotion of these types of dryers should be restricted to situations where the pressure to dry is directly experienced by the farmers themselves.

4. To maximise the benefits derived from mechanical dryers, they should be integrated as a support facility to milling and marketing activities. Thus, direct benefits such as prevention of paddy losses in terms of quantity and quality are augmented by the additional income generated from better quality milled rice and increased business volume due to the greater capability to procure stocks in the wet season. Essential to this is a practical and workable drying scheme involving both mechanical drying and sun drying, which should be devised to dovetail with existing business practices and operations.

5. Assistance in the determination of the drying requirements of the end-user's operation should be provided, possibly by government or by private firms dealing in mechanical dryers, in order to select dryers suited to needs. De Padua (1985) reported that in almost all cases, even in plants set up by business corporations, no realistic analysis of drying needs in relation to the raw material supply and the plant's downstream requirements have been made. Thus, technical services to meet this specific need of the private sector should be incorporated in the overall extension program to promote the use of mechanical dryers.

6. In general, drying should be studied and analysed as part of the total marketing system. Cost-benefit evaluation of mechanical drying done on a unit operation basis will not accurately reflect its advantages. Since drying is a prerequisite for the subsequent operations of milling, storage, and distribution, its impact on these postharvest activities must be taken into consideration.

7. A practical grading system appropriate to farm-level use and providing a more rational basis for trading/marketing practices needs to be developed and enforced. Also, a responsive pricing structure incorporating quality grading factors is essential to encourage farmers to produce good quality grain. Price differentials for wet and dried grain should be high enough to offset the additional costs and time involved in mechanical drying.

8. Extensive training and extension services to help prospective users of, or investors in mechanical dryers to understand the principles involved in mechanical drying and make them aware of the benefits derived, should likewise be immediately conducted. A concept similar to the demonstration farms that are established to demonstrate the benefits of production technologies, could be adopted for the postproduction sector. For example, setting up mechanical dryers in selected strategic locations in the country, within the context of an integrated village postharvest centre, could be used to demonstrate the quality of grain obtained from mechanical drying.

9. Finally, the following areas for future activities in grain drying research and development are also recommended:

(a) In view of the unsuccessful attempts in the past to use farmers associations/groups as vehicles for community development, a vigorous analysis of the situation and definition of the problem should be undertaken. An appropriate model and/or specific guidelines that will promote the increased viability of farmers' groups to undertake mechanical drying, and postharvest functions in general, at the farm level, needs to be developed.

(b) Market and policy studies to determine the

levels of incentives that need to be incorporated in the pricing and grading system in order to encourage mechanical drying.

(c) Development of a workable grading system applicable in field conditions. In addition, mechanisms of enforcing the grading system should be investigated.

(d) Development of partial or pre-drying technologies in terms of hardware and software (i.e. management practices/drying schemes) within the context of the total drying operations of a government grain-handling authority and/or private millers/traders.

(e) Development of a methodology to critically determine and design the system's drying load.

(f) Pilot development projects to establish and demonstrate the profitability of mechanical dryers in an integrated postharvest operations system.

(g) Studies on steamlining mechanical dryer manufacturing, in order to reduce costs and standardise technical performance.

References

Alviar, N.G., Piadozo, E.S., Castro, Jr., E.C., and Lopez, J.H. 1981. Studies on the application of available agricultural engineering technologies in rice production. University of the Philippines at Los Baños (UPLB), College of Development Economic Management, (unpublished).

BAE (Bureau of Agricultural Economics) 1983. Statistics on 1982 regional paddy production. Quezon City, Bureau of Agricultural Economics.

Cardino, A.G. 1985. Terminal report: a socio-economic study on the utilization of mechanical grain dryer. Manila, National Post Harvest Institute for Research and Extension, (unpublished).

De Padua, D.B. 1985. Requirements for drying high moisture content grain in Southeast Asia. In: Champ, B.R., and Highley, E., ed. Preserving grain quality by aeration and in-store drying: proceedings of an international seminar, Kuala Lumpur, Malaysia, 9-11 October 1985. Canberra, ACIAR Proceedings No. 15 45-49.

Duff, B., and Toquero, Z. 1975. Technical and economic factors affecting the efficiency of mechanization in farm level rice post production systems. Presented at a workshop on rice post production technology, 1975. University of the Philippines at Los Baños.

Frio, A.S., and Manilay, A.A., ed. 1985. Coming to grips with the wet season grain handling problem in Southeast Asia. Manila, ASEAN Crops Post-Harvest Programme, 90 p.

Lorenzana, J.J. Pasion, P., Jr., Ramos, E.C., Viernes, N., and Rosimi, J. 1981. On farm postharvest practices and problems in Isabela, Philippines. In: Proceedings of the 4th annual workshop on grain post-harvest technology. Laguna, Southeast Asia Cooperative Post-Harvest Research and Development Programme 75-85.

MacCormac, C.W. 1985. Crop production postproduction relations: An economic framework for analysis.

Presented at seminar on grain post-harvest technology, ASEAN Crops Post-Harvest Programme. August 1985, Manila.

Mangaoang, C.C. 1984. Cost of drying. In: Frio, A.S., and Manilay, A.A., ed. Coming to grips with the wet season grain handling problems in Southeast Asia. Manila, ASEAN Crops Post-Harvest Programme, 65-74.

Mears, L.A., Agabin, M.H., Anden, T.L., and Marquez, R.C. 1974. Rice economy of the Philippines. Quezon City, University of the Philippines Press.

Mendoza, E., and Quitco, R. 1984. Quality deterioration and value loss in grain. In: Frio, A.S., and Manilay, A.A. ed., Coming to grips with the wet season grain handling problems in Southeast Asia. Manila, ASEAN Crops Post-Harvest Programme, 15-20.

Paz, R.R., and Cabacungan, R.P. 1986. Progress Report: Paddy loss assessment at the farm level operations. Manila, National Post-Harvest Institute for Research and Extension, 11 p.

Sison, O.F., Del Rosario, C.R., Adriano, M.S., and Del Rosario, C.A. 1983. Terminal report: Technologies and socio-economic dimensions of the transfer of agricultural engineering technology packages to small farms. Laguna, University of the Philippines at Los Baños, Department of Agricultural Education, 128 p.

Toquero, Z.F., and Duff, B. 1976. A profile of the rice post production industry in Camarines Sur. Presented at a regional workshop on rice post production technology. February 1976, Naga City.

ANNEX: CASE STUDIES

Four existing users of mechanical dryers were taken as case studies: two farmer associations and two private milling corporations.

Both farmers associations were irrigators' associations. The first, association A, was actively engaged in paddy trading, aside from rendering services to its members. It had 4 units of flat bed dryers with total capacity of 8 t to support its trading and milling business, as well as to provide drying services to its members. However, the total capacity of the dryers was not sufficient to dry the daily procurement of the association during the wet season, especially when there were a number of members who wished to use the drying services. Its daily drying requirements, excluding members needs, was about 12 t during the wet season. Consequently, members who wished to use the dryers were not all able to do so.

Association B, on the other hand, was mainly organised to provide threshing and drying services (the rice mill was still under construction during the period of the study). No paddy trading was involved and all the paddy processed was owned by the individual farmer members. The mechanical dryer was not fully utilised. Most of the members did not use it because it was expensive and also because of the inability of the association to service their requirements at peak harvest time. The single flat

bed dryer (2 t/batch) owned by the association was not sufficient to meet the drying requirements of the members. Association B had a total membership of 137 individual farmers who farmed 1.5 hectare lots with an average yield of 4 t/ha.

The private business corporations were both millers. The first rice mill was owned by one of the largest private corporations in the Philippines and had, by law, to fulfill the rice requirements of its employees. The mill had a monthly rice requirement of about 750 t or a total of 9000 t/year. To support its operation, one unit of continuous flow dryer was installed (2 t/hour).

The second private mill corporation was owned and operated by a family. It engaged in free marketing. Average volume of procurement ranged from 1000-1500 t/season. Aside from paddy trading, other crops such as peanuts and corn were also purchased. In fact, a larger volume of peanuts than paddy was purchased during the dry season. Paddy trading was mostly concentrated during the wet season. Thus, the mill's one unit of 2 t/hour continuous flow dryer was fully utilised. However, only about 60% of stocks procured were mechanically dried, the balance being sun dried when possible.

Evaluation of Solar and Husk-Fired Grain Dryers

Sarun Wattanutchariya*

Abstract

In order to obtain higher prices and better quality for storage or milling, paddy needs to be dried during the rainy season. However, due to lack of proper dryers and limited drying space, most farmers in Thailand are often found selling paddy of high moisture content at relatively low prices. This paper reports a study which evaluated the physical and economic performance of three different drying techniques which can be applied at farm level. The study found that drying on a concrete floor and solar drying, although both having relatively low operating costs, were not practicable, because of uncertainty in weather conditions. A husk-fired dryer, on the other hand, performed satisfactorily in all weather conditions but had a high investment cost. If only direct benefits were considered, there would, in any case, have been no incentive for farmers to dry their paddy, because of the relatively low prices at the time of the study.

RICE, the main staple food in monsoonal Asia, is particularly important to the Thai economy. It is the top foreign exchange earner and the major occupation of about 70% of the population. Each year, about 60 million rai (approximately 10 million hectares) are sown to rice, yielding a total paddy production of 20 Mt. About two-thirds of the product is consumed domestically while the rest is exported to the world market, where it makes up about 35–40% of the world rice trade.

The increase in rice production in Thailand is partly due to an increase in planted area, especially in the irrigated areas where double cropping can be practised over approximately 10% of the total cultivated area. Individual farms in Thailand are rather small, ranging from 1.5 to 4.5 hectares in different parts of the country. The average size is 3 hectares. The average production yields per hectare of the first and second crops are 1.6 and 3.3 t. Despite the better yield in the second crop, total farm income is usually lower because of reduced farm prices resulting from lower quality of the product harvested in the rainy season.

Storage of wet paddy causes severe quality deterioration. Because most Thai farmers do not have access to proper facilities for handling grain

after the harvest, they are forced to sell their products even though the offered price is low.

Providing farmers with a proper dryer would enable them to obtain a higher price for low moisture grain or to store it for sale when prices are favourable. Over the past few years, Thai Government agencies and private firms have tried to achieve this by developing a relatively low cost dryer to handle the postharvest paddy problem. For several years, the Asian Institute of Technology (AIT) has been developing a simple solar dryer designed to provide Thai farmers with a low cost dryer. The Agricultural Engineering Division (AED) of Department of Agriculture, assisted by the International Development Research Centre (IDRC) on the other hand, has developed a 2 t capacity batch dryer using rice-hulls as a heat source. This will soon be introduced to farmers.

An economic study, coupled with technical experiments, would enable designers as well as users to determine the appropriateness of the dryers and the factors affecting the adoption of this new drying technology.

The overall objective of the study reported in this paper was to study the physical and economic performances of different drying techniques. The study sought:

- to investigate present drying techniques;
- to compare costs and returns from different

* Department of Agricultural Economics, Kasetsart University, Bangkok, Thailand.

drying methods;

- to determine the appropriateness of different types of dryers at farm level.

Methodology

The data used in this study were obtained from the research project titled 'Application of Post Harvest Technology' conducted by the Storage and Processing Section of Agricultural Engineering Division, Thai Department of Agriculture. This research project is currently assisted by IDRC. In the project, comparative studies of concrete floor drying, AIT's batch type solar dryer, and AED's husk-fired dryer were performed by four university researchers representing four geographical regions of Thailand, namely:

Chiangmai University — Northern; Kasetsart University — Central; Khon Kaen University — Northeastern; Prince of Songkhla University — Southern (Fig. 1).

Cost and return analysis was employed to determine profitability from the operation of different drying methods in drying the second crop of paddy in the Northern, Northeastern, and Central regions. Due to the limitations in the data, the Southern region was not included in this study.

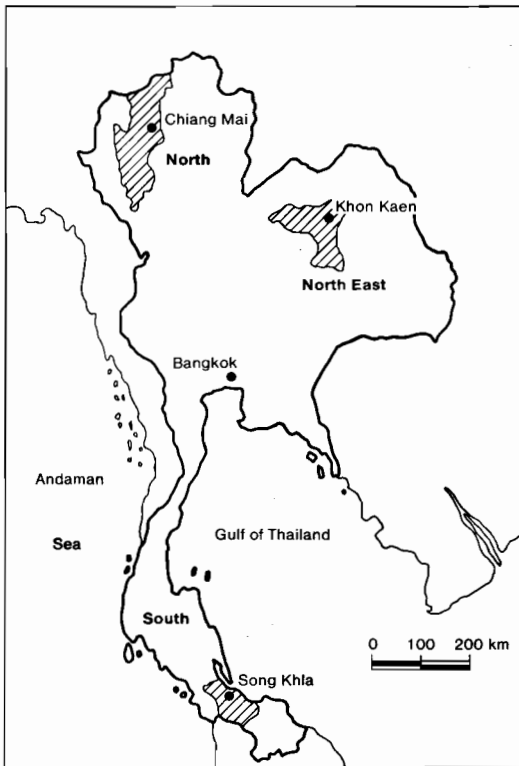

Fig. 1. Location of grain drying study areas in Thailand.

Current Farm-Level Drying Techniques

Sun Drying

Concrete Floor. Sun drying in the open air before and after threshing is the traditional method used by farmers throughout the Kingdom. Unthreshed paddy is sun dried by leaving small panicle bundles in the field for several days after manual cutting. Newly threshed paddy is sun dried by spreading it out on mats or on a concrete floor in a layer. Periodic stirring is required to obtain uniform drying. Sun drying on a concrete floor is commonly used at rice mills after purchase of high moisture paddy from farmers.

In the study, a 6m × 6m concrete floor capable of drying one tonne of paddy was constructed. Life expectancy of this concrete floor is 10 years.

AIT Solar Dryer. The idea underlying the design of the solar rice dryer developed in AIT is to heat a body of air in the sun and let this air pass through a flat bed of rice by natural convection, as shown in Figure 2. The dryer consists of a solar air heater, a box for the rice bed, and a chimney producing a tall column of warm air to increase the convection effect. Clear plastic sheeting covering the rice bed allows it to be heated from above by the sun while protecting it from rain. Black plastic sheeting is used to cover the ground and serves as a heat absorber. The AIT solar dryer is capable of drying one tonne of paddy. The drying period depends on the availability of sunlight. Life expectancy of the dryer is one year. In other words, all plastic materials have to be replaced. The construction cost of AIT's solar dryer ranges from 4000–5000 baht (during September 1986, 27 baht = US\$1) depending on the availability of the materials at each location.

Husk-Fired Dryer. Forced convection with heated air is believed to be the cheapest and simplest system

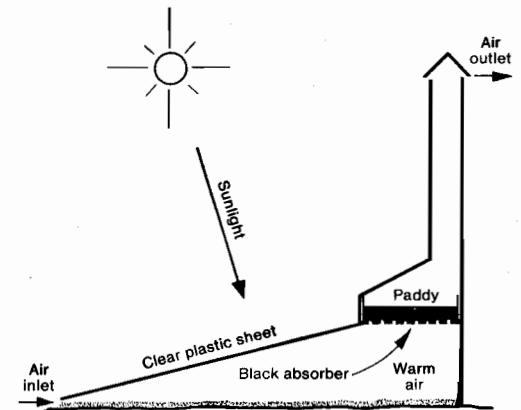

Fig. 2. Design concept of Asian Institute of Technology solar grain dryer.

suitable for farm drying. The AED husk-fired dryer (Fig. 3) consists of the following components:

1. Grain holding bin. A prototype grain holding bin was constructed of dimensions 2.44m × 2.44m × 0.6m and made from 6mm plywood stiffened by 40mm × 90mm lumber and a perforated sheet (mesh #8½) metal floor separating plenum from grain compartment. This bin can hold 2 t of paddy. A thermometer is placed at the bin side to monitor heat level.

2. Heat source. Two types of fuel, namely rice hulls and kerosene or diesel burners can be used as sources of heat. Normally, rice hulls are the cheapest source of fuel and are commonly found in the rural areas. In this study, a rice hull furnace was used as a source of heat. A 0.60m × 0.60m × 0.76m rice hull furnace prototype was constructed from ordinary bricks with an angle iron frame. It had a 45° inclined fire grate made of a series of 6 mm round bars 1.5 mm apart, arranged longitudinally.

The furnace is placed in front of a fan. Heated air coming out from the furnace has a temperature as high as 200°C, but the hot air sucked through the fan housing is only 43–60°C.

3. Fan and fan housing. A prototype cyclo-fan of 0.6 m rotor-diameter having eight 0.15m × 0.30m blades was used for delivering air at the rate of 107 m³/minute or 28 m³/minute/m³ of paddy. This fan is driven by a diesel engine of at least 8 h.p. output, of the type commonly used by farmers who own two-wheeled tractors.

The life expectancy of the dryer is 5 years with 5% maintenance costs, while the engine will last up to 10 years depending upon the amount of time it is used for other purposes.

The construction cost of the husk-fired dryer is 20 000 baht. The diesel engine costs 30 000 baht.

Physical Performance of the Dryers

Sun Drying on Concrete Floor

This traditional method depends solely on the period of sunshine during the day. As mentioned earlier, periodic stirring is required to obtain uniform drying. When it rains and during the night, labour is required to pile up the paddy and cover it with a plastic sheet. On the average, the labour requirement throughout the process for this method was 1 man-day per tonne of paddy. The moisture content of the grain was reduced from 20–22% to 12–14% within 3 days in all three regions, as shown in Table 1.

AIT Solar Dryer

The AIT solar dryer is designed to overcome some weak points of natural sun drying. For example, automatic circulation of hot air through the rice bed reduces the labour requirement for stirring and the plastic cover prevents grain from rewetting in case of rain. However, the performance of the dryer is still dependent on weather and humidity. The experiment in all three locations showed that, on the average, it required 6–8 days to reduce moisture content from 20–22% to 13–14%.

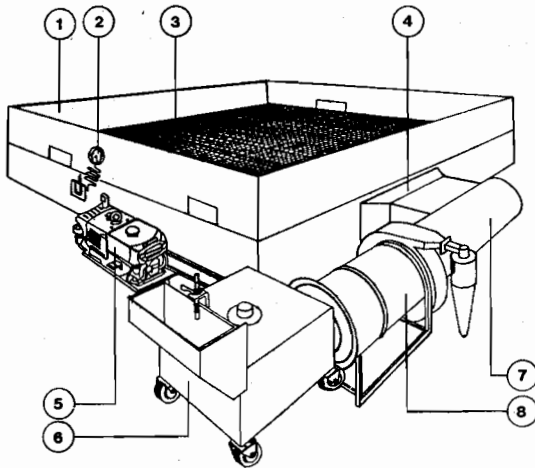

Fig. 3. Drawing of Agricultural Engineering Division, Thai Department of Agriculture, husk-fired dryer. Labelled parts are as follows: 1. grain holding bin; 2. thermometer; 3. perforated steel mesh; 4. canvas tube; 5. 8 h.p. engine; 6. rice hull furnace; 7. fan housing; 8. fan.

TABLE 1. Physical performance of dryers classified by types and locations.

Item	Concrete floor			AIT solar dryer			AED husk-fired dryer		
	Northeast	Central	North	Northeast	Central	North	Northeast	Central	North
Operating month	June	May	July	June	May	July	June	May	July
Quantity (kg)	1000	1000	1000	1000	1000	1000	2000	2000	2000
Pre-drying moisture content (%)	20.05	22.00	19.60	19.50	22.00	19.60	18.27	22.00	19.63
Post-drying moisture content (%)	12.77	14.00	12.80	13.77	14.00	13.30	13.77	14.00	13.63
Drying period (days)	3.00	3.00	3.30	8.00	8.00	6.00	0.25	0.33	0.25
Labour requirement (person-days)	0.91	1.00	0.94	0.42	0.88	1.25	1.10	1.45	1.75
Fuel:									
diesel (litre)	—	—	—	—	—	—	8.75	11.50	9.30
rice hulls (kg)	—	—	—	—	—	—	43.70	60.00	33.36

In general, AIT's solar dryer required less labour to operate than drying on a concrete floor, except in the northern location where stirring was also performed. It was reported that the inconvenience of loading and unloading grain required more working time.

AED's Husk-Fired Dryer

The husk-fired dryer was designed to avoid the delay in drying period due to uncertainty in weather. Heated air from the rice hull furnace reduced moisture content from 22% to 14% in 8 hours or approximately 1% per hour per two tonnes of paddy.

During the drying operation, one full-time labourer is required to feed rice hulls into the furnace and control the engine and temperature. Extra labour is required for loading and unloading paddy. The labour requirements for the method is around 1-2 person-days for two tonnes paddy. Diesel fuel consumed per hour of operation was about 1.5 litres or 7 kg/hour of rice hulls if these were used.

Economic Evaluation of the Dryers

The purpose of this section is to analyse costs of and returns from each drying method. Due to limitations in the information available, only direct benefit is considered, i.e. increase in value of the product after drying. Benefit from improvement in quality is neglected, since most farmers sell their product in paddy form and moisture content is the main factor determining product price.

Direct Benefit from Drying

In most regions of Thailand, weight deduction is commonly used in determining product price. The standard price is set at a moisture content of 14%. The weight deduction is 1.5% per 1% increase in moisture content until 20% moisture content, or 90 kg per tonne of paddy at 20% moisture content. For moisture contents higher than 20%, 2% of total weight is deducted for each 1% increase in moisture content. The difference in price between high and low moisture contents therefore depends on the starting price of the product. If the product price is high, the benefit from drying is relatively high. However, product price is determined by world prices and government pricing policy, which are beyond the control of farmers and local traders.

The value of paddy after drying is calculated by multiplying paddy price after drying by the ratio of dry matter before and after drying in order to take into account weight loss during the process. Increase in value of paddy after drying therefore depends on price of the product and amount of reduction in moisture content.

Paddy price fluctuates from month to month and varies from location to location. During the experiments, paddy price in May in the Central Region was higher than in June and July in the Northeastern and Northern Regions. The increase in value of paddy after drying in the Central Region was higher than in the other two locations as shown in Table 2.

TABLE 2. Economic evaluation of dryers classified by types and locations.

Item	Concrete floor			AIT solar dryer			AED husk-fired dryer		
	Northeast	Central	North	Northeast	Central	North	Northeast	Central	North
Variable costs (baht ^a /t)	45.50	70.00	47.00	21.00	61.60	62.50	61.00	92.02	77.38
Labour	45.50	70.00	47.00	21.00	61.60	62.50	27.50	50.75	43.75
Fuel:									
diesel							30.23	37.89	32.13
rice hulls							3.27	3.38	1.50
Pre-drying value (baht/t)	1780.00	2500.00	1850.00	1780.00	2500.00	1850.00	1780.00	2500.00	1850.00
Post-drying value ^b (baht/t)	1794.00	2607.00	1875.00	1826.00	2607.00	1885.00	1854.00	2606.50	1892.00
Increase in value after drying	14.00	107.00	25.00	46.00	107.00	35.00	74.00	106.50	42.00
Net return	-31.50	37.00	-22.00	25.00	45.40	-27.50	13.00	14.48	-35.38
Fixed costs (baht/year)	684.00	764.00	914.14	5139.00	5334.00	5156.00	12000.00	12000.00	12000.00
Depreciation ^c	380.00	427.00	508.00	4685.00	4865.00	4700.00	8000.00	8000.00	8000.00
Opportunity cost of investment capital (8%)	304.00	337.00	406.00	454.00	469.00	456.00	4000.00	4000.00	4000.00
Break-even point (t/year) ^d	—	20.60	—	205.60	117.20	—	923.00	828.7	—
Drying period (days)	—	60.00	—	1645.00	937.00	—	115.00	138.00	—

^a During September 1986, 27 baht = US\$1

^b Price of grain $\times \frac{1 - \text{pre-drying moisture content}}{1 - \text{post-drying moisture content}}$

^c Price paid for equipment — Salvage
Life expectancy

^d Annual fixed cost
Net return

Drying Cost and Return

Drying cost consists of variable and fixed costs. Variable costs per tonne of paddy were observed. For paddy dried on a concrete floor and in AIT's solar dryer, labour is the only variable cost. For AED's husk fired dryer, the additional cost of the heat source must be added. Table 2 shows that AIT's solar dryer has the lowest variable cost per tonne of paddy, except in the Northern location.

Net return from drying is the difference between the increase in value of paddy and the variable cost. The AIT solar dryer again shows highest net return, except in the Northern location where negative net returns for all drying methods are obtained.

Fixed cost comprises depreciation cost and opportunity cost of investment capital. Since the total quantity of the paddy dried was not available, annual fixed cost is presented in this study. Fixed cost for each drying method varies substantially from 700-900 baht for the concrete floor to 12 000 baht for the husk-fired dryer. The average annual fixed cost of the AIT's solar dryer was about 5 000 baht.

The break-even quantity of paddy that needs to be dried in order to cover both variable and annual fixed cost was calculated by dividing annual fixed cost by net return. For concrete floor drying in the Central location the break-even quantity was 20.6 t for a period of two months (1 t for 3 days).

The break-even quantities for the AIT solar dryer were 205.6 and 117.2 t for the Northeastern and Central locations, respectively. This drying quantity is not possible when the drying period required for the process is considered. Owing to the high fixed cost of the husk-fired dryer, break-even quantity was about 800-900 t, necessitating about 4 months of 24 hour operation.

Conclusions and Recommendations

Drying of paddy harvested in the wet season is necessary in order to obtain higher prices and better quality for storage or milling. However, most farmers are often found selling high moisture paddy at relatively low prices because of unavailability of the proper dryer and limited drying space.

The purpose of this study was to evaluate physical and economic performance of the three drying methods which can be applied at farm level, namely: (a) Drying on concrete floor; (b) AIT solar dryer; and (c) AED husk-fired dryer. The advantages and disadvantages of each drying method can be summarised as follows:

(a) Drying on concrete floor

Advantages

1. Low construction cost

Disadvantages

1. High percentage of loss

2. Easy to construct and operate
2. Depends on weather conditions
3. Labour-intensive

(b) AIT solar dryer

Advantages

1. Low construction cost
2. Low operating cost
3. Able to protect paddy from rain
4. Low percentage of loss or damage
5. Less labour-intensive

Disadvantages

1. Equipment not durable
2. Long drying period
3. Small capacity
4. Inconvenience in loading and unloading
5. Depends on weather conditions
6. High maintenance cost

(c) AED husk-fired dryer

Advantages

1. Short drying time
2. Minimum loss and damage
3. Low operating cost
4. Continuous operation in all weather conditions
5. Larger capacity

Disadvantage

1. High investment cost

From the above information, it can be concluded at this stage that the appropriateness of each drying method depends on the quantity of the product and the investment capacity of its owner. For farmers with larger farm holdings, types (a) and (b) will not be appropriate.

With regard to benefit from drying, as mentioned earlier only the direct benefit was considered in this study. Therefore, if other indirect benefits, such as those from reduced qualitative losses and storage costs, were included, the total benefit will be increased to some degree. The low paddy price at present (lowest for 5 years) has reduced the benefit of paddy drying. More intensive use of the dryers to dry products besides rice is recommended in order to increase their annual benefit.

References

- Exell, R.H.B., and Sompong Boonthumjinda 1984. Solar rice drying project (Thailand). Bangkok, Asian Institute of Technology, Research Report No. 171.
- MacCormac, C.W. 1985. Economic analysis for evaluating grain drying and milling technology: some suggested techniques. Presented at rice post harvest technology (Thailand) workshop for project collaborators and engineers. September 1985, Chiangmai, Thailand.
- Thongsawang, M. et al. 1978 Design and development of a farm dryer. Bangkok, Thailand, Agricultural Engineering Division, Department of Agriculture.

Estimates of Cost Functions and Costs of Various Paddy Postharvest Handling Activities in Malaysia

Mohd Ghazali Mohayidin *

Abstract

This paper gives cost estimates of individual components of paddy postharvest operations, obtained from data collected during the 1984-85 harvesting seasons. Models of assembly, milling, and drying costs are developed. In addition, individual cost components of the marketing chain are generated. The results indicate significant differences across cost categories. These account for the differences in harvesting operations between Malaysia and other ASEAN countries.

OVER the last three decades, levels of paddy production have increased through the introduction of new high-yielding varieties and the provision of irrigation schemes that permit double cropping. While postharvest handling operations of paddy are becoming increasingly important, with the increasing output levels, significant postharvest losses still occur. Estimates of postharvest losses in paddy experienced in Malaysia range from 10% to 37%. Postharvest losses through manual handling of paddy during harvesting have been reported to be as high as 20%, while during threshing, drying, and storage, losses are between 5% and 17%. Losses between 2% and 10% have been recorded during milling. The major causes of grain damage and loss are improper methods of grain handling, drying, and storage, and inadequate facilities (Leong and Fredericks 1986).

Malaysia is currently about 75% self-sufficient in the production of rice and would come closer to self-sufficiency if postharvest losses were reduced. The Malaysian National Paddy and Rice Authority (Lembaga Padi dan Beras Negara, LPN) believes that the introduction of new technologies and innovations in the handling and milling of paddy and distribution of rice, more efficient drying equipment, an appropriate milling capacity to reduce delays, and an improved grading and pricing system will reduce postharvest losses significantly.

The Malaysian Government, through LPN, in making investment plans pertaining to the improvement of handling facilities, is confronted with the complex recurring problem of determining the most efficient locational pattern, number, and size of procurement centres, drying plants, and rice mills.

The Malaysian Government, through the Economic Planning Unit, requested assistance from and collaboration with Australian institutions involved in research on these types of problems. LPN identified problems associated with bulk handling as an area where Australian expertise was appropriate. A proposal to conduct economic research on bulk handling of paddy and rice was subsequently accepted as a collaborative project with the Australian Centre for International Agricultural Research (ACIAR).

Project Objective

The basic aim of the project on the economic analysis of bulk handling of paddy and rice in Malaysia is to develop a model of the rice industry which integrates all diverse components of the paddy and rice handling sector. The model is evaluated empirically using data collected in the Tanjong Karang paddy growing area in Northwest Selangor. The extent to which the model is generally applicable to other rice producing regions will be assessed. The model will be used to analyse alternative paddy transport and handling activities, as well as paddy grading and pricing systems, so as

* Faculty of Resource Economics and Agri-Business, Universiti Pertanian Malaysia, Serdang, Selangor.

to determine the most socially efficient locational pattern, number, and size of paddy handling and rice distribution facilities.

Since the project was still in progress at the time of writing, this paper focuses on some preliminary results of several components of the project which deal with the estimation of cost functions. Emphasis is given to the component dealing with transportation and queuing costs of grain handling facilities currently utilised in the Tanjung Karang area.

The Flow of Paddy and Rice

The location, number, and size of paddy handling and processing facilities, and the spatial and temporal flows of paddy, influence and are influenced by the behaviour of a number of participants in the physical handling and processing system. A flow chart of the system is given as Figure 1. The principal areas of participation in the paddy handling, processing, and transportation system are paddy production, contract carting, drying, storage, milling of paddy, and transportation and utilisation of rice (Ryland and Hansen 1985).

Harvested paddy is sold by the farmers either to LPN agents or licenced private paddy buyers, or directly to LPN milling complexes. The farmers, however, are encouraged to sell their paddy at the procurement centres operated by LPN agents or licenced private buyers. These small procurement centres are located at various places convenient to the farmers. The paddy is then taken to the Authority's complexes or private mills for processing.

At the farm level, harvested grain is placed in

gunny sacks before it is transported to the procurement centres. The most important means of transportation at this stage of the marketing chain are motor cycles and small lorries. The process of buying and selling is concluded at the procurement centres. It then becomes the responsibility of the buyer to store and finally transport the paddy to the milling complexes. Both small and large lorries are used at this stage.

The process of loading and unloading is done manually, except at some milling complexes where unloading is assisted by motorised conveyer belts.

In the transportation of paddy from the field to the milling complexes, vehicles are often required to queue at the procurement centres and the mills. At the procurement centres, queuing occurs while the paddy is graded and transaction concluded. Queuing also takes place during the process of loading paddy onto the vehicles. At the mills, the lorries are required to queue at the weigh-in bridge before and after unloading.

In Peninsular Malaysia, drying of paddy is undertaken by private millers, LPN complexes, procurement centres, or farmers organisations. However, the bulk of drying takes place at the milling complexes.

Storage of paddy is also undertaken by the various organisations involved in the physical handling of paddy. These include cooperative stores, LPN stores, and the procurement centres, as well as the private commercial millers

Rice milling involves the removal of the husk in order to produce edible polished rice. In Malaysia, the average recovery rate is about 65% milled rice.

Transportation of the milled rice from rice mills to market is normally carried out by contract lorry operators.

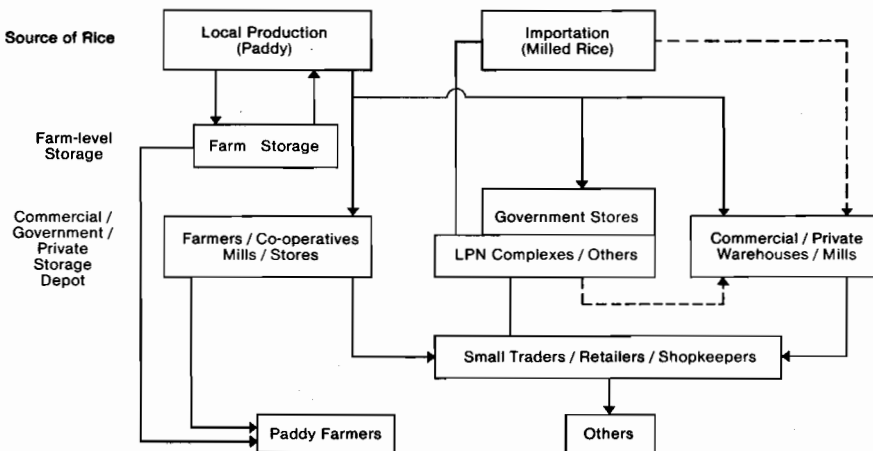

Fig. 1. Flow chart for paddy and rice in Peninsular Malaysia.

Analytical Framework

The main emphasis of this study was to derive cost functions of transportation activities. However, the paper will also touch on other cost functions pertinent to the flow of paddy and rice from the field to the consumer.

Transport Cost Function

In this study, road transport costs were divided into three major categories:

(a) transfer costs, i.e. the cost of loading and unloading the vehicle, which is a fixed amount per trip and is independent of the distance;

(b) variable costs that varied directly with trip distance; and

(c) fixed costs that were a fixed amount per annum and independent of distance travelled.

The total transport cost was then represented as follows:

$$TC = A + (B + C)2D \dots\dots\dots (1)$$

where

TC = total transport cost,

A = transfer costs,

B = variable costs,

C = fixed costs, and

D = trip distance of a one-way trip

The study took into consideration the fact that the distribution of vehicle types and sizes varied with the trip distance. The overall operating and capital costs for a particular distance-class were obtained by weighting the cost figures for each vehicle type-size combination by the proportion of all paddy delivered by the vehicles in that distance class which were of that vehicle type-class combination. Detailed computations of this technique can be found in Kerin (1985) and Ghazali and Muzaffar (1986).

Road Transport Charges

To determine the relative importance of the factors affecting contractors charges, a road transport charges model was specified:

$$RC = a + bQ + cD + dQC \dots\dots\dots (2)$$

where

RC = road charges, i.e. contractor's charge (¢/t)

Q = quantity per load (t)

D = trip distance (km)

QC = expected queuing cost (¢/t) and

a,b,c,d = coefficients to be estimated.

Queuing Cost Function

In this study, it was also necessary to impute values for labour-time spent in driving the vehicle,

queuing, and the transfer activities of loading and unloading the vehicle. In this case, the opportunity cost of labour was assumed to be equivalent to wages paid to the workers involved in the above activities. In addition, the opportunity cost of the idle vehicle was also included as a part of the queuing costs. Differences in the valuation of opportunity cost between farm vehicle and contract vehicle were taken into consideration. Opportunity cost of farm vehicle during harvest was taken as zero because it was assumed that the vehicle had no alternative use during harvest except carrying grains.

For the purpose of estimating queuing cost function, the weighted average costs of both the farm and contract vehicles were used.

The form of queuing cost function is as follows:

$$TQC = e + fQR - gNW \dots\dots\dots (3)$$

where

TQC = total queuing cost over the harvest period,

QR = total receipts,

NW = total number of workers, and

e,f,g = coefficients to be estimated.

Total Drying Cost Function

Total drying cost of paddy varies with the quantity of output. There are, of course, other factors specific to a particular plant's operation which may influence this relationship.

In general, the relationship is given as:

$$DTC = h + iDQ \dots\dots\dots (4)$$

where,

DTC = total drying costs,

DQ = amount of paddy dried, and

h,i = coefficients to be estimated.

Total Milling Cost

For the milling cost function, various functional forms were used and satisfactory results were obtained using the linear form:

$$MTC = j + kMQ \dots\dots\dots (5)$$

where

MTC = total milling costs,

MQ = amount of paddy milled, and

j,k = coefficients to be estimated.

Rice Transport Costs

Transportation of rice from the mills to the market place is represented by a linear function:

$$QR = l + mDM \dots\dots\dots (6)$$

where

QR = total cost of rice transported,

DM = distance to the market, and

l,m = coefficients to be estimated.

Results of the Study

Transport Cost Function

Table 1 shows the overall operating and capital costs in a particular distance class. The per kilometre costs given in the table were based on a one-way trip distance. To obtain the relevant figures for a round trip, the values were multiplied by two.

Discontinuities in the transport cost function (Table 2) arose because the transport costs were separately estimated for a number of discrete distance ranges. In order to arrive at a continuously increasing function of distance, the mid-points of each distance range were joined by linear segments (Table 3 and Fig. 2).

Road Transport Charges

To determine the relative importance of factors affecting transportation charges, a linear model was specified. Three variables that were expected to

affect the charges were quantity of grain transported, trip distance, and expected queuing cost.

The estimated model is given below:

$$RC = -0.9114 + 8.8989 Q + 0.6008 D + 2.6909 QC$$

(17.683) (4.053) (18.045)

The figures in parentheses are t-values. The R^2 value was 0.9215.

The road transport charge (RC) was positively related to the quantity of grain transported (Q), trip distance (D), and expected queuing cost (QC).

Queuing Cost Function

In this study, queuing costs were determined by the value of time and the amount of time spent in the queues. Wages paid to the workers were used in the valuation of labour time. The linear function estimated in this study is as follows:

$$TQC = 8.5602 + 14.22 QRD - 7.3780 NW$$

(40.34) (-6.33)

TABLE 1. Paddy transport costs by distance classes

Distance (km)	Fixed costs (¢/t/km)	Variable costs (¢/t/km)	Total fixed and variable costs (¢/t/km)	Transfer costs (¢/t/trip)
0-3.0	4.75	28.13	32.88	19.99
3.0-5.0	4.78	28.20	32.98	22.65
5.0-10.0	2.16	9.58	11.74	20.58
10.0-20.0	1.09	2.89	3.98	33.92
20.0-30.0	1.11	3.09	4.20	38.39
30.0-40.0	1.23	3.72	4.95	36.04
Over 40.0	0.90	3.10	4.00	25.83

TABLE 2. Per tonne total costs and per tonne operating costs of paddy transport.

Distance (km)	Total operating costs (¢/t)	Total capital and operating costs (¢/t)
0-3.0	19.99 + 56.26D ^a	19.99 + 65.76D
3.0-5.0	22.65 + 56.40D	22.65 + 65.96D
5.0-10.0	20.58 + 19.15D	20.58 + 23.48D
10.0-20.0	33.92 + 5.78D	33.92 + 7.96D
20.0-30.0	38.39 + 6.18D	38.39 + 8.40D
30.0-40.0	36.04 + 7.44D	36.04 + 9.90D
Over 40.0	25.83 + 6.20D	25.83 + 8.00D

^aD = one-way trip distance. See text for explanation.

TABLE 3. Paddy transport costs as a continuous function of one-way trip distance (D).

Distance (km)	Total operating costs (¢/t)	Total capital and operating costs (¢/t)
0 < D ≤ 1.5	19.99 + 56.26D	19.99 + 65.76D
1.5 < D ≤ 4.0	104.38 + 57.55(D - 1.5)	118.63 + 67.14(D - 1.5)
4.0 < D ≤ 7.5	248.26 + 23.99(D - 4.0)	286.48 + 25.66(D - 4.0)
7.5 < D ≤ 15.0	164.30 + 5.82(D - 7.5)	196.67 + 5.78(D - 7.5)
15.0 < D ≤ 25.0	120.65 + 7.22(D - 15.0)	153.32 + 9.51(D - 15.0)
25.0 < D ≤ 35.0	192.85 + 10.36(D - 25.0)	248.42 + 13.41(D - 25.0)
35.0 < D ≤ 45.0	296.45 + 0.84(D - 35.0)	382.52 + 0.33(D - 35.0)
45.0 < D	304.85 + 6.20(D - 45.0)	385.82 + 8.00(D - 45.0)

The figures in parentheses are the t-values. All the coefficients were highly significant and they were all of the expected signs. The model also gave a high R^2 of 0.7632.

The model shows that the total queuing costs were positively related to the amount of grain received and negatively related to the number of workers at the receiving sites.

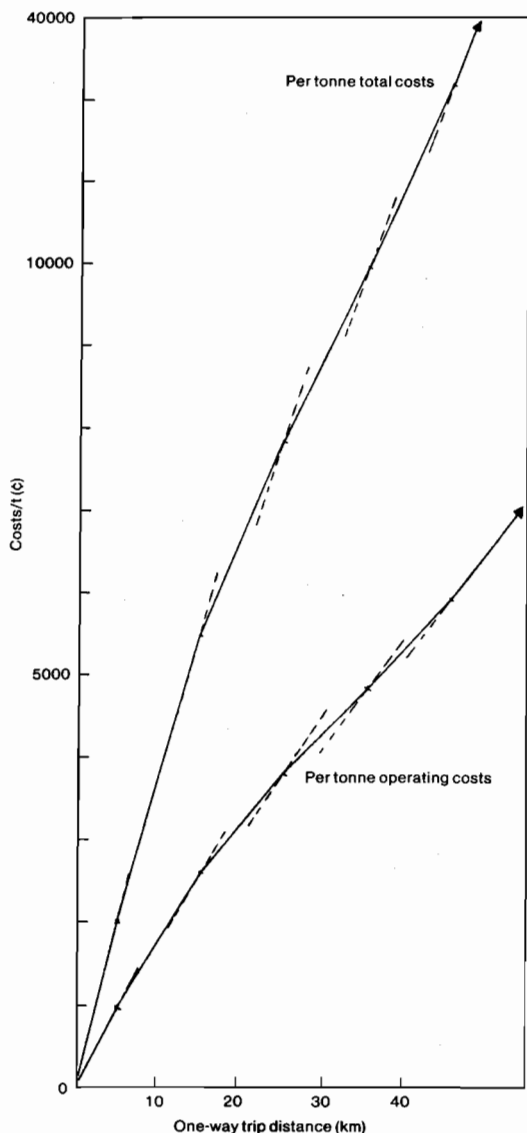

Fig. 2. Per tonne total costs and per tonne operating costs as a function of one-way trip distance for all vehicles.

Total Drying Costs

The estimated linear relationship of the total drying cost function is:

$$DTC = 144.162 + 9.355 DQ \quad (3.77)$$

The R^2 was 0.24. The result indicates that there was a direct relationship between total drying costs and the quantity of paddy dried.

Total Milling Costs

The estimated function is:

$$MTC = 149.356 + 5.142 MQ \quad (1.790)$$

The R^2 was quite low, i.e. 0.0355. The estimated coefficient of the amount of paddy milled was positive, indicating that the total drying costs varied directly with output.

Rice Transport Cost Function

The estimated linear function of rice transport cost is as follows:

$$QR = 6.53 + 0.114 DM \quad (0.06)$$

The R^2 was 0.75. The result indicates that the total cost of transporting rice from the mills to the consumer is directly related to the distance travelled.

Relative Importance of Postharvest Costs

The analysis above provides econometric estimates of individual components of postharvest costs, viz. assembly, drying/storage/milling, and distribution costs of rice. We have used these econometric estimates of unit costs in an activity analysis model of bulk handling of paddy and rice applied to the Tanjong Karang area of West Malaysia (ACIAR 1986). Table 4 gives the percentage distribution of each cost component generated using the model, assuming that each participant in the marketing chain is rational and seeks to minimise his perceived costs.

Of these costs, which reflect an annual production period of two harvesting seasons, the costs of assembly of paddy accounted for approximately 20% of the total marketing costs. On the other

TABLE 4. Percentage contribution of different components to total postharvest cost.

Component	% contribution
Paddy assembly	19.47
Drying	37.53
Storage	0.79
Milling	35.29
Rice distribution	6.92
Total	100.00

hand, drying accounted for nearly twice this figure. Farmers in Malaysia, acting rationally, delivered paddy with high moisture content into the paddy procurement system and this resulted in the very high costs of drying. However, the costs of paddy storage were low because millers processed paddy as fast as possible to meet domestic requirements. The cost of rice distribution also includes storage of milled rice and this accounted for around 8% of total postharvest costs from off-farm to wholesale level.

The above results of the model serve to demonstrate the relative importance of individual components of postharvest operations in the marketing chain of paddy and rice in Malaysia. Malaysia, however, is probably atypical in terms of ASEAN postharvest operations for paddy and rice. Firstly, little or no paddy is stored at farm level and all paddy immediately after harvest enters the paddy trading channels. Secondly, drying of paddy at integrated mill complexes is a major component of postharvest operations when compared with results of other ASEAN countries. In ASEAN as a whole, probably less than 10% of paddy is mechanically dried. Thirdly, the relatively low storage costs of paddy compared with milled rice reflect the excess capacity of mills to mill all paddy available as fast as possible and to store milled rice rather than paddy. These differences in postharvest operations reflect the different incentive systems and industry regulations currently operating in Malaysia.

Summary and Conclusions

This paper records estimates of individual components of the postharvest marketing chain for paddy and rice in Malaysia obtained from survey data collected during the 1984-85 harvesting season. Models of assembly, milling, and drying costs are developed and specified, and empirical cost estimates obtained. In addition, individual cost components of the marketing chain are generated from preliminary optimal solutions of the model.

The results indicate significant differences across cost categories and these differences account for the different harvesting operations. There are also significant differences in the relative importance of these operations when compared with other ASEAN countries. Most of the differences in the performance of the postharvest sector are related to the significant differences in paddy procurement and rice pricing policies in Malaysia (see Chew and Arshad 1986).

References

- ACIAR 1986. Bulk handling of paddy and rice in Malaysia. Presented by ACIAR Project 8344 at 9th annual technical seminar on grain postharvest technology, ASEAN Crops Post-Harvest Programme. August 1986, Singapore.
- Chew, T.A., and Arshad, F. 1986. Comparative paddy pricing systems in ASEAN. Presented at 9th annual technical seminar on grain postharvest technology, ASEAN Crops Post-Harvest Programme. August 1986, Singapore.
- Fredericks, L.J., and Wells, R.J.G. 1983. Rice processing in Peninsular Malaysia: an economic and technical analysis. Kuala Lumpur, Oxford University Press, 300 p.
- Ghazali, M., and Muzaffar, S. 1986. Transportation and queuing costs of grain handling facilities in Tanjong Karang. Presented at 9th annual technical seminar on grain postharvest technology, ASEAN Crops Post-Harvest Programme. August 1986, Singapore.
- Kerin, P.D. 1985. Number and size of grain handling facilities in South Australia: road and queuing costs at handling facilities; 1983-84 harvest survey. Adelaide, Department of Agriculture, Technical Report No. 68.
- Leong, E., and Fredericks, L.J. 1986. Postharvest food handling problem in Malaysia. Presented at Seminar on food security and policy issues, Universiti Pertanian Malaysia. July 1986, Serdang.
- Ryland, G.J., and Hansen, B.R. 1985. Bulk handling of paddy and rice in Malaysia — model development and specification. Presented at 8th annual technical seminar on grain postharvest technology, ASEAN Crops Post-Harvest Programme. August 1985, Manila, Philippines.

Case Studies Chairman's Summary

Ampol Senanarong *

THIS very interesting final group of papers presented us with case studies on the introduction of technological change into the postharvest systems of four ASEAN countries.

Dr Mulyo Sidik from Indonesia described how dramatic increases in production in his country, resulting from the introduction of high-yielding varieties and other innovations, had created a storage problem for the National Logistics Agency (BULOG) and had led to high losses of the order of 3-5% per year.

BULOG has tackled the problem in a number of ways. It has built new storages that take matters of hygiene, sanitation, and pest control into account and impose strict standards on storages rented from the private sector. Storage management has been improved. Changes have been made to procurement practices, in terms of standards, grading, and pricing policy. An incentive payment to cover drying cost has been introduced. New pest control technology has been adopted, as part of BULOG's Integrated Storage Pest Management Program (ISPM). By these and related means, BULOG has reduced storage losses to an estimated 0.3%.

Ms Gloria Picar, in a paper with Ms Angelita Cardino, presented the results of an investigation of the reasons for the low level of adoption of mechanical dryers in the Philippines, as the second case study. The reasons appear to be mainly socioeconomic. Although there is certainly an acknowledged need to use mechanical dryers to arrest the spoilage of freshly harvested grain, factors such as high fuel costs, inappropriate dryer capacity, lack of capital to purchase, poor product quality due to use of improper operating conditions, and inadequacy of current extension programs militate against their use. Also, and this was a message that was received many times during the seminar, the grading and pricing system gives no incentive to farmers to dry their crop. In other words, it costs more to dry the paddy than the return from doing so. The authors conclude that the government should concentrate on farmer organisations or large commercial bodies in endeavouring to have newer drying technology adopted in the Philippines.

In the third paper of the session, Dr Sarun presented the results of a technical and economic evaluation of solar and husk-fired dryers for drying paddy at farm level during the wet season. Three types of drying were compared: traditional sun drying on a concrete floor; a solar dryer developed by the Asian Institute of Technology; and a husk-fired dryer developed in the Thai Department of Agriculture.

The study concluded that the appropriateness of each drying method depends on the quantity of product to be dried and the investment capacity of its owner. While the solar drying strategies are cheap, they are not practicable because of weather and are not suitable for farmers with large holdings. The husk-fired dryer performed well in all weather conditions but has a high capital cost. There was, in any case, no incentive to dry at the time of the study, because of low paddy prices.

* Department of Agriculture, Bangkok, Bangkok 10900, Thailand.

In the final paper, Dr Ghazali described determination of the functions to be incorporated into a model of the Malaysian paddy and rice industry. Drying and milling together accounted for some 70% of total postharvest cost, with paddy assembly cost another major contributor (20%). There are significant differences between Malaysia and other ASEAN members in the relative importance of the costs applying to different postharvest operations. Most of these are related to paddy procurement and rice pricing policies in Malaysia. Dr Ghazali tabulated postharvest costs and returns, which suggest that the Malaysian rice processing industry runs at a loss.

Concluding Session

Summary of Seminar Economic Issues in New Technology for Postharvest Handling, Storage, and Transportation of Grains in the Humid Tropics

J.V. Remenyi *

THREE critical factors underly the change that is sweeping across the canvas of postharvest problems in cereal handling in the humid tropics. The first of these is the result of technical progress in production, a spin-off of the 'green revolution'. The combination of improved high-yielding varieties, superior cropping practices, higher levels of inputs (especially fertiliser, water, and controls for weeds, pests and fungi), and shorter duration varieties (making the sowing of a second and in places even a third crop in the one year a practicality) has resulted in substantial increases in physical volumes of grains that need to be harvested, threshed, bagged, dried, protected from pests and damage by moulds or pathogens, safely stored, processed, packaged, and distributed. This sequence does not pose an inordinate problem when harvesting occurs in the dry season, as has been the age-old tradition.

But, with the spread of irrigation and short-duration modern varieties of rice, wheat, corn, and legumes (e.g., soybeans and chick-peas), areas where more than one crop per year is the norm have proliferated. As a result, the volumes of grain that are harvested in the wet season have also increased. The wet makes postharvest drying more difficult but also more critical if quality of the grain is to be maintained. High levels of humidity during this season limits the effectiveness of traditional sun drying or forced-ambient-air convection systems, while also increasing the risks of loss from moulds, insects, toxic diseases, and hot-spots in the grain bulk. Farmers, government officials, and entrepreneurs involved in the postharvest grains sector in humid tropical countries have turned to science to see if new technology can help reduce these losses.

The second factor is often referred to as the commercialisation of third world agriculture. Chronically high levels of population increase in developing countries, plus the inexorable drift towards a more urban-based society, means that an increasing number of developing country households is dependent upon non-farm employment and purchased foodstuffs for their livelihood. In most developing countries, the subsistence household will continue to be commonplace for some time yet, but with time is becoming less and less the norm. Consequently, a dominant trend in Third World agriculture is spreading dependence of households on purchased foodstuffs and parallel shift to higher and higher levels of marketed surplus from rural households. Subsistence oriented on-farm storage methods are gradually surrendering their importance to commercial distribution and marketing channels designed to fill the food needs of the ever expanding urban and non-farm rural household-sectors. As the proportion of domestic output entering these marketing channels increases, the capacity and efficiency of traditional postharvest drying,

* ACIAR, G.P.O. Box 1571, Canberra, A.C.T. 2601, Australia.

storage, and marketing systems are being tested. Where they have failed, new systems have been put in place or are being sought, often under government sponsorship and/or monopoly. It is not clear from anecdotal evidence to hand that government intervention of such an entrepreneurial sort is the most appropriate or best response to these problems. What little empirical analysis there is, suggests that where traditional systems are failing, the root cause of failure is not an inability of the system to adapt and evolve, but the persistence of policies, practices, and pricing systems that dilute the incentive to adapt. In these cases, it is not necessarily new technology that is wanting, but a reform in pricing policies to better reflect market rewards for grain-quality and effective postharvest handling of grains, especially in the wet season.

The third critical parameter is the rise in real incomes and levels of food security, especially in Asia, where chronic famines are remembered as a thing of the past. With increased real income, consumers in developing countries have become more sophisticated and discriminating in choosing between different qualities of grain. The dramatic decline in rice and wheat prices during the 1980s has accelerated this trend by rendering premiums for quality — as measured by characteristics such as water-content, colour, percentage of foreign matter per bag marketed, and percentage of broken grains at milling — larger, as a percentage of prices received by farmers. This has meant an increased awareness of the postharvest-loss problems in grains production, increasing demand from farmers for ways in which these losses can be cost-effectively contained, and pressure on governments to contain growth in the hidden subsidies for poor postharvest practices that characterise too many grains procurement and distribution systems in the humid tropics. These are tasks not just for engineers and food scientists, but also economists, anthropologists, other policy analysts, plant breeders, entomologists and other biological plant scientists, and statisticians.

Goals of Postharvest Technology and Policy Research

These three parameters — increased importance of the wet season harvest, the shift to commercialised agriculture, and the rise of the discriminating consumer — define the goals sought in allocating research resources to the study of postharvest problems of grains in the humid tropics. These goals can be summarised as follows:

(a) to protect gains made in the productivity of grain production by reducing/containing losses during postharvest handling, storage, and distribution.

(b) to anticipate and assist in appropriate structural adjustment to an environment of increasing levels of marketed surplus.

(c) to encourage the creation by researchers and the adoption by farmers and entrepreneurs of appropriate technologies that meet the needs of both consumers and producers. This will require empirical identification of where in the postharvest chain interventions can be cost-effectively made.

(d) to identify primary constraints to a more effective and efficient postharvest grains sector. This requires a critical examination of whether it is the flow of innovations available or the policy-environment/structure-of-profit-incentives that is the key log in the jam. Public funding for research on technical solutions to problems caused by a jaundiced set of pricing policies is not an optimal use of society's scarce research resources.

Questions Remaining Unanswered

Are policy analysts and technology researchers talking past one another?

The problems of losses in postharvest handling, storage, and transport of grains in the humid tropics are often not well defined or expressed. As a result, it is often easier to seek a technical solution than to go back to taws and redefine the problem in a way that is equally understandable to policy makers, engineers, plant scientists, or socioeconomists. For example, it is often said that a critical cause of high

postharvest losses in grains is excessive water content. The technical solution preferred has stressed alternative grain drying strategies, including quicker delivery of grain from the field to central drying stores and handling depots. In economic terms, however, it is not clear that this scenario is in society's best interest. By framing the problem in technical terms, the potential for a non-technical solution can too easily be ignored or missed.

If policy analysts and physical scientists are to collaborate — as they must — there is a need for a broader and more market-oriented conceptualisation of the problems of physical and economic losses in the postharvest sector. This demands greater sensitivity to existing incentives to the adoption of practices and technologies that reduce postharvest losses. Consider, for example, the problem of excess moisture content referred to above. Certainly it is possible to design and construct a technical/engineering solution to this problem. But this does not mean that such a solution is needed. It could be that the moisture content problem is the direct result of prices paid to farmers that reflect payment for weight of grain delivered, pure and simple. In such circumstances, which are not uncommon in many developing countries, the problems of moral hazard abound: there is every incentive for farmers to swell the weight of grain delivered by soaking the grain or minimising grain drying prior to transport to the procurement depot. A pricing system that passes the costs of drying back onto the farmer is likely to be an important element in the successful solution of this problem. Depending upon the circumstances, a revised pricing mechanism may not be the whole solution, but it is likely to be critical to the widespread adoption by farmers of more effective and new grain drying technologies. The achievement of this happy result is contingent, however, on significant improvement in dialogue between policy analysts and the technical researchers in the postharvest sciences.

Are the economists' models of postharvest systems useful?

Hitherto, economic model builders who have examined the postharvest grains sector have done so to serve the interests of developed country grain producers and grain handling authorities. Their models have, therefore, been perceived to be largely irrelevant to the postharvest problems of grains in the humid tropics. Bulk handling, mechanical harvesting, and transport by truck are not commonplace in the tropics. Postharvest handling of grains in developing countries tends to be small-scale and labour intensive. However, this situation is changing, especially as the proportion of output given over for commercial disposal increases. Even if on-farm practices remain small-scale and labour intensive, storage and handling by grain merchants, farmer cooperatives, and government procurement centres quickly approaches a scale analogous to the bulk handling systems of developed country cereal exporters. Certain questions arise, therefore. Can the developed country models be adapted to usefully reflect options and problems faced in developing countries? How might this be achieved? What level of research resources will be required? Can the data hungry characteristics of such models be overcome or accommodated in developing countries? Are smaller models addressing specific policy issues possible? What are the critical components of the system that ought to be modelled?

Are the problems of the postharvest grains sector in the humid tropics being accurately/adequately specified?

A ubiquitous characteristic of technology developed for the solution of postharvest problems of grains in humid countries is an excessively low adoption rate by the supposed clients of the new technology. Why? What can we learn from this experience? Is there a need to review the record? Technology has been developed to meet problems that we thought we understood, only to find that too often we were not right. Less of an engineering and more of a multidisciplinary approach from the outset may avoid a great deal of wasted effort. A clear manifestation of this is the bias in research on the supply-side of the postharvest problem. Very little attention has been given to the demand side, especially where this may involve the creation of new commodities as the best way of enhancing value added. Economic methods for analysing the demand side are sadly underdeveloped.

Conclusion

There has been a tendency to underestimate the power of market forces to assist in solving postharvest grain problems in developing countries. This is not only because technical scientists have dominated research on postharvest problems, but also because political pressures have encouraged high levels of government intervention in grain-handling systems. Political concerns for food security and rural welfare have encouraged the spread of confusion between social welfare goals and technical mechanisms needed to ensure efficient postharvest practices. Price penalties for undesirable practices have had to compete with guaranteed income and price stabilisation goals that, over time, erode the incentive structure needed to encourage new investment and adoption of improved postharvest technologies. Where appropriate technologies were found not to exist, the same inadequate set of incentives for adoption also thwarted research, by encouraging under-investment in the technology generation process. Consequently, the range of postharvest technologies available to farmers and grain merchants in the humid tropics has often been the result of poor adaptation of equipment not designed for the low annual throughputs and organisational problems associated with a cereals sector dominated by small farmers and poor infrastructural support mechanisms.

In the years ahead, a thoroughgoing reorientation of research and administration is needed in grains postharvest handling, storage, and transport in the humid tropics. The potential benefits of involving the private sector should be seriously assessed. Policies that reflect a more rational set of incentives need to be identified and enacted. Postharvest researchers must redirect more of their resources and energies to changing policies that are inimical to good postharvest practices. This will result in a reallocation of research resources from technology generation research to policy analysis. At a broader level, however, it also implies, *a priori*, a shift in research resources from problems of food production to those of postharvest grains handling, transport, storage, processing, and distribution in the humid tropics.

Closing Remarks

A.W. Blewitt *

I WELCOME the opportunity to make some concluding remarks on this excellent seminar on technological change in the postharvest handling and transportation of grains. This meeting represents a major development by facilitating dialogue among physical scientists, economists, sociologists, and end users on this complex and important topic.

Meetings such as this are an important element in assisting ACIAR to determine priorities for collaborative research and in looking at ways to make the beneficial results of research conducive to adoption and application.

The topic of this seminar is a very timely development as far as ACIAR's collaborative agricultural research program in this region is concerned. ACIAR was established in mid 1982 and represented an important innovation in Australia's development assistance policy. It was the first attempt to dedicate a single organisation to mobilising Australia's agricultural research capacity to work in collaboration with partner scientists in developing countries, with a particular emphasis on this region.

The Grain Storage Research Program was one of the earliest of the Centre's programs to become operational and this essentially reflected the priority given to improving grain storage technology in the region, due to the substantial losses occurring in the postharvest area. A package of research projects aimed at identifying and seeking solutions to grain storage problems has now been operating for three years. Thus, we and our collaborating partners in the region were pleased to support this seminar on technological change in postharvest handling and transportation of grains to bring together specialists from a number of disciplines to review principles, experience to-date, and future strategies for selecting and adopting appropriate technology in the postharvest sector.

The seminar discussed in a frank and open way the dynamic issues relevant to technological change, and in a realistic way took account of the often competing economic, technical, sociological, commercial, and government policy questions affecting the acceptability of technology options. The bottom line objective for us concerns the commercial acceptance and adoption of technology that is appropriate to the countries in the region. Further, in the final analysis, ACIAR will be evaluated on the extent to which its sponsored research results are adopted.

I was pleased to hear the emphasis given to taking account of mechanisms for the application of technological innovations very early in the research process. While ACIAR has no formal charter to become involved in extension, it does have a responsibility to work with its collaborators in designing projects that are conducive to application for the benefit of people in developing countries. This is the ultimate target for an organisation such as ACIAR and it is now our policy to question the future applicability of findings at the design stage of a project.

It is important that the findings and recommendations of this seminar be used to guide future discussion and processes for evaluating the impact of technological

* ACIAR, G.P.O. Box 1571, Canberra, A.C.T. 2601.

change in the postharvest grain sector. We will therefore be giving emphasis to the early production of meeting proceedings.

On behalf of ACIAR, I would like to sincerely thank the co-organisers and sponsors of this international seminar on 'Technological Change in Postharvest Handling and Transportation of Grains in the Humid Tropics'. These are — the Department of Agriculture in Thailand and the ASEAN Food Handling Bureau (AFHB). These two organisations work closely with ACIAR in many areas, and this level of cooperation is essential if initiatives such as this seminar are to be effective.

While I am reluctant to refer to individuals because of the large number of contributors to the outstanding success of the seminar, I would like to mention three people who have been central to the organisation of the meeting.

- Mr Sriwai Singhagajen, Agricultural Engineering Branch, Department of Agriculture, Thailand
- Mr J.P. Mercader, AFHB, Malaysia
- Dr B.R. Champ, ACIAR, Canberra

I would also like to thank the efficient secretariat which worked very hard behind the scenes to service the seminar.

On behalf of the seminar co-organisers and participants, could I also express appreciation to Mr Pradit Kongkatong of the Mah Boonkrong Rice Mill Company for the excellent hospitality at the Mah Boonkrong Centre. It was certainly an experience for me to see a centre of that size distributing such a wide range of high quality foods so efficiently.

Finally, and most importantly, I must congratulate and thank all participants in the seminar for their contributions. The level of audience participation in discussions was very refreshing, and this is a tribute to you all. The experience and specialist skills which you all shared with the meeting resulted in very successful dialogue and a better understanding of the complex physical, economic, and policy issues central to this important topic. While the formal seminar has now concluded, I am sure that the nature of the discussion on many of the issues identified at this meeting will help to sharpen future exchanges on this broad topic.

Mr Chairman, ladies and gentlemen, I now declare this seminar closed.

PARTICIPANTS

Australia

Mr T. Adamczak, Professional Officer, Department of Food Science & Technology, University of New South Wales, P.O. Box 1, Kensington, NSW 2033.

Mr J.H. Baird, Rice Consultant, 44 Mossman Court, Noosa Heads, Qld 4567.

Dr M. Bengston, Deputy Director, Entomology Branch, Queensland Department of Primary Industries, Meiers Road, Indooroopilly, Qld 4068.

Mr A.W. Blewitt, Centre Secretary, ACIAR, G.P.O. Box 1571, Canberra, ACT 2601.

Mr L.D. Bramall, Technical Development Manager, Rice-growers' Co-operative Ltd, P.O. Box 561, Leeton, NSW 2705.

Dr B.R. Champ, ACIAR Grain Storage Research Program, c/- CSIRO Division of Entomology, G.P.O. Box 1700, Canberra, ACT 2601.

Dr R.H. Driscoll, Department of Food Science & Technology, University of New South Wales, P.O. Box 1, Kensington, NSW 2033.

Dr B. Fegan, School of Behavioural Science, Macquarie University, North Ryde, NSW 2113.

Mr J. van S. Graver, CSIRO Division of Entomology, G.P.O. Box 1700, Canberra, ACT 2601.

Mr B. Hansen, SAGRIC International, G.P.O. Box 1671, Adelaide, SA 5001.

Mr E. Highley, ACIAR, G.P.O. Box 1571, Canberra, ACT 2601.

Mr W. Horrigan, Chief Entomologist, Export Inspection Service, Department of Primary Industry, Queen Victoria Terrace, Canberra, ACT 2600.

Mr B. Lee, Communications Coordinator, ACIAR, P.O. Box 1571, Canberra, ACT 2601.

Professor R.K. Lindner, School of Agriculture, University of Western Australia, Nedlands, WA.

Dr T.G. MacAulay, Department of Agricultural Economics and Business Management, University of New England, Armidale, NSW 2351.

Dr R.R. Piggott, Department of Agricultural Economics and Business Management, University of New England, Armidale, NSW 2351.

Dr J. Quilkey, Chairman, School of Agriculture, La Trobe University, Bundoora, Vic. 3083.

Dr J. Remenyi, Research Program Coordinator, ACIAR, G.P.O. Box 1571, Canberra, ACT 2601.

Dr G.J. Ryland, Economic Consultant, P.O. Box 114, Glen Osmond, SA 5064.

Mr A.D. Wilson, 22 Fechner Avenue, Horsham, Vic. 3400.

Bangladesh

Dr M.A. Jabbar, Bangladesh Agricultural University, Mymensingh.

Indonesia

Mr Hadi K. Purwadaria, Department of Agricultural Engineering, Bogor Agricultural University, Campus IPB Darmaga, P.O. Box 122, Bogor.

Dr Ticke Setiadi, Center for Research and Development, BULOG, Jl Gatot Subroto 49, Jakarta-Selatan.

Dr Mulyo Sidik, Head, Food Information and Technical Cooperation Center, BULOG, Jalan Gatot Subroto 49, Jakarta, Indonesia.

Mr Chrisman Silitonga, Agricultural Economist, BULOG, Jalan Gatot Subroto 49, Jakarta, Indonesia.

Mr B. Sugianto, Director, Directorate of Food Crops Economics and Processing, Jln Raya Ragunan 15, Jakarta, Indonesia.

Italy

Mr J.F. Robayo, FAO, Rome.

Japan

Mr H. Miyagoshi, Plant Protection Division — International, Sumitomo Chemical Co. Ltd, 15-5 Chome, Kitahama, Higashi-ku, Osaka 541.

Mr K. Tsuda, Plant Protection Division — International, Sumitomo Chemical Co. Ltd, 15-5 Chome, Kitahama, Higashi-ku, Osaka 541.

Malaysia

- Mr Abdullah Ali**, Senior Research Officer, MARDI, P.O. Box 105, 05710, Alor Setar, Kedah.
- Mr Y.F. Check**, Kumpulan Chemineer Eng. Co. Ltd, 12A Jalan SS2/61, 47300, Petaling Jaya, Selangor.
- Dr Chew-Tek Ann**, Department of Agricultural Economics, UPM, 43400, Serdang, Selangor.
- Mr Lim Hong Yang**, Kumpulan Chemical Engineering Co. Ltd, 12A Jalan ss2/61, 47300 Petaling Jaya, Selangor.
- Mr Loo Kau Fa**, Chief Engineer, Lembaga Padi dan Beras Negara, P.O. Box 108, Kuala Lumpur.
- Mr Ahmad Ilham Bin Hj. Abdul Samad**, Director, Planning and Research, LPN, G.P.O. Box 108, Kuala Lumpur.
- Mr Awang Sham B. Amit**, Complex Manager, LPN, Simpang Empag, Kangkong, Alor Setar, Kedah.
- Mr Azman Hassan**, Faculty of Economics & Management, UPM, 43400, Serdang, Selangor.
- Mr Haji Mohd Sahim Bin Haji Said**, Senior LPN Complex Manager, Ulu Tirum Buruk, Selangor.
- Mr Haji Ramli Bin Mohd Zim**, Deputy LPN State Officer, Kedah.
- Miss Emily Leong**, AFHB, Level 5, F13 and 14, Damansara Town Centre, 50490 Kuala Lumpur.
- Dr Mohd Ghazali Mohayidin**, Faculty of Economics & Management, UPM, 43400, Serdang, Selangor.
- Mr J.P. Mercader**, Projects Officer, AFHB, Level 5, F13 and 14, Damansara Town Centre, 50490 Kuala Lumpur.
- Mr Omar Bin Yob**, c/- Economics Division, Department of Agriculture, G.P.O. Box 1671, Adelaide, South Australia 5001.
- Dr Roslan A. Ghaffar**, Head, Department of Economics, UPM, 43400, Serdang, Selangor.
- Mr Saei Bin Dahi**, LPN State Officer, Perlis.
- Mr Sani Wahi**, State Director (Perlis), LPN, Bangunan Perkim, Kuala Lumpur.
- Mr Tan Chen Yan**, Sales Manager (Ag-Chem Division), Oriental Agricultural Products Sdn. Bhd., 40A, Jalan Telawi Lima, Taman Bangsar Baru, Off Jalan Marrof, 59100 Kuala Lumpur.
- Mrs Jean Sambhi**, Admin. Assistant to ACIAR, Australian High Commission, G.P.O. Box 921, Kuala Lumpur.
- Mr Shaharuddin Hj. Haron**, Director-General, LPN, G.P.O. Box 108, Kuala Lumpur.
- Mr Tan Boon Kiat**, Oriental Agricultural Products Sdn. Bhd., 40A Jalan Telawi Lima, Taman Bangsar Baru, Off Jalan Marrof, 59100 Kuala Lumpur.
- Mr Abdul Rahim Muda**, Senior Research Officer, Food Technology Division, G.P.O. Box 12301, Kuala Lumpur.

- Dr Sahak Mamat**, Lecturer and Head, Department of Natural Resource Economics, Universiti Pertanian Malaysia, 43400, Serdang, Selangor.
- Mr Dhiauddin Mohd Nour/Jantan**, Coordinator, Food Technology Division, MARDI, G.P.O. Box 12301, Kuala Lumpur.
- Mr Shafic Bin Muda**, LPN Complex, Jerlun, Alor Setar, Kedah.

Nepal

- Mr Badri Prasad Sitoula**, Seed Division, Agricultural Input Corporation, Central Office, Kathmandu.
- Mr J. Gwinner**, Cereal Seed Production Project, GTZ, P.O. Box 1451, Kathmandu.
- Mr Laxheshwar Yadau**, Agricultural Input Corporation, Central Office, Kathmandu.

Philippines

- Ms Redia N. Atienaz**, Farm Resources & Systems Research Department, PCARRD, Los Baños, Laguna.
- Mr Leodegario R. Bascos Jr.**, National Food Authority, 101 E. Rodriguez Sr. Avenue, Quezon City.
- Mr Edwin Benigno**, National Crop Protection Center, UPLB, College, Laguna.
- Mr Anselmo S. Cabigan**, National Food Authority, 101 E. Rodriguez Sr. Avenue, Quezon City.
- Mr Amnar Coranich**, Technical Team Member, ASEAN Crops Post-Harvest Programme, 3rd Floor, FTI Administration Building, Taguig, Metro Manila.
- Dr Emma S. Data**, Associate Professor, Postharvest Technology Section, Philippine Root Crop Research & Training Center, VISCA, 8 Lourdes Street, Pasay City.
- Dr Bart Duff**, Agricultural Economist, IRRI, P.O. Box 933, Manila.
- Mr Antonio S. Frio**, ASEAN Crops Post-Harvest Programme, 3rd Floor, FTI Administration Building, Taguig, Metro Manila.
- Mr Leonides S. Halos**, Engineer, Agricultural Engineering Department, IRRI, P.O. Box 933, Manila.
- Mr Concepto Irigo**, National Food Authority, 101E Rodriguez Sr. Avenue, Quezon City.
- Dr Joseph F. Karpati**, Plant Protection Attache, USDA-APHIS-PPQ, American Embassy, Manila.
- Mr Alessandro A. Manilay**, Technical Team Member, ASEAN Crops Post-Harvest Programme, 3rd Floor, FTI Administration Building, Taguig, Metro Manila.
- Ms Adriano S. Marietta**, National Economic and Development Authority, Amber Avenue, Pasig, Metro Manila.

- Mr J.V. Moore**, Technical Team Leader, ASEAN Crops Post-Harvest Programme, 3rd Floor, FTI Administration Building, Taguig, Metro Manila.
- Ms Leonarda G. Nallana**, ACIAR Liaison Scientist, PCARRD, 2nd Floor, Miramar House, Manila Domestic Airport Road, Pasay City.
- Ms Relli C. Pableo**, Assistant Professor VI, Isabela State University, Echague, Isabela.
- Ms Gloria Picar**, Chief, Post-Harvest Systems Analysis Development Division, NAPHIRE, CLSU, Munoz, Nueva Ecija.
- Mr Vicente V. Racho**, Director for Public Affairs, Technical Research & Extension Directorate, National Food Authority, Matimyas Building, 101 E. Rodriguez Sr. Avenue, Quezon City.
- Mrs Perlina D. Sayaboc**, Acting Chief, Food Protection Division, NAPHIRE, CLSU, Munoz, Nueva Ecija.
- Mr Jerome F. Sison**, Chairman, Department of Agricultural Economics, College of Development Economics & Management, UPLB, College, Laguna.
- Dr Zenaida Toquero**, Visiting Scientist, SEARCA, P.O. Box 720 MCC, Makati, Rizal.
- Mr F. Tua**, Executive Director, NAPHIRE, CLSU, Munoz, Nueva Ecija.
- Mr Justin Tumaming**, NAPHIRE, CLSU, Munoz, Nueva Ecija.
- Mr Mauricio R. Valdez**, Chief, Research Division, Technical Research & Extension Directorate, National Food Authority, Matimyas Building, 101 E. Rodriguez Sr. Avenue, Quezon City.
- Singapore**
- Dr S.H. Ho**, Department of Zoology, National University of Singapore, Kent Ridge, Singapore.
- Dr Lau Tin Koon**, Managing Director, Oriental Agricultural Products Pty Ltd, 268 Orchard Road, Hex 13-10, Yen San Building, Singapore.
- Mr C.W. McCormac**, Program Officer (Economics), IDRC, Tanglin, P.O. Box 101, Singapore 9124.
- Mr S.J.S. Martin**, Industrial Marketing Manager, Seazone, Wellcome (Singapore) Pty Ltd, 33 Quality Road, Singapore 2261.
- Dr Dante de Padua**, Program Officer, IDRC, Tanglin, P.O. Box 101, Singapore 9124.
- Sri Lanka**
- Dr U.R. Sangakkara**, Faculty of Agriculture, University of Peradeniya, Peradeniya.
- Thailand**
- Dr Ampol Senanarong**, Deputy Director-General, Department of Agriculture, Bangkok, Bangkok 10900.
- Mr Apichai Sunchindah**, Liaison Scientist, ACIAR, P.O. Box 9-43, Bangkok, Bangkok 10900.
- Dr Apichart Chirattiyangkur**, Department of Agricultural Engineering, Kasetsart University, Bangkok.
- Mr Arun Anprasertporn**, SGS Far East Ltd, 994 Sukhumvit Road 55, Bangkok.
- Ms Arunsri Wongurai**, Seed and Postharvest Pathology Branch, Division of Plant Pathology and Microbiology, Department of Agriculture, Bangkok.
- Mr Banchaw Bhaholyotin**, Agricultural Machinery Centre, Kasetsart University, Kamphaengsaen Campus, Bangkok.
- Ms Boonluck Seetanun**, Planning and Technical Division, Department of Agriculture, Bangkok, Bangkok.
- Mr Boonterm Tiravatinprasert**, Faculty of Economics and Business Administration, Kasetsart University, Bangkok.
- Mr Chak Chakkaphak**, Agricultural Engineering Division, Department of Agriculture, Bangkok, Bangkok.
- Mr Chalerm Sukplang**, Pathumthani Agricultural Campus, Rangsit, Pathumthani.
- Mr Chalitaporn Chai**, Tai Sae Co. Ltd, 7th Floor, Sinthorn Building, 132 Wireless Road, Bangkok.
- Mr Chamlong Laparsathukool**, Plant Quarantine Sub-Agricultural Regulatory Division, Department of Agriculture, Bangkok, Bangkok.
- Mr Chatt Chamchong**, Department of Agricultural Science, Kasetsart University, Bangkok.
- Mr Chusak Charoonsawat**, Department of Foreign Trade, Sanamchai Road, Bangkok.
- Mr Chusak Chavapradit**, Agricultural Engineer, Storage and Processing Section, Agricultural Engineering Division, Department of Agriculture, Bangkok.
- Mrs Chutip Chanaseni**, Department of Agricultural Extension.
- Mr Chuwit Sukprakarn**, Entomologist, Entomology & Zoology Division, Department of Agriculture, Bangkok, Bangkok 10900.
- Mr Michael Crowther**, Bank for Agriculture and Agricultural Cooperatives, 469 Nakon Sawan Road, Bangkok.
- Ms Euay Singhakul**, Division of Agricultural Engineering, Department of Agriculture, Bangkok, Bangkok.
- Ms Marianne Flach**, FAO, Phra Atit Road, Bangkok.
- Mr Richard T.H. Heng**, Imtrade Co. Ltd, 4/11 Sukhumvit 33, Bangkok.
- Mr Hirun Anupong**, Faculty of Engineering, Cheng Mai University, Cheng Mai 50002.
- Dr S.G. Ilgantileke**, Associate Professor in Post-Harvest Technology, Asian Institute of

- Technology, P.O. Box 2754, Bangkok 10501.
- Mr Jessada Lapchotikan**, United Grain Co. Ltd, 51 Poochaosamingprai Road, Phrapradaeng, Samutprakan.
- Dr V.K. Jindal**, Associate Professor, Division of Agricultural & Food Engineering, Asian Institute of Technology, P.O. Box 2754, Bangkok 10501.
- Dr Juangjum Duangpatra**, Department of Agronomy, Faculty of Agriculture, Kasetsart University, Bangkok.
- Miss Kitiya Kitkuandee**, Rice Research Institute, Department of Agriculture, Bangkok, Bangkok 10900.
- Mr Panom Uyanontarak**, SGS Far East Co. Ltd, 994 Soi Thangior Sukhumvit 55 Prakhonong, Bangkok.
- Ms Petchara Preechakul**, King Mongkut's Institute of Technology, Bangkok.
- Mr Phachon Suevachee**, Department of Foreign Trade, Ministry of Commerce, Sanarm Chai Road, Bangkok 10200.
- Dr Pismai Srisukphrasert**, Chief, Research Administration Sub-Division, Field Crops Research Institute, Department of Agriculture, Bangkok 10900.
- Mr Pitoon Urairong**, Rice Research Institute, Department of Agriculture, Bangkok, Bangkok 10900.
- Ms Porntip Visarathanonth**, Stored Products Insect Research Branch, Department of Agriculture, Bangkok.
- Mr Prabhand Charoensuk**, United Silos and Service Co. Ltd, 51 Poochaosamingprai Road, Phrapradaeng, Samutprakan.
- Mr Pradit Kongkaton**, General Manager, Mah Boonkrong Rice Mill Co Ltd, 202-206 Mahaesak Road, Bangkok.
- Mr Pramuan Satarath**, Department of Agricultural Extension.
- Mr Prapard Chirapatsakun**, F.E. Zuelling (Bangkok) Ltd, 1 Silom Road, Bangkok.
- Ms Prisnar Siriacha**, Seed and Postharvest Pathology Branch, Division of Plant Pathology and Microbiology, Department of Agriculture, Bangkok.
- Dr Riksh Syamananda**, Deputy Director-General, Department of Agriculture, Bangkok, Bangkok 10900.
- Mr Samrit Chaiwanakupt**, Department of Agriculture, Bangkok, Bangkok.
- Mr Sanguan Chayutsahakij**, UFM, 51 Poochaosamingprai Road, Phrapradaeng, Samutprakan.
- Dr Sarun Wattanutchariya**, Department of Agricultural Economics, Kasetsart University, Bangkok, Bangkok.
- Miss Sasinath Saengwong**, Agri-business Section, Bank for Agriculture and Agricultural Co-operatives, 469 Nakornsawan Road, Dusit, Bangkok.
- Mr Sawang Sriprasert**, Riceland International, 38/17 Dejo-Surawong Road, Bangkok 10900.
- Mr Seubsak-Di Tachakapat**, U.S.S., 51 Poochaosamingprai Road, Phrapradaeng, Samutprakan.
- Mr Singh Amarnath**, Thai Hua (2511) Co. Ltd, 171 Soi Luehrit Jawraj Road, Bangkok.
- Mrs Siriporn Sindhusake**, Foreign Sub-division, Planning and Technical Division, Department of Agriculture, Bangkok.
- Dr Somchart Soponronnarit**, Asst. Professor, School of Energy and Materials, King Mongkut's Institute of Technology, Thonburi, Bangkok 10140.
- Mr Sompong Promsiri**, Bank of Asia, 295 Sri Phraya Road, Bangkok 10500.
- Mr Somsak Teerabetmanakul**, United Flour Milling Co. Ltd, 51 Poochaosamingprai Road, Phrapradaeng, Samutprakan.
- Mr Somyot Chirnakorn**, Agricultural Engineering Department, Kasetsart University, Kamphaengsaen, Nakorn Pathom 73140.
- Miss Sopawan Svetanaga**, Entomology and Zoology Division, Department of Agriculture, Phahonyothin Road, Bangkok 10900.
- Miss Sornkaew Benjawan**, Entomology and Zoology Division, Department of Agriculture, Phahonyothin Road, Bangkok 10900.
- Ms Srisuda Anusornpanich**, Rice Research Institute, Department of Agriculture, Bangkok.
- Mrs Sriwai Singhagajen**, Chief Storage & Processing Group, Agric. Engineering Division, Department of Agriculture, Bangkok, Bangkok 10900.
- Mr Suchin Denchakrawal**, Mah Boon Krong Rice Mill, 88 Moh 2 Bangadee, Tiyanont Road, Phatumthani.
- Dr Suchon Nimmannitaya**, Department of Food Science and Technology, Faculty of Agriculture, Chiang Mai University, Chiang Mai.
- Mr Sujin Suwankosit**, Soon Hua Seng Group (1983) Co. Ltd, 107 Moo 2 Tambol Bangsamaak, Bangpakong, Chachoengsao.
- Mrs Supang Lertsatchayarn**, Thai Maize and Produce Traders Association, Bangkok.
- Dr Supasark Limpiti**, Associate Professor, Department of Agronomy, Faculty of Agriculture, Chiang Mai University, Chiang Mai 50002.
- Miss Suphap Suntaranond**, Rice Research Institute, Department of Agriculture, Bangkok, Bangkok 10900.
- Mr Suphot Amphuprapha**, Department of Foreign Trade, Ministry of Commerce, Sanarm Chai Road, Bangkok.

- Mr Surachit Jamjod**, Cargill Seeds Ltd, 690 5th Floor, Choke Chai Building, Sukumvit Road, Bangkok.
- Mr Surendranath Thangavadivelu**, Asian Institute of Technology, P.O. Box 2054, Bangkok.
- Mrs Surpatee Imithuksa**, Agricultural Toxic Substances Division, Department of Agriculture, Bangkok.
- Suthep Phuratenondha**, Patumthani Agricultural Campus, Rungsit, Patumthani Province 12130.
- Mrs Suvabha Vetayanugul**, Marketing Organisation for Farmers, 101 Kampaengphet Road, Bangkok.
- Mr Tawan Thongmee**, UMC International Corporation, 177 Rasjwong Road, Bangkok.
- Ms Teeranuj Hiranpradist**, Maliwan Mansion, Phra Atit Road, Bangkok.
- Mr Thitiphone Sankhariksha**, Gold Coin Ltd, F.E. Zuellir, 1-7 Silom Road, Bangkok.
- Mr Thivavarnvongs Thavachai**, Department of Agricultural Engineering, Khon Kaen University, Khon Kaen 40002.
- Mr Tiewsomboonkit**, Faculty of Agricultural Technology, King Mongkut's Institute of Technology, Bangkok.
- Mr Veara Loha**, King Mongkut's Institute of Technology, Thonburi, Bangkok.
- Mr Viboon Thepent**, Storage and Processing Section, Division of Agricultural Engineering, Department of Agriculture, Bangkokhen, Bangkok 10900.
- Dr Vichian Hengsawad**, Associate Professor, Faculty of Agriculture, Chiang Mai University, Chiang Mai 50002.
- Mr Vijai Nopamornbodi**, National Agricultural Research Office, Department of Agriculture, Bangkok.
- Mrs Vilipron Noparatankailas**, King Mongkut's Institute of Technology, Thonburi 10140.
- Ms Warunee Tia**, King Mongkut's Institute of Technology, Thonburi, Rajburana, Bangmod.
- Mr Wichai Supanimitrakul**, Manager, Industrial Division, Wellcome Thailand Ltd, 64/1-4 Pan Road, Silom, Bangkok 10500.
- Mr Winai Hansasiripot**, Senior Sales Representative, Wellcome Thailand Ltd, Industrial Division, 64/1-4 Pan Road, Silom, Bangkok 10500.
- Mr Windi Hansasiripot**, Wellcome Thailand Co. Ltd, 64/1-4 Pan Road, Silom, Bangkok.
- Mr Winit Chinsuwan**, Faculty of Engineering, Khon Kaen University, Khon Kaen 40002.
- Mr Yongyuth Puechkamutr**, Division of Agricultural and Food Engineering, Asian Institute of Technology, P.O. Box 2754, Bangkok.
- United Kingdom**
- Mr P.H. Giles**, Post-Harvest Technologist, Storage Department, Tropical Development & Research Institute, London Road, Slough, Berkshire SL3 7HL.
- United States of America**
- Professor Won W. Koo**, Agricultural Economics, Morvill Hall, North Dakota State University of Agriculture and Applied Science, P.O. Box 5636, Fargo, North Dakota 58105.

ACIAR PROCEEDINGS SERIES

- No. 1. Proceedings of the Eastern Africa-ACIAR consultation on agricultural research, Nairobi, Kenya, 19-22 July 1983. J.G. Ryan (ed.), 241 p., 1984.
- No. 2. Proceedings of the international workshop on soils, Townsville, Qld., Australia, 12-16 September 1983. E.T. Craswell and R.E. Isbell (ed.), 189 p., 1984.
- No. 3. Shrub legume research in Indonesia and Australia; proceedings of an international workshop, Ciawi-Bogor, Indonesia, 2 February 1984. E.T. Craswell and Budi Tangendjaja (ed.), 42 p., 1985.
- No. 4. Proceedings of the Nigeria-Australia seminar on collaborative agricultural research, Shika, Nigeria, 14-15 November 1983. S. Nuru and J.G. Ryan (ed.), 145 p., 1985.
- No. 5. Evaluation of large ruminants for the tropics; proceedings of an international workshop held at CSIRO, Rockhampton, Queensland, Australia, 19-23 March 1984. J.W. Copland (ed.), 178 p., 1985.
- No. 6. Soil erosion management: proceedings of a workshop held at PCARRD, Los Baños, Philippines, 3-5 December 1984. E.T. Craswell, J.V. Remenyi, and L.G. Nallana (ed.), 132 p., 1985.
- No. 7. Goat production and research in the tropics: proceedings of a workshop held at the University of Queensland, Brisbane, Australia, 6-8 February 1984. J.W. Copland (ed.), 118 p., 1985.
- No. 8. Tropical legume improvement: proceedings of a Thailand/ACIAR planning and coordination workshop, Bangkok, 10-12 October 1983. G.J. Persley (ed.), 77 p., 1985.
- No. 9. Smallholder rubber production and policies: proceedings of an international workshop held at the University of Adelaide, South Australia, 18-20 February 1985. 151 p., 1985.
- No. 10. Draught animal power for production: proceedings of an international workshop held at James Cook University, Townsville, Qld., Australia, 10-16 July 1985. J.W. Copland (ed.), 170 p., 1985.
- No. 11. Agricultural systems research for developing countries: proceedings of an international workshop held at Hawkesbury Agricultural College, Richmond, NSW, Australia, 12-15 May 1985. J.V. Remenyi (ed.), 189 p., 1985.
- No. 12. Forages in Southeast Asian and South Pacific agriculture: proceedings of an international workshop held at Cisarua, Indonesia, 19-23 August 1985. G.J. Blair, D.A. Ivory, and T.R. Evans (ed.), 202 p., 1986.
- No. 13. Bacterial Wilt Disease in Asia and the South Pacific: proceedings of an international workshop held at PCARRD, Los Baños, Philippines, 8-10 October 1985. G.J. Persley (ed.), 145 p., 1986.
- No. 14. Pesticides and humid tropical grain storage systems: proceedings of an international seminar, Manila, Philippines, 27-30 May 1985. B.R. Champ and E. Highley (ed.), 364 p., 1986.
- No. 15. Preserving grain quality by aeration and in-store drying: proceedings of an international seminar held at Kuala Lumpur, Malaysia, 9-11 October 1985. B.R. Champ and E. Highley (ed.), 250 p., 1986.
- No. 16. Australian acacias in developing countries: proceedings of an international workshop held at the Forestry Training Centre, Gympie, Qld., Australia, 4-7 August 1986. John W. Turnbull (ed.), 196 p., 1987.
- No. 17. Ticks and tick-borne diseases: proceedings of an international workshop on ecology of ticks and epidemiology of tick-borne diseases, held at Nyanga, Zimbabwe, 17-21 February 1986. R.W. Sutherst (ed.), 159 p., 1987.
- No. 18. Food legume improvement for Asian farming systems: proceedings of a workshop held at Khon Kaen, Thailand, 1-5 September 1986. In press.