



AgEcon SEARCH
RESEARCH IN AGRICULTURAL & APPLIED ECONOMICS

The World's Largest Open Access Agricultural & Applied Economics Digital Library

This document is discoverable and free to researchers across the globe due to the work of AgEcon Search.

Help ensure our sustainability.

Give to AgEcon Search

AgEcon Search
<http://ageconsearch.umn.edu>
aesearch@umn.edu

*Papers downloaded from **AgEcon Search** may be used for non-commercial purposes and personal study only. No other use, including posting to another Internet site, is permitted without permission from the copyright owner (not AgEcon Search), or as allowed under the provisions of Fair Use, U.S. Copyright Act, Title 17 U.S.C.*

Decision support tools for crop plant germplasm maintenance in PNG

David Godden*, Santhi Wicks*, John Kennedy** and Rosa Kambuou***

42nd Annual Conference of the
Australian Agricultural and Resource Economics Society
Armidale NSW
19-21 January 1998

* Department of Agricultural Economics, A04, University of Sydney NSW 2006

** School of Business, La Trobe University, Bundoora VIC 3083

*** National Agricultural Research Institute, Port Moresby NCD, Papua New Guinea

The research reported in this paper was financially supported by the Australian Centre for International Agricultural Research.

Abstract

Papua New Guinea has major ex situ field collections of plant genetic material in its staple food crops (aibika, banana, cassava, sweet potato, taro, yams). With limited germplasm conservation resources available, difficult choices must be made as to which plants to maintain. The objective of this study is to provide a better basis for evaluating the efficient allocation of resources to plant germplasm conservation of food staples in PNG. Tools that could be employed to determine an efficient allocation include cost budgeting (through spreadsheets), and linear or dynamic programming. Cost budgets were developed to estimate the total cost of maintaining current sweet potato, taro, banana and aibika germplasm collections. Budgets are integrated through the key variables to produce a master spreadsheet. Key variables including (i) the number of accessions, (ii) the number of plants per accession, (iii) the planting density or (iv) the length of the reproduction cycle may be adjusted to investigate the effects on total costs of alternative strategies for maintaining collections. It is also planned to use linear and dynamic programming to identify the optimal allocation of resources subject to given constraints.

keywords: plant germplasm conservation

1. Introduction

Papua New Guinea has major ex situ field collections of plant genetic material in its staple food crops (aibika, banana, cassava, sweet potato, taro, yams). With limited germplasm conservation resources available, difficult choices must be made as to which plants to maintain. The objective of this study is to provide a better basis for evaluating the efficient allocation of resources to plant germplasm conservation of food staples in PNG. Kambuou (1995) and Godden and Kambuou (1996) outlined the food production system in PNG, and the status of the country's crop plant germplasm collections. Godden, Kennedy and Kambuou (1997) outlined an economic approach to evaluating plant germplasm conservation; this material is briefly reviewed in section 2 of this paper. Three broad approaches to the empirical analysis of germplasm conservation are considered in this paper: cost budgeting (through spreadsheets) (section 3), and two mathematical programming models (section 4).

2. Modelling Germplasm Collections¹

2.1 Conservation, evaluation and breeding

Integration of models of conservation of germplasm conservation and plant breeding may be illustrated as in Figure 1. Panel A depicts conventional plant breeding activities in which plant breeders attempt to develop improved plant varieties using human and physical capital, existing plant material, and possibly develop new plant material ("genetic engineering"). An important component of this activity is the utilisation of genetic material that confers advantages to plants in terms of more efficient use of nutrients or water, better adaptation to environmental stresses (temperature (extreme heat or extreme cold), drought) or scourges (pests, diseases or weeds). The utilisation of superior genetic material requires that it be identified and "stored" for future use.

Panel C might be thought of as a museum of plant varieties. Use of this museum requires that the varieties within this museum be catalogued and evaluated—the "germplasm evaluation" effort (panel B). Newly discovered varieties must also be evaluated and added to the collection. The number of varieties successfully maintained in the museum collection (from panel C), the number of new discoveries, and the funding available for germplasm evaluation, determine the number of varieties that may be evaluated in a given period. The information obtained on these varieties adds to the accumulated knowledge of varietal characteristics which also contributes to the decision as to how many varieties to maintain (panel C).

Panel C is represents the "germplasm conservation" activity. The key variables of this activity are the type of material to be conserved (e.g. taro), the technology available to effect this conservation (e.g. field collections, tissue culture, seed collections), and the funding available which determines—in conjunction with the conservation technology chosen—the required resources of land, labour and supplies. Given the conservation technology and resource constraints, the collection size may be determined, and this collection size partitioned into the number of varieties to be conserved and the number of replicates of each variety. The interaction of the number of individual varieties chosen to maintain and the numbers of replicates of these varieties, together with environmental conditions, determines the actual number of varieties successfully maintained each period.

¹ cf. Godden, Kennedy and Kambuou (1997).

Panels A and B comprise the maintenance and documentation of accessions held in the “museum” of plant varieties, and this information is valuable for scientific purposes. However, the principal *economic* reason for maintaining such collections is that germplasm maintained within them may be used in selection and/or breeding programmes to improve currently utilised varieties, whether for subsistence or commercial purposes. The number of varieties maintained (panel A) and the accumulated knowledge about these varieties (panel B) contribute to the production process for new varieties—the “germplasm utilisation” process (panel C). The degree to which new germplasm can be incorporated in economically-useful varieties not only depends on the number of varieties conserved and knowledge about these varieties, but also the funding of the plant breeding effort. Additional factors affecting the plant breeding effort are the environmental and economic conditions affecting plant production—e.g. the effect of existing or newly emerging pests and diseases, and existing or potential economic conditions affecting the value of products from particular varieties or their costs of production. Ultimately, the value of output of particular plant kinds influences the resources society is prepared to commit to preserving plant collections, additional to resources society might be prepared to commit to maintain such collections for purely scientific purposes.

The decision process represented in Figure 1 might be implemented for a single plant kind such as taro. The general framework for obtaining numerical solutions to this problem for a single crop is outlined in the next section. In the context of PNG agriculture, it is proposed to ultimately permit the integration of the consideration of all the plant kinds in which PNG has major plant germplasm collections, with an initial focus on aibika, banana, sweet potato and taro.

2.2 Germplasm conservation options

If conservation funds are unlimited, then the best strategy is to conserve all known plant germplasm, both *ex situ* (“genebanks”) and natural habitats (*in situ*) to conserve currently unidentified plant germplasm (cf. pathway 1 in Figure 2).

If conservation funds are limited, however, the decision problem is much more difficult. If estimating the benefits of germplasm conservation is impossible, it is at least possible to estimate the costs of various methods of germplasm conservation, and the costs of different sized collections. It would then be necessary to develop a procedure to reconcile the known estimated costs of germplasm conservation against beliefs about the value of conserving various plant kinds, numbers of accessions and methods of conservation (cf. pathway 2 in Figure 2).

If only scientific assessment of the future value of germplasm is possible, then it may be possible to rank the importance of germplasm material, and conserve the highest ranked material until the budget constraint is reached (Figure 2, pathway 3).

Economic analysis of optimal investment in germplasm preservation requires estimates of the benefits of this storage as well as the costs of such preservation (cf. pathway 4 in Figure 2). The value of germplasm collections depends on the future incorporation of the genetic material into commercial varieties via plant breeding, and estimation of this value is not a trivial problem. Assessing the value of germplasm collections requires being able to relate existing conserved germplasm to future advances in plant breeding. Because, by definition, these advances occur in the future, a model is required to forecast the (approximate) future value of existing collections.

2.3 Germplasm conservation—a simple production model

The inputs in a plant germplasm conservation process are principally labour, and physical and human capital. In the case of in situ or field conservation of plant germplasm, land is also important. A simplified model of plant germplasm conservation is presented in Figure 3 in terms of labour, and combined physical and human capital. Consider options for maintaining a stock of plant germplasm varieties equal to N . These may be, for example, labour intensive such as field collections of growing material (e.g. point A in Figure 3) or capital intensive such as controlled environment seed storage or tissue culture (e.g. at B in Figure 3). In PNG's case, labour is relatively cheap compared to human and physical capital, and plant germplasm is generally maintained as field collections. There are some exceptions to this generalisation, but these exceptions involve the use of external aid funds to relax the capital constraint. Some experimentation is currently proceeding to investigate the feasibility of lower-cost tissue culture storage—e.g. to develop an intermediate technology like C (Figure 3)—by extending the storage life of tissue culture specimens.

In section 3 of the paper is reported an analysis of the costs of plant germplasm conservation which is equivalent to estimating point A on isoquant N for the given numbers of accessions in PNG's various aibika, banana, sweet potato and taro germplasm collections. Additionally, this modelling is extended to show the consequences of varying both the size of the collections and the technologies used to maintain them. There is an additional, initial set of estimates of the costs of "high capital" technologies of maintaining living plants using tissue culture (corresponding to point B on isoquant N).

3. Germplasm Collection Costs

Detailed costings of crop plant collections were undertaken for two reasons. Firstly, constructing cost budgets in spreadsheet form enables managers to undertake scenario analyses of varying the form of germplasm collections. Such analyses enable managers to experiment with the collections

3.1 Current Collections

Most food crops are currently maintained in Papua New Guinea (PNG) as vegetative collections, though there are moves towards maintenance using in vitro techniques. The four crops analysed are maintained in different locations. Sweet potato is maintained in Rabaul at the Lowland Agricultural Experimental Station (LAES), in Kainantu at the Highland Agricultural Experimental Station (HAES) and in Tambul at the High-Altitude Agricultural Experiment Station. The banana and aibika germplasm collections are currently held at Laloki Agricultural Research Stations (LARS) near Port Moresby, and taro is maintained in Lae at Bubia Agricultural Research Centre (BARC) (Godden and Kambuou, 1996).

Maintenance of germplasm collections involves three distinct processes:

- (i) Museum collections, which are established for long term germplasm maintenance. They may be used to replace cultivars lost as a result of uncontrollable environmental disasters, and are useful for breeding programs (e.g. taro breeding program).
- (ii) The breeding program, which is necessary to develop superior varieties for distribution to farmers.
- (iii) Field evaluation, which is conducted to identify and record the characteristics, of cultivars collected or bred to determine if these are superior varieties or replicates of existing

cultivars. New cultivars are superior if they display characteristics preferred by farmers in specific region(s). During field evaluation it is important to determine if new varieties are suitable for distribution to farmers.

Table 1 which outlines the key collections currently maintained at research stations in PNG, shows that germplasm collections may be combinations of the processes listed above. Each collection contains a museum and field evaluation collection. Taro is the only crop where breeding is conducted. Taro and sweet potato germplasm maintained in research stations contain a museum collection. However, the aibika and banana germplasm are maintained in a collection used for long term maintenance and evaluation: museum and field evaluation collection. Because sweet potato plants reproduce spontaneously, PNG officers collect and evaluate plant materials from farmers fields, markets and vegetable gardens to identify potentially different cultivars: these are called field evaluation collections. As previously indicated breeding and evaluation is only conducted for the taro germplasm collection: these processes are compacted to form the breeding and field evaluation collections.

Four general station activities are conducted to maintain the collections: land preparation, planting and replanting, crop maintenance and harvesting. Land preparation, which includes slashing, ploughing, harrowing and field marking are undertaken at the beginning of the cycle. Planting follows land preparation and if plant material deteriorates it may be discarded or, rescued and replanted later. If plants are discarded, infilling is conducted and plant material is transplanted from the old gardens. Crop maintenance includes general crop maintenance such as weeding (both hand and machine weeding), and application of fertilisers, insecticides and fungicides. Harvesting is conducted at the end of the reproduction cycle, preceding establishment of the new garden to ensure that plant material is safely transferred. Harvesting is conducted following land preparation of the new garden, ensuring that plant material is safely transferred.

3.1.1 Taro

PNG farmers generally propagate taro plant material vegetatively for their own crops, as the plants are unlikely to reproduce from seed. While most taro varieties produce an inflorescence, flowering is irregular and seed production is limited: hence sexual reproduction is extremely limited. These problems are attributed to three factors: failure of the reproduction process, inadequate plant structure and unsuitable environmental conditions. The reproduction process fails if there is triploidy or other irregularities in meiosis. Plant structure is inadequate if stigmas are non-receptive, female flowers are sterile, male reproductive organs are sterile, pollen is sterile, plants are weak, inflorescence are is weak or underdeveloped, inflorescence are abnormal, or genetic structure is incomplete. Plant fertility is irregular if flowers have abnormal floral structures, underdeveloped inflorescences, insufficient pollen production or weak flower odour (required to attract insects for pollination) hindering sexual reproduction. Environmental factors limiting sexual reproduction include heavy rain, dry winds, high concentration of herbicides or pesticides, extreme concentration of nitrogen in the soil, disease infection, mechanical damage of the plant, taro beetle and other insect damage, extreme doses of chemicals that induce flowering. Even when flowers seed, their seeds are unlikely to germinate and develop into mature plants (Ivancic et al. 1995, p.76).

Taro germplasm is currently maintained at Bubia Agricultural Experiment Station (BARC) both as a museum collection, and as breeding and field evaluation collection. Accessions selected for use in breeding and field evaluation were selected from the museum collection and the breeding population. The museum germplasm collection was initially established using plant material from farmers vegetable gardens, household gardens, forests and the market place (see Figure 4). The breeding population was established using key accessions from collections in Thailand and PNG

that are partially resistant to taro leaf blight (TLB) or display desirable qualities (Risimeri 1997, pers. comm.). Taro breeding conducted in BARC is focused on development of superior varieties that are resistant to TLB display high yielding characteristics and satisfy local taste preferences. TLB is a fungal disease caused by *Phytophthora* (or *Phytophthera*) *colocasiae*. The first symptoms include small water spots on the leaves upper surface or bright orange to red-purplish liquid spots on the leaves surface that form black or brown pellets. Symptoms are apparent and the effects on yields are measurable.

The interactions between the taro museum collection and the breeding and field evaluation germplasm collections maintained at BARC are shown in Figure 4. The process is initiated with establishment of collections one and two as vegetative plant material in the museum collection. Varieties are selected and manually cross pollinated. Seeds are collected and germinated in pots within the nursery (glass house). Plants are thinned and transplanted before establishing in the field, where evaluation is initiated. Cultivars are maintained as vegetative material and transplanted to new gardens at completion of the reproduction cycle (see Figure 5). There are four stages for field evaluation: the initial field evaluation, secondary evaluation (preliminary selection), re-evaluation and the formal evaluation. At each evaluation process researchers must assess if the potential new cultivars display desirable characteristics. If the answer is positive further evaluations are conducted, while if it is negative the cultivar is discarded. Before the final evaluation is conducted it must be determined if there is adequate plant material for the “formal evaluation”; replication occurs where necessary. An independent group of individuals were selected for taste testing. In the formal evaluation a panel of farmers is selected to taste test the new varieties, to see if they display the desired qualities. Depending on the results varieties may be discarded, used in further breeding efforts or distributed to farmers. As this program is in its initial stages, scientists are still to identify cultivars that are suitable for distribution.

3.1.2 Sweet Potato

The key sweet potato germplasm collections are maintained at three research centres: LAES, HAES and the High-Altitude Agricultural Experiment Station. Field evaluation collections are maintained at all research centres. Varieties currently maintained at the HAES and LAES are environment specific, hence accessions are considerably different between these collections. Accessions maintained at the High-Altitude Agricultural Experiment Station were selected and established using cultivars from the sweet potato field evaluation collection at HAES.

Sweet potato germplasm collections are maintained using two different land formation techniques, namely ridges and mounds. Figure 6 shows a mound that contains three stations and five plants. Collections maintained on ridges are established on a plot, each ridge contains some stations and plants, as shown in Figure 7. Kanua and Rangaii (1987) suggested that the principal reason for establishing mounds on farms is to concentrate nitrogen and potassium nutrients around the plant's primary roots and maximise yields. Officers from PNG research stations suggest that this technique is preferred for long term maintenance of germplasm collections (i.e. museum collections) as runners may be more restricted. The total cost per reproduction cycle is believed to be lower for establishment of ridges relative to mounds (Guaf 1997, pers. comm.). If the depreciation cost of machinery is included in this estimation, the total cost of developed ridges is greater than for mounds.

Collections maintained at LAES include the museum germplasm collection established on mounds, and the field evaluation collection on ridges (see Figure 6 and 7 respectively). The museum collection is maintained with one accession per mound, while the field evaluation collection occupies an area separated into plots with one accession per plot.

The sweet potato museum collection at HAES was established in 1987 and activities conducted for this collection are limited to maintenance. The field evaluation collection was established on mounds (Figure 8) because tractors were unavailable for preparation of ridges. This collection is divided into large and small working collections. The large working collection comprises four groups:

- . pure accessions—varieties remaining from when the collection was initially established.
- . mixed accessions number one—established from sexual reproduction of two pure accessions.
- . mixed accessions number two—established from sexual reproduction of three pure accessions, and
- . mixed accessions number three—established from sexual reproduction of four pure accessions.

The collections are maintained on an area sub-divided into a series of plots: an accession is maintained in each plot and there are several mounds per plot (Figure 8).

The sweet potato field evaluation collection at the High-Altitude Agricultural Experimental Station was developed to determine if maintenance of sweet potato in higher altitudes increases the length of the reproduction cycle. These varieties are replicates of accessions maintained in the field evaluation collection at HAES. Varieties are established using different mounds. This is illustrated in Figure 9 where variety 1 (V1) and variety 2 (V2) are maintained using separate mounds. “TR” is a traditional variety used by farmers in the highlands regions of PNG and is maintained on numerous plots at selected intervals. The traditional variety is used as a comparison of current varieties with traditional varieties; these plants are possibly established in different locations when the collection is replanted.

Interactions between the museum and field evaluation collections maintained at LAES and HAES are illustrated in Figure 10. The museum collection was established using plant materials found in farmers’ vegetable gardens, household gardens, forests and the market place. Once established, researchers proceed to identify and record new possibly superior varieties in three field evaluation processes: initial field evaluation, secondary field evaluation and final field evaluation. At all stages officers identify if the variety is currently maintained in any collections and determine if the variety displays desired qualities. Before the final field evaluation, plant material is replicated. Proceeding the final evaluation officers determine whether the variety is suitable for distribution, or whether further evaluation is necessary.

3.1.3 Aibika and Banana

A ‘museum and field evaluation’ collection is maintained for both the aibika and banana germplasm (see Table 1). Because these collections are used for both long term maintenance and field evaluation the length of the reproduction cycle is reduced for the museum collection. A banana museum collection may have a reproduction cycle of four years while a field evaluation collection may have one of two years. The combined museum and field evaluation collection has a two year cycle.

The aibika museum and field evaluation collection is separated into two sub-collections, the parent collection and the seedling collection. The parent collection was initially established by collection of varieties in farmers’ vegetable gardens, household gardens, the forest and the market place. The seedling collection was developed from seed produced by the parent collection fertilised by pollen

from unknown plant material. While plants in the seedling collection were produced from seeds produced by the parent material, it is likely that these accessions are different from those held in the parent collection, as daughter plants will do not breed true. The banana museum and field evaluation collection was also established with plant material from farmers' vegetable gardens, household gardens, the forest and the market place. Varieties collected for both collections were established in new gardens and evaluated to identify their characteristics (see Figure 11). The 'museum and field evaluation collection' is maintained as vegetative material in the fields. Prior to harvesting of vegetative material, land is prepared for the establishment of new gardens. As soon as the plants are harvested, the plant material is transferred to the new gardens (see Figure 5). There are three evaluation stages: initial field evaluation, secondary field evaluation and final field evaluation (Figure 11). In all stages research officers check that varieties do not already exist in the 'museum and field evaluation' collection and discard any duplicated material. If the varieties are not currently maintained in the museum and field evaluation collection and do not display sufficient desirable qualities, then the material remains in this collection. Following the final field evaluation research officers determine if the material is discarded, released to farmers or left in the museum and field evaluation collection.

3.2 Cost Budgeting

Spreadsheets were used to develop cost budgets to estimate the total cost of maintaining key germplasm collections detailed in Section 3.1 and the total cost of maintaining all collections. From information outlined in Section 3.1 and highlighted by flow charts in Figures 4, 10 and 11, each of the germplasm collections has significantly different characteristics. Hence, although a general spreadsheet is discussed in Section 3.2.1 each individual spreadsheet has unique characteristics.

3.2.1 Budget Structure

Each cost budget has three sections: (i) the summary table; (ii) key variables; and (iii) estimation of variable costs.

Summary tables outline the variable costs for station activities conducted to maintain plant germplasm collections. They also permit users to examine the cost budget without having to view the entire spreadsheet. A summary of station activities is provided in the first column of each table. Station activities are separated into four groups: land preparation, planting and replanting, crop maintenance and harvesting. These activities are conducted once every reproduction cycle and the combination of activities varies for each collection because of differences in the collection's characteristics. The summary table provides values estimating the annual variable cost per activity and the total annual cost for the collection. Other values reported include the total annual cost per accession (as well as the variable cost for each activity per accessions), and the total annual cost per plant (mound or station). Because of the characteristics of collections (see Section 3.1), values calculated for individual cost budgets differ.

Key variables are those important factors identified by PNG officers and are included in the spreadsheet to estimate the total cost of maintaining hypothetical collections. Hypothetical collections are fictional collections, for which it would be useful to estimate the total cost of maintaining the collection. Hence they have a different size or are maintained for a longer period of time. A list of all key variables is provided in Table 2. Since each collection has different characteristics, the combination of key variables used in each spreadsheet varies. Two sets of key variables, key variables for the 1997 germplasm collection, and key variables for the hypothetical germplasm collection, were included in each cost budget. Values in the first set are fixed and used

to estimate the variable ‘rate’ outlined below. The second set of key variables allows adjustments in key variables to estimate variations in total cost. For example if the number of accessions maintained increases, the total area of the collection and the total cost of maintaining the collection increases.

The key variables in each group are similar except that the second group contains a variable for the planting density and the length of the reproduction cycle, which is omitted from the first. The planting density is estimated as the number of plants per hectare for the taro, aibika and banana germplasm collections and the number of mounds (or stations) per hectare for sweet potato. Formulae for estimating the total area and the rate are included in the second set of key variables. Total area is estimated as the number of plants divided by the planting density as illustrated in (equation 1)). For sweet potato collections this is the number of mounds (stations) divided by the planting density.

$$\text{Total Area} = \frac{\text{Number of Accessions} \times \text{Number of Plant Replicates}}{\text{Planting Density}} \quad (1)$$

This formula was included since PNG officers indicated that station agronomists are likely to adjust the planting density to determine the total area, but the area is never directly adjusted. Thus if the number of accessions increases, the total area required to maintain the collection increases as represented in equation (1).

Formulae developed to allow changes in the length of the reproduction system are linked to the summary spreadsheet. For example the taro museum collection is currently maintained for six months. In the summary table the total cost per reproduction cycle is divided by the length of the reproduction cycle to provide the total cost per year.

Estimation of total variable costs requires data on input used including: the frequency of use, the total quantity of an input applied and the price paid per unit, for each station activity. To estimate proportionate adjustments in the total cost, formulas were established in the spreadsheets. A variable called ‘rate’ was established in each cost budget as the total quantity of an input applied divided by the appropriate key variable (equation 2).

$$\text{Rate} = \frac{\text{Total Quantity of Input Applied}}{\text{Appropriate Key Variable for the Germplasm Collection, 1997}} \quad (2)$$

Key variables selected for equation (2) from the first set of key variables depended on factors that affect the total maintenance cost of an activity. For example if the number of maintained accessions increases, assuming that the planting density remains constant, the area required to maintain the collection increases and there is an increase in the cost of land preparation. Table 3 outlines key variables used in the taro museum collection and shows that the total cost of plant rescue varies with the number of plants rescued, not the total area. Plant rescue occurs if plant material fails to establish following transplantation. Another equation is developed for ‘total cost’, which estimates as the product of frequency, rate, price and an appropriate key variable from the second group of key variables.

3.2.2 Master spreadsheet

The master spreadsheet may also be separated into three sections (i) the information framework; (ii) cost budgets and; (iii) the results. The information framework is a spreadsheet designed to link

each of the cost budgets together through 'key variable in the abstract germplasm collection'. Using this spreadsheet any user may adjust key variables of particular collections to answer 'what if' questions. After the specifications of the collection (number of accessions, number of plant replicates and planting density) are entered into the information framework, a result table is produced. Values are given for the annual total cost of maintaining the collection, maintaining an accession, maintaining a plant (mound or station) and maintaining all collections.

3.3 Data requirements

To determine data requirements for cost budgets PNG officers, who maintain the four crops, listed station activities conducted to maintain germplasm collections. Data were initially collected during the first field trip at Bubia in February 1997 and preliminary cost budgets prepared. These were later updated during a second field trip in May 1997.

Data for station activities include: (i) frequency of application (number of times an activity is conducted); (ii) total quantity applied (unit(s) applied); (iii) price (Kina per unit) of the input (e.g. cost of labour or chemicals for all station activities); and (iv) key variables. Data provided for (i) and (ii) represents the amount each for a reproduction cycle, for example the total quantity applied per reproduction cycle. Summaries of the data, for each collection, are displayed in Tables 4 to 12.

Each table shows data for the relevant key variables and other statistics, including the total quantity applied (no. of units), average price of the input (Kina/unit) and total cost (Kina). As shown in the table different groups of key variables are included in the cost budget for each germplasm collection. Other statistics include labour, materials (fuel, tractor hire and other materials) and chemicals (fungicides, insecticides, chemical and organic fertilisers and herbicides).

Summary statistics indicate that the sweet potato field evaluation collection at HAES requires the most resources. Only in the cases of fuel used for the banana germplasm collection, and insecticides for the taro museum collection, are the total quantities higher than those for the sweet potato germplasm collection (Table 9). Because of the distinct wet and dry season at Laloki, irrigation is necessary to maintain both banana and aibika germplasm collections. From a total of 536 litres of fuel used to maintain the banana germplasm collection, 525 litres are used in irrigation. Pumped irrigation using mains electricity is provided for the aibika germplasm collection. Data for these costs are currently unavailable as a lump sum payment is made for all electricity used by the research station. The average price of labour is about K 5.00/manday at Bubia, HAES and LAES; the price in LARS is considerably higher at K12.00/manday. The average price of fuel in each research station is K0.6/litre. The average price of chemicals varies because of the many different types of chemicals used to maintain these collections. Labour is the input with the highest total quantity applied and highest total cost for all collections. Chemicals are the next most expensive input for collection maintained at Bubia and HAES and likewise materials for collections maintained at LAES and LARS.

Data collected and incorporated into the cost budgets for taro and sweet potato are limited to the costs of materials used to maintain the crop in the current reproduction cycle. Similar information was collected for the aibika and banana germplasm collections, plus data for stationery and materials. These are variable cost as they may be applied for between two and ten reproduction cycles. Stationery and materials are considered variable costs if used within 5 years of purchase.

3.4 Results

3.4.1 Results table

The “results table” reports the total cost of maintaining germplasm collections for the four crops in PNG as K37 568 (see Table 13). The total maintenance cost per year is highest for the sweet potato field evaluation collection at HAES, and is lowest for the field evaluation collection at LAES. Total maintenance costs per accession are estimated for all germplasm collections except the taro museum collection maintained at BARC, the sweet potato museum collection maintained at HAES and the sweet potato field evaluation collection maintained at the High-Altitude Agriculture Experimental Station. Total costs per accession cannot be estimated due to the nature of these collections. For the taro breeding and field evaluation collection, 10 000 plants were initially established for the taro breeding and evaluation program, but at formal evaluation (see Figure 4) 40 accessions remain. The breeding process involves transition from maintenance of non-evaluated plants, to newly evaluated accessions. In the second case, 20 per cent of the 1158 mounds maintained in the sweet potato museum collection at HAES are duplicates. Finally, the sweet potato field evaluation collection is divided into 58 accessions and 11 mounds containing an identical variety. Because of these characteristics it is difficult to estimate the total cost per accession. Results for the total cost of maintaining a plant (mounds or accession) are highlighted in the second last row of Table 13. The total cost of maintaining a plant is assumed comparable to the cost of maintaining a station or mound. Table 13 shows the highest cost as K6.84 per plant for the taro breeding and field evaluation collection, and the lowest cost is K0.20 for the sweet potato field evaluation germplasm collection at HAES.

PNG officers from LAES reported that the total cost of maintaining ridges is lower than the total cost of maintaining mounds (see Section 3.2). Estimated costs confirm that the total cost of maintaining a station is greater than the total cost of maintaining a mound. As indicated in Section 3.2, the sweet potato museum collection maintained at HAES has not been removed since establishment in 1987. Station activities included in total maintenance costs are limited to weeding and application of herbicides, hence significantly reducing the cost of maintaining mounds as estimated for other collections, although this value is still larger than for maintaining ridges. It is likely that the total cost of maintaining mounds is greater than for maintaining ridges even when depreciation costs of machinery are included in the cost budgets.

3.4.2 Scenario analysis

Using the master spreadsheet to simulate costs, as illustrated in Table 13, the cost of maintaining different forms of collections may be examined. These different collection forms might include different numbers of accessions; different numbers of plants per accession; different plant husbandry practices; different length of growing period. The following scenarios are examined in this paper:

- . increase in the number of accessions maintained for the taro museum collection at BARC.
- . decrease in the number of plant replicates for the banana museum and field evaluation collection maintained at LARS.
- . increase in the length of the reproduction cycle for both collections in the sweet potato field evaluation collection maintained at HAES.

An increase in the number of accessions maintained in any collection will increase the total area and total cost of maintaining that collection. For example, suppose the number of accessions maintained in the taro museum collection at BARC increased from 310 to 400; the total area required to maintain the collection increases from 0.21 ha to 0.27 ha. The total cost of maintaining

the collection increases from K4120 to K5350; since the technology of the collection remains unchanged, the cost per accession and per plant remain unchanged at K13.30 and K1.33 respectively (Table 14).

A decrease in the number of plant replicates in a collection will decrease the size, the total area and total cost of maintaining the collection. If the number of plant replicates for the banana museum and field evaluation collection maintained at LARS decreases from two to one, the total area used to maintain the collection decreases from 0.36 ha to 0.18 ha, the total cost decreases from K4290 to K2720, the total cost of maintaining an accession decreases from K10.84 to K5.42, and the total cost of maintaining a plant remains constant at K5.42 (Table 15).

Increasing the length of the reproduction cycle for both collections in the sweet potato field evaluation collection maintained at HAES, decreases the cost per year. For example, if the length of the reproduction cycle is increased from six months to one year, the cost of maintaining the collection decreases from K12 970 to K6480 per year. Similarly other values for the sweet potato field evaluation collection at HAES, as shown in, decrease and the total cost of maintaining all collections falls (Table 16).

The master spreadsheet is useful for estimating the cost of maintaining germplasm collections but does not provide the optimal specification for collections subject to a given budget.

3.5 Tissue Culture

Three crops—namely sweet potato, banana and taro—are maintained using tissue culture at LAES. Maintenance of plant germplasm as tissue culture is a process where plants are stored in test tubes or small jars under controlled conditions. This technique is useful as it decreases the demands on land, involving the substitution of other capital for land, and skilled labour for field labour. Other advantages of maintaining germplasm collection in tissue culture are that material may be rapidly multiplied, plants are protected from unfavourable environmental conditions, field infections are avoided, and there is a constant supply of plant material when farmers' varieties are lost. However there are also some problems associated with use of tissue culture. The technique requires intensive use of capital which is expensive for less developed countries. Microbial contamination also poses problems, resulting in contamination and loss of current varieties in less than ideal conditions. Finally genetic instability *in vitro* may also result in loss of varieties (Jarret, 1990).

The flow chart in Figure 12 illustrates the process required to develop sweet potato tissue culture in PNG. After the process is initiated the growth medium is prepared using pre-specified ingredients and transferred to petri dishes. Concurrently scientists determine if plant material needs to be pathogen tested. If this testing is required, the plant material is sent to Australia. If plant material is to be subcultured, the material is transferred into vessels and placed in storage frames; otherwise the plant material is sub-divided and transferred to vessels. When established in vessels the tissue culture is checked regularly to ensure that plants remain clean; if it is impossible to clean the plants then they are disposed of. The cycle is repeated when plants become too large and are ready for further division.

A first attempt made by scientists at LAES to estimate the total cost of producing sweet potato tissue culture, and the results, are reported in Table 17. Three inputs are included in this estimation: energy requirements, materials and labour. Total costs were initially estimated as K520/month (or per 2200 plants), corresponding to a total cost per year of K6246, a cost per plant of K23.69. Compared to the maintenance costs per plant of field collections ranging K0.20-6.84, tissue culture costs appear to be substantially higher.

4. Programming solutions

The cost analysis presented in section 3 is essential for understanding the nature of the economic problem of germplasm conservation in PNG. Even without explicit empirical data on the value of conserved plant germplasm, decision makers may investigate the costs of different configurations of individual collections, or the aggregate costs of maintaining different numbers or types of collections. Ultimately, however, it would be desirable to investigate the net benefits of maintaining collections, and even the optimal size of both individual and aggregate collections. These issues are investigated in this section. The preceding cost analysis, and the scenario analysis possible from considering different configurations of collections and their technologies, is an essential aspect of obtaining programming solutions.

4.1 Linear/integer programming

The germplasm conservation problem may be conceptually represented as a conventional maximisation problem:

$$\begin{aligned} & \text{maximise } \sum_i \sum_k \sum_q Z_{ikq} \cdot (DPV_{iq} - c_{ik}) & (3) \\ & \text{wrt } Z_{ikq} \\ & \text{subject to } \sum_i \sum_k \sum_q Z_{ikq} \cdot c_{ik} < C \end{aligned}$$

where

index i: plant types (sweet potato, taro, banana, aibika)

index k: technology of maintaining collection (includes location)

index q: category of accessions in collection for plant type i

Z_{ikq} : = 1 if category q of accessions in plant type i using technology k is chosen, and = 0 otherwise

c_{ik} = cost of maintaining a collection of crop type i by technology k for a category of accessions (= number of accessions in a category x number of plants per accession x cost per plant)

DPV_{iq} is the discounted expected gross return from obtaining yield gain g_{iq} via maintaining the accessions in category q:

$$DPV_{iq} = \sum_t (1+g_{iq}) \cdot p_{iq} \cdot y^* \cdot A \cdot (py-c) \cdot (1/(1+r)^t) \quad (4)$$

where y^* is the existing yield, A is the area sown to the plant kind, $(py-c)$ is the long-run gross margin and r is the discount rate; $t = 1, 2, \dots$

C is an overall budget constraint for germplasm collections.

The constraints of this optimisation problem might include some arbitrarily-determined minimum number of varieties in each collection; labour availability; land availability; and annual budgeted expenditure. Except for the case of minimum varietal numbers, and possible seasonal constraints on labour availability on research stations, the constraints of this problem effectively collapse into the single constraint of annual budgeted expenditure.

Even if this problem is collapsed into one with a single constraint, the determination of a solution depends on obtaining estimates of the value of germplasm. The remainder of this section is devoted to exploring this issue.

In the following discussion, it is assumed that “yield” is the only desirable trait in crops. Consider the existing holding of germplasm. For given resources in plant improvement (plant selection or breeding), this germplasm stock may result in future improvement in yield. Because there is a considerable element of chance involved in obtaining new varieties, the future yield gain is a random variable (cf. Evenson and Kislev 1975):

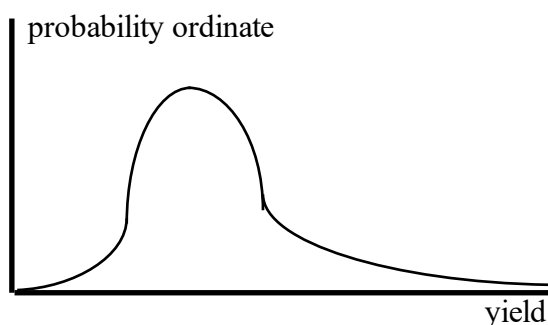

If larger collections have greater value than smaller collections, then larger collections would have probability distributions of yield that “dominate” smaller collections. However, these distributions are presently unknown, and a simpler discrete approach to the problem is presented.

How large should a germplasm collection be? Consider a crop type i ; and divide its germplasm collection into quartiles. Quartile Q_{i1} comprises the “best” 25% of accessions, i.e. those most likely to contribute to increasing yield; quartile Q_{i2} comprises the “second-best” 25% of accessions; quartile Q_{i3} comprises the “third-best” 25% of accessions; and quartile Q_{i4} comprises the “worst” 25% of accessions. For each quartile q , ask for an assessment of the most likely contribution of accessions in this quartile to increasing yield in the next 10 years (in proportional terms g_{iq}), and the corresponding probability of obtaining *at most* this increased yield arising from plant breeding or selection based on these accessions (p_{iq}) [or, alternatively, (1-probability of obtaining *at least* this yield)]. Thus:

Quartile	Q_{i1}	Q_{i2}	Q_{i3}	Q_{i4}
Proportional yield gain	g_{i1}	g_{i2}	g_{i3}	g_{i4}
Probability of yield gain	p_{i1}	p_{i2}	p_{i3}	p_{i4}

where $p_{iq} = \text{prob.}(g_{iq})$. The value of $\text{cov}(g_{iR}, g_{iS})$ is unknown and $\text{cov}(g_{iR}, g_{iS})$ may be non-zero; in this case, the problem would be non-linear programming.

The values of g_{ij} and p_{ij} are currently unknown; it is proposed to obtain these values by survey for which a questionnaire has been designed and a population of respondents partially identified. Without this data it is not possible to proceed empirically to obtain estimates of optimal collection size. In the interim, a breakeven analysis is presented below of the relationship between g_{ij} and p_{ij} which ignores the implications of constrained optimisation in the above programming problem. This analysis involves searching for the values of g_{ij} and p_{ij} for which the maximand in equation (3) equals zero. Thus, for each individual collection:

$$p_{iq} = c_{ik} / [(1+g_{iq}) \cdot y^* \cdot A \cdot (p_y - c) \cdot \sum_t (1/(1+r)^t)] \quad (5)$$

Using values of c_{ik} from section 3, and best estimates of the other variables (y^* , A , p_y , c and r), the breakeven relationship between g_{ij} and p_{ij} is shown in Table 18.

4.2 Dynamic programming

Godden, Kennedy and Kambuou (1997) outlined a stochastic dynamic programming model of plant germplasm maintenance and breeding, and Kennedy, Godden and Kambuou (1997) have refined this model. The model has the following structure:

1. objective function: expected value of net revenue over all future periods.
2. state variables: the current number of accessions (a) and crop yield (y).
3. decision variables: annual expenditure on maintaining germplasm (m) and annual expenditure on plant breeding (b). The probability of germplasm accessions being maintained or increased is positively related to the level of m ; and the probability of preventing crop yield declines or obtaining improved varieties is positively related to the level of b . The corresponding state transition probabilities are:

$$\begin{aligned} \text{Pr}^a \{a_i | a, m_f\} & \quad \text{probability of attaining in } T \text{ years accession numbers } i \text{ given} \\ & \quad \text{current accession numbers } a \text{ and maintenance expenditure } m_f \\ \text{Pr}^Y \{y_j | a, y, b_g\} & \quad \text{probability of attaining in } T \text{ years yield } j \text{ given current accession} \\ & \quad \text{numbers } a \text{ and breeding expenditure } b_g \end{aligned}$$

4. decision interval: T years, the length of the breeding cycle from first crossing to varietal release.
5. stage returns:

$$\pi \{y, y_j, p, r, t\} = p \cdot \sum ((ty_j + (T-t)y)/T) \cdot (1+r)^{-t} \quad \text{for } t = 1, \dots, T \quad (6)$$

for pre-diffusion yield (y), new yield (y_j), crop price (p) and annual discount rate (r).

6. solution procedure: since all model parameters and functions are identical for all decision stages the problem is stationary. With an infinite planning horizon, the optimal decision vector in state space for any decision stage is identical, and so is the value of the system defined as $V \{a, y\}$. Even with an infinite planning horizon, $V \{a, y\}$ is finite because stage

returns are discounted. The solution procedure is to find the decision vector in state space which satisfies the recursive functional equation:

$$V\{a,y\} = \max_{m_f, b_g} [\sum_i \sum_j \Pr^a\{a_i|a,m_f\} \cdot \Pr^y\{y_j|a,y,b_g\}(-\beta(m_f + b_g) + \alpha((\pi\{y,y_j,p,r,t,T\}-\beta c)h + V\{a_i,y_j\}))] \quad I = 1, \dots, I; \quad j = 1, \dots, J \quad (7)$$

Numerical solutions to equation (7) were obtained using menu-driven general purpose dynamic programming routines coded in Turbo Basic (Kennedy 1986, 1989).

Kennedy, Godden and Kambuou (1997) derived a solution for the problem of taro germplasm maintenance and breeding in PNG given the best available current data.

5. Conclusion

The management of plant germplasm collections can be represented as an economic decision problem. The objective of this problem is the maximisation of net economic benefits defined as the net value of improved plant production based on new varieties whose existence depended on germplasm conservation and the costs of maintaining these collections. The benefits of maintaining these collections may be difficult to estimate, and a variety of approaches to evaluating the net benefits of maintaining collections may be utilised (section 2). The variable costs of maintaining field collections of four important food crops in Papua New Guinea—aibika, banana, sweet potato and taro—is presented in section 3 for a variety of sites and collection types. These costs may be used together with local scientific knowledge to investigate the budgetary consequences of varying the current collections. Programming approaches to investigating resource use in plant germplasm collections were outlined in section 4. A simple linear programming model (section 4.1) indicates the decision framework required, and especially the type of data about the benefits of maintaining collections in terms of possible effects on future plant yield. A simple breakeven analysis was used to indicate that, even if the probability of future yield gains from retaining collections was low, quite small yield increases were sufficient to make retention of the collections economic. Stochastic dynamic programming analysis confirms that retention of collections is likely to be economic in the case of taro.

The principal future need is for good information on the likely future benefits of maintaining crop plant germplasm collections, and current research is devoted to this objective.

References

- Evenson, R.E. and Kislev, Y. (1975), *Agricultural Research and Productivity*, chapter 8: A Simple Model of Technological Research, Yale University Press, New Haven and London.
- Godden, D.P. and Kambuou, R.N. (1996), Making Nature Pay: economics of plant germplasm in Papua New Guinea, Annual Conference Australian Agricultural and Resource Economics Society, University of Melbourne, 13–15 February.
- Godden, D. and Kambuou, R. (1996), Storing Future Harvests: economic aspects of plant germplasm collections in Papua New Guinea, Voices from the Commons: Sixth Annual Common Property Conference of the International Association for the Study of Common Property, Berkeley, California, 5-9 June.
- Godden, D., Kennedy, J. and Kambuou, R. (1997), Economic modelling of plant germplasm collections in Papua New Guinea, Annual Conference, Australian Agricultural and Resource Economics Society, Gold Coast, January.
- Guaf, E. (1997), Personal Communications, Curator of Lowlands Sweet Potato Collections, Lowlands Agricultural Experiment Station, Department of Agriculture and Livestock, Keravat, 20/05/97.
- Ivancic, A. (1995) Taro on New Guinea Islands, Report on Tour Across New Guinea Islands, 11-28 July, Principal Taro Breeder at Bubia Agricultural Research Centre, Papua New Guinea.
- Jarret, R.L. (1990), In vitro Active vs. Field Genebank Maintenance of Sweet Potato Germplasm: Major Cost and Consideration, *Horticultural Science*, 25(2), 141-146.
- Kambuou, R.N. (1995), *Country Report: Papua New Guinea*, International Conference and Programme for Plant Genetic Resources, roneo.
- Kanua, M.B. and Rangaii, S.S. (1988), Indigenous Technologies and Recent Advances in Sweet Potato Production, Processing, Utilisation and Marketing in Papua New Guinea, International Sweet Potato Symposium, Philippines, May.
- Kennedy, J.O.S. (1986), *Dynamic Programming: applications to agriculture and natural resources*, Elsevier Applied Science, London.
- Kennedy, J.O.S. (1989), *General Purpose Dynamic Programming Manual*, Department of Economics, La Trobe University, Melbourne.
- Kennedy, J., Godden, D. and Kambuou, R. (1997), Optimal management of plant germplasm collections in Papua New Guinea, Fourth Conference, Association of Asian-Pacific Operational Research Societies, Melbourne, 30 November-4 December [Internet address: <http://mundoe.maths.mu.oz.au/~worms/apors/apors.html>].
- Risimeri, J. (1997), Personal Communications, Senior Agronomist, Bubia Agricultural Research Centre, Department of Agriculture and Livestock, Lae.

Figure 1: Integrated Model of Germplasm Conservation and Plant Improvement

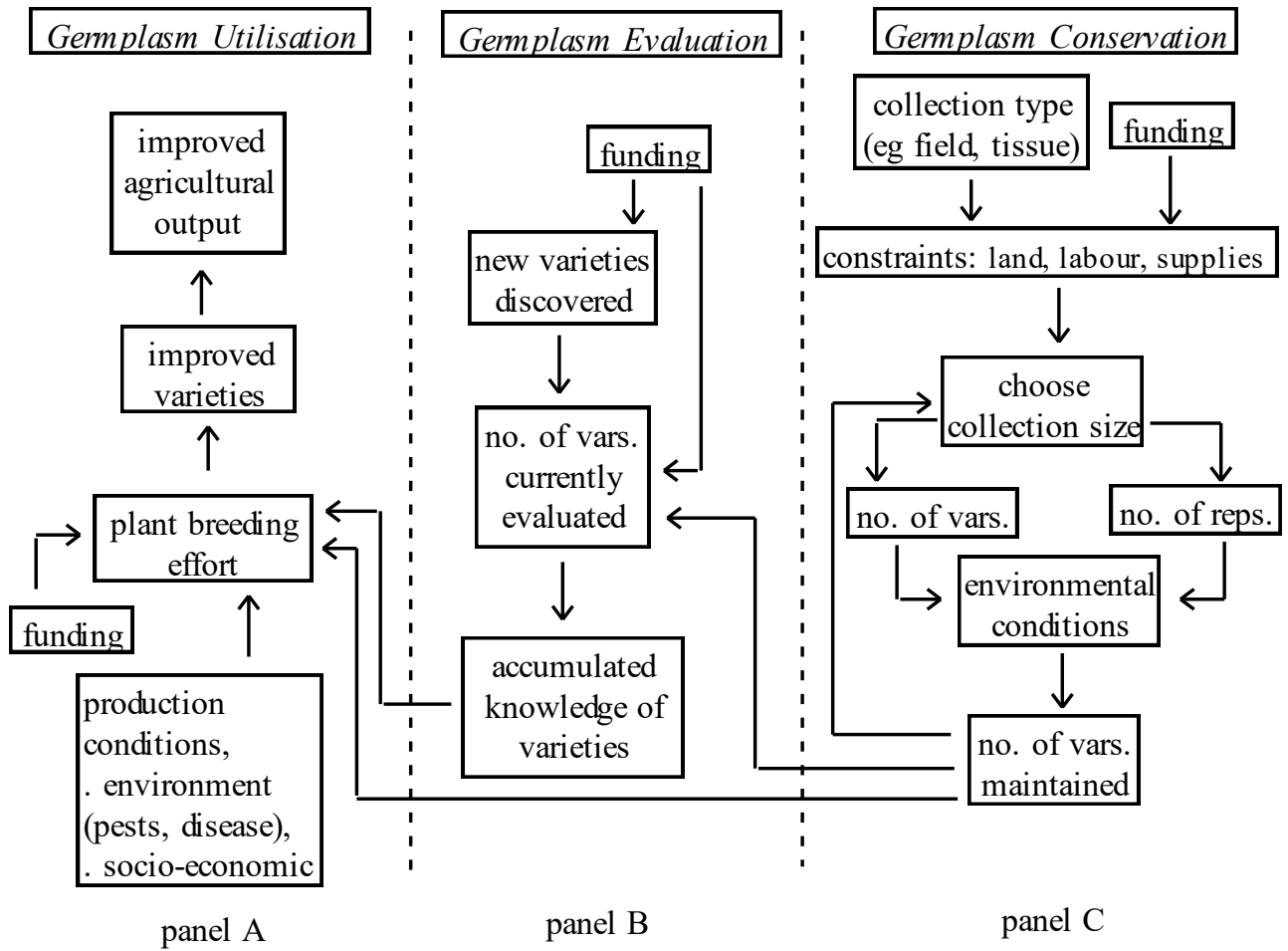

Figure 2: Decision Framework for Germplasm Conservation

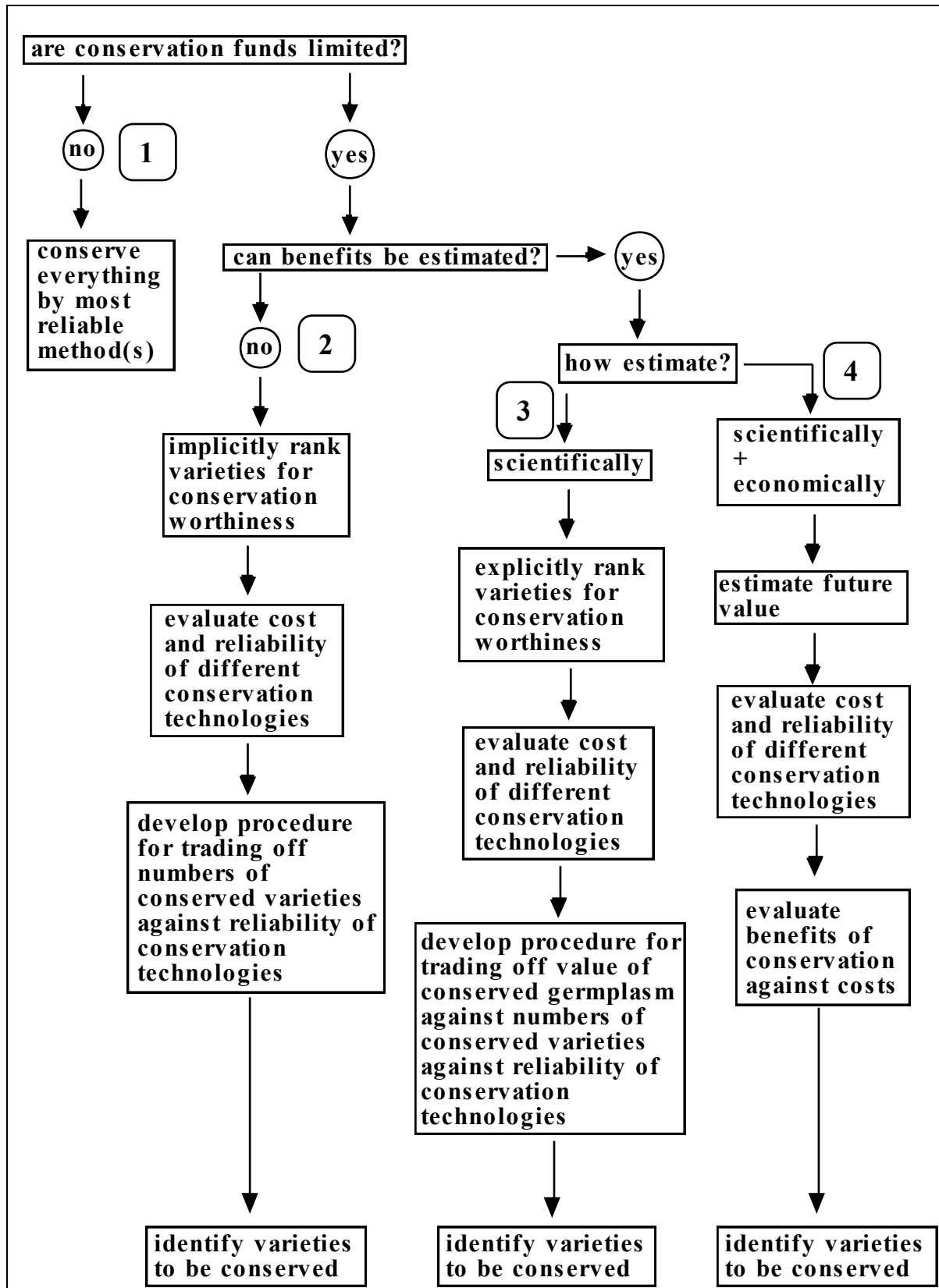

Figure 3: Plant Germplasm Conservation Production Process

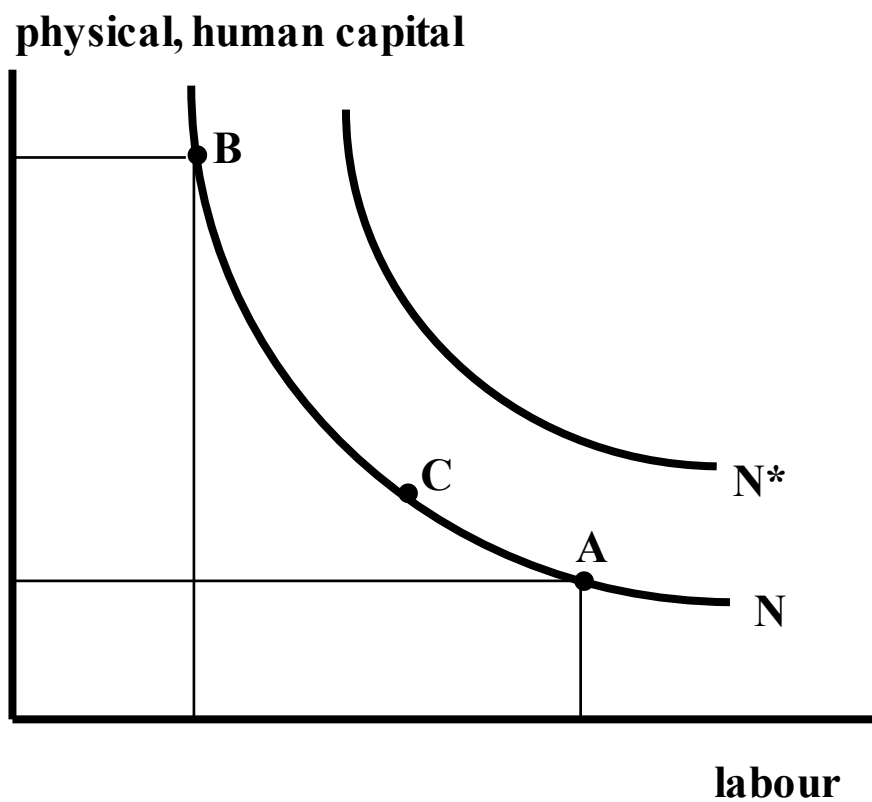

Figure 5: Transferring Aibika, Banana or Taro Plant Material

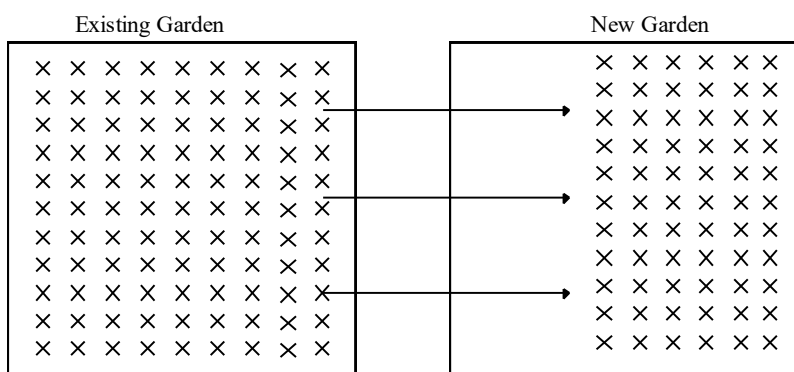

Figure 6: Diagram representing a Mound, Station and Plants.

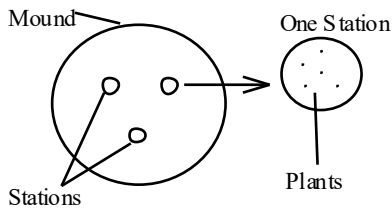

Figure 7: Diagram Representing Ridges, Stations and Plants

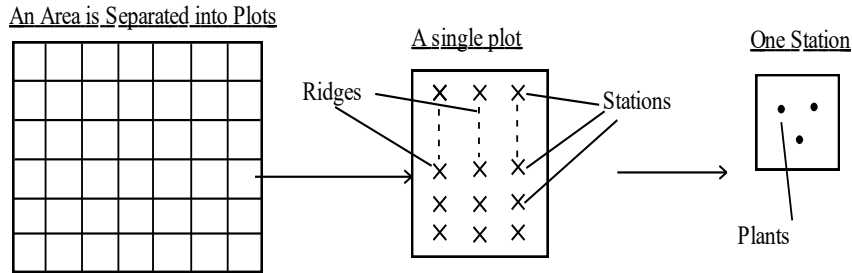

Figure 8: Diagram representing field Evaluation Collections in the Highlands.

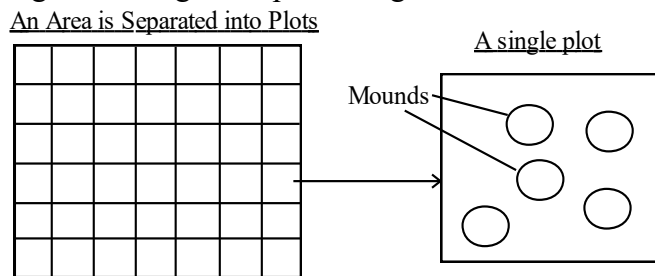
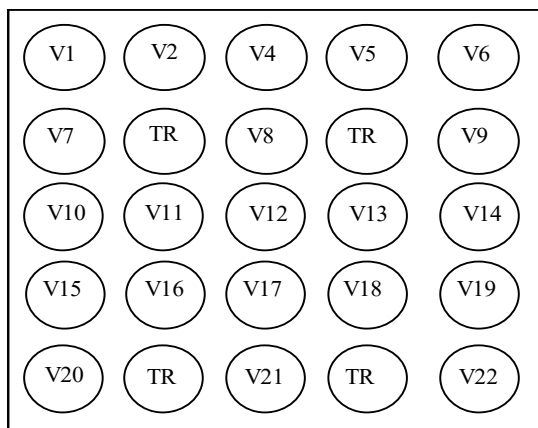

Figure 9: Representation of the Field Evaluation Collection at the High-Altitude Research Station.



V1 is variety one, V2 is variety two,.....
 TR is a traditional cultivar

Figure 12: Flow Chart for the Long Term Maintenance of Sweet potato In-Vitro Collections

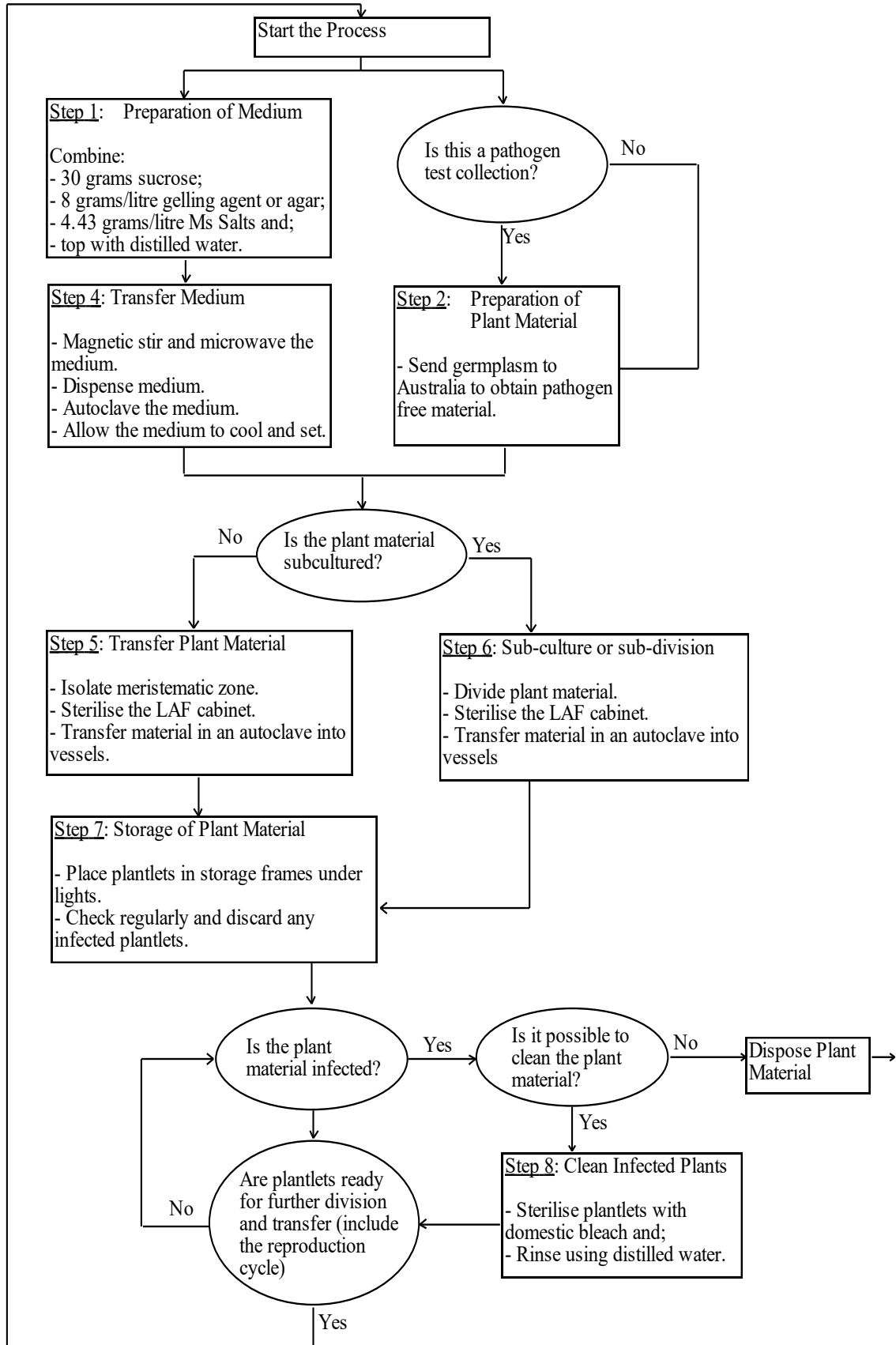

Table 17: Statistics for the Total Cost of Producing Sweet Potato Tissue Culture

Input	Total Maintenance Cost (Kina/year)	Total Maintenance Cost (Kina/month)	Total Cost per Plant (toea)
1. Electricity Requirements			
Illumination	298.08	24.84	1.13
Cooling	26.40	2.20	0.10
Media Preparation	62.04	5.17	0.24
2. Materials			
Medium	1193.28	99.44	4.52
Culturing Vessels	607.20	50.60	2.30
Laminar Flow Box	105.60	8.80	0.40
Other Costs	264.00	22.00	1.00
3. Labour	3690.00	307.50	14.00
Total Cost	6246.60	520.55	23.69

Source: Guaf (1997, pers. comm.)

Table 18: Breakeven Analysis for Two Crop Germplasm Collections

Sweet Potato		Taro	
area (ha) =	103870	area (ha) =	32300
yield (t/ha) =	4.41	yield (t/ha) =	6.76
price (K/kg) =	0.3	price (K/kg) =	0.5
growing costs (K/ha) =	1289	growing costs (K/ha) =	2030
costs (K/kg)=	0.29	costs (K/kg)=	0.30
collection costs (K) =	3458	collection costs (K) =	8320
r=	0.02	r=	0.02
net returns (K/year)	3531.58	net returns (K/year)	43605
discount factor	50	discount factor	50
expected gain	breakeven probability	expected gain	breakeven probability
0.005	0.019	0.005	0.0046
0.010	0.019	0.010	0.0046
0.015	0.019	0.015	0.0046
0.020	0.019	0.020	0.0046
0.025	0.019	0.025	0.0046
0.030	0.019	0.030	0.0046
0.035	0.019	0.035	0.0046
0.040	0.019	0.040	0.0046
0.045	0.019	0.045	0.0046
0.050	0.019	0.050	0.0046
0.055	0.019	0.055	0.0046
0.060	0.018	0.060	0.0046
0.065	0.018	0.065	0.0046
0.070	0.018	0.070	0.0046

$$cik / [(1+giq).y*.A.(py-c).\sum t (1/\{[1+r]t\})]$$